

Panasonic[®]

Operating Instructions

Digital Cordless Phone

Model No. **KX-TG6551BX**

Digital Cordless Answering System

Model No. **KX-TG6561BX**



Model shown is KX-TG6551.

Before initial use, see “Getting Started” on page 8.

Thank you for purchasing a Panasonic product.

Please read these operating instructions before using the unit and save them for future reference.

This unit is compatible with Caller ID. You must subscribe to the appropriate service offered by your service provider/telephone company.

**Please access our online customer survey:
<http://panasonic.net/pcc/tel/q>**

Table of Contents

Introduction	
Model composition	3
Accessory information	3
Important Information	
For your safety	5
Important safety instructions	6
For best performance	6
Other information	7
Specifications	7
Getting Started	
Setting up	8
Note when setting up	9
Controls	10
Display	11
Turning the power on/off	12
Initial settings	13
One touch eco mode	13
Wall mounting	14
Making/Answering Calls	
Making calls	15
Answering calls	16
Useful features during a call	16
Handset key lock	18
Handset Phonebook	
Handset phonebook	19
Base Unit Speed Dial	
Base unit speed dial	21
Programming	
Programmable settings	22
Special programming	27
Registering a unit	28
Caller ID Service	
Using Caller ID service	30
Caller list	30
Answering System	
Answering system	32
Turning the answering system on/off	32
Greeting message	33
Listening to messages using the base unit	33
Listening to messages using the handset	34
Remote operation	35
Answering system settings	36
Voice Mail Service	
Voice mail service	38
Intercom/Locator	
Intercom	39
Handset locator	39
Transferring calls, conference calls	39
Useful Information	
Character entry	41
Error messages	43
Troubleshooting	44
Index	
Index	49

Introduction

Model composition

Series	Model No.	Base unit	Handset	
		Part No.	Part No.	Quantity
KX-TG6551 series	KX-TG6551	KX-TG6551	KX-TGA651	1
KX-TG6561 series	KX-TG6561	KX-TG6561	KX-TGA651	1

- The answering system is only available for KX-TG6561 series.
- The suffix (BX) in the following model numbers will be omitted in these instructions:
KX-TG6551BX/KX-TG6561BX

Accessory information

Supplied accessories

No.	Accessory item/Part number	Quantity
①	AC adaptor/PQLV219BX	1
②	Telephone line cord	1
③	Rechargeable batteries ^{*1} /HHR-55AAAB or N4DHYYY00001	2
④	Handset cover ^{*2}	1

*1 See page 4 for replacement battery information.

*2 The handset cover comes attached to the handset.



Introduction

Additional/replacement accessories

Please contact your nearest Panasonic dealer for sales information.

Accessory item	Model number
Rechargeable batteries	HHR-4DPA or HHR-4MRT* ¹
	Battery type: – Nickel metal hydride (Ni-MH) – 2 x AAA (R03) size for each handset
DECT repeater	KX-A272

*1 Replacement batteries may have a different capacity from that of the supplied batteries.

Important Information

For your safety

To prevent severe injury and loss of life/property, read this section carefully before using the product to ensure proper and safe operation of your product.

WARNING

Power connection

- Use only the power source marked on the product.
- Do not overload power outlets and extension cords. This can result in the risk of fire or electric shock.
- Completely insert the AC adaptor/power plug into the power outlet. Failure to do so may cause electric shock and/or excessive heat resulting in a fire.
- Regularly remove any dust, etc. from the AC adaptor/power plug by pulling it from the power outlet, then wiping with a dry cloth. Accumulated dust may cause an insulation defect from moisture, etc. resulting in a fire.
- Unplug the product from power outlets if it emits smoke, an abnormal smell, or makes an unusual noise. These conditions can cause fire or electric shock. Confirm that smoke has stopped emitting and contact an authorised service centre.
- Unplug from power outlets and never touch the inside of the product if its casing has been broken open.
- Never touch the plug with wet hands. Danger of electric shock exists.

Installation

- To prevent the risk of fire or electrical shock, do not expose the product to rain or any type of moisture.
- Do not place or use this product near automatically controlled devices such as automatic doors and fire alarms. Radio waves emitted from this product may cause such devices to malfunction resulting in an accident.
- Do not allow the AC adaptor or telephone line cord to be excessively pulled, bent or placed under heavy objects.

Operating safeguards

- Unplug the product from power outlets before cleaning. Do not use liquid or aerosol cleaners.
- Do not disassemble the product.
- Do not spill liquids (detergents, cleansers, etc.) onto the telephone line cord plug, or allow it to become wet at all. This may cause a fire. If the telephone line cord plug becomes wet, immediately pull it from the telephone wall jack, and do not use.

Medical

- Consult the manufacturer of any personal medical devices, such as pacemakers or hearing aids, to determine if they are adequately shielded from external RF (radio frequency) energy. (The product operates in the frequency range of 1.88 GHz to 1.90 GHz, and the RF transmission power is 250 mW (max..))
- Do not use the product in health care facilities if any regulations posted in the area instruct you not to do so. Hospitals or health care facilities may be using equipment that could be sensitive to external RF energy.

CAUTION

Installation and location

- Never install telephone wiring during an electrical storm.
- Never install telephone line jacks in wet locations unless the jack is specifically designed for wet locations.
- Never touch uninsulated telephone wires or terminals unless the telephone line has been disconnected at the network interface.
- Use caution when installing or modifying telephone lines.
- The AC adaptor is used as the main disconnect device. Ensure that the AC outlet is installed near the product and is easily accessible.
- This product is unable to make calls when:
 - the handset batteries need recharging or have failed.
 - there is a power failure.
 - the key lock feature is turned on.

Important Information

Battery

- We recommend using the batteries noted on page 4. **USE ONLY rechargeable Ni-MH batteries AAA (R03) size.**
- Do not mix old and new batteries.
- Do not open or mutilate the batteries. Released electrolyte from the batteries is corrosive and may cause burns or injury to the eyes or skin. The electrolyte is toxic and may be harmful if swallowed.
- Exercise care when handling the batteries. Do not allow conductive materials such as rings, bracelets, or keys to touch the batteries, otherwise a short circuit may cause the batteries and/or the conductive material to overheat and cause burns.
- Charge the batteries provided with or identified for use with this product only, in accordance with the instructions and limitations specified in this manual.
- Only use a compatible base unit (or charger) to charge the batteries. Do not tamper with the base unit (or charger). Failure to follow these instructions may cause the batteries to swell or explode.

Important safety instructions

When using your product, basic safety precautions should always be followed to reduce the risk of fire, electric shock, and injury to persons, including the following:

1. Do not use this product near water for example, near a bathtub, washbowl, kitchen sink, or laundry tub, in a wet basement or near a swimming pool.
2. Avoid using a telephone (other than a cordless type) during an electrical storm. There may be a remote risk of electric shock from lightning.
3. Do not use the telephone to report a gas leak in the vicinity of the leak.
4. Use only the power cord and batteries indicated in this manual. Do not dispose of batteries in a fire. They may explode. Check with local codes for possible special disposal instructions.

SAVE THESE INSTRUCTIONS

For best performance

Base unit location/avoiding noise

The base unit and other compatible Panasonic units use radio waves to communicate with each other.

- For maximum coverage and noise-free communications, place your base unit:
 - at a convenient, high, and central location with no obstructions between the handset and base unit in an indoor environment.
 - away from electronic appliances such as TVs, radios, personal computers, wireless devices, or other phones.
 - facing away from radio frequency transmitters, such as external antennas of mobile phone cell stations. (Avoid putting the base unit on a bay window or near a window.)
- Coverage and voice quality depends on the local environmental conditions.
- If the reception for a base unit location is not satisfactory, move the base unit to another location for better reception.

Environment

- Keep the product away from electrical noise generating devices, such as fluorescent lamps and motors.
- The product should be kept free from excessive smoke, dust, high temperature, and vibration.
- The product should not be exposed to direct sunlight.
- Do not place heavy objects on top of the product.
- When you leave the product unused for a long period of time, unplug the product from the power outlet.
- The product should be kept away from heat sources such as radiators, cookers, etc. It should not be placed in rooms where the temperature is less than 0 °C or greater than 40 °C. Damp basements should also be avoided.
- The maximum calling distance may be shortened when the product is used in the following places: Near obstacles such as hills, tunnels, underground, near metal objects such as wire fences, etc.

Important Information

- Operating the product near electrical appliances may cause interference. Move away from the electrical appliances.

Routine care

- **Wipe the outer surface of the product with a soft moist cloth.**
- Do not use benzine, thinner, or any abrasive powder.

Other information

Notice for product disposal, transfer, or return

- This product can store your private/confidential information. To protect your privacy/confidentiality, we recommend that you erase information such as phonebook or caller list entries from the memory before you dispose of, transfer, or return the product.

Information on Disposal in other Countries outside the European Union



These symbols are only valid in the European Union. If you wish to discard these items, please contact your local authorities or dealer and ask for the correct method of disposal.

Specifications

- **Standard:**
DECT (Digital Enhanced Cordless Telecommunications),
GAP (Generic Access Profile)
- **Frequency range:**
1.88 GHz to 1.90 GHz
- **RF transmission power:**
Approx. 10 mW (average power per channel)

- **Power source:**
100–240 V AC, 50/60 Hz
- **Power consumption:**
Base unit:
Standby: Approx. 0.6 W
Maximum: Approx. 4.0 W
- **Operating conditions:**
0 °C – 40 °C, 20 % – 80 % relative air humidity (dry)

Note:

- Design and specifications are subject to change without notice.
- The illustrations in these instructions may vary slightly from the actual product.
- The range of the handset under maximum conditions is 60 metres indoors and 300 metres outdoors. Please note it will probably be shortened when near concrete barriers, etc.

Getting Started

Setting up

Connections

- Use only the supplied Panasonic AC adaptor PQLV219BX.

■ Base unit

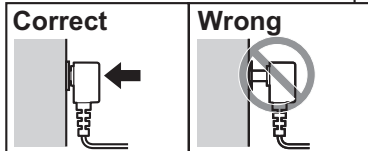
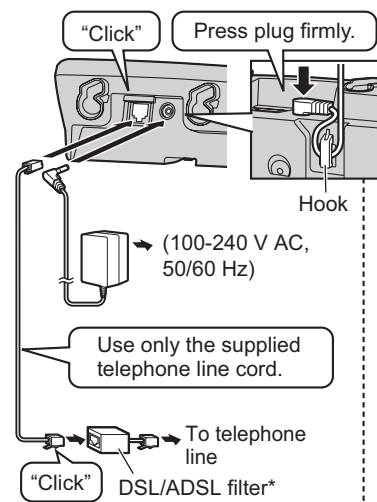

*DSL/ADSL filter (not supplied) is required if you have DSL/ADSL service.

Battery installation

- USE ONLY Ni-MH batteries AAA (R03) size.
- Do NOT use Alkaline/Manganese/Ni-Cd batteries.
- Confirm correct polarities (+, -).

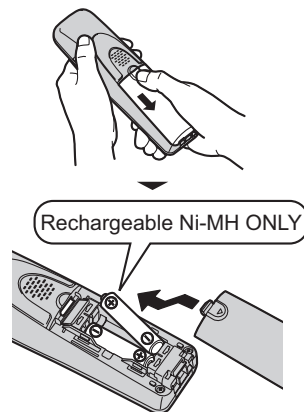

- When the language selection is displayed, see page 13.

Battery charge

Charge for about 7 hours.

- When the batteries are fully charged, the charge indicator goes off and "Fully charged" is displayed.

Charge indicator

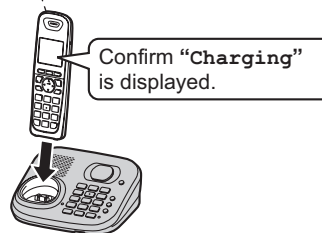

Getting Started

Note when setting up

Note for connections

- The AC adaptor must remain connected at all times. (It is normal for the adaptor to feel warm during use.)
- The AC adaptor should be connected to a vertically oriented or floor-mounted AC outlet. Do not connect the AC adaptor to a ceiling-mounted AC outlet, as the weight of the adaptor may cause it to become disconnected.

During a power failure

The unit will not work during a power failure. We recommend connecting a corded-type telephone (without AC adaptor) to the same telephone line or to the same telephone line jack using a T-adaptor.





Note for battery installation

- Use the supplied rechargeable batteries. For replacement, we recommend using the Panasonic rechargeable batteries noted on page 4, 6.
- Wipe the battery ends (⊕, ⊖) with a dry cloth.
- Avoid touching the battery ends (⊕, ⊖) or the unit contacts.

Note for battery charge

- It is normal for the handset to feel warm during charging.
- Clean the charge contacts of the handset, base unit, and charger with a soft and dry cloth once a month. Clean more often if the unit is exposed to grease, dust, or high humidity.

Battery level

Icon	Battery level
	High
	Medium
	Low
	Needs charging.

Panasonic Ni-MH battery performance (supplied batteries)

Operation	Operating time
In continuous use	18 hours max.
Not in use (standby)	170 hours max.

Note:

- It is normal for batteries not to reach full capacity at the initial charge. Maximum battery performance is reached after a few complete cycles of charge/discharge (use).
- Actual battery performance depends on usage and ambient environment.
- Even after the handset is fully charged, the handset can be left on the base unit or charger without any ill effect on the batteries.
- The battery level may not be displayed correctly after you replace the batteries. In this case, place the handset on the base unit or charger and let it charge for at least 7 hours.

Getting Started

Controls

Handset

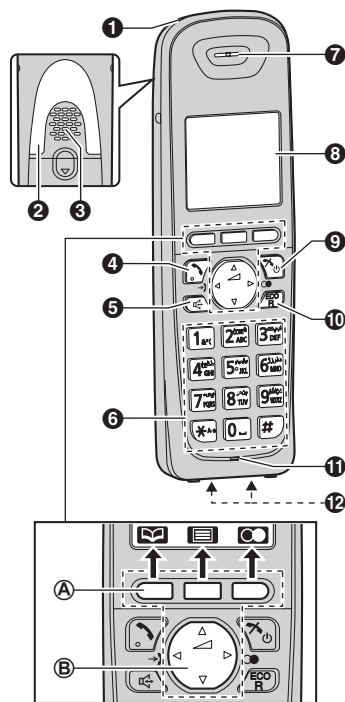

- 1 Charge indicator**
Ringer indicator
- 2 Secure grip**
 - Secure grip offers support when you cradle the handset between your shoulder and ear.
- 3 Speaker**
- 4 [↵] (Talk)**
- 5 [☎] (Speakerphone)**
- 6 Dial keypad**
- 7 Receiver**
- 8 Display**
- 9 [⏻] (Off/Power)**

- 10 [ECO/R]**
ECO: Eco mode shortcut key
R: Recall/Flash

- 11 Microphone**
- 12 Charge contacts**

Control type

A Soft keys

The handset features 3 soft keys. By pressing a soft key, you can select the feature shown directly above it on the display.

B Navigator key

- [▲], [▼], [←], or [→]: Scroll through various lists and items.
- [▲] (Volume: [▲] or [▼]): Adjust the receiver or speaker volume while talking.
- [←] (→): Caller list: View the caller list.
- [→] (☎): Redial: View the redial list.

Base unit

■ KX-TG6551

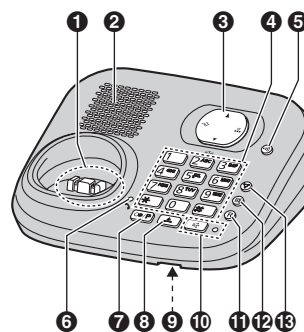

- 1 Charge contacts**
- 2 Speaker**
- 3 [▲]/[▼] (Volume up/down)**
[→] (Program)
[☎] (Speed dial)
- 4 Dial keypad**
- 5 [☎] (Locator/Intercom)**

Getting Started

- 6 In use indicator
- 7 [●/P] (Redial/Pause)
- 8 [↕] (Hold)
- 9 Microphone
- 10 [☎] (Speakerphone)
Speakerphone indicator
- 11 [R] (Recall/Flash)
- 12 [⊗] (Mute)
- 13 [▽] (Conference)

■ KX-TG6561

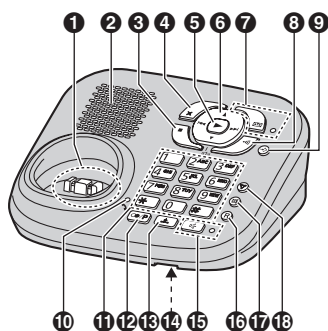

- 1 Charge contacts
- 2 Speaker
- 3 [■] (Stop)
- 4 [X] (Erase)
- 5 [▶] (Play)
Message indicator
- 6 [▲]/[▼] (Volume up/down)
[◀◀]/[▶▶] (Repeat/Skip)
- 7 [☎] (Answer on)
Answer on indicator
- 8 [☎] (Locator/Intercom)
- 9 [→] (Program/Speed dial)
- 10 In use indicator
- 11 Dial keypad
- 12 [●/P] (Redial/Pause)
- 13 [↕] (Hold)
- 14 Microphone
- 15 [☎] (Speakerphone)
Speakerphone indicator
- 16 [R] (Recall/Flash)

- 17 [⊗] (Mute)
- 18 [▽] (Conference)

Display

Handset display items

Item	Meaning
☎	Within base unit range
☎	Out of base unit range
☎	Paging, intercom mode.
☎	Speakerphone is on. (page 15)
☎	The line is in use. <ul style="list-style-type: none"> • When flashing slowly: The call is put on hold. • When flashing rapidly: An incoming call is now being received.
☎	Missed call ^{*1} (page 30)
ECO	The base unit transmission power is set to "Low". (page 13)
☎	The LCD and key backlight is off. (page 24)
☎	<ul style="list-style-type: none"> • When displayed next to the battery icon: Answering system is on.^{*2} (page 32) • When displayed with a number: New messages have been recorded.^{*2} (page 34)
☎	Answering system answers calls with a greeting message and caller messages are not recorded. ^{*2} ("Selecting "Greeting Only", page 37)

Getting Started

Item	Meaning
	Battery level
	Alarm is on. (page 27)
	Privacy mode is on. (page 25)
	Ringer volume is off. (page 26)
	Blocked call* ¹ , * ² (page 28, 30)
	New voice mail message received.* ³ (page 38)
Line in use	Someone is using the line.

*1 Caller ID subscribers only
 *2 KX-TG6561
 *3 Voice mail subscribers only

Soft key icons

Icon	Action
	Returns to the previous screen or outside call.
	Displays the menu.
	Accepts the current selection.
	Displays a previously dialed phone number.
	Makes a call. (page 15)
	Temporarily turns off the ringer for incoming calls. (page 16)
	Places a call on hold. (page 40)
	Opens the phonebook.
	Allows you to edit phone numbers. (page 28, 31)
	Adds new entry. (page 19, 28)

Icon	Action
	Displays the character entry mode for phonebook search. (page 19)
	Turns the key lock feature off. (page 18)
	Selects a character entry mode.
	Stops recording or playback.* ¹
	Stores phone numbers. (page 28, 31)
	Inserts a dialling pause.
	Erases the selected item or returns to the outside call.
	Allows you to make an intercom call. (page 39)
	Establishes a conference call. (page 39)
	Erases a number/character.
	Puts the call on mute.

*1 KX-TG6561

Turning the power on/off

Power on

Press [] for about 1 second.

Power off

Press [] for about 2 seconds.

Getting Started**Initial settings****Symbol meaning:**

Example: [▼]/[▲]: “off”

Press [▼] or [▲] to select the words in quotations.

Display language**Important:**

- When the language selection is displayed after installing the batteries for the first time, perform step 2.

3 display languages are available. You can select “English”, “العربية”, or “فارسی”.

- 1  → [#][1][1][0]
- 2 [▼]/[▲]: Select your desired language. → **OK** → [↵]

Dialling mode

If you cannot make calls, change this setting according to your telephone line service. The default setting is “Tone”.
 “Tone”: For tone dial service.
 “Pulse”: For rotary/pulse dial service.

- 1  → [#][1][2][0]
- 2 [▼]/[▲]: Select the desired setting. → **OK** → [↵]

Date and time

- 1  → [#][1][0][1]
- 2 Enter the current date, month, and year. → **OK**
Example: 15 July, 2010
 [1][5] [0][7] [1][0]
- 3 Enter the current hour and minute.
Example: 15:30
 [1][5] [3][0]

4 **OK → [↵]****Note:**

- When you select Arabic or Persian as the display language, enter the current year, month, and date.
- To correct a digit, press [←] or [→] to move the cursor to the digit, then make the correction.
- The date and time may be incorrect after a power failure. In this case, set the date and time again.

One touch eco mode

The [**ECO/R**] button on the handset enables you to activate the eco function with one touch.

By activating eco mode, your unit can reduce the base unit transmission power by up to 90% in standby mode.

You can turn on/off one touch eco mode by just pressing [**ECO/R**]. The default setting is “Normal”.

- When the one touch eco mode is on: “Low” is temporarily displayed and **ECO** is shown on the handset display instead of Ψ .
- When the one touch eco mode is off: “Normal” is temporarily displayed and **ECO** goes off from the handset display.

Note:

- When there is another cordless phone nearby and it is in use, the base unit transmission power may not be reduced.
- Activating one touch eco mode reduces the range of the base unit in standby mode.
- If you set the repeater mode to “On” (page 29):
 - One touch eco mode is cancelled.

Getting Started

- "Eco Setup" is not shown in the display menu (page 23).

Wall mounting

Note:

- Make sure that the wall is strong enough to support the weight of the unit.

■ Base unit

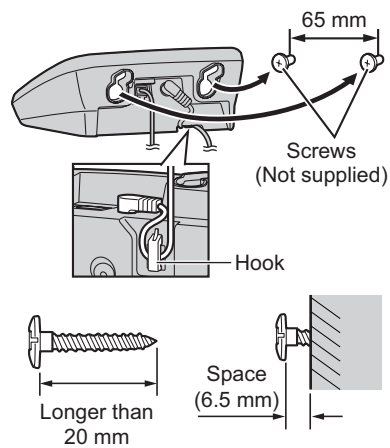

Making/Answering Calls

Making calls

Using the handset

- 1 Lift the handset and dial the phone number.
 - To correct a digit, press **C**.
- 2 Press **[↶]** or **[↷]**.
- 3 When you finish talking, press **[⏏]** or place the handset on the base unit or charger.

Using the speakerphone

- 1 Dial the phone number and press **[☎]**.
 - Speak alternately with the other party.
- 2 When you finish talking, press **[⏏]**.

Note:

- For best performance, use the speakerphone in a quiet environment.
- To switch back to the receiver, press **[↶]**.

Adjusting the receiver or speaker volume

Press **[▲]** or **[▼]** repeatedly while talking.

Making a call using the redial list

The last 10 phone numbers dialed are stored in the redial list (each 24 digits max.).

- 1 **[☎]** or **[▶] (☎)**
- 2 **[▼]/[▲]**: Select the desired phone number.
- 3 **[↶]**

Erasing a number in the redial list

- 1 **[☎]** or **[▶] (☎)**

- 2 **[▼]/[▲]**: Select the desired phone number. → **[X]**
- 3 **[▼]/[▲]**: "Yes" → **OK** → **[⏏]**

Using the base unit

- 1 **[☎]**
- 2 Dial the phone number.
- 3 When the other party answers, speak into the microphone.
 - Speak alternately with the other party.
- 4 When you finish talking, press **[☎]**.

Note:

- For best performance, use the speakerphone in a quiet environment.
- While on a call, you can switch from the base unit to the handset:
 - Press **[↶]** on the handset, then press **[☎]** on the base unit with the privacy mode off (page 25).
 - If the handset is on the base unit, simply lift it.

Adjusting the speaker volume

Press **[▲]** or **[▼]** repeatedly while talking.

Redialling the last number dialed

[☎] → **[☎/P]**

Pause (for PBX/long distance service users)

A pause is sometimes required when making calls using a PBX or long distance service. When storing a calling card access number and/or PIN in the phonebook, a pause is also needed (page 20).

Example: If you need to dial the line access number "0" when making outside calls with a PBX:

Making/Answering Calls

Handset

- 1 [0] → **P**
- 2 Dial the phone number. → [↶]

Base unit

- 1 [☞]
- 2 [0] → [●/P]
- 3 Dial the phone number.

Note for handset and base unit:

- A 3 second pause is inserted each time **P** on the handset or [●/P] on the base unit is pressed. Repeat as needed to create longer pauses.

Answering calls

Using the handset

When a call is being received, the ringer indicator flashes rapidly.

- 1 Lift the handset and press [↶] or [☞] when the unit rings.
 - You can also answer the call by pressing any dial key from [0] to [9], [✖], or [#]. (Any key answer feature)
- 2 When you finish talking, press [✖] or place the handset on the base unit or charger.

Auto talk

You can answer calls simply by lifting the handset off the base unit or charger. You do not need to press [↶]. To turn this feature on, see page 24.

Adjusting the handset ringer volume

Press [▲] or [▼] repeatedly to select the desired volume while the handset is ringing for an incoming call.

Note:

- You can also program the handset ringer volume beforehand (page 24).

Temporary handset ringer off

While the handset is ringing for a call, you can turn the ringer off temporarily by pressing [🔇].

Using the base unit

When a call is being received, the in use indicator flashes rapidly.

- 1 Press [☞] when the unit rings.
- 2 Speak into the microphone.
- 3 When you finish talking, press [☞].

Adjusting the base unit ringer volume

Press [▲] or [▼] repeatedly to select the desired volume.

- To turn the ringer off, press and hold [▼] until the unit beeps.

Note:

- Even when the ringer volume is set to off, the base unit still rings for intercom calls (page 39).

Useful features during a call

Hold

This feature allows you to put an outside call on hold.

Handset

- 1 Press [📞] during an outside call.
- 2 [▼]/[▲]: "Hold" → **OK**
- 3 To release hold, press [↶].
 - The base unit user can take the call by pressing [☞].

Making/Answering Calls

Base unit

- 1 Press [**⏸**] during an outside call.
- 2 To release hold, press [**⏸**].
 - A handset user can take the call by pressing [**⏸**].

Note for handset and base unit:

- If a call is kept on hold for more than 9 minutes, an alarm tone starts to sound. After 1 additional minute on hold, the call is disconnected.
- If another phone is connected to the same line (page 9), you can also take the call by lifting its handset.
- While an outside call is on hold, the in use indicator on the base unit flashes.

Mute

While mute is turned on, you can hear the other party, but the other party cannot hear you.

Handset

- 1 Press [**⏸**] during conversation.
 - [**⏸**] flashes.
- 2 To return to the conversation, press [**⏸**] again.

Base unit

- 1 Press [**⏸**] during conversation.
 - The speakerphone indicator on the base unit flashes.
- 2 To return to the conversation, press [**⏸**] again.

Recall/flash

[**ECO/R**] on the handset or [**R**] on the base unit allows you to use the special features of your host PBX such as transferring an extension call, or accessing optional telephone services.

Note:

- To change the recall/flash time, see page 25.

For call waiting or Call Waiting Caller ID service users

To use call waiting, you must first subscribe to call waiting from your service provider/telephone company. This feature allows you to receive calls while you are already talking on the phone. If you receive a call while on the phone, you will hear a call waiting tone. **If you subscribe to both Caller ID and Call Waiting with Caller ID services**, the 2nd caller's information is displayed after you hear the call waiting tone on the handset.

- 1 Press [**ECO/R**] on the handset or [**R**] on the base unit to answer the 2nd call.
- 2 To switch between calls, press [**ECO/R**] on the handset or [**R**] on the base unit.

Note:

- Please contact your service provider/telephone company for details and availability of this service in your area.

Temporary tone dialling (for rotary/pulse service users)

You can temporarily switch the dialling mode to tone when you need to access touch-tone services (for example, telephone banking services).

- 1 Make a call.
- 2 Press [*****] when prompted to enter your code or PIN, then press the appropriate dial keys.

Note:

- The dialling mode will return to pulse when you hang up.

Making/Answering Calls

Call share

You can join an existing outside call.

Handset

To join the conversation, press **[↶]** when the base unit is on an outside call.

Base unit

To join the conversation, press **[⇐]** when the handset is on an outside call.

Note for handset and base unit:

- To prevent other users from joining your conversations with outside callers, turn the privacy mode on (page 25).

Handset key lock

The handset can be locked so that no calls or settings can be made. Incoming calls can be answered, but all other functions are disabled while key lock is on.

To turn key lock on, press **[🔒]** for about 3 seconds.

- **[🔒]** is displayed.
- To turn key lock off, press **[🔓]** for about 3 seconds.

Note:





- Calls to emergency numbers cannot be made until key lock is turned off.

Handset Phonebook

Handset phonebook







The phonebook allows you to make calls without having to dial manually. You can add 100 names and phone numbers.

Adding entries







- 1  → 
- 2 Enter the party's name (16 characters max.). → **OK**
 - You can change the character entry mode by pressing  (page 41).
- 3 Enter the party's phone number (24 digits max.). → **OK** 2 times
 - To add other entries, repeat from step 2.
- 4 

Finding and calling a phonebook entry



Scrolling through all entries

- 1 
- 2 /: Select the desired entry.
 - You can scroll through the phonebook entry by pressing and holding  or .
- 3 





Searching by first character

- 1 
 - Change the character entry mode if necessary:
 -  → /: Select the character entry mode. → **OK**
- 2 Press the dial key ( to , or ) which contains the character you are searching for (page 41).

- Press the same dial key repeatedly to display the first entry corresponding to each character located on that dial key.
- If there is no entry corresponding to the character you selected, the next entry is displayed.





- 3 /: Scroll through the phonebook if necessary.
- 4 

Editing entries









- 1 Find the desired entry (page 19). → 
- 2 /: "Edit" → **OK**
- 3 Edit the name if necessary (16 characters max.; page 41). → **OK**
- 4 Edit the phone number if necessary (24 digits max.). → **OK** 2 times → 

Erasing entries

Erasing an entry

- 1 Find the desired entry (page 19).
- 2  → /: "Yes" → **OK** → 

Erasing all entries



- 1  → 
- 2 /: "Erase All" → **OK**
- 3 /: "Yes" → **OK**
- 4 /: "Yes" → **OK** → 

Chain dial

This feature allows you to dial phone numbers in the phonebook while you are on a call. This feature can be used, for example, to dial a calling card access number or bank account PIN that you

Handset Phonebook

have stored in the phonebook, without having to dial manually.

- 1** During an outside call, press .
- 2** **[v]/[▲]**: "Phonebook" → **OK**
- 3** **[v]/[▲]**: Select the desired entry.
- 4** Press  to dial the number.

Note:

- When storing a calling card access number and your PIN in the phonebook as one phonebook entry, press **P** to add pauses after the number and PIN as necessary (page 15).
- If you have rotary/pulse service, you need to press **[*]** before pressing  in step 1 to change the dialling mode temporarily to tone. When adding entries to the phonebook, we recommend adding **[*]** to the beginning of phone numbers you wish to chain dial (page 19).

Base Unit Speed Dial**Base unit speed dial**

You can assign one phone number to each of the 10 dial keys ([0] – [9]) on the base unit.

Adding phone numbers to speed dial**Important:**

- Before adding phone numbers, make sure the base unit is not in use.

- 1 [→]
 - The in use indicator flashes.
- 2 Enter the phone number (24 digits max.).
 - If a pause is required for dialling, press [C/P] where needed (page 15).
 - If you enter incorrectly,
 - continue and finish step 4, then start again from step 1.
 - press [■], then start again from step 1. (KX-TG6561)
- 3 [→]
- 4 Press a dial key ([0] – [9]) to assign.
 - A long beep is heard and the in use indicator stops flashing.

Note:

- If a phone number is assigned to a dial key which already contains a phone number, the old number will be erased.
- We recommend you make a note of which phone numbers are stored in which dial keys.

To erase a stored phone number

- 1 [→] 2 times
- 2 Press the desired dial key ([0] – [9]).

Making a call using the speed dial keys

- 1 ■ **KX-TG6551:**
[☎] → [■]
■ **KX-TG6561:**
[☎] → [→]
- 2 Press the desired dial key ([0] – [9]).

Note:

- Speed dial numbers can only be dialled from the base unit.

Programming

Programmable settings

You can customise the unit by programming the following features using the handset.

To access the features, there are 2 methods:





- scrolling through the display menus (page 22)
- using the direct commands (page 24)
- Direct command is the main method used in these operating instructions.

Programming by scrolling through the display menus



- 1 
- 2 Press [▼] or [▲] to select the desired main menu. → **OK**
- 3 Press [▼] or [▲] to select the desired item in sub-menu 1. → **OK**
 - In some cases, you may need to select from sub-menu 2. → **OK**
- 4 Press [▼] or [▲] to select the desired setting. → **OK**
 - This step may vary depending on the feature being programmed.
 - To exit the operation, press [**⏏**].

Note:

- See page 24 for the default settings.

Main menu	Sub-menu 1	Sub-menu 2	Page	
Caller List 	-	-	30	
Answer System  (KX-TG6561)	Play New Msg.	-	34	
	Play All Msg.	-	34	
	Erase All Msg.	-	35	
	Greeting	Start REC		33
		Play Greeting		33
		Default		33
	Settings	Number of Rings		36
		Recording Time		37
		Remote Code		35
		Call Screening		32
Answer On	-	32		
Answer Off	-	32		
Time Settings 	Set Date/Time	-	13	
	Alarm	-	27	
	Time Adjustment	-	-	
Intercom 	-	-	39	

Programming

Main menu	Sub-menu 1	Sub-menu 2	Page
Ringer Setup* ¹  (KX-TG6561)	Ringer Volume	-	-
	Ringtone	-	-
Initial Setup 	Ringer Setup	Ringer Volume	-
		Ringtone	-
	Time Settings	Set Date/Time	13
		Alarm	27
		Time Adjustment	-
	Handset Name	-	27
	Caller Barred* ²	-	28
	Eco Setup	Transmission Power	13
	Display Setup	LCD & Key Backlight	-
		Contrast	-
	Keytones	-	-
	Area Code	-	27
	Auto Talk	-	16
	Line Setup	Dial Mode	13
		Recall/Flash	17
Privacy Mode	-	-	
Base Unit PIN	-	28	
Repeater Mode	-	29	
Register	Register H.set	28	
Language	Display	13	

*1 For KX-TG6551: This menu is displayed before Intercom menu.

*2 KX-TG6561

Programming

Programming using the direct commands

- 1  → [#]
- 2 Enter the desired code.
- 3 Select the desired setting. → **OK**
 - This step may vary depending on the feature being programmed.
 - To exit the operation, press **[*][0]**.

Note:

- In the following table, < > indicates the default settings.

Feature	Code	Setting	Page
Caller List	[2][1][3]	-	30
Set Date/Time	[1][0][1]	-	13
Alarm	[7][2][0]	[1]: Once [2]: Daily [0]: <Off>	27
Time Adjustment ^{*1}	[2][2][6]	[1]: Caller ID [0]: <Manual>	-
Intercom	[2][7][4]	-	39
Ringer Volume ^{*2} (Handset)	[1][6][0]	[1]-[6]: Level 1-6 <6> [0]: Off	-
Ringtone ^{*3, *4} (Handset)	[1][6][1]	<Ringtone 1>	-
Handset Name	[1][0][4]	-	27
Caller Barred ^{*5}	[2][1][7]	-	28
Transmission Power	[7][2][5]	[1]: <Normal> [2]: Low	13
LCD & Key Backlight	[2][7][6]	[1]: <On> [0]: Off	-
Contrast (Display contrast)	[1][4][5]	[1]-[6]: Level 1-6 <3>	-
Keytones ^{*6}	[1][6][5]	[1]: <On> [0]: Off	-
Area Code	[2][5][5]	-	27
Auto Talk ^{*7}	[2][0][0]	[1]: On [0]: <Off>	16
Dial Mode	[1][2][0]	[1]: Pulse [2]: <Tone>	13

Programming

Feature	Code	Setting	Page
Recall/Flash ^{*8}	[1][2][1]	[0]: 900 msec. [1]: 700 msec. [2]: <600 msec.> [3]: 400 msec. [4]: 300 msec. [5]: 250 msec. [*]: 200 msec. [#]: 160 msec. [6]: 110 msec. [7]: 100 msec. [8]: 90 msec. [9]: 80 msec.	17
Privacy Mode ^{*9}	[1][9][4]	[1]: On [0]: <Off>	-
Base Unit PIN	[1][3][2]	<0000>	28
Repeater Mode	[1][3][8]	[1]: On [0]: <Off>	29
Register H.set	[1][3][0]	-	28
Cancel Register	[1][3][1]	-	29
Display (Change language)	[1][1][0]	<English>	13

For the answering system (KX-TG6561)

Feature	Code	Setting	Page
Play New Msg.	[3][2][3]	-	34
Play All Msg.	[3][2][4]	-	34
Erase All Msg.	[3][2][5]	-	35
Start REC (Record greeting)	[3][0][2]	-	33
Play Greeting	[3][0][3]	-	33
Default (Reset to pre-recorded greeting)	[3][0][4]	-	33
Number of Rings	[2][1][1]	<4 Rings>	36
Recording Time	[3][0][5]	<3 Minutes>	37
Remote Code	[3][0][6]	-	35
Call Screening	[3][1][0]	<On>	32
Answer On	[3][2][7]	-	32
Answer Off	[3][2][8]	-	32

*1 This feature allows the unit to automatically adjust the date and time each time caller information including date and time is received.

Programming

To turn this feature on, select **“Caller ID”**. To turn this feature off, select **“Manual”**. (Caller ID subscribers only)

To use this feature, set the date and time first (page 13).

*2 When the ringer volume is turned off, \mathcal{R} is displayed and the handset does not ring for outside calls.

However even when the ringer volume is set to off, the handset still rings for alarm (page 27), intercom calls (page 39), and paging (page 39).

*3 If you select one of the melody ringer tones, the ringer tone continues to play for several seconds even if the caller has already hung up. You may either hear a dial tone or no one on the line when you answer the call.

*4 The preset melodies in this product are used with permission of © 2007 Copyrights Vision Inc.

*5 KX-TG6561

*6 Turn this feature off if you prefer not to hear key tones while you are dialling or pressing any keys, including confirmation tones and error tones.

*7 If you subscribe to a Caller ID service and want to view the caller's information after lifting up the handset to answer a call, turn off this feature.

*8 The recall/flash time depends on your telephone exchange or host PBX. Contact your PBX supplier if necessary.

*9 To prevent other users from joining your conversations with outside callers, turn this feature on.

Programming

Special programming

Alarm

An alarm sounds at the set time for 3 minutes or daily. Alarm can be set for each handset.

Important:

- Set the date and time beforehand (page 13).

- 1 → **[#][7][2][0]**
- 2 **[v]/[▲]**: Select the desired alarm option. → **OK**

<p>"Off" Turns alarm off. Go to step 6.</p>
--

<p>"Once" An alarm sounds once at the set time.</p>
--

<p>"Daily" An alarm sounds daily at the set time. Go to step 4.</p>
--

- 3 Enter the desired date and month. → **OK**
- 4 Set the desired time. → **OK**
- 5 **[v]/[▲]**: Select the desired alarm tone. → **OK**
 - We recommend selecting a different ringer tone from the one used for outside calls.
- 6 **OK** → **[*][0]**
 - When the alarm is set, is displayed.

Note:

- When you select Arabic or Persian as the display language, enter the desired month and date.
- To stop the alarm, press any dial key or place the handset on the base unit or charger.

- When the handset is in use, the alarm will not sound until the handset is in standby mode.

Changing the handset name

Each handset can be given a customised name ("Bob", "Kitchen", etc.). You can also select whether or not the handset name is displayed in standby mode. The default setting is "Off". If you select "On" without entering any handset name, "Handset 1" to "Handset 6" is displayed.

- 1 → **[#][1][0][4]**
- 2 Enter the desired name (max. 10 characters; page 41).
 - If not required, go to step 3.
- 3 **OK**
- 4 **[v]/[▲]**: Select the desired setting. → **OK** 2 times
- 5 **[*][0]**

Storing an area code to be deleted automatically

In some situations, phone numbers stored automatically in the caller list (page 30) will include area codes. If you do not want to dial the area code when making calls from the caller list, you can store the area code which you want the unit to delete automatically.

Example: You have stored the area code "123". If you make a call from the caller list to the phone number "123-456-7890", the unit dials "456-7890".

- 1 → **[#][2][5][5]**
- 2 Enter an area code (5 digits max.). → **OK** → **[*][0]**

Programming

Incoming call barring (Caller ID subscribers only)

Available for:
KX-TG6561

This feature allows the unit to reject calls from specified phone numbers that you do not want to answer such as junk calls. When a call is received, the unit does not ring while the caller is being identified. If the phone number matches an entry in the call barred list, the unit sends out a busy tone to the caller, and then disconnects the call.

Important:

- When the unit receives a call from a number that is stored in the call barred list, the call is logged in the caller list (page 30) with  after the call is disconnected.











Storing unwanted callers

You can store up to 30 phone numbers in the call barred list by using the caller list or by entering the numbers directly.





Important:

- You must store the phone number with an area code in the call barred list.

■ From the caller list:













- 1  (→)
- 2 /: Select the entry to be barred. → 
- 3 /: "Caller Barred" → 
- 4 /: "Yes" →  → 

■ By entering phone numbers:

- 1  → [#][2][1][7] → 
- 2 Enter the phone number (24 digits max.). → 
 - To erase a digit, press .

3

Viewing/editing/erasing bar call numbers

- 1  → [#][2][1][7]
- 2 /: Select the desired entry.
 - To exit, press .
- 3 **To edit a number:**
 -  → Edit the phone number.
 -  → **To erase a number:**
 -  → /: "Yes" → 
 - 



Note:

- When editing, press the desired dial key to add,  to erase.

Changing the base unit PIN (Personal Identification Number)

Important:

- If you change the PIN, please make note of your new PIN. The unit will not reveal the PIN to you. If you forget your PIN, contact an authorised service centre.

- 1  → [#][1][3][2]
- 2 Enter the current 4-digit base unit PIN (default: "0000").
- 3 Enter the new 4-digit base unit PIN. →  → 

Registering a unit

Registering a handset to the base unit

The supplied handset and base unit are pre-registered. If for some reason the handset is not registered to the base unit

Programming

(for example, Ψ is displayed even when the handset is near the base unit), re-register the handset.

- 1 Handset:**
 → **[#][1][3][0]**
- 2 Base unit:**
 Press and hold **[*]** for about 5 seconds, until the registration tone sounds.
 - If all registered handsets start ringing, press the same button to stop. Then repeat this step.
 - The next step must be completed within 90 seconds.
- 3 Handset:**
 Wait until “**Base PIN**” is displayed.
 → Enter the base unit PIN (default: “0000”). → **OK**
 - If you forget your PIN, contact an authorised service centre.
 - When the handset has been registered successfully, Ψ is displayed.

Deregistering a handset

A handset can cancel its own registration that is stored to the base unit. This allows the handset to end its wireless connection with the system.

- 1**  → **[#][1][3][1]**
- 2** **[v]/[▲]**: Select the handset you want to cancel. → **OK**
- 3** **[v]/[▲]**: “**Yes**” → **OK**
 - A confirmation tone sounds.
 - The handset does not beep when cancelling its own registration.
- 4** **[*][0]**

Increasing the range of the base unit

You can increase the signal range of the base unit by using a DECT repeater. Please use only the Panasonic DECT

repeater noted on page 4. Contact your Panasonic dealer for details.

Important:

- Before registering the repeater to this base unit, you must turn the repeater mode on.
- Do not use more than one repeater at a time.

Setting the repeater mode

- 1**  → **[#][1][3][8]**
- 2** **[v]/[▲]**: Select the desired setting.
 → **OK** → **[*][0]**

Note:

- After turning the repeater mode on or off, Ψ is displayed on the handset momentarily. This is normal and the handset can be used once Ψ is displayed.

Caller ID Service

Using Caller ID service

Important:

- This unit is Caller ID compatible. To use Caller ID features, you must subscribe to a Caller ID service. Contact your service provider/telephone company for details.

Caller ID features

When an outside call is being received, the caller's phone number is displayed. Caller information for the last 50 callers is logged in the caller list from the most recent call to the oldest.

- If the unit cannot receive caller information, the following is displayed:
 - “**Out of Area**”: The caller dials from an area which does not provide a Caller ID service.
 - “**Private Caller**”: The caller requests not to send caller information.
- If the unit is connected to a PBX system, caller information may not be properly received. Contact your PBX supplier.

Missed calls

If a call is not answered, the unit treats it as a missed call and **↔** is displayed. This lets you know if you should view the caller list to see who called while you were away.

Even if only one missed call in the caller list is viewed (page 30), **↔** disappears from the display. When you receive another new call, **↔** is displayed again.

Note:

- Even when there are unviewed missed calls, **↔** disappears from the standby display if the following operation is performed by one of the registered handsets:

- Being replaced on the base unit or charger.
- Pressing [**↔**].

Phonebook name display

When caller information is received and it matches a phone number stored in the phonebook, the stored name in the phonebook is displayed and logged in the caller list.

Caller list

Important:

- Make sure the unit's date and time setting is correct (page 13).



Viewing the caller list and calling back

- 1 [**←**] (**↔**)
- 2 Press [**▼**] to search from the most recent call, or press [**▲**] to search from the oldest call.
 - If **▶** is displayed, not all of the information is shown. To see the remaining information, press [**▶**]. To return to the previous screen, press [**←**].
- 3 To call back, press [**↶**]. To exit, press [**↔**].

Note:

- If the entry has already been viewed or answered, “**✓**” is displayed.
- If the call matches an entry in the call barred list, the number is logged with **✖** (page 28). (KX-TG6561)
- If you do not want to dial the area code when making calls from the caller list, you can store the area code which you want the unit to delete automatically (page 27).

Editing a caller's phone number before calling back

- 1 [**←**] (**→**)
- 2 [**▼**]/(**▲**): Select the desired entry.
 - If **▶** is displayed, not all of the information is shown. To see the remaining information, press [**▶**]. To return to the previous screen, press [**←**].
- 3  → Edit the number.
 - Press dial key ([**0**] to [**9**]) to add,  to delete.
- 4 [**↶**]

Erasing selected caller information

- 1 [**←**] (**→**)
- 2 [**▼**]/(**▲**): Select the desired entry.
- 3  → [**▼**]/(**▲**): "Yes" → **OK** → [**↶**]

Erasing all caller information

- 1 [**←**] (**→**)
- 2  → [**▼**]/(**▲**): "Yes" → **OK** → [**↶**]

Storing caller information to the phonebook

- 1 [**←**] (**→**)
- 2 [**▼**]/(**▲**): Select the desired entry. → 
- 3 [**▼**]/(**▲**): "Phonebook" → **OK**
- 4 To store the name, continue from step 2, "Adding entries", page 19.

Answering System

Answering system

Available for:
KX-TG6561

The answering system can answer and record calls for you when you are unavailable to answer the phone. You can also set the unit to play a greeting message but not to record caller messages by selecting “**Greeting Only**” as the recording time setting (page 37).

Important:

- When callers leave messages, the unit records the day and time of each message. Make sure the date and time have been set correctly (page 13).
- Answering system announcements are in English only.

Memory capacity (including your greeting message)

The total recording capacity is about 20 minutes. A maximum of 64 messages can be recorded.

Note:

- If message memory becomes full:
 - “**Messages Full**” is shown on the handset display.
 - The answer on indicator on the base unit flashes rapidly when the answering system is turned on.
- When the message memory becomes full:
 - If you use the pre-recorded greeting message, the unit automatically switches to another pre-recorded greeting message asking callers to call again later.
 - If you recorded your own greeting message, the same message is still

announced to callers even though their messages are not recorded.

Turning the answering system on/off

The answering system is preset to on.

Base unit

Press **[☎]** to turn on/off the answering system.

- When the answering system is turned on, the answer on indicator lights up.

Handset

- 1 **To turn on:**
[☎] → **#[3][2][7]**
To turn off:
[☎] → **#[3][2][8]**
- 2 **[📞]**

Note:

- When the answering system is turned on, **[☎]** is displayed next to the battery icon.

Call screening

While a caller is leaving a message, you can listen to the call through the unit's speakers.

Handset

To adjust the speaker volume, press **[▲]** or **[▼]** repeatedly. You can answer the call by pressing **[📞]**.

The default setting is “On”.

- 1 **[☎]** → **#[3][1][0]**
- 2 **[▼]/[▲]**: Select the desired setting.
→ **OK** → **[📞]**

Answering System

Base unit

To adjust the speaker volume, press [**▲**] or [**▼**] repeatedly. You can answer the call by pressing [**☎**].

To turn off while screening a call, press [**▼**] repeatedly until the sounds goes off.

- If you adjust the speaker volume while listening to messages or while having a conversation, the speaker volume for call screening is turned on again.



Greeting message

When the unit answers a call, a greeting message is played to callers.

You can use either:

- your own greeting message
- a pre-recorded greeting message

Recording your greeting message

- 1  → [#][3][0][2]
- 2 [**▼**]/[**▲**]: “Yes” → **OK**
- 3 After a beep sounds, hold the handset about 20 cm away and speak clearly into the microphone (2 minutes max.).
- 4 Press  to stop recording.
- 5 [**☎**]

Using a pre-recorded greeting message

The unit provides 2 pre-recorded greeting messages:

- If you erase or do not record your own greeting message, the unit plays a pre-recorded greeting asking callers to leave a message.
- If the message recording time (page 37) is set to “Greeting Only”,

callers' messages are not recorded and the unit plays a different pre-recorded greeting message asking callers to call again.

Resetting to a pre-recorded greeting message

If you want to use a pre-recorded greeting message once you record your own greeting message, you need to erase your own greeting message.

- 1  → [#][3][0][4]
- 2 **OK** → [**☎**]

Playing back the greeting message

- 1  → [#][3][0][3]
- 2 [**☎**]

Listening to messages using the base unit

When new messages have been recorded, [**▶**] on the base unit flashes. Press [**▶**].

- If new messages have been recorded, the base unit plays back new messages.
- If there are no new messages, the base unit plays back all messages.

Note:

- When the answer on indicator on the base unit flashes rapidly, the message memory is full (“Memory capacity (including your greeting message)”, page 32).

Answering System

Operating the answering system during playback

Key	Operation
[▲] or [▼]	Adjust the speaker volume
[⏮]	Repeat message*1
[⏭]	Skip message
[■]	Stop playback
[X]	Erase currently playing message

*1 If pressed within the first 5 seconds of a message, the previous message is played.

Erasing all messages

Press [X] 2 times while the unit is not in use.

Listening to messages using the handset

When new messages have been recorded, [M] is displayed on the handset with the total number of new messages.

1 To listen to new messages:

[M] → [#][3][2][3]

To listen to all messages:

[M] → [#][3][2][4]

2 When finished, press [⏻].

Note:

- To switch to the receiver, press [↶].
- If "Messages Full" is shown on the display, [M] and the total number of new messages are not displayed.

Operating the answering system

[M] → [▼]/[▲]: "Answer System"
→ OK

Key	Operation
[▲] or [▼]	Adjust the receiver or speaker volume (during playback)
[1] or [◀]	Repeat message (during playback)*1
[2] or [▶]	Skip message (during playback)
[3]	Enter the "Settings" menu
[4]	Play new messages
[5]	Play all messages
[6]	Play greeting message
[7][6]	Record greeting message
[8]	Turn answering system on
[M]	Pause message*2
[9] or [■]	Stop recording Stop playback
[0]	Turn answering system off
[*][4]*3	Erase currently playing message
[*][5]	Erase all messages
[*][6]	Reset to a pre-recorded greeting message

*1 If pressed within the first 5 seconds of a message, the previous message is played.

*2 To resume playback:

[▼]/[▲]: "Play" → OK

Answering System

*3 You can also erase as follows:

X → **[▼]/[▲]**: "Yes" → **OK**

Calling back (Caller ID subscribers only)

If caller information is received for the call, you can call the caller back while listening to a message.

- 1 Press **[M]** during playback.
- 2 **[▼]/[▲]**: "Call Back" → **OK**

Editing the number before calling back

- 1 Press **[M]** during playback.
- 2 **[▼]/[▲]**: "Edit & Call" → **OK**
- 3 Edit the number. → **[↶]**

Erasing all messages

- 1 **[M]** → **[#][3][2][5]**
- 2 **[▼]/[▲]**: "Yes" → **OK** → **[*][0]**

Remote operation

Using a touch-tone phone, you can call your phone number from outside and access the unit to listen to messages or change answering system settings. The unit's voice guidance prompts you to press certain dial keys to perform different operations.

Remote access code

A 3-digit remote access code must be entered when operating the answering system remotely. This code prevents unauthorised parties from listening to your messages remotely.

Important:

- In order to operate the answering system remotely, you must first set a remote access code.

- 1 **[M]** → **[#][3][0][6]**
- 2 To turn on remote operation, enter the desired 3-digit remote access code.
- 3 **OK** → **[*][0]**

Deactivating remote operation

Press **[*]** in step 2 on "Remote access code", page 35.

- The entered remote access code is deleted.

Using the answering system remotely

- 1 Dial your phone number from a touch-tone phone.
- 2 After the greeting message starts, enter your remote access code.
 - The unit announces the number of new messages.
- 3 Follow the voice guidance prompts as necessary or control the unit using remote commands (page 36).
- 4 When finished, hang up.

Note:

- You can also leave a message just as any outside caller can. After the greeting message starts, press **[*]** to skip the greeting message and record your message after the beep.

Voice guidance

During remote operation, the unit's voice guidance starts and prompts you to press **[1]** to perform a specific operation, or press **[2]** to listen to more available operations.

Answering System

Note:

- If you do not press any dial keys within 10 seconds after a voice guidance prompt, the unit disconnects your call.

Remote commands

You can press dial keys to access certain answering system functions without waiting for the voice guidance to prompt you.

Key	Operation
[1]	Repeat message (during playback)*1
[2]	Skip message (during playback)
[4]	Play new messages
[5]	Play all messages
[6]	Play greeting message
[7]	Record greeting message
[9]	Stop recording Stop playback
[0]	Turn answering system off
[*][4]	Erase currently playing message
[*][5]	Erase all messages
[*][6]	Reset to a pre-recorded greeting message (during greeting message playback)
[*][#]	End remote operation (or hang up)

*1 If pressed within the first 5 seconds of a message, the previous message is played.

Turning on the answering system remotely

If the answering system is off, you can turn it on remotely.

- 1 Dial your phone number from a touch-tone phone.

- 2 Let the phone ring 15 times.
 - A long beep is heard.
- 3 Enter your remote access code within 10 seconds after the long beep.
 - The greeting message is played back.
 - You can either hang up, or enter your remote access code again and begin remote operation (page 35).



Answering system settings

Number of rings before the unit answers a call

You can change the number of times the phone rings “**Number of Rings**” before the unit answers a call. You can select 2 to 7 rings, or “**Auto**”.

The default setting is “**4 Rings**”.

“**Auto**”: The unit’s answering system answers at the end of the 2nd ring when new messages have been recorded, or at the end of the 5th ring when there are no new messages. If you call your phone from outside to listen to new messages (page 35), you know that there are no new messages when the phone rings for the 3rd time. You can then hang up without being charged for the call.

- 1  → [#][2][1][1]
- 2 [v]/[▲]: Select the desired setting.
→  → 

Answering System

For voice mail service subscribers

To receive voice mail and use answering system properly, please note the following:

- To use the voice mail service (page 38) provided by your service provider/ telephone company rather than the unit's answering system, turn off the answering system (page 32).
- To use this unit's answering system rather than the voice mail service provided by your service provider/ telephone company, please contact your service provider/telephone company to deactivate your voice mail service.

If your service provider/telephone company cannot do this:

- Set this unit's **"Number of Rings"** setting so that this unit's answering system answers calls before the voice mail service of your service provider/telephone company does. It is necessary to check the number of rings required to activate the voice mail service provided by your service provider/ telephone company before changing this setting.
- Change the number of rings of the voice mail service so that the answering system can answer the call first. To do so, contact your service provider/telephone company.

Caller's recording time

You can change the maximum message recording time allowed for each caller. The default setting is **"3 Minutes"**.

- 1  → **[#][3][0][5]**
- 2 **[v]/[▲]**: Select the desired setting.
→ **OK** → **[X]**

Selecting "Greeting Only"

You can select **"Greeting Only"** which sets the unit to announce a greeting message to callers but not record messages.

Select **"Greeting Only"** in step 2 on "Caller's recording time", page 37.

Note:

- When you select **"Greeting Only"**:
 - If you do not record your own message, the unit will play the pre-recorded greeting-only message asking callers to call again later.
 - If you use your own message, record the greeting-only message asking callers to call again later (page 33).

Voice Mail Service

Voice mail service

Voice mail is an automatic answering service offered by your service provider/telephone company. After you subscribe to this service, your service provider/telephone company's voice mail system answers calls for you when you are unavailable to answer the phone or when your line is busy. Messages are recorded by your service provider/telephone company, not your telephone. When you have new messages,  is displayed on the handset if message indication service is available. Please contact your service provider/telephone company for details of this service.

Important:

- If  still remains on the display even after you have listened to new messages, turn it off by pressing and holding **[#]** for 2 seconds.
- To use the voice mail service provided by your service provider/telephone company rather than the unit's answering system, turn off the answering system (page 32). For details, see page 37. (KX-TG6561)

Intercom/Locator**Intercom**

Intercom calls can be made between a handset and the base unit.

Note:

- If you receive an outside call while talking on the intercom, you hear 2 tones.
 - To answer the call with the handset, press [**📞**], then press [**📞**].
 - To answer the call with the base unit, press [**📞**] 2 times.
- When paging unit(s), the paged unit(s) beeps for 1 minute.

Making an intercom call**Handset**

- 1 **[📞] → [📞]**
- 2 **OK**
 - To stop paging, press [**📞**].
- 3 When you finish talking, press [**📞**].

Base unit

- 1 **[📞]**
 - To stop paging, press [**📞**].
- 2 When you finish talking, press [**📞**].

Answering an intercom call**Handset**

- 1 Press [**📞**] to answer the page.
- 2 When you finish talking, press [**📞**].

Base unit

- 1 Press [**📞**] to answer the page.
- 2 When you finish talking, press [**📞**].

Handset locator

You can locate a misplaced handset by paging it.

- 1 **Base unit:**
Press [**📞**] and wait for a few seconds.
 - All registered handsets beep for 1 minute.
- 2 To stop paging:
Base unit:
Press [**📞**].
Handset:
Press [**📞**], then press [**📞**].

Transferring calls, conference calls

Outside calls can be transferred or a conference call with an outside party can be made between a handset and the base unit.

Handset

- 1 During an outside call, press [**📞**] to put the call on hold.
 - 2 **OK**
 - 3 Wait for the paged party to answer.
 - If the paged party does not answer, press [**📞**] to return to the outside call.
 - 4 **To complete the transfer:**
Press [**📞**].
 - The outside call is being routed to the destination unit.
- To establish a conference call:**
Press [**📞**].
- To leave the conference, press [**📞**]. The other 2 parties can continue the conversation.

Intercom/Locator

- To put the outside call on hold, press . To resume the conference, press .

Base unit

- 1 During an outside call, press .
- 2 Wait for the paged party to answer.
 - If paged party does not answer, press to return to the outside call.
- 3 **To complete the transfer:**
Press .
 - The outside call is being routed to the handset.**To establish a conference call:**
Press .

Note for handset and base unit:

- If you want to return to the outside call after the paged party answers, press on the handset or press on the base unit.

Answering a transferred call

Handset

Press to answer the page.

Base unit

Press to answer the page.

Useful Information

Character entry

The dial keys are used to enter characters and numbers. Each dial key has multiple characters assigned to it. The characters that can be entered depend on the character entry mode (page 41).

- Press [◀] or [▶] to move the cursor left or right.
- Press dial keys to enter characters and numbers.
- Press **C** to erase the character or number highlighted by the cursor. Press and hold **C** to erase all characters or numbers.
- Press **[*]** (A→a) to switch between uppercase and lowercase.
- If you do not press any dial key within 5 seconds after entering a character, the character is fixed and the cursor moves to the next space.
- When entering another character located on the same dial key, operation will differ depending on the display language you select.

English

- Press [▶] to move the cursor to the next space, then press the appropriate dial key.

Arabic/Persian

- Press [◀] to move the cursor to the next space, then press the appropriate dial key.

Character entry modes

The available character entry modes are Alphabet (ABC), Numeric (0-9), Arabic/Persian (أبج) and Extended (AÄÅ). When in these entry modes except Numeric, you can select which character is entered by pressing a dial key repeatedly.

When the unit displays the character entry screen:

1/A/? → [▼]/[▲]: Select a character entry mode. → **OK**

Note:

- ◻ in the following tables represents a single space.
- When you select Arabic or Persian as the display language, numbers in the character table are displayed in Arabic or Persian.

Alphabet character table (ABC)

0 ◻	1 & ' () * ; - . / 1	2 ABC	3 DEF	4 GHI	5 JKL	6 MNO	7 PQRS	8 TUV	9 WXYZ	#
◻ 0	◻ & ' () * ; - . / 1	A B C	D E F	G H I	J K L	M N O	P Q R	T U V	W X Y	#
		2	3	4	5	6	S 7	8	Z 9	
		a b c	d e f	g h i	j k l	m n o	p q r s	t u v	w x y	
		2	3	4	5	6	7	8	z 9	

Useful Information**Error messages**

If the unit detects a problem, one of the following messages is shown on the display.

Display message	Cause/solution
Base no power or No link. Reconnect AC adaptor.	<ul style="list-style-type: none"> • The handset has lost communication with the base unit. Move closer to the base unit and try again. • Unplug the base unit's AC adaptor to reset the unit. Reconnect the adaptor and try again. • The handset's registration may have been cancelled. Re-register the handset (page 28).
Check Phone Line	<ul style="list-style-type: none"> • The supplied telephone line cord has not been connected yet or not connected properly. Check the connections (page 8).
Error* ¹	<ul style="list-style-type: none"> • Recording was too short. Try again.
Memory Full	<ul style="list-style-type: none"> • The phonebook memory is full. Erase unwanted entries (page 19). • Message memory is full. Erase unwanted messages (page 34).*¹ • The call barred list memory is full. Erase unwanted entries (page 28).*¹
Use rechargeable battery.	<ul style="list-style-type: none"> • A wrong type of battery such as Alkaline or Manganese was inserted. Use only the rechargeable Ni-MH batteries noted on page 4, 6.
You must first subscribe to Caller ID.	<ul style="list-style-type: none"> • You must subscribe to a Caller ID service. Once you receive caller information after subscribing to a Caller ID service, this message will not be displayed.

*1 KX-TG6561

Useful Information

Troubleshooting

If you still have difficulties after following the instructions in this section, disconnect the base unit's AC adaptor and turn off the handset, then reconnect the base unit's AC adaptor and turn on the handset.

General use

Problem	Cause/solution
The handset does not turn on even after installing charged batteries.	<ul style="list-style-type: none"> Place the handset on the base unit or charger to turn on the handset.
The unit does not work.	<ul style="list-style-type: none"> Make sure the batteries are installed correctly (page 8). Fully charge the batteries (page 8). Check the connections (page 8). Unplug the base unit's AC adaptor to reset the unit and turn off the handset. Reconnect the adaptor, turn on the handset and try again. The handset has not been registered to the base unit. Register the handset (page 28).
I cannot hear a dial tone.	<ul style="list-style-type: none"> Make sure that you are using the supplied telephone line cord. Your old telephone line cord may have a different wiring configuration. The base unit's AC adaptor or telephone line cord is not connected. Check the connections. Disconnect the base unit from the telephone line and connect the line to a known working telephone. If the working telephone operates properly, contact our service personnel to have the unit repaired. If the working telephone does not operate properly, contact your service provider/telephone company.
I cannot use the phonebook copy feature.	<ul style="list-style-type: none"> The phonebook copy feature is shared between the handsets. Although the handset displays "Copy All" or "Copy", the phonebook copy feature is not available for this model.

Programmable settings



Problem	Cause/solution
The display is in a language I cannot read.	<ul style="list-style-type: none"> Change the display language (page 13).

Useful Information

Problem	Cause/solution
While programming, the display returns to standby mode.	<ul style="list-style-type: none"> • A call matching an entry in the call barred list is being received.*1 Wait and try again later.
I cannot activate the eco mode.	<ul style="list-style-type: none"> • You cannot set eco mode when you set the repeater mode "On". If required, set the repeater mode to "Off" (page 29).
I cannot register a handset to a base unit.	<ul style="list-style-type: none"> • The maximum number of handsets (6) is already registered to the base unit. Cancel unused handset registrations from the base unit (page 29). • You entered the wrong PIN. If you forget your PIN, contact an authorised service centre.

*1 KX-TG6561

Battery recharge

Problem	Cause/solution
The handset beeps and/or  flashes.	<ul style="list-style-type: none"> • Battery charge is low. Fully charge the batteries (page 8).
I fully charged the batteries, but <ul style="list-style-type: none"> –  still flashes or – the operating time seems to be shorter. 	<ul style="list-style-type: none"> • Clean the battery ends (+, -) and the charge contacts with a dry cloth and charge again. • It is time to replace the batteries (page 8).
The handset display is blank.	<ul style="list-style-type: none"> • The handset is not turned on. Turn the power on (page 12).

Making/answering calls, intercom

Problem	Cause/solution
 is displayed.	<ul style="list-style-type: none"> • The handset is too far from the base unit. Move closer. • The base unit's AC adaptor is not properly connected. Reconnect AC adaptor to the base unit. • The handset is not registered to the base unit. Register it (page 28). • Activating one touch eco mode reduces the range of the base unit in standby mode. If required, turn eco mode off (page 13).

Useful Information

Problem	Cause/solution
Noise is heard, sound cuts in and out.	<ul style="list-style-type: none"> You are using the handset or base unit in an area with high electrical interference. Re-position the base unit and use the handset away from sources of interference. Move closer to the base unit. If you use a DSL/ADSL service, we recommend connecting a DSL/ADSL filter between the base unit and the telephone line jack. Contact your DSL/ADSL provider for details. Unplug the base unit's AC adaptor to reset the unit and turn off the handset. Reconnect the adaptor, turn on the handset and try again.
The handset does not ring.	<ul style="list-style-type: none"> The ringer volume is turned off. Adjust ringer volume (page 24).
The base unit does not ring.	<ul style="list-style-type: none"> The ringer volume is turned off. Adjust ringer volume (page 16).
I cannot make a call.	<ul style="list-style-type: none"> The dialling mode may be set incorrectly. Change the setting (page 13). The handset is too far from the base unit. Move closer and try again. Another unit is in use. Wait and try again later. Answering system is being used by the handset.*1 Wait and try again later. The key lock feature is turned on. Turn it off (page 18).

*1 KX-TG6561

Caller ID

Problem	Cause/solution
Caller information is not displayed.	<ul style="list-style-type: none"> You must subscribe to a Caller ID service. Contact your service provider/telephone company for details. If your unit is connected to any additional telephone equipment, remove and plug the unit directly into the wall jack. If you use a DSL/ADSL service, we recommend connecting a DSL/ADSL filter between the base unit and the telephone line jack. Contact your DSL/ADSL provider for details. Other telephone equipment may be interfering with this unit. Disconnect the other equipment and try again.

Useful Information

Problem	Cause/solution
Caller information is slow to display.	<ul style="list-style-type: none"> • Depending on your service provider/telephone company, the unit may display the caller's information at the 2nd ring or later. • Move closer to the base unit.
Time on the unit has shifted.	<ul style="list-style-type: none"> • Incorrect time information from incoming Caller ID changes the time. Set the time adjustment to "Manual" (off) (page 24).
The name stored in the phonebook is not fully displayed while an outside call is being received.	<ul style="list-style-type: none"> • Edit the phonebook entry name to fit in 1 line of text (page 19).

Answering system (KX-TG6561)

Problem	Cause/solution
The unit does not record new messages.	<ul style="list-style-type: none"> • The answering system is turned off. Turn it on (page 32). • The message memory is full. Erase unwanted messages (page 34). • The recording time is set to "Greeting Only". Change the setting (page 37). • If your own greeting message is not recorded properly, callers are unable to leave a message. Record your own greeting message again (page 33). • If you subscribe to a voice mail service, messages are recorded by your service provider/telephone company, not your telephone. Change the unit's number of rings setting or contact your service provider/telephone company (page 36).
My own greeting message cannot be properly heard.	<ul style="list-style-type: none"> • Record your own greeting message again (page 33).
I cannot operate the answering system.	<ul style="list-style-type: none"> • Someone is using the unit. Wait for the other user to finish. • A caller is leaving a message. Wait for the caller to finish. • The handset is too far from the base unit. Move closer.

Useful Information

Problem	Cause/solution
I cannot operate the answering system remotely.	<ul style="list-style-type: none">• The remote access code is not set. Set the remote access code (page 35).• You are entering the wrong remote access code. If you have forgotten your remote access code, enter the remote access code setting to check your current code (page 35).• Press each key firmly.• The answering system is turned off. Turn it on (page 36).

Liquid damage

Problem	Cause/solution
Liquid or other form of moisture has entered the handset/base unit.	<ul style="list-style-type: none">• Disconnect the AC adaptor and telephone line cord from the base unit. Remove the batteries from the handset and leave to dry for at least 3 days. After the handset/base unit are completely dry, reconnect the AC adaptor and telephone line cord. Insert the batteries and charge fully before use. If the unit does not work properly, contact an authorised service centre.

Caution:

- To avoid permanent damage, do not use a microwave oven to speed up the drying process.

Index

- A** Alarm: 27
 Answering calls
 Base unit: 16
 Handset: 16
 Answering system: 32
 Call screening: 32
 Erasing messages: 34, 36
 Greeting message: 33
 Greeting only: 37
 Listening to messages: 33, 34, 35
 Number of rings: 36
 Recording time: 37
 Remote access code: 35
 Remote operation: 35
 Turning on/off: 32, 34, 36
 Area code: 27
 Auto talk: 16
- B** Battery: 8, 9
- C** Caller ID service: 30
 Caller list: 30
 Caller list edit: 31
 Call share: 18
 Call waiting: 17
 Call Waiting Caller ID: 17
 Chain dial: 19
 Character entry: 41
 Conference calls: 39
 Control type: 10
- D** Date and time: 13
 Dialling mode: 13
 Direct command: 24
 Display
 Contrast: 24
 Language: 13
- E** Eco mode: 13
 Error messages: 43
- H** Handset
 Deregistration: 29
 Locator: 39
 Name: 27
 Registration: 28
 Hold: 16
- I** Incoming call barring: 28
 Intercom: 39
- K** Key lock: 18
 Keytones: 24
- M** Making calls
 Base unit: 15
 Handset: 15
 Missed calls: 30
 Mute: 17
- P** Pause: 15
 Phonebook: 19
 PIN: 28
 Power failure: 9
 Power on/off: 12
 Privacy mode: 25
- R** Recall/flash: 17
 Redialling: 15
 Repeater: 29
 Ringer tone: 24
- S** Speakerphone: 15
 Speed dial: 21
- T** Temporary tone dialling: 17
 Time adjustment: 24
 Transferring calls: 39
 Troubleshooting: 44
- V** Voice mail: 38
 Volume
 Receiver: 15
 Ringer (Base unit): 16
 Ringer (Handset): 16, 24
 Speaker: 15
- W** Wall mounting: 14

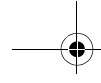

Notes

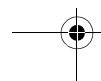
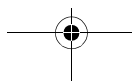
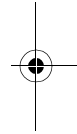
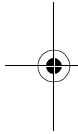

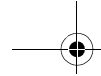

Notes

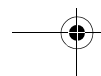
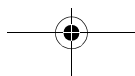
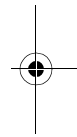
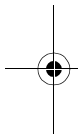

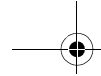

For your future reference

We recommend keeping a record of the following information to assist with any repair under warranty.

Serial No.

Date of purchase

(found on the bottom of the base unit)

Name and address of dealer

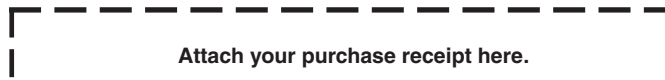

Attach your purchase receipt here.

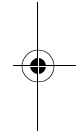
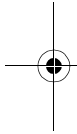

Panasonic System Networks Co., Ltd.
1-62, 4-chome, Minoshima, Hakata-ku, Fukuoka 812-8531, Japan

Copyright:

This material is copyrighted by Panasonic System Networks Co., Ltd., and may be reproduced for internal use only. All other reproduction, in whole or in part, is prohibited without the written consent of Panasonic System Networks Co., Ltd.

© Panasonic System Networks Co., Ltd. 2010



TG6551 BX

PNQX2597ZA CC0810DJ0 (A)

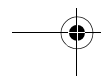
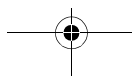

Free Manuals Download Website

<http://myh66.com>

<http://usermanuals.us>

<http://www.somanuals.com>

<http://www.4manuals.cc>

<http://www.manual-lib.com>

<http://www.404manual.com>

<http://www.luxmanual.com>

<http://aubethermostatmanual.com>

Golf course search by state

<http://golfingnear.com>

Email search by domain

<http://emailbydomain.com>

Auto manuals search

<http://auto.somanuals.com>

TV manuals search

<http://tv.somanuals.com>