

Panasonic®

Operating Instructions

Blu-ray Disc Player

Model No. **DMP-BD55**
DMP-BD35

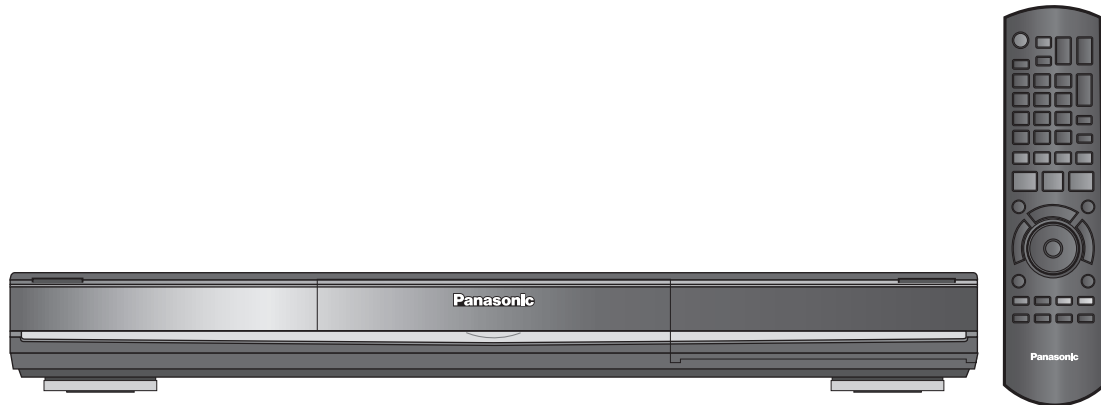

The illustration shows the image of DMP-BD55.

Dear customer

Thank you for purchasing this product.

For optimum performance and safety, please read these instructions carefully.

Before connecting, operating or adjusting this product, please read the instructions completely. Please keep this manual for future reference.



Region management information

BD-Video

This unit plays BD-Video marked with labels containing the region code A.

Example:



DVD-Video

This unit plays DVD-Video marked with labels containing the region number "1" or "ALL".

Example:



As an ENERGY STAR® Partner,*
Panasonic has determined that
this product meets the ENERGY STAR®
guidelines for energy efficiency.

* For Canada only: The word "Participant" is used in place of the word "Partner".

If you have any questions contact

U.S.A.: 1-800-211-PANA(7262)
Canada: 1-800-561-5505

U.S.A.: The warranty can be found on page 42.
Canada: The warranty can be found on page 43.

La referencia rápida en español se puede encontrar en la página 45.

IMPORTANT SAFETY INSTRUCTIONS

Read these operating instructions carefully before using the unit. Follow the safety instructions on the unit and the applicable safety instructions listed below. Keep these operating instructions handy for future reference.

- 1) Read these instructions.
- 2) Keep these instructions.
- 3) Heed all warnings.
- 4) Follow all instructions.
- 5) Do not use this apparatus near water.
- 6) Clean only with dry cloth.
- 7) Do not block any ventilation openings. Install in accordance with the manufacturer's instructions.
- 8) Do not install near any heat sources such as radiators, heat registers, stoves, or other apparatus (including amplifiers) that produce heat.
- 9) Do not defeat the safety purpose of the polarized or grounding-type plug. A polarized plug has two blades with one wider than the other. A grounding-type plug has two blades and a third grounding prong. The wide blade or the third prong are provided for your safety. If the provided plug does not fit into your outlet, consult an electrician for replacement of the obsolete outlet.
- 10) Protect the power cord from being walked on or pinched particularly at plugs, convenience receptacles, and the point where they exit from the apparatus.
- 11) Only use attachments/accessories specified by the manufacturer.
- 12) Use only with the cart, stand, tripod, bracket, or table specified by the manufacturer, or sold with the apparatus. When a cart is used, use caution when moving the cart/apparatus combination to avoid injury from tip-over.
- 13) Unplug this apparatus during lightning storms or when unused for long periods of time.
- 14) Refer all servicing to qualified service personnel. Servicing is required when the apparatus has been damaged in any way, such as power-supply cord or plug is damaged, liquid has been spilled or objects have fallen into the apparatus, the apparatus has been exposed to rain or moisture, does not operate normally, or has been dropped.



WARNING:

TO REDUCE THE RISK OF FIRE, ELECTRIC SHOCK OR PRODUCT DAMAGE,

- DO NOT EXPOSE THIS APPARATUS TO RAIN, MOISTURE, DRIPPING OR SPLASHING AND THAT NO OBJECTS FILLED WITH LIQUIDS, SUCH AS VASES, SHALL BE PLACED ON THE APPARATUS.
- USE ONLY THE RECOMMENDED ACCESSORIES.
- DO NOT REMOVE THE COVER (OR BACK); THERE ARE NO USER SERVICEABLE PARTS INSIDE. REFER SERVICING TO QUALIFIED SERVICE PERSONNEL.

CAUTION!

DO NOT INSTALL OR PLACE THIS UNIT IN A BOOKCASE, BUILT-IN CABINET OR IN ANOTHER CONFINED SPACE. ENSURE THE UNIT IS WELL VENTILATED. TO PREVENT RISK OF ELECTRIC SHOCK OR FIRE HAZARD DUE TO OVERHEATING, ENSURE THAT CURTAINS AND ANY OTHER MATERIALS DO NOT OBSTRUCT THE VENTILATION VENTS.

CAUTION!

THIS PRODUCT UTILIZES A LASER. USE OF CONTROLS OR ADJUSTMENTS OR PERFORMANCE OF PROCEDURES OTHER THAN THOSE SPECIFIED HEREIN MAY RESULT IN HAZARDOUS RADIATION EXPOSURE. DO NOT OPEN COVERS AND DO NOT REPAIR YOURSELF. REFER SERVICING TO QUALIFIED PERSONNEL.

CAUTION

Danger of explosion if battery is incorrectly replaced. Replace only with the same or equivalent type recommended by the manufacturer. Dispose of used batteries according to the manufacturer's instructions.

The socket outlet shall be installed near the equipment and easily accessible. The mains plug of the power supply cord shall remain readily operable. To completely disconnect this apparatus from the AC Mains, disconnect the power supply cord plug from AC receptacle.

2

CAUTION

**RISK OF ELECTRIC SHOCK
DO NOT OPEN**

CAUTION: TO REDUCE THE RISK OF ELECTRIC SHOCK, DO NOT REMOVE SCREWS. NO USER-SERVICEABLE PARTS INSIDE. REFER SERVICING TO QUALIFIED SERVICE PERSONNEL.



The lightning flash with arrowhead symbol, within an equilateral triangle, is intended to alert the user to the presence of uninsulated "dangerous voltage" within the product's enclosure that may be of sufficient magnitude to constitute a risk of electric shock to persons.



The exclamation point within an equilateral triangle is intended to alert the user to the presence of important operating and maintenance (servicing) instructions in the literature accompanying the appliance.

THE FOLLOWING APPLIES ONLY IN THE U.S.A.

FCC Note:

This equipment has been tested and found to comply with the limits for a Class B digital device, pursuant to Part 15 of the FCC Rules. These limits are designed to provide reasonable protection against harmful interference in a residential installation. This equipment generates, uses, and can radiate radio frequency energy and, if not installed and used in accordance with the instructions, may cause harmful interference to radio communications. However, there is no guarantee that interference will not occur in a particular installation. If this equipment does cause harmful interference to radio or television reception, which can be determined by turning the equipment off and on, the user is encouraged to try to correct the interference by one or more of the following measures:

- Reorient or relocate the receiving antenna.
- Increase the separation between the equipment and receiver.
- Connect the equipment into an outlet on a circuit different from that to which the receiver is connected.
- Consult the dealer or an experienced radio/TV technician for help.

FCC Caution: To assure continued compliance, follow the attached installation instructions and use only shielded interface cables when connecting to peripheral devices.

Any changes or modifications not expressly approved by the party responsible for compliance could void the user's authority to operate this equipment.

This device complies with Part 15 of the FCC Rules. Operation is subject to the following two conditions: (1) This device may not cause harmful interference, and (2) this device must accept any interference received, including interference that may cause undesired operation.

Responsible Party:
Panasonic Corporation of North America
One Panasonic Way
Secaucus, NJ 07094

Support Contact:
Panasonic Consumer Electronics Company
Telephone No.: 1-800-211-PANA (7262)

(RQT9243)

| | |
|---|--|
| DANGER – VISIBLE AND INVISIBLE LASER RADIATION WHEN OPEN. AVOID DIRECT EXPOSURE TO BEAM. FDA 21 CFR/Class IIIb | |
| CAUTION – CLASS 3B VISIBLE AND INVISIBLE LASER RADIATION WHEN OPEN. AVOID EXPOSURE TO THE BEAM. IEC60825-1 +A2/Class 3B | |
| ATTENTION – RAYONNEMENT LASER VISIBLE ET INVISIBLE. CLASSE 3B EN CAS D'OUVERTURE. EVITER UNE EXPOSITION AU FAISCEAU. | |
| FORSIGTIG – SYNLIG OG USYNLIG LASERSTRÅLING KLASSE 3B. NÅR LÅGET ER ÅBENT, UNDGÅ AT SE LIGE PÅ MED OPTISKE INSTRUMENTER. | |
| VARO – AVATTAESSA OLET ALTTIINA LUOKAN 3B NÄKYVÄÄ JA NÄKYMÄTÖNTÄ LASERSÄTEILYÄ. VÄRÖ AALTISTUMISTA SÄTEELLE. | |
| WARNING – KLASS 3B SYNLIG OCH OSYNLIG LASERSTRÅLNING NÄR DENNA DEL ÄR ÖPPNAD. UNDVIK EXPOSITIONER FÖR STRÅLEN. | |
| VORSICHT – SICHTBARE UND UNSICHTBARE LASERSTRAHLUNG KLASSE 3B. WENN ABDECKUNG GEÖFFNET, NICHT DEM STRAHL AUSSETZEN. | |
| 注意 – 打开时有可见及不可见激光辐射。避免光束照射。 | |
| 注意 – ここを開くと可視及び不可視レーザー光が出ます。ビームを見たり、触れたりしないでください。 VOL1J70 | |

(Inside of product)

(RQT9350)

| | |
|--|--|
| CAUTION – VISIBLE AND INVISIBLE LASER RADIATION WHEN OPEN. DO NOT STARE INTO BEAM. FDA 21 CFR/Class II (IIa) | |
| CAUTION – CLASS 1M VISIBLE AND INVISIBLE LASER RADIATION WHEN OPEN. DO NOT VIEW DIRECTLY WITH OPTICAL INSTRUMENTS. IEC60825-1 +A2/CLASS 1M | |
| ATTENTION – RAYONNEMENT LASER VISIBLE ET INVISIBLE. CLASSE 1M EN CAS D'OUVERTURE. NE PAS REGARDER DIRECTEMENT À L'ŒIL DES INSTRUMENTS OPTIQUES. | |
| FORSIGTIG – SYNLIG OG USYNLIG LASERSTRÅLING KLASSE 1M. NÅR LÅGET ER ÅBENT, UNDGÅ AT SE LIGE PÅ MED OPTISKE INSTRUMENTER. | |
| VARO – AVATTAESSA OLET ALTTIINA LUOKAN 1M NÄKYVÄÄ JA NÄKYMÄTÖNTÄ LASERSÄTEILYÄ. ÄLÄ KATSO OPTISELLA LAITTEELLA SUORAAN SÄTEESEEN. | |
| WARNING – KLASS 1M SYNLIG OCH OSYNLIG LASERSTRÅLNING NÄR DENNA DEL ÄR ÖPPNAD. BETRÄKTA EJ STRÅLEN DIREKT GENOM OPTISKT INSTRUMENT. | |
| VORSICHT – SICHTBARE UND UNSICHTBARE LASERSTRAHLUNG KLASSE 1M. WENN ABDECKUNG GEÖFFNET, NICHT DIREKT MIT OPTISCHEN INSTRUMENTEN BETRACHTEN. | |
| 注意 – 打开时有可见及不可见激光辐射。避免光束照射。 | |
| 注意 – ここを開くと可視及び不可視レーザー光が出ます。ビームを見たり、触れたりしないでください。 VOL1V70 | |

(Inside of product)

Disc and card handling

Clean discs

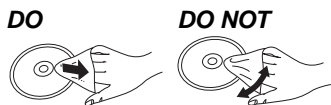

Wipe with a damp cloth and then wipe dry.

Disc and card handling precautions

- Handle discs by the edges to avoid inadvertent scratches or fingerprints on the disc.
- Do not attach labels or stickers to discs (This may cause disc warping, rendering it unusable).
- Do not write on the label side with a ball-point pen or other writing instrument.
- Do not use record cleaning sprays, benzene, thinner, static electricity prevention liquids or any other solvent.
- Do not use scratch-proof protectors or covers.
- Clean any dust, water, or foreign matter from the terminals on the rear side of the card.
- Do not use the following discs:
 - Discs with exposed adhesive from removed stickers or labels (rented discs etc).
 - Discs that are badly warped or cracked.
 - Irregularly shaped discs, such as heart shapes.

Maintenance

Clean this unit with a soft, dry cloth

- Never use alcohol, paint thinner or benzene to clean this unit.
- Before using chemically treated cloth, carefully read the instructions that came with the cloth.

Observe the following points to ensure continued listening and viewing pleasure.

Dust and dirt may adhere to the unit's lens over time, making it impossible to play discs.

Use the lens cleaner (not included) about once every year, depending on frequency of use and the operating environment. Carefully read the lens cleaner's instructions before use.

Lens cleaner: RP-CL720PP

- This lens cleaner is sold as specific for DIGA, but can be used without problem on this unit as well.

To dispose or transfer this unit

This unit may record information of your operating procedures. If you discard this unit either by disposal or transfer, then follow the procedures to return all the settings to the factory presets to delete the recorded information. (⇒ 38, "To return to the factory preset")

- When BD-Video is played back, the operation history may be recorded in the memory of this unit. The recorded contents differ depending on the disc.

Table of contents

Getting started

| | |
|--|----|
| IMPORTANT SAFETY INSTRUCTIONS | 2 |
| Unit and media care | 3 |
| Accessory information..... | 5 |
| Disc and card information | 6 |
| Audio and video information..... | 8 |
| Connections..... | 10 |
| Broadband network connection..... | 14 |
| Firmware updates..... | 14 |
| Remote control and unit reference guide..... | 15 |
| Setting | 16 |
| Network settings..... | 17 |

Playback

| | |
|--|----|
| Basic play (Playing video contents) | 19 |
| Enjoying the advanced functions on BD-Video discs | 21 |
| Chapter playback | 22 |
| Playing still pictures | 22 |
| Playing DivX videos | 24 |
| Playing music | 25 |
| Linked operations with the TV (VIERA Link™ “HDAVI Control™”) | 26 |

Settings

| | |
|--|----|
| Changing settings with the on-screen menu | 28 |
| Changing the unit’s settings | 30 |

Reference

| | |
|---|------------|
| About MP3/JPEG/DivX files | 35 |
| Messages | 36 |
| Troubleshooting guide | 38 |
| Specifications | 41 |
| Limited Warranty (ONLY FOR U.S.A.) | 42 |
| Limited Warranty (ONLY FOR CANADA) | 43 |
| Product Service | 44 |
| Licenses | 44 |
| Referencia rápida en español (Spanish Quick Reference) | 45 |
| Glossary | 46 |
| Index | Back cover |

About descriptions in these operating instructions

- These operating instructions are applicable to models DMP-BD55 and DMP-BD35. Unless otherwise indicated, illustrations in these operating instructions are of DMP-BD55.
[BD55] : indicates features applicable to DMP-BD55 only.
[BD35] : indicates features applicable to DMP-BD35 only.

Accessory information



Please check and identify the supplied accessories. Use numbers indicated in parentheses when asking for replacement parts.

(Product numbers correct as of August 2008. These may be subject to change.)

Only for U.S.A.: To order accessories, refer to "Accessory Purchases" on page 42.

Only for Canada: To order accessories, call the dealer from whom you have made your purchase.



1 Remote control
(N2QAYB000184)

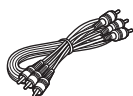

1 Audio/Video cable
(K2KA6BA00004)

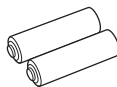

2 Batteries
for remote control

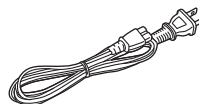

1 AC power supply cord
(K2CB2CB00022)
• For use with this unit only.
Do not use it with other equipment.
Also, do not use cords from other equipment with this unit.

(ONLY FOR U.S.A.)

Product Registration Card

Please complete and return the included product registration card, or register via the Internet at:

<http://www.prodreg.com/panasonic/>

BD55:

BD35: (ONLY FOR CANADA)

The enclosed Canadian French label sheet corresponds to the English display on the front and back side of the unit.

Using the remote control

Batteries

Insert so the poles (+ and -) match those in the remote control.

When closing the lid, insert it from the - (minus) side.

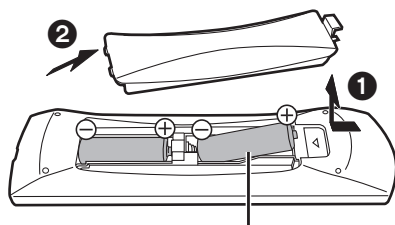

R6/LR6, AA

- Do not use rechargeable type batteries.
- Do not mix old and new batteries.
- Do not use different types at the same time.
- Do not heat or expose to flame.
- Do not leave the battery(ies) in an automobile exposed to direct sunlight for a long period of time with doors and windows closed.
- Do not take apart or short circuit.
- Do not attempt to recharge alkaline or manganese batteries.
- Do not use batteries if the covering has been peeled off.

Mishandling of batteries can cause electrolyte leakage which can damage items the fluid contacts and may cause a fire.

Remove batteries if the remote control is not going to be used for a long period of time. Store in a cool, dark place.

Use

Remote control signal sensor

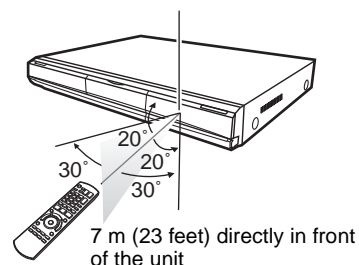

If you cannot operate the unit or other equipment using the remote control after changing the batteries, please re-enter the codes (⇒ 16, 33).





CAUTION

Do not place objects in front of the unit. The disc tray may collide with objects when it is opened, and this may cause injury.

Disc and card information

Commercially sold discs





This chart shows the different type of retail/commercial discs you can use, and also includes the industry-standard logos that should appear on the discs and/or packaging.

| Type of media | Logo | Features | Indicated as |
|------------------|---|--|--------------|
| BD-Video |  | <p>This format supports High Definition video and audio content including:</p> <ul style="list-style-type: none"> •BD-Live (BD-ROM version 2 Profile 2). This format provides interactive features when this player is connected to the Internet via a broadband connection. <p style="text-align: center;"></p> <ul style="list-style-type: none"> •BONUSVIEW allows virtual packages or picture-in-picture functions to be viewed. <p style="text-align: center;">BONUSVIEW™</p> | BD-V |
| DVD-Video |  | This format supports high quality video and audio playback. | DVD-V |
| CD |  | <p>Compact Discs (CD's) that contain audio and music</p> <ul style="list-style-type: none"> •Operation and sound quality of CDs that do not conform to CD-DA specifications (copy control CDs, etc.) cannot be guaranteed. •The digital audio content side of a DualDisc does not meet the technical specifications of the Compact Disc Digital Audio (CD-DA) format so play may not be possible. | CD |

User recorded media

This chart shows the different type of discs recorded with other devices that you can use.

Finalized This mark means you must finalize the disc with the DVD recorder, etc. before playback. For details about finalizing, refer to the operating instructions for your equipment.

| Type of media | Logo | Formats | Indicated as |
|---|---|---|--|
| BD-RE |  | <ul style="list-style-type: none"> •Version 3 of the BD-RE Recording Format •JPEG format | BD-V JPEG |
| BD-R |  | <ul style="list-style-type: none"> •Version 2 of the BD-R Recording Format | BD-V |
| DVD-RAM |  | <ul style="list-style-type: none"> •Version 1.1 of the DVD Video Recording Format •JPEG format •AVCHD format | DVD-VR JPEG AVCHD |
| DVD-R/RW Finalized |  | <ul style="list-style-type: none"> •DVD-Video Format •Version 1.1 of the DVD Video Recording Format •AVCHD format •BD55: DivX format (DVD-RW is not supported) | DVD-V DVD-VR AVCHD DivX |
| DVD-R DL Finalized |  | <ul style="list-style-type: none"> •DVD-Video Format •Version 1.2 of the DVD Video Recording Format •AVCHD format •BD55: DivX format | DVD-V DVD-VR AVCHD DivX |
| +R/+RW/+R DL Finalized | — | <ul style="list-style-type: none"> •+VR (+R/+RW Video Recording) Format •AVCHD format | DVD-V AVCHD |
| CD-R/RW Finalized | — | <ul style="list-style-type: none"> •CD-DA format •MP3 format •JPEG format •BD55: DivX format | CD MP3 JPEG DivX |

- It may not be possible to play the above discs in some cases due to the type of discs, the condition of the recording, the recording method and how the files were created.
- When a disc recorded in the AVCHD format is being played, the video may be paused for a few seconds at portions spliced, due to deletion or editing.

SD cards

This chart shows the different type of cards recorded with other devices that you can use.

| Type of media | Logo | Formats | Indicated as |
|--|------|---|---|
| SD Memory Card* (from 8 MB to 2 GB) SDHC Memory Card (from 4 GB to 32 GB) | — | <ul style="list-style-type: none"> • JPEG format • AVCHD format | <div style="border: 1px solid black; padding: 2px; display: inline-block;">JPEG</div> <div style="border: 1px solid black; padding: 2px; display: inline-block;">AVCHD</div> |

* Includes miniSD Card and microSD Card

- Please confirm the latest information on the following website.
<http://panasonic.co.jp/pavc/global/cs>
(This site is in English only.)
- When using cards from 4GB to 32GB, only SD cards using the SDHC logo can be used.
- This unit is compatible with SD Memory Cards that meet SD Card Specifications FAT12 and FAT16 formats, as well as SDHC Memory Cards in FAT32 format.
- The card types mentioned above will be referred to as "SD card" in these operating instructions.
- MiniSD Cards and microSD Cards can be used, but must be used with an adaptor card. These are usually supplied with such cards, or otherwise customer provided.
- **BD-V**: To play the virtual package (⇒ 21), it is recommended that you use a card that supports SD Speed Class Rating Class 2 and has 1 GB or more free space.
- Useable memory is slightly less than the card capacity.
- If the SD card you are attempting to use was formatted on a PC, it is possible that the card may not work properly.
- We recommend using a Panasonic SD card.
- Keep the Memory Card out of reach of children to prevent swallowing.
- When a card recorded in the AVCHD format is being played, the video may momentarily pause, especially where one recording ends and the next one begins. This is normal and does not indicate a problem.
- To protect the card's contents, move the record prevention tab (on the SD card) to "LOCK".



Discs that cannot be played in this unit

- BD-RE discs (with cartridge)
- 2.6 GB and 5.2 GB DVD-RAM
- DVD-RAM that cannot be removed from cartridge
- 3.95 GB and 4.7 GB DVD-R (Authoring)
- Version 1.0 DVD-RW
- +R 8cm (3"), DVD-ROM, CD-ROM, CDV, SACD, Photo CD, MV-Disc and PD
- DVD-Audio
- Video CD and SVCD
- WMA discs
- **BD35**: DivX discs
- PAL Discs
- HD DVD
- BD-Video discs recorded at a rate of 50 fields/sec
- Any other disc that is not specifically supported

Structure of folders that can be played in this unit

You can play files on this unit by structure of folders as shown below. However depending on the method of writing data (writing software), play may not be in the order you numbered the folders.

- Folder structure created on a DVD-RAM, BD-RE or an SD card is not displayed.

Folder which can be displayed with this unit

***: Numbers

XXX: Letters

*1 ***: from 001 to 999

*2 ***: from 100 to 999

XXX: up to 5 figures

*3 ****: from 0001 to 9999

Structure of MP3 folders in CD-R/CD-RW

Prefix the file names with 3-digit numbers in the order you want to play them.

Structure of DivX folders in CD-R/CD-RW/DVD-R/DVD-RW/DVD-R DL **BD55**

Files inside a folder are displayed in the order they were updated or taken.

Structures of still picture (JPEG) folders

in CD-R/CD-RW

Files inside a folder are displayed in the order they were updated or taken.

in BD-RE/DVD-RAM

- When the highest level folders are "DCIM" folders, they are displayed as a priority in the "Select Folder" screen.

in SD card

- When the highest level folders are "DCIM" folders, they are displayed as a priority in the "Select Folder" screen.

| CD-R/CD-RW (MP3) | DivX BD55 | CD-R/CD-RW (JPEG) | BD-RE/DVD-RAM (JPEG) | SD Card (JPEG) |
|---|---|---|---|---|
| <p>Root e.g.,</p> <ul style="list-style-type: none"> 001XXXX.mp3 002XXXX.mp3 <p>Folder A</p> <ul style="list-style-type: none"> 003XXXX.mp3 004XXXX.mp3 005XXXX.mp3 <p>Folder B</p> <ul style="list-style-type: none"> 006XXXX.mp3 007XXXX.mp3 008XXXX.mp3 009XXXX.mp3 <p>Folder C</p> <ul style="list-style-type: none"> 010XXXX.mp3 011XXXX.mp3 012XXXX.mp3 | <p>Root e.g.,</p> <ul style="list-style-type: none"> P0000001.divx P0000002.divx <p>Folder A</p> <ul style="list-style-type: none"> P0000003.divx P0000004.divx P0000005.divx <p>Folder B</p> <ul style="list-style-type: none"> P0000006.divx P0000007.divx P0000008.divx P0000009.divx <p>Folder C</p> <ul style="list-style-type: none"> P0000010.divx P0000011.divx P0000012.divx | <p>Root e.g.,</p> <ul style="list-style-type: none"> P0000001.jpg P0000002.jpg <p>Folder A</p> <ul style="list-style-type: none"> P0000003.jpg P0000004.jpg P0000005.jpg <p>Folder B</p> <ul style="list-style-type: none"> P0000006.jpg P0000007.jpg P0000008.jpg P0000009.jpg <p>Folder C</p> <ul style="list-style-type: none"> P0000010.jpg P0000011.jpg P0000012.jpg | <p>Root e.g.,</p> <ul style="list-style-type: none"> P0000001.jpg P0000002.jpg <p>JPEG</p> <ul style="list-style-type: none"> DCIM***^{*1} ***XXXXX^{*2} XXXX*****.JPG^{*3} <p>DCIM</p> <ul style="list-style-type: none"> ***XXXXX^{*2} <p>Folder A</p> <ul style="list-style-type: none"> XXXX*****.JPG^{*3} | <p>Root e.g.,</p> <ul style="list-style-type: none"> P0000001.jpg P0000002.jpg <p>DCIM</p> <ul style="list-style-type: none"> ***XXXXX^{*2} XXXX*****.JPG^{*3} <p>Folder A</p> <ul style="list-style-type: none"> P0000003.jpg P0000004.jpg |

Audio and video information

About audio from audio output terminals

Before connecting, read the table below, and confirm the desired audio type and necessary settings ("BD-Video Secondary Audio", "Dolby D/Dolby D +/Dolby TrueHD" or "DTS/DTS-HD"). (⇒ 9)

- The number of channels listed is the maximum possible number of output channels.

HDMI AV OUT/DIGITAL AUDIO OUT (Coaxial **BD55**/Optical)

| Terminal | HDMI AV OUT | | | | DIGITAL AUDIO OUT | |
|--|--|------------------------------------|---------------------------------------|-----------|--|-----------------------|
| | "Bitstream" ^{*1} | | "PCM" ^{*3} | | "Bitstream" | "PCM" |
| | "On" ^{*2} | "Off" | "On" | "Off" | "On"/"Off" | "On"/"Off" |
| Dolby Digital/ Dolby Digital EX ^{*5} | Dolby Digital/ Dolby Digital EX ^{*6} | Dolby Digital/ Dolby Digital EX | 5.1ch PCM | | Dolby Digital/ Dolby Digital EX ^{*6} | Down-mixed 2ch PCM |
| Dolby Digital Plus | Dolby Digital | Dolby Digital Plus | 5.1ch PCM ^{*2} | 7.1ch PCM | Dolby Digital | |
| Dolby TrueHD | | Dolby TrueHD | | | | |
| DTS Digital Surround/ DTS-ES ^{*5} | DTS Digital Surround/ DTS-ES ^{*6} | DTS Digital Surround/ DTS-ES | DVD-V: 5.1ch PCM | | DTS Digital Surround/ DTS-ES ^{*6} | |
| | | | BD-V: 7.1ch PCM ^{*4} | | | |
| DTS-HD High Resolution Audio | DTS Digital Surround | DTS-HD High Resolution Audio | 7.1ch PCM ^{*4} | | DTS Digital Surround | |
| DTS-HD Master Audio | | DTS-HD Master Audio | | | | |
| 7.1ch LPCM | Down-mixed 5.1ch PCM | 7.1ch PCM | Down-mixed 5.1ch PCM ^{*2} | 7.1ch PCM | Down-mixed 2ch PCM | |

AUDIO OUT (Analog)

| Terminal | 7.1ch AUDIO OUT BD55 | | 5.1ch AUDIO OUT BD55 | 2ch AUDIO OUT |
|------------------------------------|-----------------------------------|-------|-----------------------------|---------------|
| | "On" | "Off" | "On"/"Off" | "On"/"Off" |
| Dolby Digital/ Dolby Digital EX | 5.1ch | | 5.1ch | 2ch |
| Dolby Digital Plus | 5.1ch ^{*2} | 7.1ch | | |
| Dolby TrueHD | | | | |
| DTS Digital Surround/ DTS-ES | DVD-V: 5.1ch | | | |
| | BD-V: 7.1ch ^{*4} | | | |
| DTS-HD High Resolution Audio | 7.1ch ^{*4} | | | |
| DTS-HD Master Audio | | | | |
| 7.1ch LPCM | Down-mixed 5.1ch ^{*2} | 7.1ch | | |

- Also, depending on the specifications or the settings of the amplifier/receiver, the results of the output may vary.

*1 When the connected equipment is not supported with these audio formats, the audio is output as Dolby Digital bitstream or down-mixed 2ch PCM (e.g., TV).

*2 **BD-V**: When playing BD-Video without secondary audio or clicking sound, the audio is output as the same format as if "BD-Video Secondary Audio" was set to "Off".

*3 When the connected equipment is not supported with multi channel surround, the audio is output as down-mixed 2ch PCM.

*4 **BD-V**: When the connected equipment is supported with 7.1 channel surround, the audio output is amplified from 5.1ch or 6.1ch to 7.1ch depending on the DTS, Inc. specifications.

*5 With PCM output, Dolby Digital EX becomes PCM audio decoded as Dolby Digital, DTS-ES recorded to DVD-Video becomes PCM audio decoded as DTS Digital Surround, and DTS-ES recorded to BD-Video becomes PCM audio decoded as DTS-ES.

*6 **BD-V**: When "BD-Video Secondary Audio" is set to "On", Dolby Digital EX is output as Dolby Digital and DTS-ES is output as DTS Digital Surround, however if playing BD-Video without secondary audio or clicking sound, the audio is output as the original format.

Enjoying High Bit rate Audio of BD-Video **BD-V**

This unit supports high bit rate audio (Dolby Digital Plus, Dolby TrueHD, DTS-HD High Resolution Audio and DTS-HD Master Audio) adopted in BD-Video.

In order to enjoy these audio formats, the following conditions are necessary. (Part shown in the shaded area of table given above)

NECESSARY CONNECTIONS

- HDMI AV OUT terminal: Connect this unit to your amplifier/receiver supporting HDMI (High Bit rate Audio) using a High Speed HDMI cable (⇒ 11).
- 7.1ch AUDIO OUT terminal **BD55**: Connect this unit to your amplifier/receiver supporting 7.1 channels using audio cables (⇒ 12).

NECESSARY SETTINGS (⇒ 9)

- Set "BD-Video Secondary Audio" to "Off".
- HDMI AV OUT terminal: Set "Dolby D/Dolby D +/Dolby TrueHD" or "DTS/DTS-HD" to "Bitstream" or "PCM".
- 7.1ch AUDIO OUT terminal **BD55**: Set "Analog Audio Output" to "7.1ch".

- The clicking sound on the menu and audio with secondary video in picture-in-picture mode (⇒ 21) is not output.

Regarding 24p output **BD-V**

Many BD-Video movie contents are recorded in 24 frames/second in accordance with the film materials. However, they will normally be output in 60 frames/second in accordance with the display format.

These can be output in 24p as the original. Therefore, high-quality video can be enjoyed, such as the improved clarity, enhanced perspective, etc.

NECESSARY CONNECTIONS

- Connect to a TV supporting 1080/24p input via an HDMI cable.

NECESSARY SETTINGS

- “24p Output”: “On” (⇒ 32)

Necessary settings

After connecting to the terminals, perform necessary settings.

“BD-Video Secondary Audio”

“Dolby D/Dolby D +/ Dolby TrueHD” “DTS/DTS-HD”

- 1) While stopped
Press [SETUP].
- 2) Press [▲, ▼] to select “Audio” and press [OK].
- 3) Press [▲, ▼] to select “Digital Audio Output” and press [OK].
- 4) Press [▲, ▼] to select “Dolby D/Dolby D +/Dolby TrueHD”, “DTS/DTS-HD”, or “BD-Video Secondary Audio” and press [◀, ▶] to select the option.

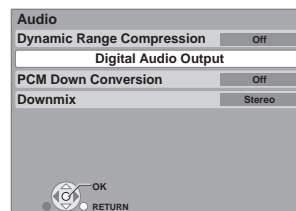

“Analog Audio Output” **BD55**

- 1) While stopped
Press [SETUP].
 - 2) Press [▲, ▼] to select “TV / Device Connection” and press [OK].
 - 3) Press [▲, ▼] to select “Analog Audio Output” and press [OK].
 - 4) Press [▲, ▼] to select the option and press [OK].
 - 5) Press [OK].
- The channel setting screen is displayed. (⇒ 34)

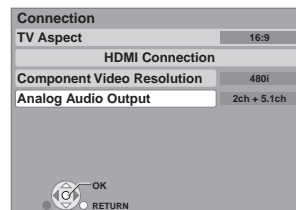

- For more information about settings, refer to page 31, 32, 34.

- When using the different terminal at the same time, the sound may not be output with the desired audio if the setting is incorrect.

In the following case, set “HDMI Audio Output” to “Off”. (⇒ 32)

- When connecting a compatible amplifier/receiver using 7.1ch AUDIO OUT/5.1ch AUDIO OUT terminals, and connecting a compatible television using HDMI AV OUT terminal
- When connecting a compatible amplifier/receiver using both 7.1ch AUDIO OUT/5.1ch AUDIO OUT terminals and HDMI AV OUT terminal if outputting the audio from analog terminals
- When connecting a compatible amplifier/receiver using DIGITAL AUDIO OUT terminals, and connecting a compatible television using HDMI AV OUT terminal

To return to the previous screen

Press [RETURN].

To exit the screen

Press [SETUP].

Connections

About terminal

- This unit offers several different types of audio and video connections.
- Your TV/receiver/amplifier may or may not support all the connections shown.
- If your system does not support HDMI, you will need to select one video connection and one audio connection.
- If your system supports HDMI, this one connection provides both the audio and video connection.

Video Connections (TV)

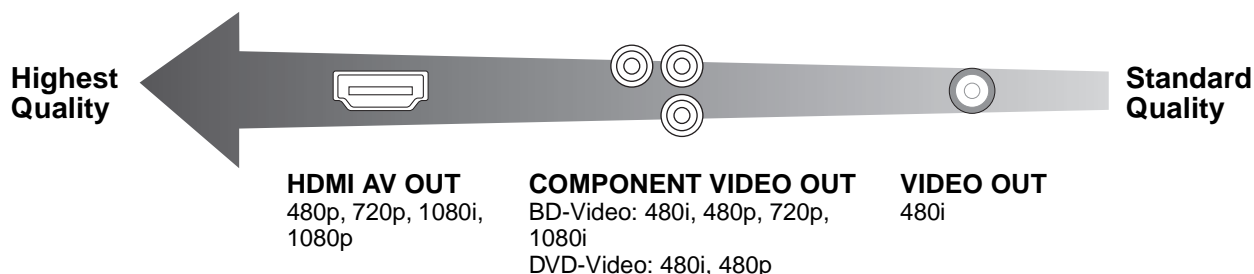

Digital Audio Connections (Receiver/Amplifier)



Analog Audio Connections (Receiver/Amplifier)

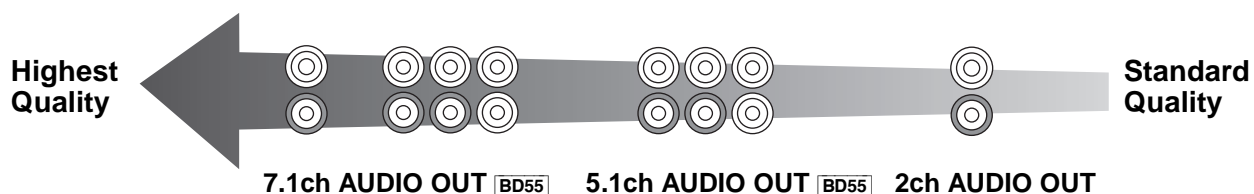

- Do not place the unit on amplifiers or equipment that may become hot. The heat can damage the unit.
- Before making any connections we strongly suggest that all units be temporarily disconnected from AC power.
- Do not connect video signals through a video recorder. Due to copy guard protection the picture may not be displayed properly

• **Non-HDMI-compliant cables cannot be utilized.**

• **Please use High Speed HDMI Cables that have the HDMI logo (as shown on the cover). It is recommended that you use Panasonic's HDMI cable. When outputting 1080p signal, please use HDMI cables 5.0 meters (16.4 ft) or less.**

Recommended part number:

RP-CDHG10 (1.0 m/3.3 ft), RP-CDHG15 (1.5 m/4.9 ft.), RP-CDHG20 (2.0 m/6.6 ft), RP-CDHG30 (3.0 m/9.8 ft.), RP-CDHG50 (5.0 m/16.4 ft.), etc.

• This unit incorporates HDMI (Deep color, x.v.Color, High Bit rate Audio) technology. (⇒ 46, 47)

Connecting to a television

A Connecting to your TV, via HDMI AV OUT

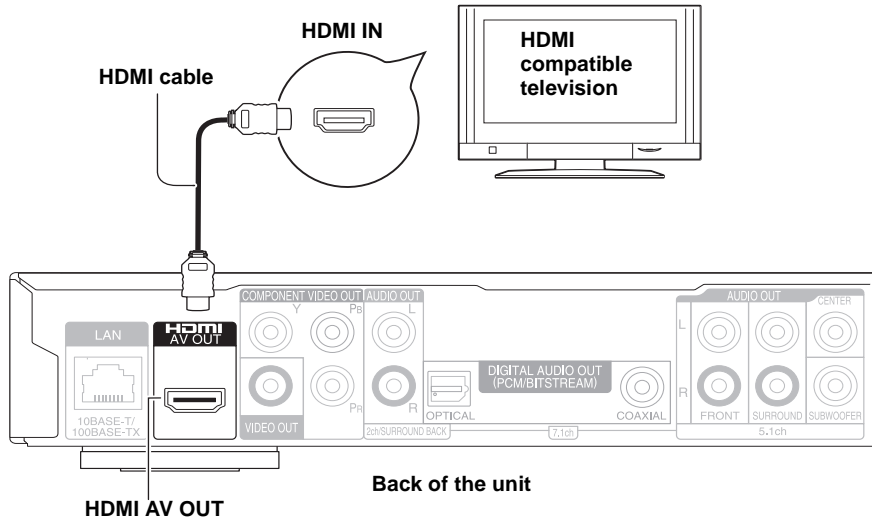

- “HDMI Video Mode” and “HDMI Audio Output” should be set to “On”. (⇒ 32)
- To experience better sound consider adding a surround sound receiver, using connections **D**, **E**, **F** or **G**. (⇒ 12, 13)
- The HDMI connection supports VIERA Link “HDAVI Control” (⇒ 26) when used with a compatible Panasonic TV.

B Connecting to your TV, via COMPONENT VIDEO OUT

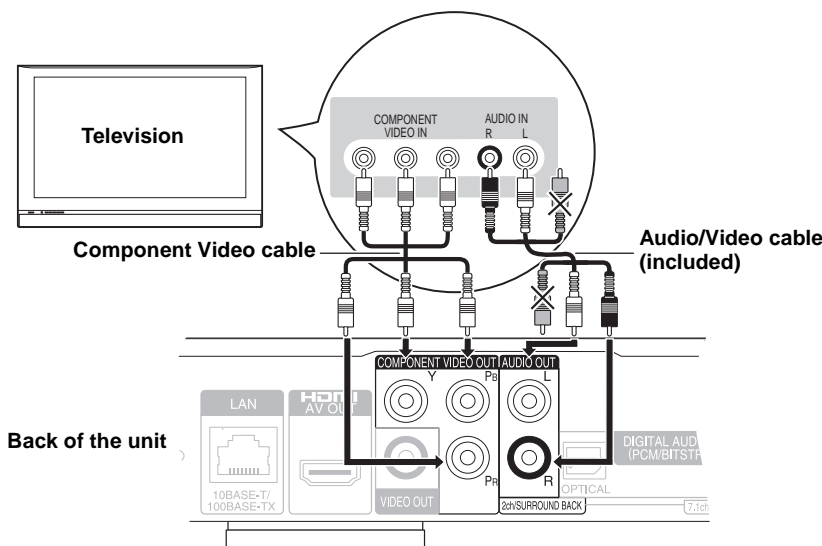

- **BD55**: “Analog Audio Output” should be set to “2ch (Downmix) + 5.1ch”. (⇒ 32)
- The Component Video cable does not carry audio, so you must also connect the L and R audio channels using the Audio/Video cable.
- To experience better sound consider adding a surround sound receiver, using connections **D**, **E**, **F** or **G**. (⇒ 12, 13) (Unplug the red and white plugs.)
- Connect terminals of the same color.
- Set the “Black Level Control” to “Darker”. (⇒ 31)
- Using the COMPONENT VIDEO OUT terminal, while playing DVD-Video, the video output resolution is limited to “480p”.
- Be sure your TV supports at least 480p. Set “Component Video Resolution” to “480p”, “720p” or “1080i”. (⇒ 32)
- If this unit is connected to an amplifier/receiver, etc. via an HDMI cable with “HDMI Video Mode” set to “On” (⇒ 32), the video will be fixed to 480i.

C Connecting to your TV, via VIDEO OUT

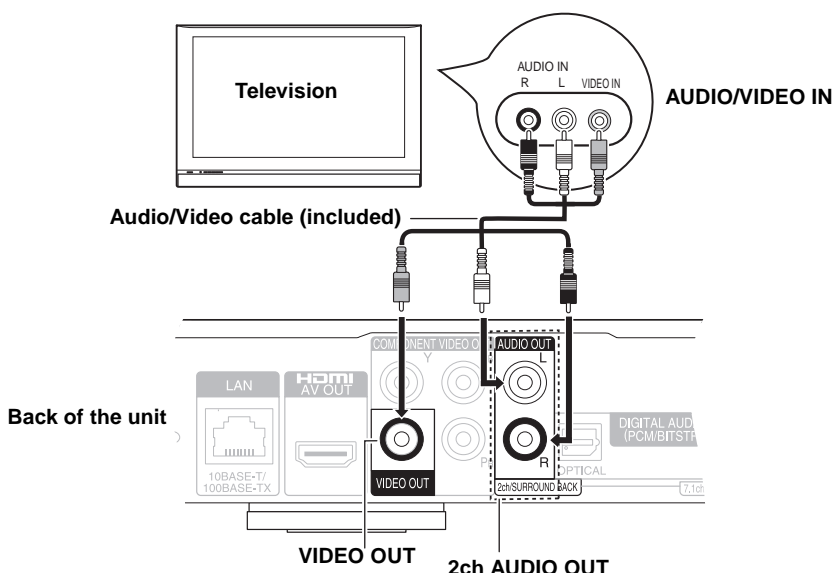

- **BD55**: “Analog Audio Output” should be set to “2ch (Downmix) + 5.1ch”. (⇒ 32)
- Using the two analog audio channels this connection provides, you will not be able to use any surround sound audio modes.
- To experience better sound consider adding a surround sound receiver, using connections **D**, **E**, **F** or **G**. (⇒ 12, 13) (Unplug the red and white plugs.)
- Connect terminals of the same color.
- High definition video cannot be viewed using this connection. To view high definition video, please use connection types **A** or **B**. (⇒ above)

Connections using a surround sound receiver/amplifier

D Installation using the HDMI connection

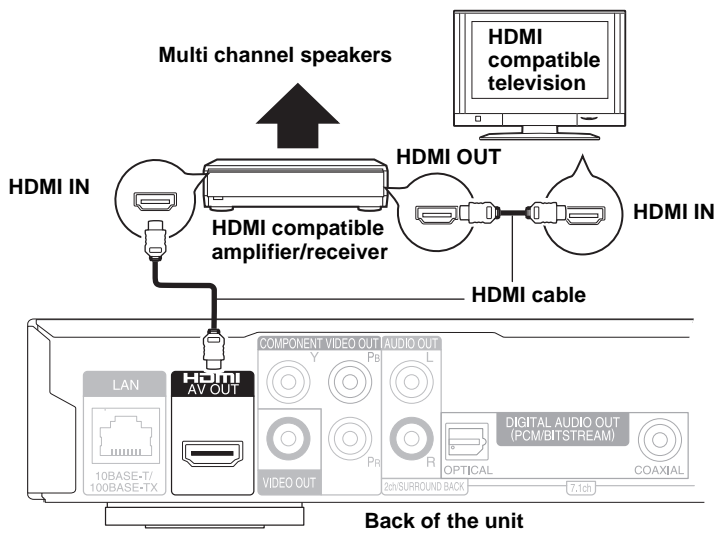

- "HDMI Video Mode" and "HDMI Audio Output" should be set to "On". (⇒ 32)
- "Digital Audio Output" : Depending on the connected amplifier/receiver. (⇒ 31)
- The HDMI connection supports VIERA Link "HDMI Control" (⇒ 26) when used with a compatible Panasonic TV.
- This unit comes equipped with a Dolby Digital Plus, Dolby TrueHD and DTS-HD decoder. When an amplifier/receiver with 7.1ch speakers that supports HDMI (High Bit rate Audio) is connected using High Speed HDMI cable, you can enjoy surround sound recorded with Dolby Digital Plus, Dolby TrueHD or DTS-HD. (⇒ 8)

E Connecting to 7.1ch AUDIO OUT terminal BD55

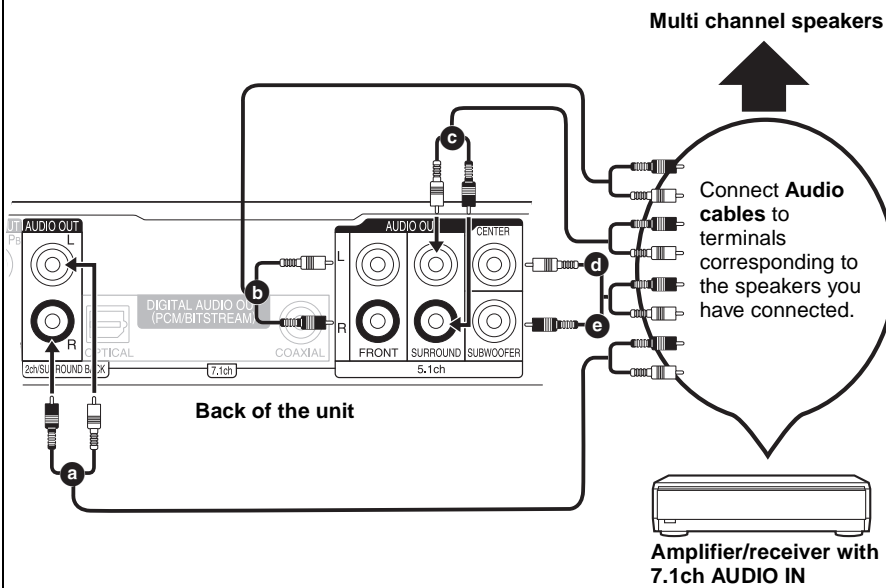

- "Analog Audio Output" should be set to "7.1ch". (⇒ 32)
- This unit comes equipped with a Dolby Digital Plus, Dolby TrueHD and DTS-HD decoder. When connected to a compatible amplifier/receiver using the 7.1ch AUDIO OUT terminals, you can enjoy surround sound recorded with Dolby Digital Plus, Dolby TrueHD or DTS-HD.
- When connecting amplifier/receiver or other devices with HDMI AV OUT terminal, set "HDMI Audio Output" to "Off". (⇒ 32) (Otherwise, depending on the specifications of connected devices, the audio from AUDIO OUT terminal may be output as two channels only.)
- When connecting a TV (⇒ 11, **A**) with HDMI AV OUT terminal, set "HDMI Audio Output" to "Off". (⇒ 32) (Otherwise, the sound may not be output with the desired audio.)
- Depending on how the disc was recorded, the audio may not be output properly on the number of channels desired.

Cable connections

- a** Surround back speaker (L/R)
- b** Front speaker (L/R)
- c** Surround speaker (L/R)
- d** Center speaker
- e** Subwoofer

F Connecting to 5.1ch AUDIO OUT terminal BD55

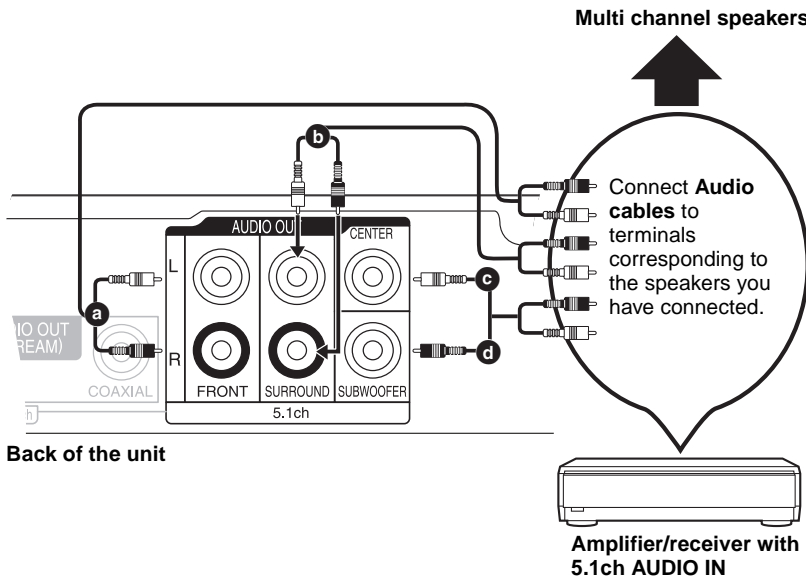

- “Analog Audio Output” should be set to “2ch (Downmix) + 5.1ch”. (⇒ 32)
- Using this connection, 7.1 channel surround is mixed down to 5.1 channel audio.
- When connecting amplifier/receiver or other devices with HDMI AV OUT terminal, set “HDMI Audio Output” to “Off”. (⇒ 32) (Otherwise, depending on the specifications of connected devices, the audio from AUDIO OUT terminal may be output as two channels only.)
- When connecting a TV (⇒ 11, **A**) with HDMI AV OUT terminal, set “HDMI Audio Output” to “Off”. (⇒ 32) (Otherwise, the sound may not be output with the desired audio.)
- Depending on how the disc was recorded, the audio may not be output properly on the number of channels desired.

Cable connections

- a** Front speaker (L/R)
- b** Surround speaker (L/R)
- c** Center speaker
- d** Subwoofer

G Installation using Coaxial BD55 /Optical Digital Audio connection

With COAXIAL

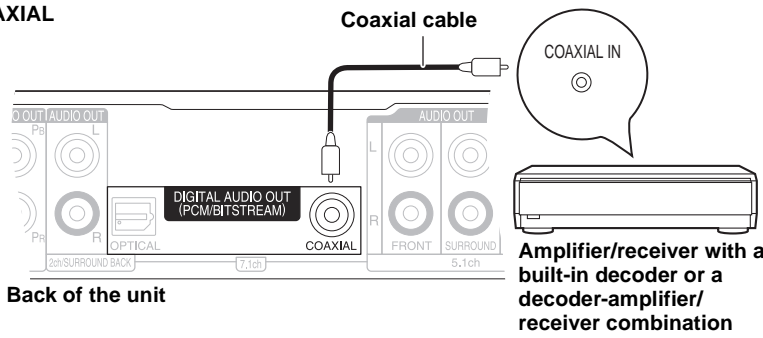

With OPTICAL

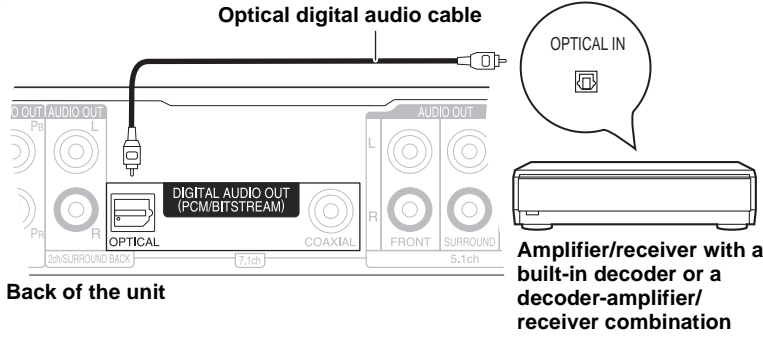

- Please set “Digital Audio Output” to the connection you will use, coaxial or optical digital. (⇒ 31)
- When connecting a TV (⇒ 11, **A**) with HDMI AV OUT terminal, set “HDMI Audio Output” to “Off”. (⇒ 32) (Otherwise, the sound may not be output with the desired audio.)

AC power connection

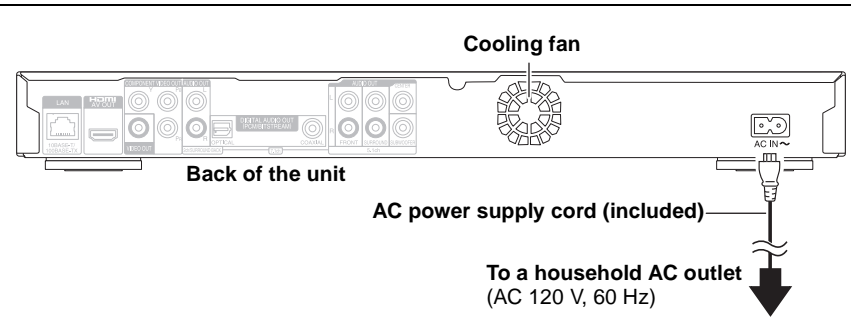

- For best results this unit should be connected directly to an AC outlet.
- This unit consumes a small amount of AC power (less than 0.6 W) even when turned off. In the interest of power conservation, if you will not be using this unit for an extended period of time, it can be disconnected.

Broadband network connection

- By connecting this unit to a broadband connection, this unit can support the BD-Live feature offered on some movie titles. BD-Live offers additional interactive media and games that are associated with the movie title. (⇒ 21)
- Once connected to a broadband connection, this unit can also automatically check for firmware updates.

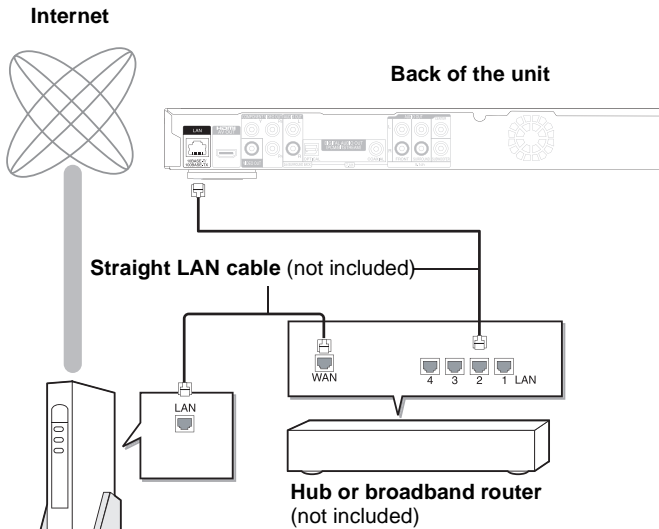

Telecommunications equipment (modem, etc.)

- After physically connecting this unit to your broadband connection, some configuration is required. (⇒ 17)
- With installation where your broadband modem is connected directly to your PC, a router must be installed.
- In case all available connection on your router is being used, a hub or switch can be installed to provide additional connections.
- Use a router that supports 10BASE-T/100BASE-TX.
- Inserting any cable other than a LAN cable in the LAN terminal can damage the unit.
- Use only shielded LAN cables when connecting to peripheral devices.

Firmware updates

Occasionally, Panasonic releases firmware updates for this BD Player. Firmware is embedded software that controls this unit's microprocessor. These updates may add or improve a feature of this unit. Firmware updates may also be released to correct operating irregularities that are discovered with certain movies. These updates are available at no charge.

Automatically check the firmware

This unit is capable of auto firmware check if it is connected to the Internet via a broadband connection.

When latest firmware version is available, the following screen is displayed.

Select "Yes" or "No".



- If "Yes" is selected, then follow the on-screen instructions.
- If "No" is selected, then manually update the firmware later. (⇒ below)

After the latest firmware is downloaded, the system will be restarted and the firmware will be updated.

When the system is restarted, the screen display disappears and "START" is displayed on the unit's display.



After the firmware is updated and the system is restarted, the following screen indicates that the firmware update has been completed.

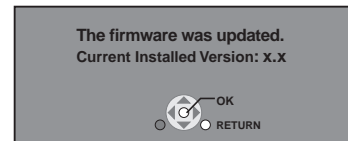

- During the update process, no other operations can be performed. Serious damage may occur if you turn the power off and/or press any buttons.
- Downloading will require several minutes. It may take longer or the Internet may not be connected depending on the connection environment. It is required that you use a broadband connection.
- When the unit is connected to the Internet, communication charges may be generated.
- If you do not want to check for the latest firmware version when the unit is turned on, set "Automatic Update Check" to "Off". (⇒ 33)

Manually updating the firmware

If the firmware update is not carried out when the unit is turned on, a message is displayed when displaying the FUNCTIONS menu.

The latest firmware is available.
Please update firmware in Setup.

You can manually update the firmware.

- 1) Press [SETUP].
- 2) Press [▲, ▼] to select "Others" and press [OK].
- 3) Press [▲, ▼] to select "Firmware Update" and press [OK].
- 4) Press [▲, ▼] to select "Update Now" and press [OK].
- 5) Press [◀, ▶] to select "Yes" and press [OK].

If downloading on this unit fails or this unit is not connected to the Internet, then you can download the latest firmware from the following website and burn it to a CD-R to update the firmware.

<http://panasonic.net/support/>
(This site is in English only.)

Remote control and unit reference guide

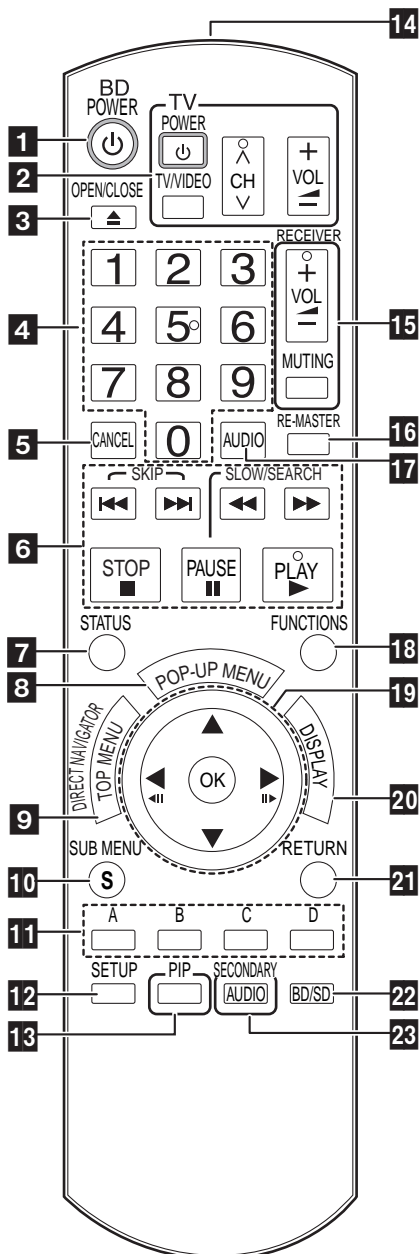

- 1** Turn the unit on and off (⇒ 16)
- 2** TV operation buttons (⇒ 16)
You can operate the TV through the unit's remote control.
[TV POWER] : Turn the television on and off
[TV/VIDEO] : Switch the input channel
[^ v CH] : Channel select
[+ - VOL] : Adjust the volume
- 3** Open or close the disc tray (⇒ 19)
- 4** Numbered buttons
Select title numbers, etc./Enter numbers (⇒ 19)
- 5** Cancel
- 6** Basic playback control buttons (⇒ 19)
- 7** Show status messages (⇒ 20)
- 8** Show Pop-up menu (⇒ 19)
- 9** Show Top menu/Direct Navigator (⇒ 19)
- 10** Show sub menu (⇒ 22)
- 11** These buttons are used when operating a BD-Video disc that includes Java™ applications (BD-J). For more information about operating this kind of disc, please read the instructions that came with the disc.
The [A] and [B] buttons are also used with the "Title View", "Picture View" and "Album View" screens (⇒ 22).
- 12** Show Setup menu (⇒ 30)
- 13** Switch on/off Secondary Video (Picture-in-picture) (⇒ 21)
- 14** Transmit the remote control signal
- 15** Receiver operation buttons (⇒ 16)
You can operate an amplifier/receiver through the unit's remote control.
[+ - VOL] : Adjust the volume
[MUTING] : Mute the sound
- 16** Reproduce more natural audio (⇒ 20)
- 17** Select audio (⇒ 20)
- 18** Show FUNCTIONS menu (⇒ 20)
- 19** Selection/OK, Frame-by-frame (⇒ 20)
- 20** Show on-screen menu (⇒ 28)
- 21** Return to previous screen
- 22** Select disc drive or SD card drive (⇒ 19)
- 23** Switch on/off Secondary Audio (⇒ 21)

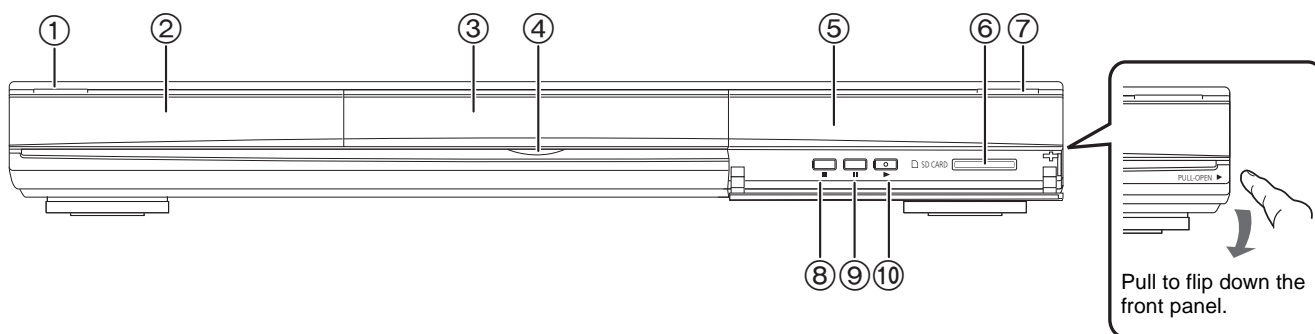

- 1** **POWER button (POWER ⏻/⏻)** (⇒ 16)
Press to switch the unit from on to standby mode or vice versa. In standby mode, the unit is still consuming a small amount of power.
- 2** Display

| | |
|----------------|-------------------|
| Disc indicator | SD Card indicator |
|----------------|-------------------|

The indicator blinks when reading data from a disc or card, or writing data to a card.
- 3** Disc tray (⇒ 19)
- 4** **BD55**: SD Card LED
 - It is possible to set the LED to turn on/off. (⇒ 32, SD Card LED Control)
- 5** Remote control signal sensor (⇒ 5)
- 6** SD card slot (⇒ 22)

- 7** Open or close the disc tray (⇒ 19)
- 8** Stop (⇒ 19)
- 9** Pause (⇒ 19)
- 10** Start play (⇒ 19)

Rear panel terminals (⇒ 10–14)

Easy Setting

After connecting your new player and pressing the power button, a screen for the basic settings will appear.

Preparation

Turn on the television and select the appropriate video input on the television.

1 Press [⏻ BD POWER].

Setup screen appears.

- If this unit is connected to a Panasonic TV (VIERA) supporting HDAVI Control 2 or HDAVI Control 3 via an HDMI cable, then the "On-screen Language" and "TV Aspect" setting information on the TV are captured from the TV.

2 Follow the on-screen instructions and make the settings with [▲, ▼] and [OK].

"On-screen Language", "TV Aspect" and "Analog Audio Output" [BD55] are set. (⇒ 32)

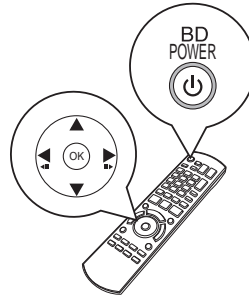

- You can perform this setup anytime by selecting "Easy Setting" in the Setup menu. (⇒ 33)
- You can also change these settings individually. (⇒ 32)

Reprogramming the remote control for TV/amplifier/receiver control

You can operate the TV or amplifier/receiver using the unit's remote control.

Point the remote control at the television or amplifier/receiver.

1 For televisions

Input the 4-digit code with the numbered buttons while pressing [⏻ TV POWER].

For amplifiers/receivers

Input the 4-digit code with the numbered buttons while pressing [MUTING].

e.g., 0001: [0] ⇒ [0] ⇒ [0] ⇒ [1]

2 Test by turning on the television or adjusting the volume of the amplifier/receiver.

- If your television or amplifier/receiver brand has more than one code listed, select the one that allows correct operation.
- If your television or amplifier/receiver brand is not listed or if the code listed for them does not allow control of your television or amplifier/receiver, this remote control is not compatible with them. Use their remote control.
- When audio is muted, press [MUTING] again.

| Brand | TV Code |
|-----------------|---|
| Panasonic | 0051/0055/0250/0650 |
| ADVENT | 0761/0783/0815/0817/0842 |
| AKAI | 0030/0098/0672/0702/0812 |
| AMERICA ACTION | 0180 |
| AOC | 0003/0019/0030/0052/0137/0185 |
| APEX DIGITAL | 0748/0765/0767/0879/0890 |
| AUDIOVOX | 0003/0092/0180/0451/0623/0802/0875/1937 |
| AXION | 1937 |
| BANG & OLUFSEN | 0620/1620 |
| BROKSONIC | 0003/0236/0463 |
| CASIO | 0611/1205 |
| DAEWOO | 0019/0039/0066/0067/0091/0092/0451/0623/0661/0672/1661 |
| EMERSON | 0019/0038/0039/0154/0158/0171/0177/0178/0179/0180/0181/0182/0183/0185/0236/0270/0280/0282/0463/0623 |
| ENVISION | 0030/0813 |
| EPSON | 0833/0840 |
| FISHER | 0154/0159 |
| FUJITSU | 0179/0186/0683/0809/0853 |
| GE | 0021/0027/0029/0047/0051/0055/0135/0138/0174/0178/0251/0279/0282/0451/0747/1347/1447 |
| GOLDSTAR | 0019/0030/0032/0106/0178/0317/0409/0442/0457/0700/0856/1178/1265 |
| GO VIDEO | 0886 |
| HAIER | 0768/1034 |
| HANNSPREE | 1348/1351/1352 |
| HEWLETT PACKARD | 1088/1089/1101/1494/1502 |
| HISENSE | 0748 |
| HITACHI | 0016/0032/0038/0056/0095/0097/0145/0151/0173/0227/0279/0409/0413/1145 |
| INFOCUS | 0736/0738/0741/0752/0781/1164/1516 |
| JVC | 0036/0053/0069/0160/0169/0182/0731/1253 |
| KLH | 0765/0767 |
| LG | 0019/0030/0032/0106/0178/0317/0409/0442/0457/0700/0856/1178/1265 |
| LOEWE | 0136 |
| MAGNAVOX | 0020/0024/0028/0030/0036/0054/0096/0179/0186/0187/0230/0386/0706/0802/1254/1454 |
| MARANTZ | 0030/0054/0444/0704/0854/0855/1154 |
| MEMOREX | 0016/0106/0150/0154/0178/0179/0463 |

| Brand | TV Code |
|------------------|---|
| MITSUBISHI | 0014/0019/0093/0098/0150/0155/0178/0331/0358/0836/0868/1250 |
| NORCENT | 0748/0824/1089 |
| OPTOMA | 0887 |
| ORION | 0179/0236/0463/1463 |
| PHILIPS | 0054/0690/1154/1454 |
| PHILIPS MAGNAVOX | 0020/0024/0028/0030/0036/0054/0096/0179/0186/0187/0230/0386/0690/0706/0802/1154/1254/1454 |
| PIONEER | 0038/0166/0172/0679/0866 |
| POLAROID | 0765/0865/1262/1276/1314/1316/1326/1327/1328/1341/1498/1523 |
| PROSCAN | 0047/0747/1347/1447 |
| PROVIEW | 0835/1401/1498 |
| RCA | 0018/0019/0029/0038/0047/0090/0135/0174/0278/0679/0747/1047/1147/1247/1347/1447/1547 |
| RUNCO | 0017/0030/0251/0497/0603 |
| SAMPO | 0030/0032/0039/0052/0100/0110/1755 |
| SAMSUNG | 0019/0030/0032/0056/0060/0178/0329/0408/0427/0587/0702/0766/0812/0814/1060 |
| SANSUI | 0463 |
| SANYO | 0088/0107/0146/0154/0159/0232/0484/0799/0893 |
| SHARP | 0039/0093/0153/0157/0165/0220/0281/0386/0398/0491/0688/0818/0851 |
| SONY | 0000/0011/0080/0111/0273/0353/0810/0834/0867/1100 |
| SVA | 0587/0748/0768/0865/0870/0871/0872 |
| SYLVANIA | 0020/0028/0030/0054/0065/0096/0171/0381 |
| SYMPHONIC | 0171/0180 |
| SYNTAX-BRILLIAN | 1007/1144/1240/1255/1257/1258/1331 |
| TATUNG | 0003/0049/0055/0396/1101/1756 |
| THOMSON | 0209/0210/0047 |
| TOSHIBA | 0036/0060/0149/0154/0156/0650/0832/0845/1156/1164/1256/1265/1356/1656/1704 |
| ULTRA | 0391 |
| VIEWSONIC | 0857/0864/0885/1755 |
| WESTINGHOUSE | 0885/0889/0890/1282/1577 |
| YAMAHA | 0019/0030/0769/0833/0839 |
| ZENITH | 0016/0017/0092/0178/0463/1265 |

| Brand | Amplifier Code | Receiver Code |
|-----------|----------------|--|
| Panasonic | 0308 | 1308/0039/0367/1641/2001/2002 |
| TECHNICS | 0308 | 1308/0039/0208 |
| BOSE | 0674 | 1229/0639/1253/1933 |
| DENON | | 1360/0004/0121/0273/1142/1306/1311 |
| HARMAN | | 0110/0189/1289/1306 |
| KARDON | | 0110/0189/1289/1306 |
| KENWOOD | | 1313/0027/0042/0077/0186 |
| KLH | | 1390/1412/1428 |
| LINN | | 0189 |
| MARANTZ | | 1189/1269/0039/0189/0128/1120/1289 |
| MCINTOSH | 0251 | 1289 |
| NAD | | 0320 |
| ONKYO | | 0135/0380/1298/1320 |
| PHILIPS | | 1189/1269/0189/0391/1120/1266/1368 |
| PIONEER | 0823 | 1023/0150/0244/0531/0630/1343/1384 |
| QUASAR | | 0039 |
| RCA | 0823 | 1023/1609/1254/0054/0530/0531/1074/1390/1511 |
| SAMSUNG | | 1295 |
| SANYO | | 1251/1469/1801 |
| SHARP | | 0186/1361 |
| SHERWOOD | | 0491/0502/1077/1423/1517/1653 |
| SONY | 0815/1126 | 1622/0158/0168/0474/1367/1529/1658/1758 |
| TEAC | | 0463/1074/1390 |
| TOSHIBA | | 0135 |
| YAMAHA | 0354 | 1023/0176/0186/1331 |

Network settings

These settings are used if you will connect this unit to the Internet.

- The connection to the Internet may take time or the Internet may not be connected depending on the connection environment. (⇒ 33)
It is required that you use a broadband connection.

Preparation

- Connect to a broadband network. (⇒ 14)

Testing the connection

Always test the connection when a LAN cable is connected or when new "IP Address/DNS Settings" have been made.

- 1 Press [SETUP].
- 2 Press [▲, ▼] to select "Network" and press [OK].
- 3 Press [▲, ▼] to select "IP Address/DNS Settings" and press [OK].
- 4 Press [▲, ▼] to select "Connection Test" and press [OK].

IP Address/DNS Settings

| | |
|--------------------------------------|-----|
| Connection Test | --- |
| IP Address Auto Configuration (DHCP) | On |
| IP Address | --- |
| Subnet Mask | --- |
| Default Gateway | --- |
| DNS Auto Configuration (DHCP) | On |
| Primary DNS | --- |
| Secondary DNS | --- |
| Auto Detect Connection Speed | On |
| Connection Speed Setting | --- |

OK RETURN

"Testing": The test is in progress.

"Pass": The connection is completed.
Press [RETURN] to exit.

"Fail": Please check the connection and settings.
(⇒ 36)

- If the connection test fails, it may be necessary to set the MAC address of this unit at the router side. The MAC address can be displayed by pressing [SETUP] and selecting "Network".

Network

IP Address/DNS Settings

Proxy Server Settings

MAC Address: xx-xx-xx-xx-xx-xx

OK RETURN

Setting the IP address

In most cases, default settings can normally be used without making any changes.

Set the IP address only when the router has no DHCP server functions or when the router's DHCP server function is disabled.

After performing steps 1-3 (⇒ left)

- 4 Press [▲, ▼] to select "IP Address Auto Configuration (DHCP)" and press [◀, ▶] to select "Off".
- 5 Press [▲, ▼] to select "IP Address", "Subnet Mask" or "Default Gateway" and press [OK].
- 6 Enter numbers with the numbered buttons and press [OK].
- 7 Press [◀, ▶] to select "Yes" and press [OK].

- After checking the specifications for your broadband router, enter each number. If the number is unknown, then check the number of other devices such as personal computers connected via a LAN cable. Assign a different number from those of other devices for the "IP Address" and the same number for others.
- If a wrong number is entered, then press [CANCEL].
- The numeric input range is between 0 and 255.

Setting the DNS-IP

In most cases, default settings can normally be used without making any changes.

When setting an assigned DNS server from your Internet service provider, perform the following settings.

After performing steps 1-3 (⇒ left)

- 4 Press [▲, ▼] to select "DNS Auto Configuration (DHCP)" and press [◀, ▶] to select "Off".
- 5 Press [▲, ▼] to select "Primary DNS" or "Secondary DNS" and press [OK].
- 6 Enter numbers with the numbered buttons and press [OK].

Primary DNS

Please input Primary DNS and press [OK]. Press [CANCEL] to delete the selected character. To clear this setting, delete all characters and press [OK].

192 . 1 . .

0 - 9 Number

- 7 Press [◀, ▶] to select "Yes" and press [OK].

- Follow the instructions given by your Internet service provider and enter the numbers. If the number is unknown, then check the number of other devices such as personal computers connected via a LAN cable and assign the same number.
- If a wrong number is entered, then press [CANCEL].
- The numeric input range is between 0 and 255.

Network settings

Setting the connection speed

When the connection test results in "Fail" after the IP and DNS-IP addresses are assigned, perform the following settings.

After performing steps 1–3 (⇒ 17)

- Press [▲, ▼] to select "Auto Detect Connection Speed" and press [◀, ▶] to select "Off".
- Press [▲, ▼] to select "Connection Speed Setting" and press [◀, ▶] to select a connection speed.

- Select a connection speed in accordance with the environment of the network connected.
- When the settings are changed, the network connection may be disabled depending on the device.

Setting the proxy server

In most cases, default settings can normally be used without making any changes.

Please use this setting when instructed to by your Internet service provider.

- Press [SETUP].
- Press [▲, ▼] to select "Network" and press [OK].
- Press [▲, ▼] to select "Proxy Server Settings" and press [OK].
- Press [▲, ▼] to select "Proxy Address" and press [OK].

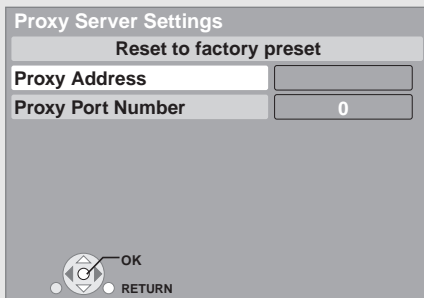

- Press [▲, ▼, ▶, ◀] to select a character and press [OK].

Text field: shows the text you have entered

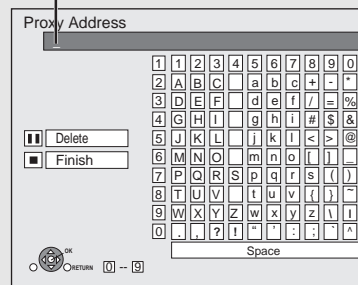

Using the numbered buttons to enter characters e.g., entering the letter "F"

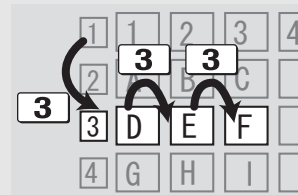

- Press [3] to move to the 3rd row.
- Press [3] twice to highlight "F".
- Press [OK].

Repeat this step to enter other characters.
• Press [Delete] to delete.

- Press [Finish] when you complete the entry.
- Press [▲, ▼] to select "Proxy Port Number" and press [OK].
- Enter numbers with the numbered buttons and press [OK].

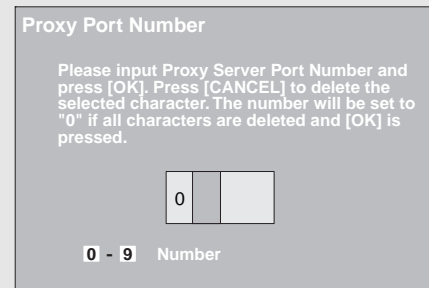

- Press [◀, ▶] to select "Yes" and press [OK].

- The specified ports may be blocked and not be able to be used depending on the network environment.

In order to restore the default settings

After performing steps 1–3

- Press [▲, ▼] to select "Reset to factory preset" and press [OK].
- Press [◀, ▶] to select "Yes" and press [OK].

Basic play (Playing video contents)

Instructions for operations are generally described using the remote control in these operating instructions.

DivX: **BD55** only

Preparation

Turn on the television and select the appropriate video input on the television.

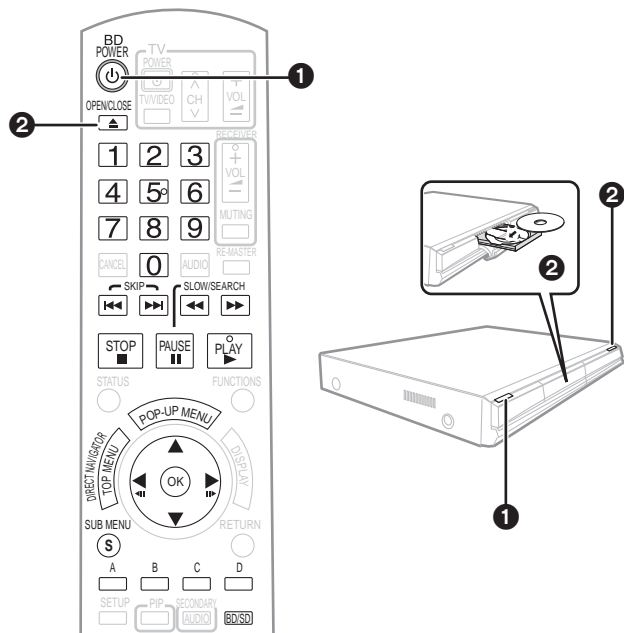

- 1 Press [**BD POWER**] to turn on the unit.
- 2 Press [**OPEN/CLOSE**] to open the disc tray and insert the disc.

- Insert double-sided discs so the label for the side you want to play is facing up.
- DVD-RAM: Remove discs from their cartridges before use.
- Press the button again to close the tray. Play starts.
- If the menu is displayed, press [**▲**, **▼**, **◀**, **▶**] to select the item and press [OK].
- If the screen prompting you to use the color buttons appears, continue to operate with the color buttons on the remote control.
- DISCS CONTINUE TO ROTATE WHILE MENUS ARE DISPLAYED. Press [**■**] when you have finished playback to protect the unit's motor, your television screen and so on.
- The producers of the disc can control how discs are played. So you may not always be able to control play as described in these operating instructions. Read the disc's instructions carefully.
- When playing a set of two or more BD-Video discs, the menu screen may continue to display even if the disc has been ejected.

e.g.,



To switch drives

Press [BD/SD] to select "BD" to play a disc.

- If a disc or an SD card is inserted while the unit is stopped, the drive switches automatically depending on the inserted media.

To display menus

BD-V **AVCHD** **DVD-VR** **DVD-V**

Press [TOP MENU/DIRECT NAVIGATOR].

To show Pop-up menu **BD-V**

The Pop-up menu is a special feature available with some BD-Video discs. This menu may vary with discs. For the operating method, refer to the instructions for the disc.

- 1) Press [POP-UP MENU].
 - 2) Press [**▲**, **▼**, **◀**, **▶**] to select the item and press [OK].
- Pop-up menu also appears by pressing [SUB MENU] and selecting "Pop-up Menu".
 - Press [POP-UP MENU] to exit the screen.

Other operations during play

(These functions may not work depending on the disc.)

STOP

The stopped position is memorized.

Resume play function

Press [**▶**] (PLAY) to restart from this position.

- The position is cleared if the tray is opened or you press [**■**] several times to display "STOP" on unit's display.
- **BD-V:** On BD-Video discs including BD-J (⇒ 46), the resume play function does not work.
- **CD** **MP3** **DivX:** The position is cleared if the unit is turned off.

PAUSE

- Press [**||**] again or [**▶**] (PLAY) to restart play.

SLOW/SEARCH

The speed increases up to 5 steps.

- Press [**▶**] (PLAY) to revert to normal playback speed.
- For some discs, the speed may not change.

Search

While playing, press [**◀◀**] or [**▶▶**].

- **BD-V** **AVCHD** **DVD-VR** **DVD-V:** Audio is heard during first level of forward search.
- **DivX:** Audio is not heard during all levels of search.
- **CD** **MP3:** The speed is fixed to a single step.

Slow-motion

While paused, press [**◀◀**] or [**▶▶**].

- **BD-V** **AVCHD:** Forward direction [**▶▶**] only.
- **DVD-VR:** If continued for approx. 5 minutes, slow-motion play pauses automatically.

SKIP

Skip to the title, chapter or track you want to play.

- Each press increases the number of skips.
- **DivX:** Backward direction [**◀◀**] only.



Direct Play

During playback, you can access specific recordings or scenes through direct entry of the numbered buttons.

Play starts from the selected title or chapter.

BD-V **AVCHD**

e.g., 5: [0] ⇒ [0] ⇒ [5]

15: [0] ⇒ [1] ⇒ [5]

DVD-V

e.g., 5: [0] ⇒ [5]

15: [1] ⇒ [5]

- While stopped (the image on the right is displayed on the screen), the title is designated. While playing, the chapter is designated.



Basic play (Playing video contents)



Frame-by-frame

While paused, press [◀] (◀◀) or [▶] (▶▶).

Each press shows the next frame.

- Press and hold to change in succession forward or backward.
- Press [▶] (PLAY) to revert to normal playback speed.
- **BD-V** **AVCHD**: Forward direction [▶] (▶▶) only.

Screen Aspect

When black bars are shown at the top, bottom, left, and right sides of the screen, you can enlarge the image to fill the screen.

- 1 Press [SUB MENU].
- 2 Press [▲, ▼] to select "Screen Aspect" and press [OK].
- 3 Press [◀, ▶] to select "Side cut" or "Zoom".

Normal: Normal output

Side cut: The black bars on the right and left sides of the 16:9 image disappear and the image is enlarged. Please note that the right and left sides of the image are cut off when the black bar is not displayed.

Zoom: The black bars on the top and bottom sides of the 4:3 image disappear and the image is enlarged. Please note that the top and bottom sides of the image are cut off when the black bar is not displayed.

- **BD-V**: "Side cut" and "Zoom" do not have any effect.
- **DVD-V**: "Side cut" does not have any effect.
- When "TV Aspect" (⇒ 32) is set to "4:3 Pan & Scan" or "4:3 Letterbox", the "Zoom" effect is disabled.

STATUS



Status messages

The status messages give you information about what is currently being played. Each time you press [STATUS], the information displayed will change.

e.g. **BD-V**

Type of disc Play status

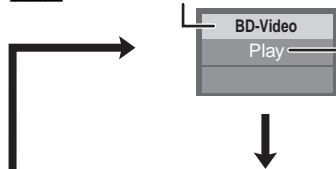

No display

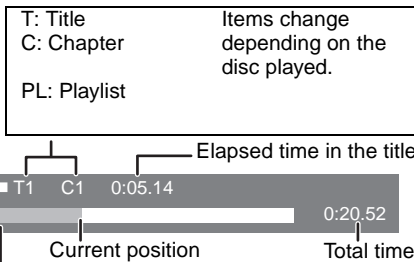

Depending on the kind of disc or the playback status, this display may not appear.



Changing audio during play

BD-V **AVCHD** **DVD-V**

e.g. **DVD-V**



English is selected.

You can change the audio channel number each time you press the button. This allows you to change the soundtrack language (⇒ 28, Soundtrack), etc.

DVD-VR **DivX**

AudioLR → AudioL → Audio R



"AudioLR" is selected

RE-MASTER



Reproducing more natural audio (Discs recorded at 48 kHz or less)

This feature gives you a more natural sound by adding higher frequency signals not recorded on the track.

Press [RE-MASTER] to select "Re-master 1", "Re-master 2" or "Re-master 3".

Select the one that you like best.

| Setting | When playing LPCM sound Type of music | Other types of sound Effect level |
|-------------|--|--------------------------------------|
| Re-master 1 | High tempo (e.g., pop and rock) | Light |
| Re-master 2 | Various tempos (e.g., jazz) | Medium |
| Re-master 3 | Low tempo (e.g., classical) | Strong |
| Off | Off | Off |

- This function is effective for audio from the HDMI terminal or the DIGITAL AUDIO OUT terminal only when "Dolby D/Dolby D+/Dolby TrueHD" or "DTS/DTS-HD" is set to "PCM". (However, in this case, audio is output as 2ch from the DIGITAL AUDIO OUT terminal.)

Showing FUNCTIONS menu

Some functions of this unit can be operated from the FUNCTIONS menu.

1 Press [FUNCTIONS].

- Items to be displayed may vary with the media.

2 Press [▲, ▼] to select the item and press [OK].

e.g.,

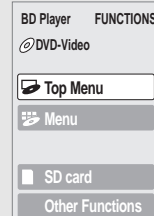

- **Top Menu**
- **Menu**
- **Playback**
- **SD card**
- **BD/DVD/CD**
- **Other Functions**

Switches to the SD drive.

Switches to the disc drive.

"Playlists":

You can play playlists created on DVD-VR. Press [▲, ▼, ◀, ▶] to select the playlist and press [OK].

"Setup" (⇒ 30)

"Card Management" (⇒ 21)

Enjoying the advanced functions on BD-Video discs BD-V

Some BD-Video discs are equipped with an advanced function added to the BD-Video standard to provide various interactive features.

| Feature | Secondary video/audio (PIP) | Virtual package | Internet connectivity |
|--|-----------------------------|-----------------|-----------------------|
| BD-Video BD-ROM version 2 Profile 1 version 1.0 | — | — | — |
| BONUSVIEW BD-ROM version 2 Profile 1 version 1.1/ Final Standard Profile | ○ | ○ | — |
| BD-Live BD-ROM version 2 Profile 2 | ○ | ○ | ○ |

- This unit supports through BD-ROM version 2 Profile 2.
- The usable functions and the operating method may vary with each disc. For details, refer to the instructions for the disc.
- These discs may not be on sale in certain regions.

What is secondary video/audio?

This is a function of BD-Video that plays the primary video and secondary video simultaneously. For instance, the function is capable of playing the original movie as the primary video while playing video commentary from the film director on a small screen as a secondary video.

What is Virtual package?

This is a function of BD-Video that plays discs and other media (⇒ 46, Local storage) simultaneously. For instance, the function is capable of playing sub contents (secondary video, secondary audio, and subtitles) which are automatically recorded to other media from the Internet or disc. In order to use the Internet feature, you must have this unit connected to a broadband network. (⇒ 14)

What is Internet connectivity?

BD-Live lets users connect this player to the Internet to download data such as images and subtitles, and to join in quizzes and multi-player interactive games that are linked to bonus movie content contained on BD-Video discs.

In order to use the Internet feature, you must have this unit connected to a broadband network. (⇒ 14)

Playing secondary video (picture-in-picture) and secondary audio

To turn on/off secondary video
Press [PIP].

To turn on/off audio with the secondary video
Press [SECONDARY AUDIO].

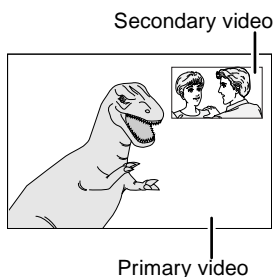

- During search/slow-motion or frame-by-frame, only the primary video is displayed.
- When the "BD-Video Secondary Audio" setting in the "Digital Audio Output" menu is set to "Off", secondary audio will not be played, even when the [SECONDARY AUDIO] button is pressed. Please be sure "BD-Video Secondary Audio" is set to "On". (⇒ 31)

Virtual package

For this unit, data is copied to an SD card.

The required available capacity on the card may vary with the disc. For details, refer to the instructions for the disc.

Formatting SD cards/Deleting data

- 1) Insert an SD card (⇒ 22).
- 2) Press [FUNCTIONS].
- 3) Press [▲, ▼] to select "Other Functions" and press [OK].
- 4) Press [▲, ▼] to select "Card Management" and press [OK].
- 5) Press [▲, ▼] to select "BD-Video Data Erase" or "Format SD Card" and press [OK].
- 6) Press [◀, ▶] to select "Yes" and press [OK].
- 7) Press [◀, ▶] to select "Start" and press [OK].

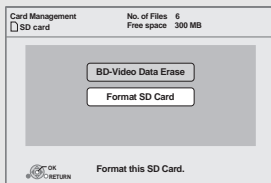

- Data cannot be copied in the following cases.
 - The card is protected.
 - Available capacity on the card is too small. Delete unnecessary data or use a new card.
- If you are using an SD card that was just purchased, it is a good idea to format the card in this unit before using it.
- If the SD card you use is formatted, all data on the card will be erased. It cannot be recovered.
- While using this feature, do not remove the SD card. Doing so will cause playback to stop.
- If you experience any problems, first, try formatting the SD card in this unit.

Internet connectivity

When discs supporting BD-Live are played back, the player or disc IDs may be sent to the content provider via the Internet.

- You can restrict Internet access. (⇒ 30)

1 Insert a disc (⇒ 19).

- "Title View" screen is displayed. e.g.,

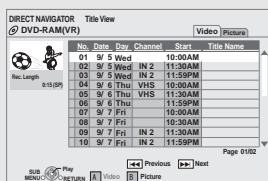

2 Press [▲, ▼] to select the title and press [SUB MENU].

3 Press [▲, ▼] to select "View Chapters" and press [OK].

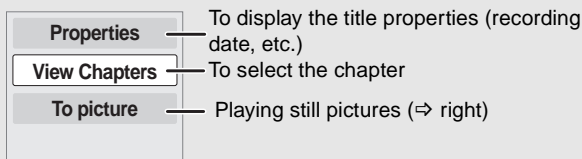

4 Press [◀, ▶] to select the chapter and press [OK].

e.g.,

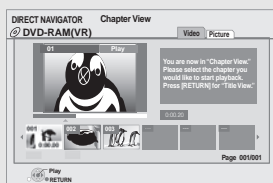

This feature allows you to play still pictures that were recorded to BD-RE, DVD-RAM, CD-R/RW media as well as to an SD card.

1 Insert a disc (⇒ 19) or an SD card (⇒ below).

- If a disc or an SD card containing data in different file formats is inserted, the file selection menu may be displayed. e.g.,
- SD card:
- Press [▲, ▼] to select "Picture (JPEG) Navigator" and press [OK].
- CD-R/RW:
- Press [▲, ▼] to select "Pictures" and press [OK].

BD-RE, DVD-RAM
"Album View" screen is displayed.

CD-R/RW, SD card
"Picture View" screen is displayed.
⇒ Go to step 3

e.g.,

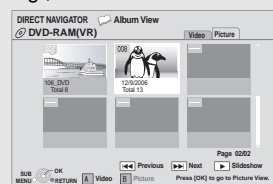

e.g.,

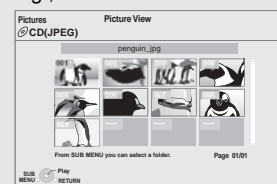

- When the "Title View" screen is displayed, press the [B] button to switch to the "Album View" screen.

2 Press [▲, ▼, ▶, ◀] to select the album and press [OK].

3 Press [▲, ▼, ▶, ◀] to select the still picture and press [OK].

e.g.,

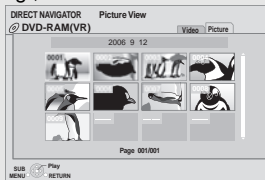

- Press [▶, ◀] to display the previous or next still picture.
- Press [◀◀, ▶▶] to show other pages.

To return to the previous screen

Press [RETURN].

To exit the screen

Press [DIRECT NAVIGATOR].

CD-R/RW, SD card

To switch from other menus to JPEG menu

(If the media contains data in different file formats)

- 1) Press [FUNCTIONS].
- 2) Press [▲, ▼] to select "Menu" and press [OK].
- 3) Press [▲, ▼] to select "Pictures"/"Picture (JPEG) Navigator" and press [OK].

Inserting a card

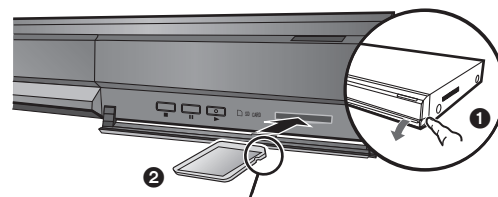

Insert the card's label up, positioning the cut off corner to the right.

- 1 Pull to flip down the front panel.
- 2 Insert the SD card into the SD card slot.
 - Press on the center of the card until it clicks into place.

Removing the card

Press on the center of the card and pull it straight out.

Useful functions during still picture play

Start Slideshow

You can display still pictures one by one at a constant interval.

BD-RE, DVD-RAM

- 1 While the "Album View" screen is displayed Press [**▲**, **▼**, **◀**, **▶**] to select the album and press [**SUB MENU**].
- 2 Press [**▲**, **▼**] to select "Start Slideshow" and press [**OK**].

• You can also start slideshow by pressing [**▶**] (PLAY) after selecting the album.

CD-R/RW, SD card

- 1 While the "Picture View" screen is displayed Press [**SUB MENU**].
- 2 Press [**▲**, **▼**] to select "Start Slideshow" and press [**OK**].

To stop slideshow

Press [**■**].

Slideshow with music

SD card only

If a music CD is inserted in the disc tray while playing slideshows, the music CD starts playing automatically as background music.

- You cannot search or skip on a music CD.
- When the slideshow stops, playback of the music CD also stops.
- **MP3**: This function will not operate.

Slideshow settings

In step 2 in "Start Slideshow" above,

- 1 Press [**▲**, **▼**] to select "Slideshow Settings" and press [**OK**].
- 2 To change the display interval

Press [**▲**, **▼**] to select "Display Interval" and press [**◀**, **▶**] to select the interval ("Long", "Normal" or "Short").

• When a still picture with large number of pixels is played, the display interval may become longer. Even if the setting is changed, the display interval may not become shorter.

To set display method

Press [**▲**, **▼**] to select "Transition Effect" and press [**◀**, **▶**] to select "Random" or "Fade".

"Random": The transition effects are changed in a random sequence.

"Fade": The image is displayed while fading in and switches to next image after fading out.

To repeat slideshow

Press [**▲**, **▼**] to select "Repeat Play" and press [**◀**, **▶**] to select "On" or "Off".

- 3 Press [**▲**, **▼**, **◀**, **▶**] to select "Set" and press [**OK**].

Rotate

- 1 While playing (except for slideshows) Press [**SUB MENU**].
- 2 Press [**▲**, **▼**] to select "Rotate Right" or "Rotate Left" and press [**OK**].

• The rotation information will be stored until the unit is turned off or the media is removed.

Zoom out

This function is only available for small-sized still pictures.

- 1 While playing (except for slideshows) Press [**SUB MENU**].
- 2 Press [**▲**, **▼**] to select "Zoom out" and press [**OK**].

• To cancel "Zoom out", press [**▲**, **▼**] to select "Zoom in" in step 2 and press [**OK**].

• The zoom-out information will not be stored.

To select the still pictures in another folder

BD-RE, DVD-RAM

To switch to another higher folder

(Only if there is a multiple number of higher folders recognizable)

- 1 While the "Album View" screen is displayed Press [**SUB MENU**].
- 2 Press [**▲**, **▼**] to select "Select Root folder" and press [**OK**].
- 3 Press [**◀**, **▶**] to select the higher folder and press [**OK**].

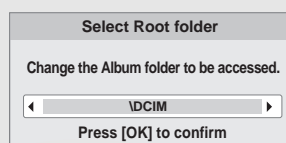

CD-R/RW

- 1 While the "Picture View" screen is displayed Press [**SUB MENU**].
- 2 Press [**▲**, **▼**] to select "Select Folder" and press [**OK**].
- 3 Press [**▲**, **▼**] to select a folder and press [**OK**].

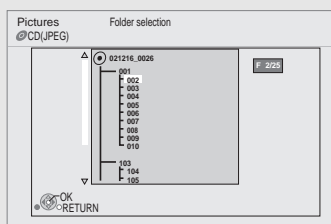

To show the picture properties

While playing

Press [**STATUS**] twice.

e.g. JPEG on DVD-RAM

Shooting date



To exit, press [**STATUS**].

Playing DivX videos DivX BD55

You can play DVD-R, DVD-R DL and CD-R/CD-RW discs which contain DivX video contents that have been recorded on a personal computer.

- Because DivX format can use many different codecs, there is no guarantee that all DivX files will play. (⇒ 35, "About MP3/JPEG/DivX files")

1 Insert a disc. (⇒ 19)

- If a disc containing data in different file formats is inserted, the file selection menu may be displayed. Press [▲, ▼] to select "DivX" and press [OK].

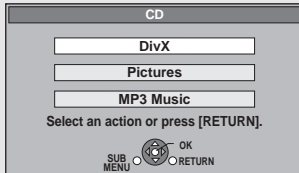

2 Press [▲, ▼] to select the title and press [OK].

Play starts on the selected title.

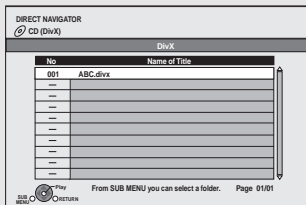

- The picture sizes set for recording may prevent the unit from showing pictures in the proper aspect. You may be able to adjust the aspect through the TV.
- Successive play is not possible.
- You can use search and skip functions. (⇒ 19)
- Press [◀◀, ▶▶] to show other pages.

CD-R/RW

To switch from other menus to DivX menu

(If a disc contains data in different file formats)

- 1) Press [FUNCTIONS].
- 2) Press [▲, ▼] to select "Menu" and press [OK].
- 3) Press [▲, ▼] to select "DivX" and press [OK].

Playing a title in another folder

- 1 While the "DIRECT NAVIGATOR" is displayed Press [SUB MENU].
- 2 Press [▲, ▼] to select "Select Folder" and press [OK].
- 3 Press [▲, ▼] to select a folder and press [OK].

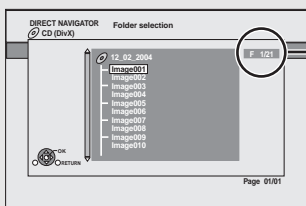

Selected folder No. / Total folders
If the folder has no title, "—" is displayed as folder number.

- You cannot select folders that contain no compatible files.

To return to the previous screen

Press [RETURN].

Regarding DivX VOD content

DivX Video-on-Demand (VOD) content is encrypted for copyright protection. In order to play DivX VOD content on this unit, you first need to register the unit.

Follow the on line instructions for purchasing DivX VOD content to enter the unit's registration code and register the unit. For more information about DivX VOD, visit www.divx.com/vod

Display the unit's registration code.

(⇒ 33, "DivX Registration" in "Others")

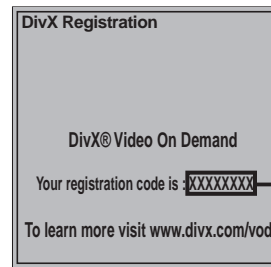

8 alphanumeric characters

- After playing DivX VOD content for the first time, another registration code is then displayed in "DivX Registration". Do not use this registration code to purchase DivX VOD content. If you use this code to purchase DivX VOD content, and then play the content on this unit, you will no longer be able to play any content that you purchased using the previous code.
- If you purchase DivX VOD content using a registration code different from this unit's code, you will not be able to play this content. ("Authorization Error" is displayed.)

Regarding DivX VOD content that can only be played a set number of times

Some DivX VOD content can only be played a set number of times.

When you play this content, the remaining number of plays is displayed. You cannot play this content when the number of remaining plays is zero. ("Rental Expired." is displayed.)

When playing this content

- The number of remaining plays is reduced by one if
 - you press [⏻ BD POWER].
 - you press [■].
 - you press [DIRECT NAVIGATOR].
 - you press [◀◀] or [◀◀, ▶▶] etc. and arrive at another content or the start of the content being played.
 - you press [BD/SD] to change the drive.
- Resume functions do not work.

You can play generally available music CD or MP3 files recorded onto a CD-R/RW.

1 Insert a disc. (⇒ 19)

- If a disc containing data in different file formats is inserted, the file selection menu may be displayed. Press [▲, ▼] to select “MP3 Music” and press [OK].

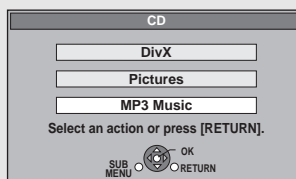

2 Press [▲, ▼] to select the track and press [OK].

Play starts on the selected track.

- **CD** “TR” and the number of that track are displayed on the unit as it plays.

e.g. **CD**

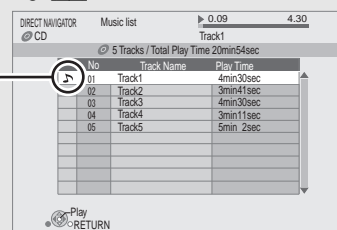

“ ” indicates the track currently playing.

To switch from other menus to MP3 menu

(If a disc contains data in different file formats)

- 1) Press [FUNCTIONS].
- 2) Press [▲, ▼] to select “Menu” and press [OK].
- 3) Press [▲, ▼] to select “MP3 Music” and press [OK].

- You can use search and skip functions. (⇒ 19)
- When the “Screen Saver Function” is set to “On” (⇒ 32), the screen switches to Screen Saver mode if there is no operation for 10 minutes after starting playback. (Playback continues.)

Playing a track in another folder MP3

- 1 While the “Music list” is displayed Press [SUB MENU].
- 2 Press [▲, ▼] to select “Select Folder” and press [OK].
- 3 Press [▲, ▼] to select a folder and press [OK].

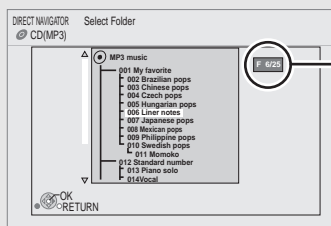

Selected folder No. / Total folders
If the folder has no track, “- -” is displayed as folder number.

- You cannot select folders that contain no compatible tracks.

To return to the previous screen

Press [RETURN].

Displaying subtitles text

You can display subtitles text onto the DivX video disc on this unit. This function has no relation to the subtitles specified in DivX standard specifications and has no clear standard. Depending on the methods used to create the file, the following functions may not work.

- 1 While playing Press [DISPLAY].
- 2 Press [▲, ▼] to select “Disc” and press [▶].
- 3 Press [▲, ▼] to select “Subtitle” and press [▶].
- 4 Press [▲, ▼] to select “On” and press [▶].
- 5 Press [▲, ▼] to select “Text”.

- DivX video files that do not display “Text” do not contain subtitles text. Subtitles text cannot be displayed.
- If the subtitles text are not displayed correctly, try changing the language settings. (⇒ 30)

To exit the screen

Press [DISPLAY].

Linked operations with the TV (VIERA Link™ “HDAVI Control™”)

What is VIERA Link “HDAVI Control”?

VIERA Link™ is a new name for EZ Sync™.

VIERA Link “HDAVI Control” is a convenient function that offers linked operations of this unit, and a Panasonic TV (VIERA) or amplifier/receiver under “HDAVI Control”.

You can use this function by connecting the equipment with an HDMI cable. See the operating instructions for connected equipment for operational details.

- VIERA Link “HDAVI Control”, based on the control functions provided by HDMI which is an industry standard known as HDMI CEC (Consumer Electronics Control), is a unique function that we have developed and added. As such, its operation with other manufacturers' equipment that supports HDMI CEC cannot be guaranteed.
- **This unit supports “HDAVI Control 3” function.**
“HDAVI Control 3” is the newest standard (current as of December, 2007) for Panasonic's HDAVI Control compatible equipment. This standard is compatible with Panasonic's conventional HDAVI equipment.
- Please refer to individual manuals for other manufacturers' equipment supporting VIERA Link function.

Preparation

- 1) Connect this unit to your TV or amplifier/receiver with an HDMI cable (⇒ 11–12).
- 2) Set “VIERA Link” to “On” (⇒ 32). (The default setting is “On”.)
- 3) Set the “HDAVI Control” operations on the connected equipment (e.g., TV).
 - **When using HDMI2 terminal of VIERA as “HDAVI Control”, set the input channel to HDMI2 on VIERA.**
- 4) Turn on all “HDAVI Control” compatible equipment and select this unit's input channel on the connected TV so that the “HDAVI Control” function works properly.

Also when the connection or settings are changed, repeat this procedure.

Automatic input switching

When the following operations are performed, the television will automatically switch the input channel and display the corresponding action.

- When play starts on the unit
- When an action that uses the display screen is performed (e.g., Direct Navigator screen)

Power on link

When the television is off and the following operations are performed, the television will automatically turn on and display the corresponding action.

- When play starts on the unit
- When an action that uses the display screen is performed (e.g., Direct Navigator screen)

Power off link

All connected equipment compatible with “HDAVI Control”, including this unit, automatically turns off when you switch the television off.

- This unit automatically turns off even during playback or any other operation.

- When [▶] (PLAY) is pressed on this unit for “Automatic input switching” or “Power on link”, the playback image is not immediately displayed on the screen and it may not be possible to watch the contents from where playback started. In this case, press [◀◀] or [◀◀] to go back to where playback started.

Playing music continuously even after turning off power to the television

When the unit is connected to a Panasonic TV (VIERA) that supports HDAVI Control 2 or HDAVI Control 3 and an amplifier/receiver supports VIERA Link, the unit is turned off if the power to the television is turned off, since “Power off link” (⇒ above) operates.

The following operations make it possible to keep the power of the unit on and to play music continuously.

- ① While playing music
Press [SUB MENU].
 - ② Press [▲, ▼] to select “TV Power” and press [OK].
- Sound may be discontinued for several seconds when the power to the television is turned off.
 - If the operation mentioned above is executed while audio is output from the television, the sound may not be output from the amplifier/receiver. It is recommended to set the amplifier/receiver beforehand so that audio will be output from the amplifier/receiver.

Easy control only with VIERA remote control

If you connect this unit to a TV that has "HDAVI Control 2" or "HDAVI Control 3" function with an HDMI cable, you can operate this unit using the following buttons on the TV remote control.

[▲, ▼, ◀, ▶], [OK], [RETURN], [EXIT], [SUB MENU] and colored buttons ([EXIT]: Exit the screen)

Use the remote control for this unit to operate any other buttons (numbered buttons, etc.) that are not listed above.

• Refer to the TV operating instructions for operating TV.

Using the FUNCTIONS menu to operate this unit

By using the TV remote control, you can play media using the FUNCTIONS menu.

1 Press the button for VIERA Link on the remote control.

2 Select the player.

- The FUNCTIONS menu is displayed.

e.g.,



Using the sub menu to operate this unit

By using the TV remote control, you can play discs using the "Control Panel" and display the Top Menu (for BD-Video and DVD-Video) or Pop-up Menu (for BD-Video).

1 Press [SUB MENU].

- This can also be displayed by using the VIERA menu screen.
- You cannot use the sub menu while the Top Menu for BD-Video or DVD-Video is displayed.

2 Select an item, then press [OK].

e.g.,

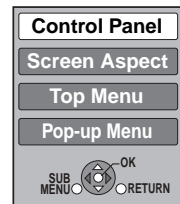

| | |
|---|---|
| Control Panel | Control Panel is displayed. Follow the indications on the screen. |
| Screen Aspect | (⇒ 20) |
| Top Menu BD-V AVCHD DVD-V | Top menu is displayed. |
| Menu DVD-V | Menu is displayed. |
| Pop-up Menu BD-V AVCHD | Pop-up menu is displayed. |
| Rotate Right JPEG | Rotate the still picture. |
| Rotate Left JPEG | |
| Zoom in JPEG | Enlarge or reduce the still picture. |
| Zoom out JPEG | |

When you want to leave the TV on and set only this unit to standby mode

Press [⏻ BD POWER] on this unit's remote control and set to standby mode.

When not using "HDAVI Control"

Set "VIERA Link" in the Setup menu to "Off". (⇒ 32)

Changing settings with the on-screen menu

On-screen menu operations

- 1 Press [DISPLAY].
- 2 Press [▲, ▼] to select the menu and press [▶].
- 3 Press [▲, ▼] to select the item and press [▶].
- 4 Press [▲, ▼] to select the setting.

e.g., BD-Video

| | | | |
|-------|----------------|-----|----------|
| Disc | Signal Type | | |
| Play | Subtitle | Off | PIP 1ENG |
| Video | Subtitle Style | - | Angle - |
| Audio | | | |

Menu Items Settings

- Depending on the condition of the unit (playing, stopped, etc.) and disc contents, there may be some items that you cannot select or change.

- Some items can be changed by pressing [OK].

To exit the on-screen menu
Press [DISPLAY].

What you can change with the on-screen menu

| Menus | Items | Settings and details |
|-------|----------------|---|
| Disc | Signal Type | BD-V <ul style="list-style-type: none"> • Primary Video Video: The original video recording method appears. (⇒ below, Video recording method) Soundtrack: Select the type of audio or language. (⇒ below, Language, Audio attribute) • Secondary Video Video: Select on/off of images. The original video recording method appears. (⇒ below, Video recording method) Soundtrack: Select on/off of audio and the language. (⇒ below, Language, Audio attribute) |
| | Video | AVCHD The original video recording method appears. (⇒ below, Video recording method) |
| | Soundtrack | AVCHD DVD-V Select the type of audio or language. (⇒ below, Language, Audio attribute) DVD-VR The audio attributes appear. (⇒ below, Audio attribute) DivX Select the soundtrack number. • Soundtrack numbers are displayed even when there is only one audio type. |
| | Subtitle | BD-V AVCHD DVD-V Turn the subtitle on/off and select the language. (⇒ below, Language) DVD-VR (Only discs that contain subtitle on/off information) Turn the subtitle on/off. DivX Turn the subtitle on/off and select "Text" or the subtitle number. • Subtitle number is displayed even if there are not multiple subtitles. |
| | Subtitle Style | BD-V Select the subtitle style. |
| | Audio channel | DVD-VR DivX (⇒ 20, Changing audio during play) |
| | Angle | BD-V DVD-V Select the number of the angle. |

Some items may be changed only on the disc specific menu. (⇒ 19)

Language

| | | |
|----------------|-----------------|----------------|
| ENG: English | DAN: Danish | THA: Thai |
| FRA: French | POR: Portuguese | POL: Polish |
| DEU: German | RUS: Russian | CES: Czech |
| ITA: Italian | JPN: Japanese | SLK: Slovak |
| ESP: Spanish | CHI: Chinese | HUN: Hungarian |
| NLD: Dutch | KOR: Korean | FIN: Finnish |
| SVE: Swedish | MAL: Malay | *: Others |
| NOR: Norwegian | VIE: Vietnamese | |

Audio attribute

| | |
|--|--------------------|
| LPCM/□□Digital/□□Digital+ □□TrueHD/DTS/DTS 96/DTS-HD HI RES/DTS-HD MSTR/DTS-HD LBR | Signal type |
| ch (channel) | Number of channels |
| k (kHz) | Sampling frequency |
| b (bit) | Number of bits |

Video recording method

| | |
|--------------------|---|
| MPEG-2 | This is a standard for compressing and decompressing color motion pictures efficiently. This compression method is used for DVDs, etc. |
| MPEG-4 AVC VC-1 | These are standards for compressing and decompressing color motion pictures more efficiently than MPEG-2 and used for Blu-ray Discs, etc. |

| Menus | Items | Settings and details |
|-------------------|--|--|
| Play | Repeat Play | <p>(Only when the elapsed time is being displayed on the unit's display.) Selects the item which you want to repeat. The items displayed differ depending on the type of disc.</p> <ul style="list-style-type: none"> ● All tracks All tracks ● Chapter Chapter ● Playlists Playlist ● Title Title ● One track Track ● Off <p>Select "Off" to cancel.</p> |
| | Random | <p>CD MP3</p> <p>While playing, press [▲, ▼] to select "On". Random playback starts from the next track.</p> <ul style="list-style-type: none"> ● On ● Off |
| Video | Picture | <p>BD-V AVCHD DVD-VR DVD-V DivX</p> <p>Select the picture quality mode during play.</p> <ul style="list-style-type: none"> ● Normal: Default setting ● Soft: Soft picture with smoother video ● Fine: Details are sharper ● Cinema: Mellows movies, enhances detail in dark scenes. ● User: You can make further adjustments. (⇒ below) <p>① Press [▶] to select "Picture Adjustment" and press [OK]. ② Select the item using [▲, ▼] and adjust it with [◀, ▶].</p> <p>Contrast: Increases the contrast between light and dark parts of the picture (-7 to +7).</p> <p>Brightness: Brightens the picture (0 to +15).</p> <p>Sharpness: Adjusts the sharpness of the edges of the horizontal lines (-6 to +6).</p> <p>Color: Adjusts the shade of the picture's color (-7 to +7).</p> <p>Gamma: Adjusts the brightness of dark portions of the screen (0 to +5).</p> <p>3D NR: Reduces the rough noise in the background to give a greater feeling of depth (0 to +4). When "24p Output" is set to "On", this function may not operate. (⇒ 32)</p> <p>Integrated NR: Smooths block noise and reduces the smudging that appears around contrasting sections of the picture (0 to +3).</p> |
| | Progressive | <p>Select the method of conversion for progressive output to suit the type of material being played (⇒ 46, Film and video).</p> <ul style="list-style-type: none"> ● Auto: Automatically detects the film and video content, and appropriately converts it. ● Video: Select when using "Auto", and the content is distorted. |
| | 24p DVD-V | <ul style="list-style-type: none"> ● On ● Off <p>Only when you have selected "On" in "24p Output" (⇒ 32)</p> |
| Audio | Sound Effects*1,2 | <ul style="list-style-type: none"> ● Off |
| | | <p>Re-master (⇒ 20)</p> <ul style="list-style-type: none"> ● Re-master 1 ● Re-master 2 ● Re-master 3 |
| | <p>V. Surround</p> <p>BD-V AVCHD DVD-VR DVD-V DivX (2 channels or more only)</p> <p>Enjoy a surround-like effect if you are using two front speakers only. – Turn V. Surround off if it causes distortion. – Do not use in combination with surround effects on other equipment. – V. Surround does not work for bilingual recordings.</p> <ul style="list-style-type: none"> ● V. Surround 1 ● V. Surround 2 <p>Night Surround</p> <p>To enjoy a movie with powerful sound even when the volume is kept low at night, the audio is set in such a way that it can be heard easily.</p> <ul style="list-style-type: none"> ● Night Surround | |
| Dialog Enhancer*1 | <p>BD-V AVCHD DVD-VR DVD-V (3 channels or more only, including a center channel)</p> <p>The volume of the center channel is raised to make dialog easier to hear.</p> <ul style="list-style-type: none"> ● On ● Off | |

*1 This function is effective for audio from the HDMI terminal or the DIGITAL AUDIO OUT terminal only when "Dolby D/Dolby D +/Dolby TrueHD" or "DTS/DTS-HD" is set to "PCM". (However, in this case, audio is output as 2ch from the DIGITAL AUDIO OUT terminal.)

*2 Not every function can be set individually.

Changing the unit's settings

Change the unit's settings if necessary. The settings remain intact even if you switch the unit to standby.

Setup menu operations

- 1 While stopped
Press [SETUP].
- 2 Press [▲, ▼] to select the menu and press [OK].
- 3 Press [▲, ▼] to select the item and press [OK].
If there are any other items, repeat these steps.
- 4 Press [▲, ▼, ◀, ▶] to select the option and press [OK].

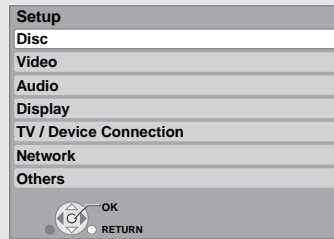

• There may be differences in operation methods. If this happens, follow the on-screen instructions for the operation.

To return to the previous screen

Press [RETURN].

To exit the screen

Press [SETUP].

Summary of settings

Underlined items are the factory presets.

“Disc”

| | | |
|--|---|---|
| DVD-Video Ratings Set a ratings level to limit DVD-Video play. | Follow the on-screen instructions. Enter a 4-digit password with the numbered buttons when the password screen is shown. It will be the common password for both “DVD-Video Ratings” and “BD-Video Ratings”. • Do not forget your password. | <ul style="list-style-type: none"> • <u>8 No Limit</u>: All DVD-Video can be played. • 1 to 7: Prohibits play of DVD-Video with corresponding ratings recorded on them. • 0 Lock All: Prohibits play of all DVD-Video. • <u>Unlock Player</u> • Change Password • <u>Change Level</u> • Temporary Unlock |
| BD-Video Ratings Set an age limit of BD-Video play. | <ul style="list-style-type: none"> • <u>No Limit</u>: All BD-Video can be played. • 0 to 254 year(s): Prohibits play of BD-Video with corresponding ratings recorded on them. • <u>Unlock Player</u> • Change Password • <u>Change Level</u> • Temporary Unlock | |
| Audio Language | Choose the language for audio, subtitle and disc menus. BD-V DVD-V | <ul style="list-style-type: none"> • <u>English</u> • French • Spanish • Original: The original language of each disc will be selected. • Other ***** |
| Subtitle Language | <ul style="list-style-type: none"> • Some discs start in a certain language despite any changes you make here. • When the selected language is not available on the disc, the default language is played. There are discs where you can only switch the language from the menu screen. (⇒ 19) | <ul style="list-style-type: none"> • <u>Automatic</u>: If the language selected for “Audio Language” is not available, subtitles of that language will automatically appear if available on that disc. • English • French • Spanish • Other ***** |
| Menu Language | <ul style="list-style-type: none"> • Enter a code (⇒ below) with the numbered buttons when you select “Other *****”. | <ul style="list-style-type: none"> • <u>English</u> • French • Spanish • Other ***** |
| BD-Live Internet Access BD-V (⇒ 21) You can restrict Internet access when BD-Live functions are used. | | <ul style="list-style-type: none"> • <u>Allow (ALL)</u>: Internet access is permitted for all BD-Live contents. • <u>Allow (Limited)</u>: Internet access is permitted only for BD-Live contents which have content owner certificates. Internet access is prohibited for all BD-Live contents without a certificate. • <u>Prohibit</u>: Internet access is prohibited for all BD-Live contents. |
| DivX Subtitle Text DivX Select a suitable item according to the language used for DivX subtitles text (⇒ 25). • This item is displayed only when pressing [SETUP] after playing back a file. | | <ul style="list-style-type: none"> • <u>Latin1</u> English, German, Spanish, etc. • <u>Latin2</u> Polish, Czech, Hungarian, etc. • <u>Cyrillic</u> Russian, etc. |

Language code list Enter the code with the numbered buttons.

| | | | | | |
|-----------------------|-------------------|------------------------|----------------------|----------------------|------------------|
| Abkhazian: 6566 | Catalan: 6765 | Gujarati: 7185 | Lingala: 7678 | Rhaeto-Romance: 8277 | Tamil: 8465 |
| Afar: 6565 | Chinese: 9072 | Hausa: 7265 | Lithuanian: 7684 | Romanian: 8279 | Tatar: 8484 |
| Afrikaans: 6570 | Corsican: 6779 | Hebrew: 7387 | Macedonian: 7775 | Russian: 8285 | Telugu: 8469 |
| Albanian: 8381 | Croatian: 7282 | Hindi: 7273 | Malagasy: 7771 | Samoan: 8377 | Thai: 8472 |
| Amharic: 6577 | Czech: 6783 | Hungarian: 7285 | Malay: 7783 | Sanskrit: 8365 | Tibetan: 6679 |
| Arabic: 6582 | Danish: 6865 | Icelandic: 7383 | Malayalam: 7776 | Scots Gaelic: 7168 | Tigrinya: 8473 |
| Armenian: 7289 | Dutch: 7876 | Indonesian: 7378 | Maltese: 7784 | Serbian: 8382 | Tonga: 8479 |
| Assamese: 6583 | English: 6978 | Interlingua: 7365 | Maori: 7773 | Serbo-Croatian: 8372 | Turkish: 8482 |
| Aymara: 6589 | Esperanto: 6979 | Irish: 7165 | Marathi: 7782 | Shona: 8378 | Turkmen: 8475 |
| Azerbaijani: 6590 | Estonian: 6984 | Italian: 7384 | Moldavian: 7779 | Sindhi: 8368 | Twì: 8487 |
| Bashkir: 6665 | Faroese: 7079 | Japanese: 7465 | Mongolian: 7778 | Singhalese: 8373 | Ukrainian: 8575 |
| Basque: 6985 | Fiji: 7074 | Javanese: 7487 | Nauru: 7865 | Slovak: 8375 | Urdu: 8582 |
| Bengali, Bangla: 6678 | Finnish: 7073 | Kannada: 7578 | Nepali: 7869 | Slovenian: 8376 | Uzbek: 8590 |
| Bhutani: 6890 | French: 7082 | Kashmiri: 7583 | Norwegian: 7879 | Somali: 8379 | Vietnamese: 8673 |
| Bihari: 6672 | Frisian: 7089 | Kazakh: 7575 | Oriya: 7982 | Spanish: 6983 | Volapük: 8679 |
| Breton: 6682 | Galician: 7176 | Kirghiz: 7589 | Pashto, Pushto: 8083 | Sundanese: 8385 | Welsh: 6789 |
| Bulgarian: 6671 | Georgian: 7565 | Korean: 7579 | Persian: 7065 | Swahili: 8387 | Wolof: 8779 |
| Burmese: 7789 | German: 6869 | Kurdish: 7585 | Polish: 8076 | Swedish: 8386 | Xhosa: 8872 |
| Byelorussian: 6669 | Greek: 6976 | Laotian: 7679 | Portuguese: 8084 | Tagalog: 8476 | Yiddish: 7473 |
| Cambodian: 7577 | Greenlandic: 7576 | Latin: 7665 | Punjabi: 8065 | Tajik: 8471 | Yoruba: 8979 |
| | Guarani: 7178 | Latvian, Lettish: 7686 | Quechua: 8185 | | Zulu: 9085 |

To select these options, perform steps 1–4 (⇒ 30)

“Video”

| | |
|--|--|
| <p>Still Mode (paused video) BD-V AVCHD DVD-V Select the type of picture shown when you pause playback (⇒ 46, Frames and fields).</p> | <ul style="list-style-type: none"> ● Auto ● Field: Select if jittering occurs when “Auto” is selected. (The picture is coarser.) ● Frame: Select if small text or fine patterns cannot be seen clearly when “Auto” is selected. (The picture is clearer and finer.) |
| <p>Seamless Play DVD-VR Select the play mode between playlist chapter segments and partially deleted titles.</p> | <ul style="list-style-type: none"> ● On: The chapters in playlists are played seamlessly. This does not work while searching or when there are several audio types included on the playlist. Additionally, the positioning of chapter segments may change slightly. ● Off: The points where chapters in playlists change are played accurately, but the picture may freeze for a moment. |
| <p>Black Level Control Select lighter or darker for adjusting the black level control to the desired setting for picture enhancement.</p> | <ul style="list-style-type: none"> ● Lighter: When video is output from VIDEO OUT terminal. ● Darker: When video is output from COMPONENT VIDEO OUT terminal. |

“Audio”

| | |
|--|---|
| <p>Dynamic Range Compression BD-V AVCHD DVD-V DivX (Dolby Digital, Dolby Digital Plus and Dolby TrueHD only) Change the dynamic range (⇒ 46) for late night viewing.</p> | <ul style="list-style-type: none"> ● On ● Off ● Auto: Effective only when Dolby TrueHD is played. |
| <p>Digital Audio Output (⇒ 8) ● Press [OK] to show the following settings.</p> | |
| <p>Dolby D/Dolby D +/ Dolby TrueHD DTS/DTS-HD</p> <p>Select whether Dolby Digital, Dolby Digital Plus, Dolby TrueHD, DTS Digital Surround, DTS-HD High Resolution Audio or DTS-HD Master Audio is output in “Bitstream” or “PCM” format.</p> <ul style="list-style-type: none"> ● Not making the proper settings may result in noise. ● If the unit is connected with the HDMI AV OUT terminal, the specifications of the connected equipment take preference over this unit and audio selected in these items may not be output (e.g., when a television is connected, the HDMI audio output of this unit is limited to down-mixed 2ch.) | <ul style="list-style-type: none"> ● Bitstream: Select “Bitstream” when the connected equipment can decode the respective audio format. – Connect equipment supporting HDMI (High Bit rate Audio) and use a High Speed HDMI Cable in order to output high bit rate audio such as Dolby Digital Plus, Dolby TrueHD, DTS-HD High Resolution Audio or DTS-HD Master Audio. ● PCM: Select “PCM” when the connected equipment cannot decode the respective audio format. <p>Refer to the operating instructions for connected devices to verify whether or not they can decode each of the audio formats.</p> |
| <p>BD-Video Secondary Audio BD-V Turn on/off the clicking sound on the menu and audio with secondary video in picture-in-picture mode. (⇒ 21)</p> | <ul style="list-style-type: none"> ● On: The primary audio and secondary audio are mixed and output. The sampling frequency is converted to 48 kHz. ● Off: The clicking sound on the menu and secondary audio are not output. |
| <p>PCM Down Conversion Select how to output audio with a sampling frequency of 96 kHz or more.</p> <ul style="list-style-type: none"> ● Signals are converted to 48 kHz despite the settings across in the following cases: <ul style="list-style-type: none"> – when the signals have a sampling frequency of over 96 kHz – when the disc has copy protection – when “BD-Video Secondary Audio” is set to “On” | <ul style="list-style-type: none"> ● On: Signals are converted to 48 kHz. (Choose when the connected equipment cannot process signals with sampling frequency of 96 kHz.) ● Off: Signals are output as 96 kHz. (Choose when the connected equipment can process signals with sampling frequency of 96 kHz.) |
| <p>Downmix Switch the downmix system for playing back multi-channel surround sound.</p> <ul style="list-style-type: none"> ● When “Dolby D/Dolby D +/Dolby TrueHD” or “DTS/DTS-HD” is set to “Bitstream”, there are no downmix effects for the outputted audio. ● The audio will be outputted in “Stereo” in the following cases. <ul style="list-style-type: none"> – AVCHD playback – Playback of clicking sound on the menu and audio with secondary video in picture-in-picture mode | <ul style="list-style-type: none"> ● Stereo: When connected to equipment that does not support the virtual surround function. ● Surround encoded: When connected to equipment that supports the virtual surround function (Dolby Pro Logic, DTS Neo: 6, etc.). |

Changing the unit's settings

To select these options, perform steps ①–④ (⇒ 30)
Underlined items are the factory presets.

“Display”

| | |
|--|--|
| Status Messages Choose whether to show status messages automatically. | <ul style="list-style-type: none"> ● <u>Automatic</u> ● Off |
| On-screen Language Choose the language for these menus and on-screen messages. | <ul style="list-style-type: none"> ● <u>English</u> ● Français ● Español |
| Screen Saver Function This is to prevent burn-in on the screen. ● When this is set to “On”, the masked-off area on the screen becomes gray. [Only when connecting with an HDMI cable or a component video cable and “HDMI Resolution” (⇒ below) is set to any other mode than “480p”, or “Component Video Resolution” (⇒ below) is set to “720p” or “1080i”] | <ul style="list-style-type: none"> ● On: If there is no operation for 10 minutes or more, the displayed screen switches to the other states automatically. <ul style="list-style-type: none"> – When the Direct Navigator or FUNCTIONS menu is displayed, the display returns to the screen saver mode. – When CD or MP3 is played, the display returns to the screen saver mode. (Playback continues.) – When still pictures are shown (except for slideshows), the display returns to the Direct Navigator screen. ● Off |
| FL Display Changes the brightness of the unit's display. | <ul style="list-style-type: none"> ● <u>Bright</u> ● Dim: The display is dimmed. ● Auto: The display is dimmed during playback and bright except playback. |
| SD Card LED Control BD55 Set the lighting method for the lamp on the SD card slot. | <ul style="list-style-type: none"> ● <u>On</u> ● SD inserted: When this unit is turned on and SD card is inserted, the lamp is lighted. ● Off |
| License | Information about the software used by this unit is displayed. |

“TV / Device Connection”

| | |
|--|--|
| TV Aspect Set to match the type of television connected. | <p>When connected to a 4:3 aspect television:</p> <ul style="list-style-type: none"> ● 4:3 Pan & Scan: Video recorded for a widescreen is played as Pan & Scan (unless prohibited by the producer of the disc). When playing BD-Video, video is output as “4:3 Letterbox”. ● 4:3 Letterbox: Video recorded for a widescreen is played in the letterbox style. <p>When connected to a 16:9 widescreen television:</p> <ul style="list-style-type: none"> ● 16:9: Video recorded for 4:3 aspect screen is displayed as a 4:3 ratio image in the center of the screen. ● 16:9 Full: Video recorded for 4:3 aspect screen is displayed as a horizontally stretched 16:9 image. |
| HDMI Connection ● Press [OK] to show the following settings. | |
| HDMI Video Mode Select “On” when video is output from HDMI AV OUT terminal. | <ul style="list-style-type: none"> ● On: Images are output from the HDMI terminal in the resolution set in “HDMI Resolution”. Video from COMPONENT VIDEO OUT terminal is output as “480i”. ● Off: Images are output in the resolution set in “Component Video Resolution”. |
| HDMI Resolution* The items supported by the connected devices are indicated on the screen as “*”. When any item without “*” is selected, the images may be distorted. | <ul style="list-style-type: none"> ● <u>Auto</u>: Automatically selects the output resolution best suited to the connected television (1080p, 1080i, 720p or 480p). <ul style="list-style-type: none"> ● 720p ● 1080p ● 480p ● 1080i <p>– When the unit is connected to an amplifier/receiver that does not support the resolution set on the unit, the video cannot be output properly. In this case, use the HDMI cable to connect the unit to the TV and then connect the unit to the amplifier/receiver using a cable other than HDMI.</p> <p>– To enjoy high definition video up-converted to 1080p, you need to connect the unit directly to 1080p compatible HDTV (High Definition Television). If this unit is connected to an HDTV through other equipment, it must also be 1080p compatible.</p> |
| 24p Output BD-V DVD-V When this unit is connected to a TV supporting 1080/24p output via an HDMI cable, this unit displays each frame at 1/24 second intervals – the same interval originally shot with the film camera. ● When playing DVD-Video, set to “On” and then set “24p” in “Video” (⇒ 29) to “On” | <ul style="list-style-type: none"> ● On: Images in 24p are output in 24p as they are. However, <ul style="list-style-type: none"> – when video is being output at 24 frames, images from any other terminal than the HDMI terminal may not be output properly. – BD-V: when images other than 24p are played, images are output at 60p. ● Off |
| HDMI RGB Output Range Effective when connected to a device that only supports RGB output. | <ul style="list-style-type: none"> ● <u>Standard</u>: The video is output as it is. ● Enhanced: When the black and white contrast of a video is low, the signal is enhanced to reproduce clear video. |
| HDMI Audio Output This setting selects whether or not to output audio from HDMI. | <ul style="list-style-type: none"> ● On: ● Off: When the TV is connected to this unit using an HDMI cable, and this unit is also connected to other devices, such as an amplifier/receiver using an optical digital audio cable or a coaxial cable BD55. |
| VIERA Link Set to use “HDAVI Control” function when connected with an HDMI cable to a device that supports “HDAVI Control”. | <ul style="list-style-type: none"> ● On: ● Off: Select when you do not want to use “HDAVI Control”. |
| Component Video Resolution* This sets the video output resolution when using the component video terminal. | <ul style="list-style-type: none"> ● <u>480i</u> ● 480p ● 720p ● 1080i <p>Even if you select “720p” or “1080i”, the video output resolution is restricted to “480p” when images of DVD-Video discs are output from the COMPONENT VIDEO OUT terminals.</p> |
| Analog Audio Output BD55 When connected with AUDIO OUT terminals, you can set the unit to output the best possible sound for your speakers. | <ul style="list-style-type: none"> ● <u>2ch (Downmix) + 5.1ch</u>: When connecting to 2ch AUDIO OUT or 5.1ch AUDIO OUT. (⇒ 34) ● 7.1ch: When connecting to 7.1ch AUDIO OUT. (⇒ 34) |

* In this unit, a P4HD (⇒ 47) video processor is used to provide video of optimal resolution to the connected TV.

To select these options, perform steps ①–④ (⇒ 30)

“Network”

IP Address/DNS Settings (⇒ 17)

• Press [OK] to show the following settings.

| | | |
|---|---------------------------------|-----------------------|
| Connection Test | ----- | |
| IP Address Auto Configuration (DHCP) | • On | • Off |
| IP Address | ----- . ----- . ----- . ----- | |
| Subnet Mask | ----- . ----- . ----- . ----- | |
| Default Gateway | ----- . ----- . ----- . ----- | |
| DNS Auto Configuration (DHCP) | • On | • Off |
| Primary DNS | ----- . ----- . ----- . ----- | |
| Secondary DNS | ----- . ----- . ----- . ----- | |
| Auto Detect Connection Speed | • On | • Off |
| Connection Speed Setting | • 10BASE Half Duplex | • 10BASE Full Duplex |
| This is enabled only when “Auto Detect Connection Speed” is turned “Off”. | • 100BASE Half Duplex | • 100BASE Full Duplex |
| Proxy Server Settings (⇒ 18) | | |
| • Press [OK] to show the following settings. | | |
| Reset to factory preset | • Yes | • No |
| Proxy Address | (The initial setting is blank.) | |
| Proxy Port Number | (The initial setting is “0”.) | |

“Others”

| | | | |
|---|---------------------------------------|--------------|--------------|
| Off Timer | • 2 Hours | • 6 Hours | • Off |
| Select how long the unit remains on when it is not being used. | | | |
| Remote Control Code | • Set Code 1 | • Set Code 2 | • Set Code 3 |
| Easy Setting | • Yes | • No | |
| You can execute basic settings (“On-screen Language”, “TV Aspect”, “Analog Audio Output” [BD55]). | | | |
| Restore Default Settings | • Yes | • No | |
| This returns all values in the Setup menu and the on-screen menu, except for “Remote Control Code”, “On-screen Language”, “IP Address/DNS Settings”, “Proxy Server Settings”, “DVD-Video Ratings” and “BD-Video Ratings” to the default settings. | | | |
| DivX Registration [DivX] (⇒ 24) | | | |
| You need this registration code to purchase and play DivX Video-on-Demand (VOD) content. | | | |
| Firmware Update (⇒ 14) | | | |
| • Press [OK] to show the following settings. | | | |
| Automatic Update Check | • On | • Off | |
| When this equipment remains connected to the Internet, it will check for the latest firmware version when it is turned on and you can update it if necessary. | | | |
| Update Now | You can update the firmware manually. | | |

When other Panasonic products respond to this remote control

Change the remote control code on the main unit and the remote control (the two must match) if you place other Panasonic products close together.

- ① Press [SETUP].
- ② Press [▲, ▼] to select “Others” and press [OK].
- ③ Press [▲, ▼] to select “Remote Control Code” and press [OK].
- ④ Press [▲, ▼] to select the code (1, 2, or 3) and press [OK].
- ⑤ To change the code on the remote control
While pressing [OK], press and hold the numbered button ([1], [2] or [3]) for more than 5 seconds.
- ⑥ Press [OK].

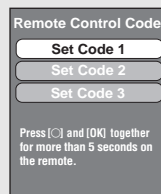

When the following indicator appears on the unit’s display and you are unable to operate the unit



The unit’s remote control code
Press and hold [OK] and the indicated number button at the same time for more than 5 seconds.

Changing the unit's settings

Changing the speaker setting to suit your speakers BD55

When connecting to an amplifier/receiver to enjoy multi-channel surround sound, use the following settings on this unit if they cannot be set on the amplifier/receiver.

The settings are effective when connecting to analog 7.1 ch/5.1ch AUDIO OUT terminal.

Preparation

- Set "Analog Audio Output" to "2ch (Downmix) + 5.1ch" or "7.1ch".
(⇒ 32)
A message is displayed.
- Press [OK].

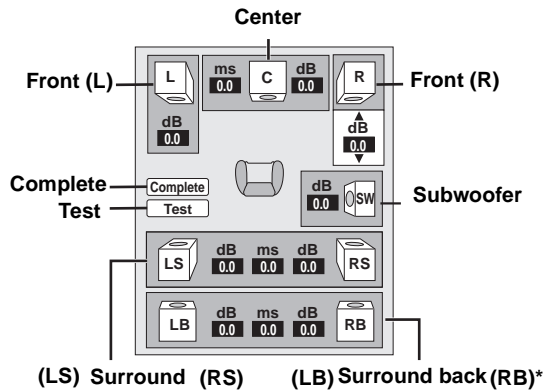

(LS) Surround (RS) (LB) Surround back (RB)*

* Surround back channel is enabled only when setting "Analog Audio Output" to "7.1ch".

Speaker presence and size ()

Set all the connected speakers individually.

- Press [▲, ▼, ◀, ▶] to select the speaker icon and press [OK].
- Press [▲, ▼] to select the setting and press [OK].

Icon examples:

Surround speaker (LS)



- Large:** Select when the speaker supports low-frequency (under 100 Hz) reproduction.
- Small:** Select when the speaker does not support low-frequency reproduction.

In order to make an ideal listening environment, settings of speaker sizes may be automatically adjusted.

For example, if the subwoofer is set to "No", the front speakers will automatically be set to "Large". (In this case, we recommend connecting a speaker that can reproduce bass below 100 Hz.)

Delay time ()

For optimum listening with 7.1/5.1-channel sound, all the speakers, except for the subwoofer, should be the same distance from the seating position.

If you have to place the center, surround and surround back speakers closer to the seating position, adjust the delay time to make up for the difference.

If either distance (A) or (C) is less than (B) (⇒ below), find the difference in the relevant table and change to the recommended setting.

- Press [▲, ▼, ◀, ▶] to select the delay time box () and press [OK].
- Press [▲, ▼] to select the setting and press [OK].

5.1ch speaker connection

7.1ch speaker connection

Approximate room dimensions

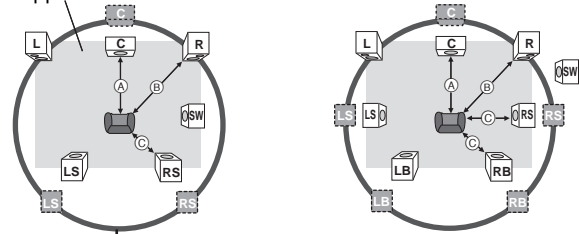

Circle of constant primary listening distance

: Actual speaker position

: Ideal speaker position

(A) (B) (C) : Primary listening distance

(A) Center speaker

| Difference | Setting |
|------------------------------|---------|
| Approx. 34 cm (1 ft. 1 in.) | 1.0 ms |
| Approx. 68 cm (2 ft. 2 in.) | 2.0 ms |
| Approx. 102 cm (3 ft. 4 in.) | 3.0 ms |
| Approx. 136 cm (4 ft. 5 in.) | 4.0 ms |
| Approx. 170 cm (5 ft. 6 in.) | 5.0 ms |

(C) Surround/Surround back speakers

| Difference | Setting |
|-------------------------------|---------|
| Approx. 170 cm (5 ft. 6 in.) | 5.0 ms |
| Approx. 340 cm (11 ft. 1 in.) | 10.0 ms |
| Approx. 510 cm (16 ft. 8 in.) | 15.0 ms |

Channel balance ()

- Select "Test" and press [OK].
A test signal is output.

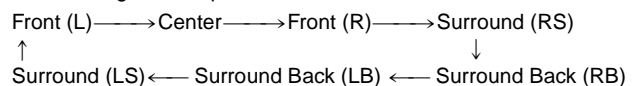

- While listening to the test signal, press [▲, ▼] to adjust the volume of each speaker
Front speakers: 0.0 to -6.0 dB
Center and surround speakers: 0.0 to -12.0 dB
• You cannot adjust the volume of surround back speakers.
- Press [OK].
The test signal stops.
• No signal is output for the subwoofer. To adjust its volume, play something, then return to this screen to adjust to suit your taste.
- Press [OK].

About MP3/JPEG/DivX files

MP3

| | |
|-------------------------|---|
| File format | MP3 |
| Playable media | CD-R*1, CD-RW*1 |
| Extension | Files must have the extension ".mp3" or ".MP3". |
| Compression rate | 32 kbps to 320 kbps |
| Sampling rate | 44.1 kHz/48 kHz |
| Reference | ID3 tags: version 1, 2.2, 2.3, 2.4 ID3 is a tag embedded in MP3 track to provide information about the track. This unit supports the versions listed above but only titles and the names of artists can be displayed. ● If there is a large amount of still picture data etc. within a MP3 file, play may not be possible. |

JPEG

| | |
|---------------------------|--|
| File format | JPEG |
| Playable media | CD-R*1, CD-RW*1, DVD-RAM*2, BD-RE*3, SD card |
| Extension | Files must have the extension ".jpg" or ".JPG". |
| Picture resolution | between 34×34 and 8192×8192 pixels (sub sampling is 4:2:2 or 4:2:0) |
| Reference | JPEG conforming DCF*4 is supported. Thawing Time: approx. 2 sec. (7M pixels) ● MOTION JPEG and Progressive JPEG is not supported |

DivX BD55

| | |
|---------------------------|--|
| File format | DivX |
| Playable media | CD-R*1, CD-RW*1, DVD-R*1,*5, DVD-R DL*1,*5 |
| Extension | Files must have the extension ".DIVX", ".divx", ".AVI" or ".avi". |
| Picture resolution | between 32×32 and 720×576 pixels |
| Reference | ● Plays all versions of DivX video (including DivX 6) with standard playback of DivX media files. Certified to the DivX Home Theater Profile. Video – Number of stream: Up to 1 – Codec: DIV3, DIV4, DIVX, DV50, DIV6 – FPS (Frame Per Second): Up to 30 fps Audio – Number of stream: Up to 8 – Format: MP3, MPEG, AC3 – Multi channel: AC3 is possible. MPEG multi is 2 ch conversion. ● GMC (Global Motion Compensation) is not supported. ● Picture may stop if the DivX files are greater than 2 GB. |

Subtitles text file of DivX BD55

| | |
|-----------------------|--|
| File format | Subtitles text file of DivX |
| Playable media | CD-R*1, CD-RW*1, DVD-R*1,*5, DVD-R DL*1,*5 |
| File format | MicroDVD, SubRip, or TMLayer |
| Extension | Files must have the extension ".SRT", ".srt", ".SUB", ".sub", ".TXT", or ".txt" |
| Reference | ● The DivX video file and subtitles text file are inside the same folder, and the file names are the same except for the file extensions. ● If there are more than one subtitles text files inside the same folder, they are displayed in the following order of priority: ".srt", ".sub", ".txt". ● In the following situations, the subtitles cannot be displayed as recorded. Furthermore, depending on the methods used to create the file or the state of the recording, only parts of the subtitles may be displayed, or the subtitles may not be displayed at all. – When special text or characters are included in the subtitles text. – When the file size is larger than 256 KB. – When characters with specified styling are included in the subtitle data. – Codes that specify the character style within files are displayed as subtitle characters. – When data with a different format exists within the subtitle data. ● If the file name of the DivX video file is not displayed correctly on the menu screen (the file name is displayed as "_"), the subtitles text may not be displayed correctly. ● Depending on the disc, the subtitles text cannot be displayed when search and other such operations are being performed. |

- English alphabet and Arabic numerals are displayed correctly. Other characters may not be displayed correctly.
- The display order on this unit may differ from how the order is displayed on a computer.
- Depending on how you create the media (writing software), files and folders may not play in the order you numbered them.
- This unit is not compatible with packet-write format.
- Depending on the recording conditions, the media may not play.
- Operation may take time to complete when there are many files and/or folders and some files may not display or be playable.

*1 ISO9660 level 1 or 2 (except for extended formats), Joliet
This unit is compatible with multi-session.

This unit is not compatible with packet writing.

*2 Discs must conform to UDF 2.0.

*3 Discs must conform to UDF 2.5.

*4 Design rule for Camera File system: unified standard established by Japan Electronics and Information Technology Industries Association (JEITA).

*5 Discs must conform to UDF bridge (UDF 1.02/ISO9660).
This unit is not compatible with multi-session.
The default session only is played.





Messages

The following messages or service numbers appear on the television or unit's display when something unusual is detected during startup and use.

| On the television | | Page |
|--|---|--------------------|
| Authorization Error This unit is not authorized to play this title. | <ul style="list-style-type: none"> ● DivX: You are trying to play the DivX VOD content that was purchased with a different registration code. You cannot play the content on this unit. | 24 |
| Cannot play. | <ul style="list-style-type: none"> ● You inserted an incompatible disc (Discs recorded in PAL video, etc.). | 6, 7 |
| Cannot display on this unit. | <ul style="list-style-type: none"> ● You tried to play a non-compatible image. ● Confirm "SD" on the unit's display is not blinking and re-insert the card. | 7, 35 — |
| No disc is inserted. | <ul style="list-style-type: none"> ● The disc may be upside down. | — |
| Rental Expired. | <ul style="list-style-type: none"> ● DivX: The DivX VOD content has zero remaining plays. You cannot play it. | 24 |
| ⊘ This operation is currently disabled. | <ul style="list-style-type: none"> ● Some operations are prohibited by the unit or disc. For example; <ul style="list-style-type: none"> – BD-V: During play back, reverse slow-motion or reverse frame-by-frame is not possible. – Depending on the disc, you may not be able to perform search or skip when film previews and warning screens are being played back. | 19, 20 — |
| Cannot connect. Please check the connection of the LAN cable. | <ul style="list-style-type: none"> ● When a hub is used but its Link lamp does not light up, check the cable connection, LAN terminal connection, cable itself (a cross over cable may be used by mistake), etc. | 14 |
| IP address is not set. | <ul style="list-style-type: none"> ● The "IP Address" in "IP Address/DNS Settings" is "---. ---. ---. ---". Set the "IP Address", "Subnet Mask", and "Default Gateway". (Select the automatic address acquisition if necessary.) | 17 |
| Cannot obtain IP address using DHCP. Please check the connection or router settings. | <ul style="list-style-type: none"> ● If you use a hub, then check the connection between the hub and the router. <ul style="list-style-type: none"> – Use the UPLINK port of the hub to connect to a router. – Check whether or not the hub's Link lamp lights up. If it does not light up, then check the cable connection, LAN terminal connection, cable itself (a cross over cable may be used by mistake), etc. ● If the above conditions are OK, then the router may not operate in DHCP mode. Check the router settings and operation. You may reset the router to restore it to normal. | 14 |
| This IP address is already in use. Please check the IP address setting. | <ul style="list-style-type: none"> ● This unit's IP address is used by another device. Check the IP addresses of this unit, personal computers, and routers, etc. If necessary, reconfigure them to avoid IP addresses from being duplicated. | — |
| Unable to perform Connection Test. Please try again. | <ul style="list-style-type: none"> ● Turn the unit off. Remove the power cord and reconnect it and try again. If the same symptom persists, then consult your dealer. | — |
| IP address not set correctly. | | |
| Connection Test was unsuccessful. No reply from host. Please check the connection or router settings. | <ul style="list-style-type: none"> ● If you use a hub, then check the connection between the hub and the router. <ul style="list-style-type: none"> – Use the UPLINK port of the hub to connect to a router. – If the hub's Link lamp does not light up, then check the cable connection, LAN terminal connection, cable itself (a cross over cable may have been used by mistake), etc. ● Check the "IP Address", "Subnet Mask", and "Default Gateway" in the "IP Address/DNS Settings". ● If the MAC address information is required, then press [SETUP] to display the "Network" menu. | 14 17 17 |
| Network connection refused. Please confirm Setup "BD-Live Internet Access." | <ul style="list-style-type: none"> ● When you set "BD-Live Internet Access" to "Allow (Limited)" and play BD-Live contents which do not have a content owner certificate, the Internet access of the content is not allowed. If you allow the content to connect to Internet, set "BD-Live Internet Access" to "Allow (ALL)". | 30 |

On the unit's display

Page

| | | |
|--|--|--------------|
| F99 | <ul style="list-style-type: none"> The unit fails to operate properly. Press [POWER /I] on the main unit to switch the unit to standby for 3 seconds. Now press [POWER /I] on the main unit again to turn the unit on. | — |
| HDMI ONLY | <ul style="list-style-type: none"> Some BD-Video discs can only be output with HDMI. | — |
| No PLAY | <ul style="list-style-type: none"> There is a viewing restriction on a BD-Video or DVD-Video. | 30 |
| No READ | <ul style="list-style-type: none"> The disc is dirty or badly scratched. The unit cannot play. | — |
| PLEASE WAIT | <ul style="list-style-type: none"> The unit is carrying out internal process. This is not a malfunction. You cannot operate the unit while "PLEASE WAIT" is displayed. | — |
| SET □ (“□” stands for a number.) | <ul style="list-style-type: none"> The remote control and main unit are using different codes. Change the code on the remote control.  <p>Press and hold [OK] and the indicated number button at the same time for more than 5 seconds.</p> | 33 |
| UNFORMAT | <ul style="list-style-type: none"> You inserted an unformatted DVD-RAM, DVD-RW, +RW, an unused +R, +R DL or DVD-RW (DVD-Video format). | — |
| UNSUPPORT | <ul style="list-style-type: none"> You have inserted a disc the unit cannot play. | 6, 7 |
| U59 | <ul style="list-style-type: none"> The unit is hot. The unit switches to standby for safety reasons. Wait for about 30 minutes until the message disappears. Select a position with good ventilation when installing the unit. Do not block the cooling fan on the rear of the unit. | — |
| U72 U73 | <ul style="list-style-type: none"> The HDMI connection acts unusually. <ul style="list-style-type: none"> The connected equipment is not HDMI compatible. Please use HDMI cables that have the HDMI logo (as shown on the cover). The HDMI cable is damaged. | — |
| H□□ or F□□ | <ul style="list-style-type: none"> There is something unusual. (The service number displayed after H and F depends on the unit's condition.) Check the unit using the troubleshooting guide. If the service number does not disappear, do the following. <ol style="list-style-type: none"> 1) Disconnect the plug from the AC outlet, wait a few seconds, then reconnect it. 2) Press [POWER /I] to turn the power on. (The unit may be fixed.) If the service number does not disappear despite doing the above, request service from the dealer. Inform the dealer of the service number when requesting service. | 38–40 |
| START | <ul style="list-style-type: none"> The system is being restarted during the firmware update. Please do not turn off power. | 14 |
| UPD□/□ | <ul style="list-style-type: none"> The firmware is being updated. | 14 |
| FINISH | <ul style="list-style-type: none"> The firmware update is complete. | 14 |

Troubleshooting guide

Before requesting service, make the following checks. If you are in doubt about some of the check points, or if the solutions indicated in the chart do not solve the problem, refer to "Customer Services Directory" on page 42 if you reside in the U.S.A., or refer to "Product information" on page 44 if you reside in Canada.

The following do not indicate a problem with this unit:

- Regular disc rotating sounds.
- Image disturbance during search.

To reset this unit

| | | Page |
|--|---|------|
| To restore the unit if it freezes due to one of the safety devices being activated | <ul style="list-style-type: none"> • Press and hold [POWER ⏻/I] on the main unit for 3 seconds. (The settings remain unchanged.) | — |
| To return all settings to the factory preset | <ul style="list-style-type: none"> • Select "Yes" in "Restore Default Settings" in the Setup menu. This returns all values in the Setup menu and the on-screen menu, except for "Remote Control Code", "On-screen Language", "IP Address/DNS Settings", "Proxy Server Settings", "DVD-Video Ratings" and "BD-Video Ratings" to the default settings. | 33 |
| To return to the factory preset (No setting) | <ul style="list-style-type: none"> • Reset the unit as follows: <ol style="list-style-type: none"> 1 Press [POWER ⏻/I] on the unit to turn off the unit. 2 Press and hold [■], [POWER ⏻/I] and [▲ OPEN/CLOSE] on the unit at the same time for more than 5 seconds until "HELLO" is displayed on the unit. 3 The power will turn on and then turn off. | — |

Operation

| | | |
|--|--|-----------------------|
| Cannot operate the television or amplifier/receiver. | <ul style="list-style-type: none"> • Change the manufacturer code of the remote control. In some cases, even if you change the code, the remote control may not be operated depending on the type of the televisions or receivers. | 16 |
| The remote control doesn't work properly. | <ul style="list-style-type: none"> • It may be necessary to set the manufacturer code or the remote control code again after changing the batteries for remote control. | 16, 33 |
| | <ul style="list-style-type: none"> • The remote control and main unit are using different codes. Change the code on the remote control. | 33 |
| | <ul style="list-style-type: none"> • The batteries are depleted. Replace them with new ones. | 5 |
| The unit is on but cannot be operated. | <ul style="list-style-type: none"> • Confirm the correct drive is selected. • One of the unit's safety devices may have been activated. Reset the unit as follows: <ol style="list-style-type: none"> 1 Press [POWER ⏻/I] on the main unit to switch the unit to standby. If the unit doesn't switch to standby, press and hold [POWER ⏻/I] on the main unit for about 3 seconds. The unit is forcibly switched to standby. Alternatively, disconnect the AC power supply cord, wait one minute, then reconnect it. 2 Press [POWER ⏻/I] on the main unit to switch it on. If the unit still cannot be operated, consult the dealer. | 19 — |
| | <ul style="list-style-type: none"> • Condensation has formed. Wait 1 to 2 hours for it to evaporate. | — |
| | <ul style="list-style-type: none"> • Insert the disc correctly with the label facing up. • The disc is dirty. • You tried to play a blank disc or unplayable disc on this unit. • DivX: If playing DivX VOD content, refer to the homepage where you purchased it. | 19 3 6, 7 24 |
| Cannot eject disc. | <ul style="list-style-type: none"> • The unit may have a problem. While the unit is off, press and hold [■] and [▲ OPEN/CLOSE] on the main unit at the same time for about 5 seconds to force the tray to eject. Remove the disc and consult the dealer. | — |
| Start up is slow. | <ul style="list-style-type: none"> • Start up takes time in the following situations. <ul style="list-style-type: none"> – Immediately after a power failure or the AC power supply cord is connected. – When the unit is connected with an HDMI cable. • DivX: This is normal on DivX video. | — — |
| Cannot set "On" in "24p Output". | <ul style="list-style-type: none"> • Only when the unit is connected to the HDMI terminal of a TV supporting 24p you can select "On". In some cases where the unit is connected to a TV via an amplifier/receiver through the HDMI terminals, you may not be able to select "On". In this case, connect the unit to a TV through the HDMI terminal and connect it to the amplifier/receiver through any terminal other than HDMI. | 32 |

TV screen and video

Page

| | | |
|---|---|----------------------|
| <p>The images from this unit do not appear on the television.</p> | <ul style="list-style-type: none"> ● Make sure that the television is connected to either the VIDEO OUT terminal, COMPONENT VIDEO OUT terminals or HDMI AV OUT terminal on this unit. | <p>11</p> |
| <p>Picture is distorted.</p> | <ul style="list-style-type: none"> ● Make sure that the television's input setting (e.g., VIDEO 1) is correct. ● An incorrect resolution is selected in "Component Video Resolution", when the television is connected to COMPONENT VIDEO OUT terminals. While stopped, press and hold [■] and [▶] (PLAY) on the main unit at the same time for more than 5 seconds to cancel this setting. Set the item again. | <p>— 32</p> |
| <p>Jittering occurs.</p> | <ul style="list-style-type: none"> ● If "24p Output" is set to "On" when the unit is connected to a TV through any terminal other than HDMI, images may not display properly. In this case, set "24p Output" to "Off". | <p>32</p> |
| | <ul style="list-style-type: none"> ● When "24p Output" is set to "On", HDMI authentication takes place where 24p images switch to other images, and a black screen is displayed. | <p>32</p> |
| | <ul style="list-style-type: none"> ● When "24p Output" is set to "On", jittering may occur while playing DVD-Video other than 24p images. In this case, turn "24p Output" to "Off". | <p>32</p> |
| | <ul style="list-style-type: none"> ● DivX: Images may not be output due to how files were created. | <p>—</p> |
| | <ul style="list-style-type: none"> ● Press [■] and [▶] (PLAY) simultaneously on the unit for more than 5 seconds to shift to more compatible mode with HDMI equipment. However, Dolby Digital Plus, Dolby TrueHD, and DTS-HD audio are not output in bitstream. To output the bitstream, select "Restore Default Settings" to restore the factory presets and make proper settings. | <p>33</p> |
| | <ul style="list-style-type: none"> ● Picture may not be seen when more than 4 devices are connected with HDMI cables. Reduce the number of connected devices. | <p>—</p> |
| <p>The screen changes automatically.</p> | <ul style="list-style-type: none"> ● When the "Screen Saver Function" in the Setup menu is set to "On", the display may return to the screen saver mode automatically if there is no operation for 10 minutes or more. | <p>32</p> |
| <p>Video is not output in high definition.</p> | <ul style="list-style-type: none"> ● High definition video cannot be output through the VIDEO OUT terminals. ● Confirm that the "HDMI Video Mode", "HDMI Resolution", and "Component Video Resolution" in the Setup menu are set properly. | <p>— 32</p> |
| <p>The 4:3 aspect ratio picture expands left and right.</p> | <ul style="list-style-type: none"> ● Use the television to change the aspect. Refer to your television's operating instructions. | <p>—</p> |
| <p>Screen size is wrong.</p> | <ul style="list-style-type: none"> ● When using a component video cable, set "Progressive" to "Video". If the situation is not restored after that, set "TV Aspect" to "4:3 Pan & Scan". ● When using an HDMI cable, change "TV Aspect" type to "16:9". | <p>29, 32 32</p> |
| <p>There is a lot of after-image when playing video.</p> | <ul style="list-style-type: none"> ● Turn "3D NR" or "Integrated NR" off if it is on. | <p>29</p> |
| <p>When playing DVD-Video using progressive output, one part of the picture momentarily appears to be doubled up.</p> | <ul style="list-style-type: none"> ● When you use the HDMI AV OUT terminal for video output, follow the steps below for setting. <ol style="list-style-type: none"> 1 Connect this unit to the TV with any cable except the HDMI cable. 2 When you connect with the Component Video cable, set "HDMI Video Mode" to "Off" and "Component Video Resolution" to "480i" in the Setup menu. | <p>32</p> |
| <p>Still pictures (JPEG) do not playback normally.</p> | <ul style="list-style-type: none"> ● The images that were edited on the PC, such as Progressive JPEG, etc., may not playback. | <p>35</p> |

Sound

| | | |
|---|---|--|
| <p>No sound. Low volume. Distorted sound. Cannot hear the desired audio type.</p> | <ul style="list-style-type: none"> ● Check the connections and the "Digital Audio Output" settings. Check the input mode on the amplifier/receiver if you have connected one. ● Press [AUDIO] to select the audio. ● BD55: When the unit is connected to an amplifier/receiver with the AUDIO OUT terminal, set "Analog Audio Output" and match multi channel speaker settings. If these are not set properly, the audio is not output correctly. ● BD55: When connected to an amplifier/receiver or any other devices using both AUDIO OUT terminal and HDMI AV OUT terminal, the audio from AUDIO OUT terminal may not be output with the desired audio depending on the specifications of the connected devices, etc. Set "HDMI Audio Output" to "Off", when you output multi-channel surround sound from AUDIO OUT terminal. ● The sound effects (Re-master, V. Surround, etc.) will not work when the bitstream signal is output from the HDMI AV OUT terminal or the DIGITAL AUDIO OUT terminal. ● DivX: Audio may not be output depending on how files were created. ● Audio may not be heard when more than 4 devices are connected with HDMI cables. Reduce the number of connected devices. ● To output audio from a device connected with an HDMI cable, set "HDMI Audio Output" to "On" in the Setup menu. | <p>11–13, 31 20 32, 34 32 — — — 32</p> |
| <p>Cannot switch audio.</p> | <ul style="list-style-type: none"> ● There are discs for which audio cannot be changed because of how the disc was created. ● When connecting an amplifier/receiver using a coaxial cable (BD55), optical digital audio cable or an HDMI cable, you cannot switch the audio if "Dolby D/ Dolby D +/Dolby TrueHD" or "DTS/DTS-HD" is set to "Bitstream". Set "Dolby D/ Dolby D +/Dolby TrueHD" or "DTS/DTS-HD" to "PCM" or connect using AUDIO OUT terminal. | <p>— 12, 13, 31</p> |

Troubleshooting guide

| Card | | Page |
|--|---|--------|
| The capacity of the SD card decreased. | <ul style="list-style-type: none"> When a BD-Video that supports the virtual package is used, and an SD card is in the slot, data may be written to the SD card. Erase the data by using "BD-Video Data Erase", format the card or use a new card. | 21 |
| MPEG-2 motion pictures and music on an SD card cannot be played. | <ul style="list-style-type: none"> Data that can be played from an SD card are AVCHD and JPEG data. | 7 |
| The contents of the card cannot be read. | <ul style="list-style-type: none"> The card is not compatible or the contents on the card may be damaged. Turn off and then turn on the unit again. | 7 — |

Network

| | | |
|---------------------------------|---|--------|
| I can't connect to the network. | <ul style="list-style-type: none"> Are you subscribed to high speed internet connection? Check that the LAN cable is properly connected. | 14 |
| | <ul style="list-style-type: none"> Have you plugged a telephone cord into the LAN terminal on this unit? Connect with a straight LAN cable. | 14 |
| | <ul style="list-style-type: none"> Confirm the power for the modem or broadband router is turned on. | — |
| | <ul style="list-style-type: none"> Confirm the network settings. Follow any instructions you may have received from your ISP (Internet Service Provider) and make changes to the settings. | — |
| | <ul style="list-style-type: none"> Are the broadband router settings correct? Read the operating instructions for the broadband router. | — |
| | <ul style="list-style-type: none"> Is the broadband router and/or modem connected correctly? Check the operating instructions for each device and connect accordingly. | — |
| | <ul style="list-style-type: none"> Check the "Network" and "BD-Live Internet Access" settings. | 30, 33 |

Other difficulties with playback

| | | |
|--|---|--------------------|
| Audio and video momentarily pause. | <ul style="list-style-type: none"> This occurs between playlist chapters or scenes (AVCHD). When playing a title recorded on both layers, the unit automatically switches between layers and plays the title in the same way as a normal program. However, video and audio may momentarily cut out when the unit is switching layers. | — — |
| Picture-in-picture is not played with BD-Video. | <ul style="list-style-type: none"> Confirm whether the disc supports picture-in-picture. | — |
| The virtual package is not played with BD-Video. | <ul style="list-style-type: none"> Confirm whether the disc supports the virtual package. The inserted SD card does not have sufficient available capacity. The SD card is write-protected. Sub contents copied to an SD card are provided by the disc producer as a part of the BD-Video content. Even if you record images and audio onto an SD card, it cannot be played as a virtual package. | 21 — 7 21 |
| Alternative soundtrack and subtitles cannot be selected. | <ul style="list-style-type: none"> The languages are not recorded on the disc. You may not be able to use the on-screen menu to change the soundtrack and subtitles on some discs. Use the disc's menus to make changes. | — 19 |
| No subtitles. | <ul style="list-style-type: none"> Subtitles are not recorded on the disc. Turn the subtitles on. Set "Subtitle" on the on-screen menu to "On". When progressive output is on, closed captions cannot be displayed. | — 28 — |
| The subtitles overlap closed captions recorded on discs. | <ul style="list-style-type: none"> Turn off the subtitles or turn off the closed caption setting on the TV. | 28 |
| The resume play function does not work. | <ul style="list-style-type: none"> Memorized positions are canceled when <ul style="list-style-type: none"> pressing [■] several times. opening the disc tray. The resume play function may not work depending on the disc. BD-V: On BD-Video discs including BD-J, the resume play function does not work. | — — — |

Specifications

Signal system:

NTSC

Operating temperature range:

+5 °C to +35 °C (+41 °F to +95 °F)

Operating humidity range:

10 % to 80 % RH (no condensation)

Playable disc:

BD-Video

BD-ROM: Version 2

BD-RE: Version 3 (Single Layer, Dual Layer), JPEG*6

BD-R Version 2 (Single Layer, Dual Layer)

DVD-RAM: DVD Video Recording format, AVCHD format*8, JPEG*4

DVD-R/DVD-R DL:

DVD-Video format*1, DVD-Video Recording format*1, AVCHD format*1, 8, DivX*7

DVD-RW: DVD-Video format*1, DVD-Video Recording format*1, AVCHD format*1, 8

+R/+RW/+R DL:

Video*1, AVCHD format*1, 8

DVD-VIDEO:

DVD-Video format

CD-Audio: CD-DA

CD-R/CD-RW: CD-DA, JPEG*5, MP3, DivX*7

SD card:

SD Memory Card*2 formatted FAT12, FAT16, FAT32*3:
JPEG*4, AVCHD format*8

Video output:

Output level: 1.0 Vp-p (75 Ω)

Output connector: Pin jack (1 system)

Component video output:

(1080i/720p/480p/480i)

Y output level: 1.0 Vp-p (75 Ω)

P_B output level: 0.7 Vp-p (75 Ω)

P_R output level: 0.7 Vp-p (75 Ω)

Output connector: Pin jack (Y: green, P_B: blue, P_R: red)
(1 system)

Audio output:

Output level: 2 Vrms (1 kHz, 0 dB)

Output connector: Pin jack

Number of connectors :

BD55: 7.1 channel discrete output: 1 system
(2 channel + 5.1 channel discrete output)

BD35: 2 channel: 1 system

Audio performance:

Frequency response:

•DVD (linear audio): 4 Hz to 22 kHz (48 kHz sampling)
4 Hz to 44 kHz (96 kHz sampling)

•CD-Audio: 4 Hz to 20 kHz

S/N ratio: 115 dB

Dynamic range: 100 dB

Total harmonic distortion: 0.003 %

Digital audio output:

Optical digital output:

Optical terminal

Coaxial digital output **BD55**:

Pin jack

HDMI AV output

Output format:

480p (525p)/1080i (1125i)/720p (750p)/1080p
(1125p)

Output Connector:

Type A (19 pin)

HDMI™ (Deep color, x.v.Color™, High Bit rate Audio)

•This unit supports "HDAVI Control 3" function.

SD card slot:

Output connector:

1 system

Ethernet:

10BASE-T/100BASE-TX:

1 system

Optical pick-up:

System with 2 lenses

Wave length:

(RQT9243) 782 nm (CDs)/662 nm (DVDs)/405 nm (BDs)
(RQT9350) 790 nm (CDs)/650 nm (DVDs)/405 nm (BDs)

LASER Specification

Class I LASER Product:

Wave length:

(RQT9243) 782 nm (CDs)/662 nm (DVDs)/405 nm (BDs)
(RQT9350) 790 nm (CDs)/650 nm (DVDs)/405 nm (BDs)

Laser power:

No hazardous radiation is emitted with the safety protection

Power supply:

AC 120 V, 60 Hz

Power consumption:

BD55: Approx. 21 W

BD35: Approx. 20 W

Power consumption in standby mode: **less than 0.6 W**

Dimensions (W×D×H)

BD55:

Excluding the projecting parts:

430 mm×242 mm×55 mm
(Approx. 16 15/16"×9 9/16"×2 3/16")

Including the projecting parts:

430 mm×249 mm×55 mm
(Approx. 16 15/16"×9 13/16"×2 3/16")

BD35:

Excluding the projecting parts:

430 mm×242 mm×49 mm
(Approx. 16 15/16"×9 9/16"×1 15/16")

Including the projecting parts:

430 mm×249 mm×49 mm
(Approx. 16 15/16"×9 13/16"×1 15/16")

Mass (Weight):

Approx. 2.6 kg (5.7 lbs)

Specifications are subject to change without notice.

*1 Finalizing is necessary.

*2 Includes SDHC card

Includes miniSD Cards (need a miniSD Adaptor)

Includes microSD Cards (need a microSD Adaptor)

*3 Does not support long file name

*4 The total combined maximum number of recognizable picture contents and folders: 3000 picture contents and 300 folders.

*5 The total combined maximum number of recognizable picture contents and folders: 999 picture contents and 99 folders.

*6 The total combined maximum number of recognizable picture contents and folders: 9999 picture contents and 300 folders.

*7 **BD55**: The total combined maximum number of recognizable picture contents and folders: 200 file contents and 300 folders.

*8 AVCHD format V1.0

•Useable capacity will be less. (SD Card)

Limited Warranty (ONLY FOR U.S.A.)

Panasonic Consumer Electronics Company,
Division of Panasonic Corporation of North America
One Panasonic Way Secaucus, New Jersey 07094

Panasonic Puerto Rico, Inc.
Ave. 65 de Infantería, Km. 9.5
San Gabriel Industrial Park, Carolina, Puerto Rico 00985

Panasonic Blu-ray Disc Player Limited Warranty

Limited Warranty Coverage

If your product does not work properly because of a defect in materials or workmanship, Panasonic Consumer Electronics Company or Panasonic Puerto Rico, Inc. (collectively referred to as "the warrantor") will, for the length of the period indicated on the chart below, which starts with the date of original purchase ("Limited Warranty period"), at its option either (a) repair your product with new or refurbished parts, or (b) replace it with a new or a refurbished product. The decision to repair or replace will be made by the warrantor.

| Product or Part Name | Parts | Labor |
|----------------------|--------------|--------------|
| Blu-ray Disc Player | One (1) Year | One (1) Year |

During the "Labor" Limited Warranty period there will be no charge for labor. During the "Parts" warranty period, there will be no charge for parts. You must mail-in your product during the warranty period. If non-rechargeable batteries are included, they are not warranted. This Limited Warranty only applies to products purchased and serviced in the United States or Puerto Rico. This Limited Warranty is extended only to the original purchaser and only covers product purchased as new. A purchase receipt or other proof of original purchase date is required for Limited Warranty service.

For assistance in Puerto Rico call Panasonic Puerto Rico, Inc. (787)-750-4300 or fax (787)-768-2910.

When shipping the unit carefully pack and send it prepaid, adequately insured and preferably in the original carton. Include a letter detailing the complaint and provide a day time phone and/or email address where you can be reached.

IF REPAIR IS NEEDED DURING THE LIMITED WARRANTY PERIOD THE PURCHASER WILL BE REQUIRED TO FURNISH A SALES RECEIPT/PROOF OF PURCHASE INDICATING DATE OF PURCHASE, AMOUNT PAID AND PLACE OF PURCHASE. CUSTOMER WILL BE CHARGED FOR THE REPAIR OF ANY UNIT RECEIVED WITHOUT SUCH PROOF OF PURCHASE.

Limited Warranty Limits And Exclusions

This Limited Warranty ONLY COVERS failures due to defects in materials or workmanship, and DOES NOT COVER normal wear and tear or cosmetic damage. The Limited Warranty ALSO DOES NOT COVER damages which occurred in shipment, or failures which are caused by products not supplied by the warrantor, or failures which result from accidents, misuse, abuse, neglect, mishandling, misapplication, alteration, faulty installation, set-up adjustments, misadjustment of consumer controls, improper maintenance, power line surge, lightning damage, modification, or commercial use (such as hotel, office, restaurant, or other business), rental use of the product, or service by anyone other than a Factory Servicenter or other Authorized Servicer, or damage that is attributable to acts of God.

THERE ARE NO EXPRESS WARRANTIES EXCEPT AS LISTED UNDER "LIMITED WARRANTY COVERAGE". THE WARRANTOR IS NOT LIABLE FOR INCIDENTAL OR CONSEQUENTIAL DAMAGES RESULTING FROM THE USE OF THIS PRODUCT, OR ARISING OUT OF ANY BREACH OF THIS WARRANTY. (As examples, this excludes damages for lost time, cost of having someone remove or re-install an installed unit if applicable, travel to and from the servicer, loss of or damage to media or images, data or other recorded content. The items listed are not exclusive, but are for illustration only.)

ALL EXPRESS AND IMPLIED WARRANTIES, INCLUDING THE WARRANTY OF MERCHANTABILITY, ARE LIMITED TO THE PERIOD OF THE LIMITED WARRANTY.

Some states do not allow the exclusion or limitation of incidental or consequential damages, or limitations on how long an implied Limited Warranty lasts, so the exclusions may not apply to you.

This Limited Warranty gives you specific legal rights and you may also have other rights which vary from state to state. If a problem with this product develops during or after the Limited Warranty period, you may contact your dealer or Servicenter. If the problem is not handled to your satisfaction, then write to the warrantor's Consumer Affairs Department at the addresses listed for the warrantor.

PARTS AND SERVICE, WHICH ARE NOT COVERED BY THIS LIMITED WARRANTY, ARE YOUR RESPONSIBILITY.

Customer Services Directory

Obtain Product Information and Operating Assistance; purchase Parts, Accessories, or obtain Literature by visiting our Web Site at:

<http://www.panasonic.com/consumersupport>

or, contact us via the web at:

<http://www.panasonic.com/contactinfo>

You may also contact us directly at:

1-800-211-PANA (7262),

Monday-Friday 9 am-9 pm; Saturday-Sunday 10 am-7 pm, EST.

For hearing or speech impaired TTY users, TTY: 1-877-833-8855

Accessory Purchases

Purchase Parts, Accessories and Instruction Books online for all Panasonic Products by visiting our Web Site at:

<http://www.pstc.panasonic.com>

or, send your request by E-mail to:

npcparts@us.panasonic.com

You may also contact us directly at:

1-800-332-5368 (Phone) 1-800-237-9080 (Fax Only) (Monday - Friday 9 am to 9 pm, EST.)

Panasonic Service and Technology Company

20421 84th Avenue South, Kent, WA 98032

(We Accept Visa, MasterCard, Discover Card, American Express, and Personal Checks)

For hearing or speech impaired TTY users, TTY: 1-866-605-1277

Product Repairs

MAIL TO:

Centralized Factory Servicenter

Panasonic Service and Technology Company

410B Airport Road

Elgin, IL 60123-9333

Attention: BD/DVD Repair

Please carefully pack and ship, prepaid and insured, to the Elgin Centralized Factory Servicenter. Customers in Puerto Rico, please ship or carry in to location below ("Service in Puerto Rico").

Service in Puerto Rico

Panasonic Puerto Rico, Inc.

Ave. 65 de Infantería, Km. 9.5, San Gabriel Industrial Park, Carolina, Puerto Rico 00985

Phone (787)750-4300, Fax (787)768-2910

Limited Warranty (ONLY FOR CANADA)

Panasonic Canada Inc.

PANASONIC PRODUCT—LIMITED WARRANTY

Panasonic Canada Inc. warrants this product to be free from defects in material and workmanship and agrees to remedy any such defect for a period as stated below from the date of original purchase.

| | |
|--|---------------------------------------|
| Technics Audio Product | One (1) year, parts and labour |
| Panasonic Portable/Clock Radio (without Tape, CD, MD) | One (1) year, parts and labour |
| Panasonic Audio/SD Audio Product | One (1) year, parts and labour |
| Panasonic BD/DVD Product | One (1) year, parts and labour |
| Panasonic Combination DVD Player/VCR | One (1) year, parts and labour |
| Panasonic Combination DVD Recorder/VCR | One (1) year, parts and labour |
| Accessories including rechargeable batteries | Ninety (90) days |

LIMITATIONS AND EXCLUSIONS

This warranty does not apply to products purchased outside Canada or to any product which has been improperly installed, subjected to usage for which the product was not designed, misused or abused, damaged during shipping, or which has been altered or repaired in any way that affects the reliability or detracts from the performance, nor does it cover any product which is used commercially. Dry cell batteries are also excluded from coverage under this warranty.

This warranty is extended to the original end user purchaser only. A purchase receipt or other proof of date of original purchase is required before warranty service is performed.

THIS EXPRESS, LIMITED WARRANTY IS IN LIEU OF ALL OTHER WARRANTIES, EXPRESS OR IMPLIED, INCLUDING ANY IMPLIED WARRANTIES OF MERCHANTABILITY AND FITNESS FOR A PARTICULAR PURPOSE.

IN NO EVENT WILL PANASONIC CANADA INC. BE LIABLE FOR ANY SPECIAL, INDIRECT OR CONSEQUENTIAL DAMAGES.

In certain instances, some jurisdictions do not allow the exclusion or limitation of incidental or consequential damages, or the exclusion of implied warranties, so the above limitations and exclusions may not be applicable.

WARRANTY SERVICE

FOR PRODUCT OPERATION ASSISTANCE, please contact:

Our Customer Care Centre: Telephone #: (905) 624-5505
1-800 #: 1-800-561-5505
Fax #: (905) 238-2360
Email link: "Customer support" on www.panasonic.ca

FOR PRODUCT REPAIRS, please locate your nearest Authorized Servicentre at www.panasonic.ca :

Link : "Servicentres™ locator" under "Customer support"

IF YOU SHIP THE PRODUCT TO A SERVICENTRE

Carefully pack and send prepaid, adequately insured and preferably in the original carton.
Include details of the defect claimed, and proof of date of original purchase.

Product Service

1. **Damage requiring service**—The unit should be serviced by qualified service personnel if:
 - (a) The AC power supply cord or AC adaptor has been damaged; or
 - (b) Objects or liquids have gotten into the unit; or
 - (c) The unit has been exposed to rain; or
 - (d) The unit does not operate normally or exhibits a marked change in performance; or
 - (e) The unit has been dropped or the cabinet damaged.
2. **Servicing**—Do not attempt to service the unit beyond that described in these operating instructions. Refer all other servicing to authorized servicing personnel.
3. **Replacement parts**—When parts need replacing ensure the servicer uses parts specified by the manufacturer or parts that have the same characteristics as the original parts. Unauthorized substitutes may result in fire, electric shock, or other hazards.
4. **Safety check**—After repairs or service, ask the servicer to perform safety checks to confirm that the unit is in proper working condition.

Product information

For product information or assistance with product operation:
 In the U.S.A., refer to "Customer Services Directory" on page 42.
 In Canada, contact the Panasonic Canada Inc. Customer Care Centre at 1-800-561-5505, or visit the website (www.panasonic.ca), or an authorized Servicentre closest to you.

The model number and serial number of this product can be found on either the back or the bottom of the unit. Please note them in the space provided below and keep for future reference.

MODEL NUMBER _____

SERIAL NUMBER _____

User memo:

DATE OF PURCHASE _____

DEALER NAME _____

DEALER ADDRESS _____

TELEPHONE NUMBER _____

Licenses

| |
|--|
| Java and all Java-based trademarks and logos are trademarks or registered trademarks of Sun Microsystems, Inc. in the United States and other countries. |
| Manufactured under license from Dolby Laboratories. Dolby and the double-D symbol are trademarks of Dolby Laboratories. |
| Manufactured under license under U.S. Patent #'s: 5,451,942; 5,956,674; 5,974,380; 5,978,762; 6,226,616; 6,487,535 & other U.S. and worldwide patents issued & pending. DTS is a registered trademark and the DTS logos, Symbol, DTS-HD and DTS-HD Master Audio Essential are trademarks of DTS, Inc. © 1996-2008 DTS, Inc. All Rights Reserved. |
| U.S. Patent Nos. 6,836,549; 6,381,747; 7,050,698; 6,516,132; and 5,583,936. |
| This product incorporates copyright protection technology that is protected by U.S. patents and other intellectual property rights. Use of this copyright protection technology must be authorized by Macrovision, and is intended for home and other limited viewing uses only unless otherwise authorized by Macrovision. Reverse engineering or disassembly is prohibited. |
| HDMI, the HDMI logo and High-Definition Multimedia Interface are trademarks or registered trademarks of HDMI Licensing LLC. |
| This product is licensed under the AVC patent portfolio license and VC-1 patent portfolio license for the personal and non-commercial use of a consumer to (i) encode video in compliance with the AVC Standard and VC-1 Standard ("AVC/VC-1 Video") and/or (ii) decode AVC/VC-1 Video that was encoded by a consumer engaged in a personal and non-commercial activity and/or was obtained from a video provider licensed to provide AVC/VC-1 Video. No license is granted or shall be implied for any other use. Additional information may be obtained from MPEG LA, LLC. See http://www.mpegla.com . |
| HDAVI Control™ is a trademark of Panasonic Corporation. |
| "x.v.Color" is trademark. |
| VIERA Link™ is a trademark of Panasonic Corporation. |
| EZ Sync™ is a trademark of Panasonic Corporation. |
| "AVCHD" and the "AVCHD" logo are trademarks of Panasonic Corporation and Sony Corporation. |
| SDHC Logo is a trademark. |
| Portions of this product are protected under copyright law and are provided under license by ARIS/SOLANA/4C. |
| Official DivX® Certified product. Plays all versions of DivX® video (including DivX®6) with standard playback of DivX® media files.  DivX, DivX Certified, and associated logos are trademarks of DivX, Inc. and are used under license. |
| "Blu-ray Disc" is trademark. |
| "BD-LIVE" logo is trademark of Blu-ray Disc Association. |
| "BONUSVIEW" is trademark of Blu-ray Disc Association. |

Referencia rápida en español (Spanish Quick Reference)

Conexiones básicas

A Conexión a un televisor compatible con HDMI

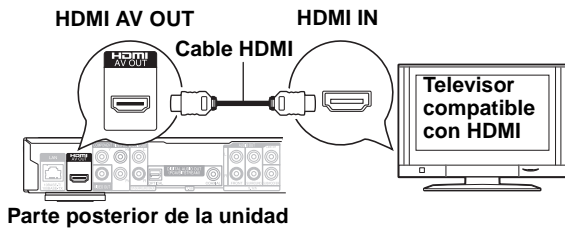

Parte posterior de la unidad

B Conexión a un televisor con un cable para audio/vídeo

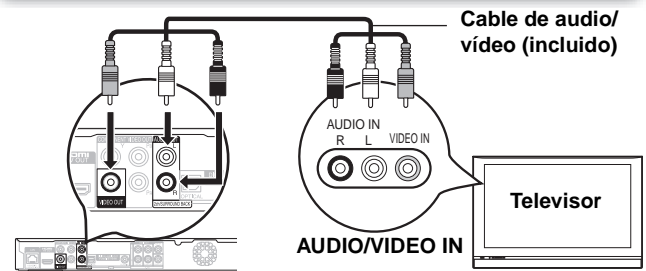

Parte posterior de la unidad

- Esta conexión no permite la salida de vídeo de alta definición. Utilice la conexión **A** o **C** para obtener vídeo de alta definición.

C Conexión a un televisor compatible con HDMI y a un amplificador/receptor compatible con HDMI

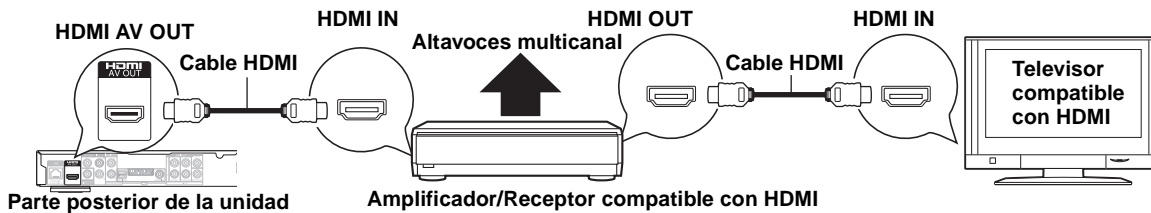

Parte posterior de la unidad

Amplificador/Receptor compatible con HDMI

Conecte el cable de alimentación de CA por último

A una toma de corriente doméstica

(CA 120 V, 60 Hz)

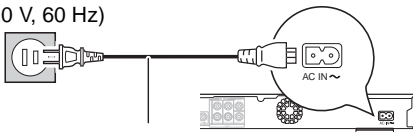

Cable de alimentación de CA (incluido)

Conéctelo cuando haya realizado el resto de conexiones.

Ahorro de energía

Esta unidad consume una pequeña cantidad de energía aunque esté ajustada en el modo de espera (aprox. 0.6 W). Para ahorrar energía cuando no vaya a utilizar la unidad durante mucho tiempo, desenchúfela de la toma de corriente.

Reproducción básica

Preparación

Encienda el televisor y seleccione la entrada de vídeo adecuada en el televisor.

1 Pulse [⏻ BD POWER] para encender la unidad.

Después de conectar su nuevo reproductor y pulsar el botón de encendido, aparecerá la pantalla de la configuración básica.

2 Pulse [▶ OPEN/CLOSE] para abrir la bandeja del disco, cargue el disco.



Inicia la reproducción



Parada

La posición de detención se memoriza.

Función de reanudación de la reproducción

Pulse [▶] (PLAY) para reiniciar la reproducción desde esta posición.

- La posición se borra si se abre la bandeja o se pulsa [■] varias veces para visualizar "STOP" en el visor de la unidad.
- **BD-V**: En los discos BD-Vídeo incluidos los BD-J, la función de reanudación de la reproducción no funciona.
- **CD** **MP3** **DivX** (**BD55**): La posición se borra si apaga la unidad.



Pausa

- Pulse [||] otra vez o [▶] (PLAY) para reiniciar la reproducción.

SLOW/SEARCH



Búsqueda/Cámara lenta

La velocidad aumenta hasta 5 pasos.

- Pulse [▶] (PLAY) para recuperar la velocidad de reproducción normal.

- Para algunos discos, la velocidad podría no cambiar.

Búsqueda

Durante la reproducción, pulse [◀◀] o [▶▶].

- **BD-V** **AVCHD** **DVD-VR** **DVD-V**: El audio se oye durante la búsqueda en avance de primer nivel.
- **DivX** **BD55**: El sonido no se oye durante todos los niveles de búsqueda.
- **CD** **MP3**: La velocidad está fija en un paso.

Cámara lenta

Durante la pausa, pulse [◀◀] o [▶▶].

- **BD-V** **AVCHD**: Sólo dirección en avance [▶▶].
- **DVD-VR**: Si continúa durante aprox. 5 minutos, la reproducción en cámara lenta se para automáticamente.



Salto

- Salta hasta el título, capítulo o pista que desee reproducir.
- Cada pulsación aumenta el número de saltos.
- **DivX** **BD55**: Solo dirección hacia atrás [◀◀].

Glossary

AVCHD

AVCHD is a new format (standard) for high definition video cameras that can be used to record and play high-resolution HD images.

BD-J

Some BD-Video discs contain Java applications, and these applications are called BD-J. You can enjoy various interactive features in addition to playing normal video.

BD-Live

This is a BD-Video (BD-ROM version 2 Profile 2) that supports the new functions such as Internet connection, etc. in addition to the BONUSVIEW function.

Bitstream

This is the digital form of multi-channel audio data (e.g., 5.1 channel) before it is decoded into its various channels.

BONUSVIEW (Final Standard Profile)

This is a BD-Video (BD-ROM version 2 Profile 1 version 1.1) that supports the new functions such as Picture-in-picture, Secondary Audio, and Virtual Package, etc.

Deep Color

Deep Color is a name for device that can reproduce greater color gradation (4096 steps) when connected to a TV that supports the deep color with HDMI cable. You can enjoy exceptionally rich, natural-looking colors, with smooth, detailed gradation and minimal color banding. [A lower color gradation (256 steps), without deep color, will be reproduced if connected to a TV which does not support deep color. The unit will automatically set appropriate output to suit the connected TV.]

DivX BD55

DivX is a popular media technology created by DivX, Inc. DivX media files contain highly compressed video with high visual quality that maintains a relatively small file size.

DNS Server

A server which acts like a telephone directory and translates Internet domain names into IP addresses.

Dolby Digital

This is a method of coding digital signals developed by Dolby Laboratories. Apart from stereo (2-channel) audio, these signals can also be multi-channel audio.

Dolby Digital Plus

Multi-channel audio and higher audio quality is made possible using Dolby Digital Plus. BD-Video supports up to 7.1 channel output.

Dolby TrueHD

Dolby TrueHD is a very high quality audio format that reproduces the studio master audio. BD-Video supports up to 7.1 channel output.

Down-mixing

This is the process of remixing the multi-channel audio found on some discs into fewer channels.

DTS (Digital Theater Systems)

This surround system is used in many movie theaters. There is good separation between the channels, so realistic sound effects are possible.

DTS-HD

DTS-HD is a high-quality, sophisticated audio format used in movie theaters. Previous DTS Digital Surround-compatible equipment can play DTS-HD as DTS Digital Surround audio. BD-Video supports up to 7.1 channel output.

DTS-HD High Resolution Audio

This is a signal format achieved by improving the previous DTS, DTS-ES and DTS96/24 formats. It is compatible with sampling frequency 96 kHz/48 kHz. BD-Video supports up to 7.1 channel output.

DTS-HD Master Audio

This is a lossless audio format and compatible with 96 kHz/7.1ch or less. In addition, faithful reproduction of the master audio is enabled using lossless audio encoding technology. BD-Video supports up to 7.1 channel output.

Dynamic range

Dynamic range is the difference between the lowest level of sound that can be heard above the noise of the equipment and the highest level of sound before distortion occurs.

Dynamic range compression means reducing the gap between the loudest and softest sounds. This means you can listen at low volumes but still hear dialog clearly.

Film and video

DVD-Video are recorded using either film or video. This unit can determine which type has been used, then uses the most suitable method of progressive output.

Film: Recorded at 24 frames per second. (Recorded at 30 frames per second as well). Generally appropriate for motion picture films.

Video: Recorded at 30 frames/60 fields per second. Generally appropriate for TV drama programs or animation.

Frames and fields

Frames refer to the single images that constitute the video you see on your television. Each frame consists of two fields.



Frame

- A frame still shows two fields, so there may be some blurring, but picture quality is generally better.

- A field still shows less picture information so it may be rougher, but there is no blurring.

Field

Field

Gateway

IP address of the electronic device providing Internet access. Usually called a router IP address. (e.g., 192.168.0.1)

HDMI (High-Definition Multimedia Interface)

HDMI is a digital interface for consumer electronic products. Unlike conventional connections, it transmits uncompressed digital video and audio signals on a single cable.

Hub

Used for connecting more than one device to the network.

IP address

A set of numbers which distinguish each device on the network when, for example, connected to the Internet. When using a PC in a LAN to access a PC or device that is not included in the LAN, the IP address is called the local IP address. (e.g., 192.168.0.10)

JPEG (Joint Photographic Experts Group)

This is a system used for compressing/decoding color still pictures. If you select JPEG as the storage system on digital cameras, etc., the data will be compressed to 1/10–1/100 of its original size. The benefit of JPEG is less deterioration in picture quality considering the degree of compression.

LAN (Local Area Network)

A group of linked devices in a company, school or home. Indicates the boundaries of a particular network.

Local storage

This storage area is used as a destination for sub contents for playing virtual packages on BD-Video.

LPCM (Linear PCM)

These are a kind of PCM format.

These are uncompressed digital signals, similar to those found on CDs.

MP3 (MPEG Audio Layer 3)

An audio compression method that compresses audio to approximately one tenth of its size without any significant loss of audio quality.

P4HD (Pixel Precision Progressive Processing for HD)

This is a processor which makes use of an exclusive Panasonic algorithm. Various processing is supported, including a high-level conversion of the TV scanning format from interlace to progressive and a high-level conversion of standard resolution (480i or 576i) video signal to a 1080 High Definition video signal. Consequently, this unit is able to provide video of optimal resolution to the connected TV.

Pan&Scan/Letterbox

In general, DVD-Video are produced with the intention that they be viewed on a widescreen television (16:9 aspect ratio), so images often don't fit regular (4:3 aspect ratio) televisions. Two styles of picture, "Pan & Scan" and "Letterbox", deal with this problem.

Pan&Scan: The sides are cut off so the picture fills the screen.



Letterbox: Black bands appear at the top and bottom of the picture so the picture itself appears in an aspect ratio of 16:9.



PCM (Pulse Code Modulation)

This is one format for converting analog audio into digital audio, enabling you to enjoy digital audio with no hassle.

Progressive/Interlace

The video signal standard of NTSC has 480 interlaced (i) scan lines, whereas progressive (p) scanning uses twice the number of scan lines, and this is referred to as 480p. Using progressive output, you can enjoy watching high resolution video.

Router

Distinguishes the IP address assigned to each device, such as the PC, and relays the flow of data within the network.

Sampling frequency

Sampling is the process of converting the heights of sound wave (analog signal) samples taken at set periods into digits (digital encoding). Sampling frequency is the number of samples taken per second, so larger numbers mean more faithful reproduction of the original sound.

Subnet mask

Enables efficient network use. A set of numbers which identify which part of the IP address allocated to every device connected to the router is the network portion.

x.v.Color

x.v.Color is a name for devices that are compatible with the xvYCC format, an international standard for expanded color in motion pictures, and that follow the rules for signal transmission.

You can enjoy vivid colors of wider color ranges for a more realistic picture when connected to a TV that supports the x.v.Color with HDMI cable.

1080i (1125i)

In one high definition image, 1080 (1125) alternating scan lines pass to create an interlaced image. Because 1080i (1125i) more than doubles current television broadcasts of 480i, the detail is much clearer and creates a more realistic and rich image.

1080p (1125p)

In one high definition image, 1080 (1125) scan lines pass at the same time to create a progressive image. Since progressive video does not alternate scan lines like interlace, there is a minimal amount of screen flicker.

24p

This is a progressive image recorded at a rate of 24 frames per second.

720p (750p)

In one high definition image, 720 (750) scan lines pass at the same time to create a progressive image. Since progressive video does not alternate scan lines like interlace, there is a minimal amount of screen flicker.

Index

| | | | | | |
|---|------------|--|------------|---|--------|
| A AC Power Connection | 13 | Format | 21 | Properties | |
| Angle | 28 | Frame-by-frame | 20 | Chapter | 22 |
| Audio | | H HDMI | 11, 12, 46 | Still picture | 23 |
| Attribute | 28 | I IP address | 17, 46 | Proxy Server | 18 |
| Changing audio | 20 | J JPEG | 22, 35, 46 | P4HD | 47 |
| Channel | 28 | L LAN | 14, 46 | Ratings level | 30 |
| Language | 28, 30 | Language | | Re-master | 20, 29 |
| AVCHD | 46 | Audio | 28, 30 | Remote control | |
| B BD-J | 46 | Code list | 30 | Remote control code | 33 |
| BD-Live | 21, 46 | On-screen | 32 | Reprogramming the | |
| BD-Video Ratings | 30 | Soundtrack | 28 | remote control | 16 |
| BONUSVIEW (Final Standard Profile) | | Subtitle | 28, 30 | Using the remote control | 5 |
| | 21, 46 | Local storage | 46 | Repeat play | 29 |
| C Chapter | 22 | LPCM | 46 | Restore Default Settings | 33 |
| Cleaning | | M Maintenance | 3 | Resume play function | 19 |
| Disc | 3 | Menu | | S SD card | 7, 21 |
| Lens | 3 | On-screen | 28 | Search | 19 |
| Main unit | 3 | Pop-up | 19 | Selected playback | 19 |
| Connections | | Setup | 30 | Setup menu | 30 |
| Amplifier/Receiver | 12, 13 | MP3 | 25, 35, 46 | Skip | 19 |
| HDMI | 11, 12 | N Noise reduction (NR) | | Slideshow | 23 |
| D Deep Color | 46 | Integrated NR | 29 | Slow-motion | 19 |
| Dialog Enhancer | 29 | 3D NR | 29 | Soundtrack | 28 |
| Direct Navigator | 19 | O Off Timer | 33 | Status Message | 20 |
| Disc and card handling | 3 | On-screen | | Still pictures | 22 |
| Discs that cannot be played | 7 | Language | 32 | Subtitle | 28 |
| DivX | 24, 35, 46 | Menu | 28 | Switch drives | 19 |
| DNS Server | 17, 46 | Status messages | 20 | V V. Surround | 29 |
| Dolby Digital | 31, 46 | P PCM Down Conversion | 31 | VIERA Link™ "HDAVI Control™" | 26 |
| Dolby Digital Plus | 8, 31, 46 | Picture-in-picture | 21 | Virtual package | 21 |
| Dolby TrueHD | 8, 31, 46 | Playlist | 20 | X x.v.Color | 47 |
| DTS | 31, 46 | Pop-up Menu | 19 | 24p | 29, 32 |
| DTS-HD | 8, 31, 46 | Product Disposal | 3 | | |
| F Finalize | 6 | Progressive | 29, 47 | | |
| Firmware | 14 | | | | |

-If you see this symbol-

Information on Disposal in other Countries outside the European Union



This symbol is only valid in the European Union. If you wish to discard this product, please contact your local authorities or dealer and ask for the correct method of disposal.

For U.S.A.

Panasonic Consumer Electronics Company, Division of Panasonic Corporation of North America

One Panasonic Way Secaucus, New Jersey 07094
<http://www.panasonic.com>

Panasonic Puerto Rico, Inc.

Ave. 65 de Infantería, Km. 9.5
 San Gabriel Industrial Park, Carolina,
 Puerto Rico 00985

For Canada

Panasonic Canada Inc.

5770 Ambler Drive
 Mississauga, Ontario
 L4W 2T3
www.panasonic.ca



Free Manuals Download Website

<http://myh66.com>

<http://usermanuals.us>

<http://www.somanuals.com>

<http://www.4manuals.cc>

<http://www.manual-lib.com>

<http://www.404manual.com>

<http://www.luxmanual.com>

<http://aubethermostatmanual.com>

Golf course search by state

<http://golfingnear.com>

Email search by domain

<http://emailbydomain.com>

Auto manuals search

<http://auto.somanuals.com>

TV manuals search

<http://tv.somanuals.com>