

Panasonic

DVD/VIDEO CD/CD PLAYER

Operating Instructions

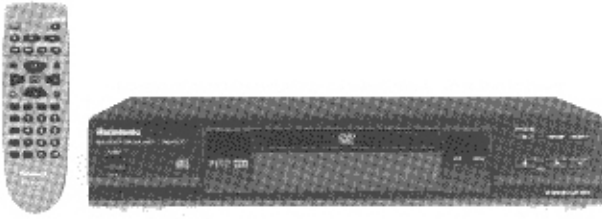

The photographs show DVD-RV30.
DVD-RV20 and DVD-RV10 are only for U.S.A.

Model No. **DVD-RV30**
DVD-RV20
DVD-RV10



Before connecting, operating or adjusting this product, please read these instructions completely.
Please keep this manual for future reference.

U CA PX



This manual was printed with soy based ink.

VQT8429

Dear Customer

Thank you for purchasing this product.
For optimum performance and safety, please read these instructions carefully.

These operating instructions are applicable to models DVD-RV30, DVD-RV20 and DVD-RV10.

These operating instructions, however, are intended primarily for model DVD-RV30.

DVD-RV30: indicates features applicable to DVD-RV30 only.

DVD-RV20: DVD-RV20 only.

DVD-RV10: DVD-RV10 only.

Getting Started

Accessories



Please check and identify the supplied accessories.
Use numbers indicated in parentheses when asking for replacement parts.

(Only for U.S.A.)

To order accessories, call PASC Accessory Dept.

1-800-332-5368 or web site (<http://www.panasonic.com>).

(Only for Canada)

To order accessories, call the dealer from whom you have made your purchase.



Remote control 1
(VEQ2378)

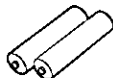

Batteries 2
for remote control

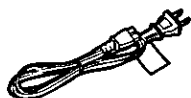

AC power supply cord 1
(DVD-RV30)
For U.S.A.: VJA1094 or VJA1095
For Canada: VJA0663 or VJA1095
For others: VJA0664-1
(DVD-RV20) **(DVD-RV10)**: VJA1094)

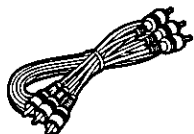

Audio/video cable 1
(VJA1062 or VJA0788-D)



For units sold outside U.S.A. and Canada
 Power plug adaptor 1
(VJP2974)

Optional accessories

S video cable (⇒ page 9.)

Optical digital audio cable (⇒ pages 32 and 33.)

Note

• The included AC power supply cord is for use with this unit only. Do not use it with other equipment.

User memo:

DATE OF PURCHASE _____
DEALER NAME _____
DEALER ADDRESS _____
TELEPHONE NUMBER _____

The model number and serial number of this product can be found on either the back or the bottom of the unit.
Please note them in the space provided below and keep for future reference.

MODEL NUMBER _____

SERIAL NUMBER _____

Table of contents

Getting Started

Accessories	2
SAFETY INFORMATION	3
PRECAUTIONS	4
Remote control preparations	5
Disc information	6
Control reference guide	7
Connection to a television	8

Basic Operations

Basic play	11
Stopping play	12
Other methods of play	13
Still picture (Pause)	13
Skipping chapters or tracks	13
Frame advance (Frame reverse)	13
Slow-motion play	14
Rapid advance (Rapid reverse)	14
Canceling playback control	15
Using menus to play	15

Advanced Operations

Advanced operations	16
Changing soundtrack language	16
Changing subtitle language	17
Viewing from another angle	17
Reproducing an Advanced Virtual Surround Sound (V.S.S.) effect	18
Changing picture quality for movie viewing (DVD-RV30)	18
Repeat play	19
Program play	20
Random play	20
Using On-Screen Menu Icons	21
Common procedures	21
Detailed descriptions of each icon	22
Changing initial settings	24
Common procedures	24
1 Disc Languages	25
2 Ratings	26
3 Menu Language	27
4 On-Screen Messages	27
5 FL Display	27
9 Other Settings	28
How different kinds of software appear on your television	29

Home Theater

Home Theater	30
Connecting a subwoofer (DVD-RV30)	31
Connecting audio equipment with 2-channel audio input terminals	31
Connecting an amplifier with a built-in decoder	32
Connecting audio equipment with digital audio input terminals	33
Selecting digital output	34

For Your Reference

Troubleshooting	36
Disc handling	38
Product Service	38
Maintenance	38
Servicenter List (US)	39
Specifications	Back cover

SAFETY INFORMATION

Note

Use this player only in areas with the same power supply.
Units for the U.S.A. and Canada: AC 120 V, 60 Hz.
Units for other areas: AC 110–240 V, 50/60 Hz. (Refer also to page 8, "CAUTION FOR CONNECTING AC POWER SUPPLY CORD".)

CAUTION:

DVD/VIDEO CD/CD PLAYER IS A CLASS I LASER PRODUCT. HOWEVER THIS DVD/VIDEO CD/CD PLAYER USES A VISIBLE LASER BEAM WHICH COULD CAUSE HAZARDOUS RADIATION EXPOSURE IF DIRECTED. BE SURE TO OPERATE THE DVD/VIDEO CD/CD PLAYER CORRECTLY AS INSTRUCTED.

WHEN THIS DVD/VIDEO CD/CD PLAYER IS PLUGGED TO THE WALL OUTLET, DO NOT PLACE YOUR EYES CLOSE TO THE OPENING OF THE DISC TRAY AND OTHER OPENINGS TO LOOK INTO THE INSIDE OF THIS PLAYER.

USE OF CONTROLS OR ADJUSTMENTS OR PERFORMANCE OF PROCEDURES OTHER THAN THOSE SPECIFIED HEREIN MAY RESULT IN HAZARDOUS RADIATION EXPOSURE.

DO NOT OPEN COVERS AND DO NOT REPAIR YOURSELF. REFER SERVICING TO QUALIFIED PERSONNEL.

WARNING:

TO REDUCE THE RISK OF FIRE OR ELECTRIC SHOCK, DO NOT EXPOSE THIS PLAYER TO RAIN OR MOISTURE.

TO REDUCE THE RISK OF FIRE OR ELECTRIC SHOCK, AND ANNOYING INTERFERENCE, USE THE RECOMMENDED ACCESSORIES ONLY.

THIS PLAYER IS INTENDED FOR CONTINUOUS OPERATION!

CAUTION:

TO PREVENT ELECTRIC SHOCK, DO NOT USE THIS (POLARIZED) PLUG WITH AN EXTENSION CORD, RECEPTACLE OR OTHER OUTLET UNLESS THE BLADES CAN BE FULLY INSERTED TO PREVENT BLADE EXPOSURE.

CAUTION	-LASER RADIATION WHEN OPEN. DO NOT STARE INTO BEAM.
ATTENTION	-RAYONNEMENT LASER EN CAS D'OUVERTURE. NE PAS REGARDER DANS LE FAISCEAU.
VORSICHT	-LASERSTRAHLUNG, WENN ABDECKUNG GEÖFFNET. NICHT IN DEN STRAHL BLICKEN.
ADVARSEL	-LASERSTRÅLING VED ÅBNING. SE IKKE IND I STRÅLEN.
ADVARSEL	-LASERSTRÅLING NÅR DEKSEL ÅPNES. STIRR IKKE INN I STRÅLEN.
VARNING	-LASERSTRÅLNING NÅR DENNA DEL ÅR ÖPPNAD. STIRRA EJ IN I STRÅLEN.
VARO!	-AVATTAESSA OLET ALTTIINA LASERSÄTEILYLLE. ÄLÄ TUJOTA SÄTEESEEN.
注意	- 当打开这里会出现激光, 请不要直视激光。
注意	- ここを開くとレーザー光が出ます。 レーザー光をのぞきまなないでください。

(Inside of player)

FCC NOTE: (U.S.A. Only)

This equipment has been tested and found to comply with the limits for a Class B digital device, pursuant to Part 15 of the FCC Rules. These limits are designed to provide reasonable protection against harmful interference in a residential installation. This equipment generates, uses and can radiate radio frequency energy and, if not installed and used in accordance with the instructions, may cause harmful interference to radio communications. However, there is no guarantee that interference will not occur in a particular installation. If this equipment does cause harmful interference to radio or television reception, which can be determined by turning the equipment off and on, the user is encouraged to try to correct the interference by one or more of the following measures:

- Reorient or relocate the receiving antenna.
- Increase the separation between the equipment and receiver.
- Connect the equipment into an outlet on a circuit different from that to which the receiver is connected.
- Consult the dealer or an experienced radio/TV technician for help.

FCC Caution: To assure continued compliance, follow the attached installation instructions and use only shielded cables when connecting to other devices. Also, any changes or modifications not expressly approved by the party responsible for compliance could void the user's authority to operate this equipment.



CAUTION
RISK OF ELECTRIC SHOCK
DO NOT OPEN



CAUTION: TO REDUCE THE RISK OF ELECTRIC SHOCK, DO NOT REMOVE COVER (OR BACK). NO USER-SERVICEABLE PARTS INSIDE. REFER SERVICING TO QUALIFIED SERVICE PERSONNEL.



The lightning flash with arrowhead symbol, within an equilateral triangle, is intended to alert the user to the presence of uninsulated "dangerous voltage" within the product's enclosure that may be of sufficient magnitude to constitute a risk of electric shock to persons.



The exclamation point within an equilateral triangle is intended to alert the user to the presence of important operating and maintenance (servicing) instructions in the literature accompanying the appliance.

For units sold outside U.S.A. and Canada

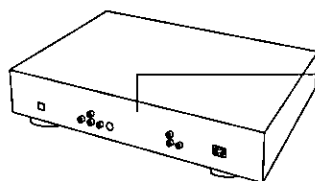

(Back of player)



PRECAUTIONS

Before using this unit please read these operating instructions carefully. Take special care to follow the warnings indicated on the unit itself as well as the safety suggestions listed below. Afterwards keep them handy for future reference.

Safety

1. **Power Source**—The unit should be connected to power supply only of the type described in the operating instructions or as marked on the unit.
2. **Polarization**—If the unit is equipped with a polarized AC power plug (a plug having one blade wider than the other), that plug will fit into the AC outlet only one way. This is a safety feature. If you are unable to insert the plug fully into the outlet, try reversing the plug. If the plug should still fail to fit, contact your electrician to replace your obsolete outlet. Do not defeat the safety purpose of the polarized plug.
3. **Power Cord Protection**—AC power supply cords should be routed so that they are not likely to be walked on or pinched by items placed upon or against them. Never take hold of the plug or cord if your hand is wet, and always grasp the plug body when connecting or disconnecting it.
4. **Nonuse Periods**—When the unit is not used, turn the power off. When left unused for a long period of time, the unit should be unplugged from the household AC outlet.

Installation

Environment

1. **Water and Moisture**—Do not use this unit near water—for example, near a bathtub, washbowl, swimming pool, or the like. Damp basements should also be avoided.
2. **Condensation**—Moisture may form on the lens in the following conditions...
 - immediately after a heater has been turned on.
 - in a steamy or very humid room.
 - when the unit is suddenly moved from a cold environment to a warm one.If moisture forms inside this unit, it may not operate properly. To correct this problem, turn on the power and wait about one hour for the moisture to evaporate.
3. **Heat**—The unit should be situated away from heat sources such as radiators and the like. It also should not be placed in temperatures less than 5°C (41°F) or greater than 35°C (95°F).

Placement

1. **Ventilation**—The unit should be situated so that its location or position does not interfere with its proper ventilation. Allow 10 cm (4") clearance from the rear of the unit.
2. **Foreign Material**—Care should be taken so that objects do not fall into and liquids are not spilled into the unit. Do not subject this unit to excessive smoke, dust, mechanical vibration, or shock.
3. **Magnetism**—The unit should be situated away from equipment or devices that generate strong magnetic fields.
4. **Stacking**—Do not place heavy objects, other than system components, on top of the unit.
5. **Surface**—Place the unit on a flat, level surface.
6. **Carts and Stands**—The unit should be used only with a cart or stand that is recommended by the manufacturer. The unit and cart combination should be moved with care. Quick stops, excessive force, and uneven surfaces may cause the unit and cart combination to overturn.
7. **Wall or Ceiling Mounting**—The unit should not be mounted to a wall or ceiling, unless specified in this operating instructions.



Maintenance

Clean the cabinet, panel and controls with a soft cloth lightly moistened with mild detergent solution.

Do not use any type of abrasive pad, scouring powder or solvent such as alcohol or benzene.

Service

1. **Damage Requiring Service**—The unit should be serviced by qualified service personnel when:
 - (a) The AC power supply cord or the plug has been damaged; or
 - (b) Objects have fallen or liquid has been spilled into the unit; or
 - (c) The unit has been exposed to rain; or
 - (d) The unit does not appear to operate normally or exhibits a marked change in performance; or
 - (e) The unit has been dropped, or the enclosure damaged.
2. **Servicing**—The user should not attempt to service the unit beyond that described in the operating instructions. All other servicing should be referred to an authorized service personnel.

For the address of an authorized servicer:
In the U.S.A. 1-800-211-7262 or web site
(<http://www.panasonic.com>)
In Canada 905-624-5505 or web site
(www.panasonic.ca)

Remote control preparations

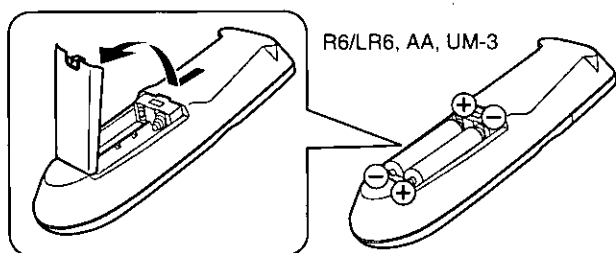
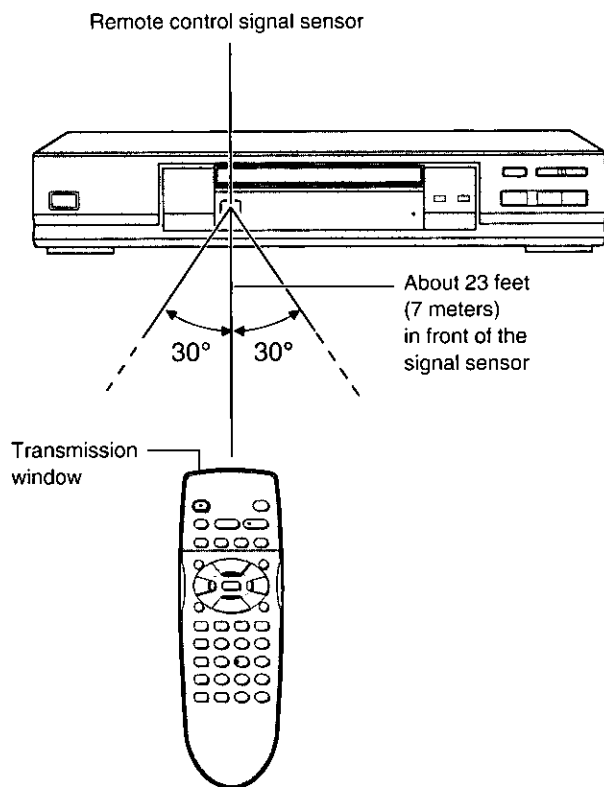
A**B**

A Battery installation

Use of batteries

- Align the poles (+ and -) properly when inserting the batteries.
- Do not mix old and new batteries or different types of batteries.
- Do not recharge ordinary dry cell batteries.
- Do not heat or disassemble the batteries. Do not allow them to contact flame or water.
- Remove the batteries if the unit is not to be used for a long time.
- Do not keep together with metallic objects such as necklaces.
- Do not use rechargeable type batteries.
- Do not use batteries if the covering has been peeled off.

Mishandling of batteries can cause electrolyte leakage which can damage items the fluid contacts and may cause a fire. If electrolyte leaks from the batteries, consult your dealer. Wash thoroughly with water if electrolyte comes in contact with any part of your body.





B Correct method of use

Operation notes

- Do not place obstacles between the remote control signal sensor and remote control unit.
- Do not expose the remote control signal sensor to direct sunlight or to the bright light of a fluorescent light.
- Take care to keep the remote control signal sensor and end of the remote control unit free from dust.
- If this system is installed in a rack with glass doors, the glass doors' thickness or color might make it necessary to use the remote control a shorter distance from the system.

To prevent damage

- Never place heavy items on top of the unit.
- Do not disassemble or reconstruct the unit.
- Do not spill water or other liquids into the unit.

 Discs supported by this player	 Discs not supported by this player
DVD-Video  3" (8 cm) disc/ 5" (12 cm) disc	<ul style="list-style-type: none"> • Do not try to play Photo CD or CD-R. (Data on the disc may be damaged.) • DVD with region number other than "1" or "ALL" • PAL discs • DVD-ROM • DVD-R/DVD-RAM • CD-ROM • SACD etc. <ul style="list-style-type: none"> • CD-G • CD-RW • DVD+RW • CVD • VSD <ul style="list-style-type: none"> • Divx Video Disc • DVD-Audio • DVD-RW • SVCD • CDV
Video CD  3" (8 cm) disc/ 5" (12 cm) disc	
Audio CD  3" (8 cm) disc/ 5" (12 cm) disc	

For the purpose of these operating instructions "DVD" stands for DVD-Video and "CD" stands for Audio CD.

Region number supported by this player

Region numbers are allocated to DVD players and software according to where they are sold.

- The region number of this player is "1".
- The player will play DVDs marked with labels containing the region number "1" or "ALL".

Example:



etc.

Playing DVD and Video CDs

The producer of the material can control how these discs are played. This means that you may not be able to control play of a disc with some operations described in these operating instructions. Read the disc's instructions carefully.

- Example:**
- "⏪" appears when you press the skip buttons to move to the next section.
 - Resume, repeat play, and markers may not work during play of interactive DVDs and menu play of Video CDs with playback control.
 - After showing the Karaoke menu, tracks are played successively without returning to the menu (Video CD with playback control).

Marks used in these operating instructions

DVD: indicates features applicable to DVD only.

VCD: Video CD only.

CD: CD only.

Terms used in these operating instructions

Title/Chapter **DVD**

DVDs are divided up into large sections, titles, and smaller sections, chapters. The numbers allocated to these sections are called title numbers and chapter numbers.

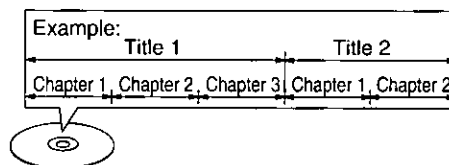

Track **VCD** **CD**

Video CDs and CDs are divided up into sections called tracks, and the numbers allocated to these sections are called track numbers.

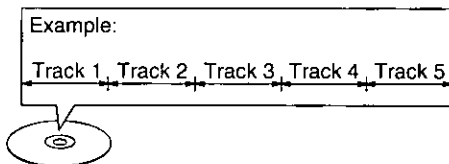

Playback control **VCD**

If a Video CD has "playback control" written on its disc or jacket, it means that particular scenes or information can be selected for viewing interactively with the TV monitor using the menu screen. This player can play Video CDs with playback control. Using menus to control play of a Video CD is called "menu play" in these operating instructions.

Display during play of a Video CD with playback control

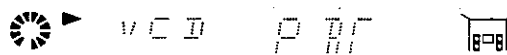

Interactive DVD **DVD**

An interactive DVD is DVD software which includes multiple angles, multiple plot endings, etc. The elapsed play time of these DVDs is not shown.

Display during play of an interactive DVD

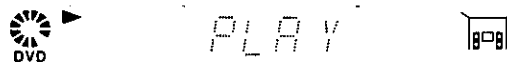

Control reference guide

DVD-RV30

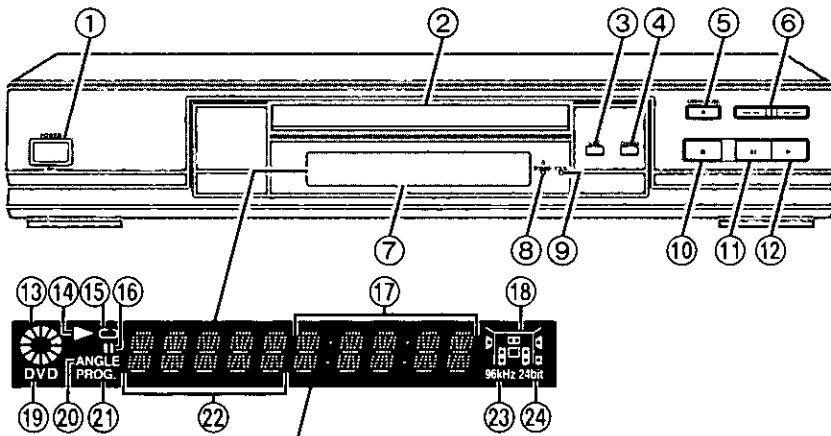

DVD-RV20 DVD-RV10

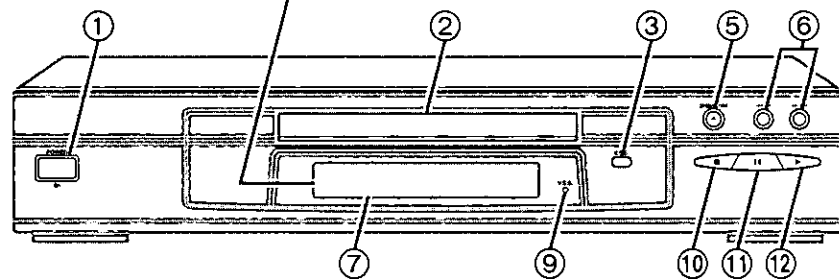

Buttons such as ❶ function in exactly the same way as the buttons on the player.

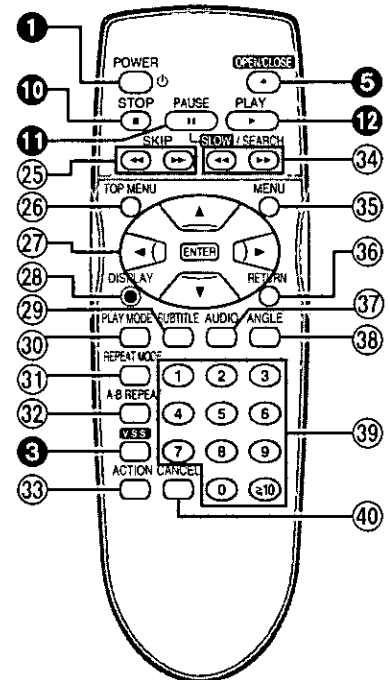

Getting Started

Player

	Page
❶ Power button (POWER \odot/I)	11
Press to switch the unit from on to standby mode or vice versa. In standby mode, the unit is still consuming a small amount of power.	
❷ Disc tray	11
❸ Virtual Surround Sound button (V.S.S.)	18
❹ DVD-RV30 Cinema button (CINEMA)	18
❺ Disc tray open/close button (\blacktriangle OPEN/CLOSE)	11
❻ Skip/Search button ($\lll/\lll, \ggg/\ggg$)	13
❼ FL display	
❽ For units sold outside U.S.A. and Canada STANDBY indicator (\odot STANDBY)	
When the unit is connected to the AC power supply, this indicator lights up in standby mode and goes out when the unit is turned on.	
❾ Virtual Surround Sound indicator (V.S.S.)	18
❿ Stop button (\blacksquare)	12
⓫ Pause button (II)	13
⓬ Play button (\blacktriangleright)	11
⓭ Rotates during play. Rotates fast clockwise or counterclockwise during rapid advance (reverse). Rotates slowly clockwise or counterclockwise during slow-motion play. [DVD] [VCD]	
⓮ Illuminates in the stop mode.	
⓯ Illuminates during playback. Flashes when the RESUME function is ON.	
⓰ Illuminates during repeat play.	
⓱ Illuminates in the still picture (pause) mode.	
⓲ Elapsed playing time from the start of the title/track during play	
⓳ Audio channel information recorded in the disc being played back (e.g. 2ch or 5.1ch)	

- ⓴ A DVD is loaded.
- ⓵ It is possible to switch the angle. [DVD]
- ⓶ Illuminates during program play. [VCD] [CD]
- ⓷ Title/chapter number [DVD]
Track number [VCD] [CD]
- ⓸ Linear PCM of 96 kHz sampling is being played.
- ⓹ Linear PCM of 24 bit is being played.

Remote control

	Page
⓴ Skip buttons (\lll, \ggg SKIP)	13
⓵ Top menu button (TOP MENU)	11
⓶ Cursor buttons ($\blacktriangle, \blacktriangledown, \blacktriangleleft, \blacktriangleright$)/Enter button (ENTER)	11
⓷ Display button (\bullet DISPLAY)	21
⓸ Subtitle button (SUBTITLE)	17
⓹ Play mode button (PLAY MODE)	20
⓺ Repeat mode button (REPEAT MODE)	19
⓻ A-B repeat button (A-B REPEAT)	19
⓼ Action button (ACTION)	24
⓽ Slow/Search buttons (\lll, \ggg SLOW/SEARCH)	14
⓾ Menu button (MENU)	11
⓿ Return button (RETURN)	11
⓿ Audio button (AUDIO)	16
⓿ Angle button (ANGLE)	17
⓿ Numeric buttons (1-9, 0, ≥ 10) • To select a 2-digit number Example: To select track 23 Press [≥ 10], then [2] and [3].	11
⓿ Cancel button (CANCEL)	20

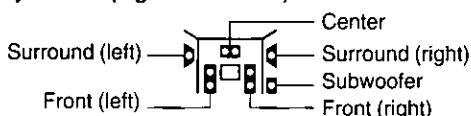

Connection to a television

- Ensure that this player and other equipment to be connected are switched to the standby mode or off and disconnect the AC power supply cord before commencing connection.
- Do not block ventilation holes of any of the equipment and arrange them so that air can circulate freely.
- Read through the instructions before connecting other equipment.
- Ensure that you observe the color coding when connecting audio and video cables.
- See page 30 for information about how to upgrade your system with other audio/visual equipment.

Note

- Peripheral equipment and optional cables sold separately unless otherwise indicated.
- TV volume may be lower when playing DVDs than during television broadcasts. Turn the volume up while playing DVDs and reduce it to the previous level **before** switching the source back to television to avoid sudden changes in volume.
- When you have finished connection, select the appropriate screen type at the initial setting "6 TV Aspect" according to your television (4:3/16:9). (→ page 10.) No changes are needed if you connect the player to a standard 4:3 aspect, direct-view television.

Conserving power

- The unit consumes 2.0 W (for U.S.A. and Canada) even when it is turned off with [POWER ⏻/I]. To save power when the unit is not to be used for a long time, unplug it from the household AC outlet.

Connect Your Player Directly To Your Television.

If the player is connected to the television through a video cassette recorder, the picture may not be played back correctly due to the copy guard. So we strongly recommend you do not connect the player to your video cassette recorder when setting up your home entertainment system.

- Connect to the television section if you connect the player to a combined television-video player.

Do not place the player on amplifiers or other equipment which may become hot.

The heat can damage the player.

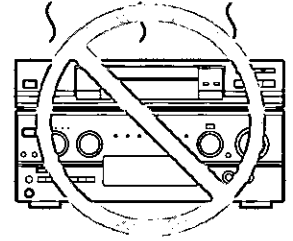

Connecting to a television with video input terminal

These figures show DVD-RV30.

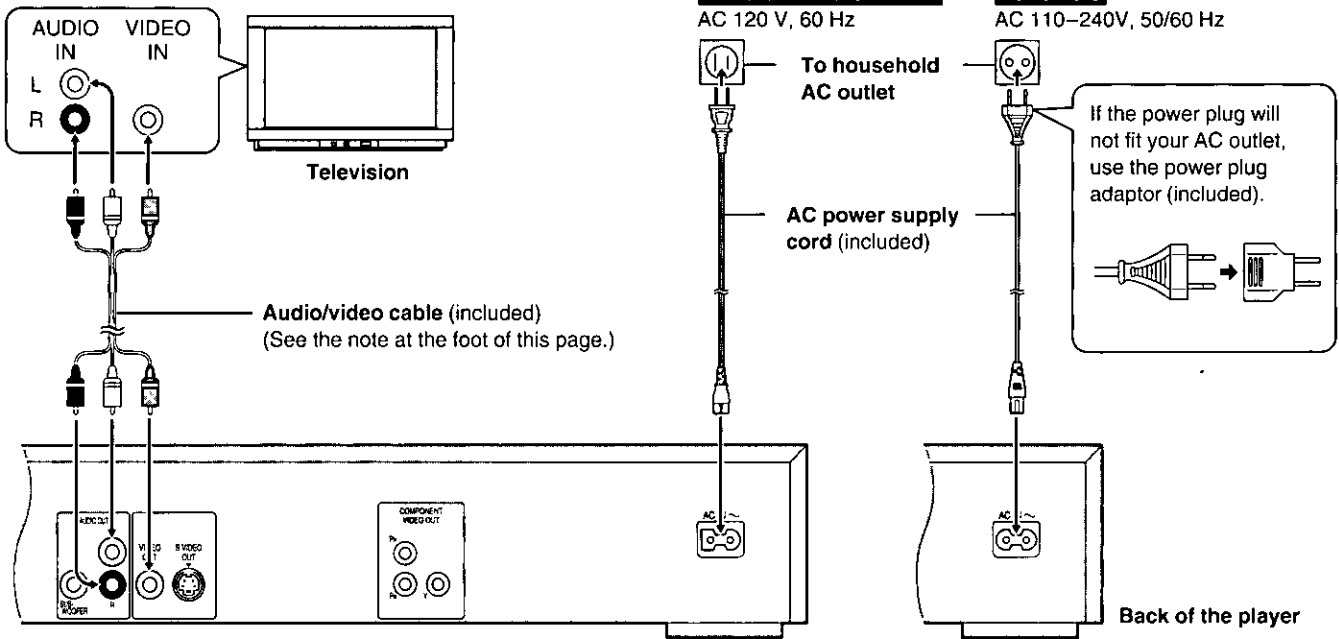

For units sold outside U.S.A. and CANADA

CAUTION FOR CONNECTING AC POWER SUPPLY CORD:

- For connection to a supply in the U.S.A., the provided AC power supply cord must be connected to 120 V AC supply only with the power plug adaptor (included).
- Confirm the voltage in each country before using this player.
- For connection, use a power plug adaptor of the proper configuration for the household AC outlet.
- Contact either a local or foreign electrical parts distributor for assistance in selecting a power plug adaptor or a proper AC power supply cord set.

Note

- If your television is monaural, use a stereo-monaural audio cable instead of the supplied audio/video cable. The video part of the cable (yellow) can still be used if required.

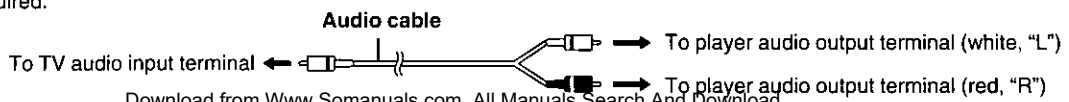

Connecting to a television with S video input terminal

These figures show DVD-RV30.

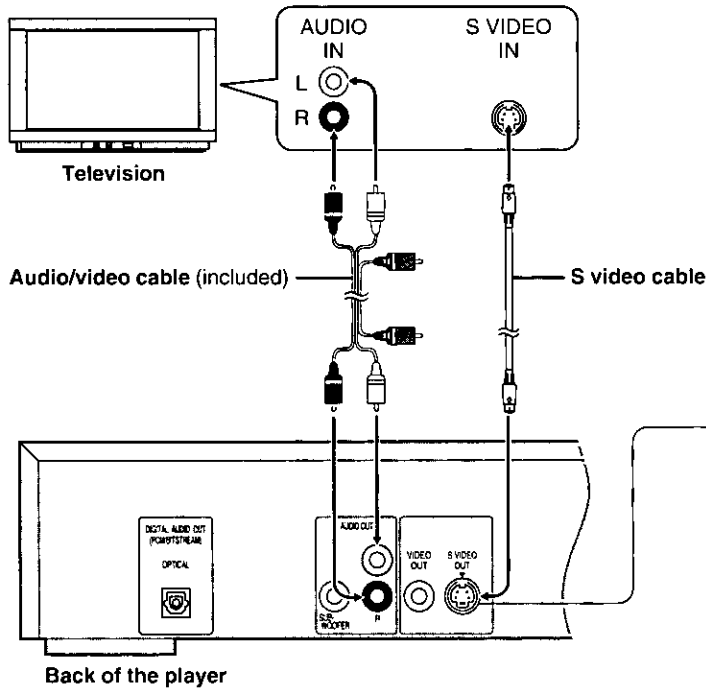

S video output terminal

The S (separate) video output terminal achieves a more vivid picture than the video output terminal by separating the color (C) and luminance (Y) signals before transmitting them to the television. (Actual results depend on the television.)

Connecting to a television with component video input terminals DVD-RV30

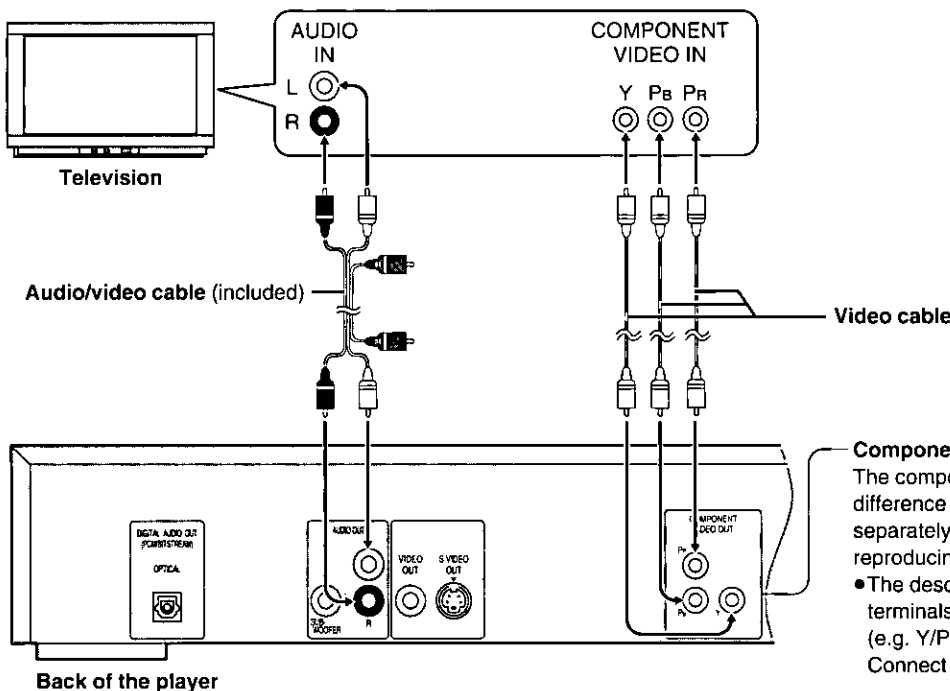

Component video output terminals (Y/P_B/P_R)

The component video output terminal outputs the color difference signals (P_B/P_R) and luminance signal (Y) separately in order to achieve high fidelity in reproducing colors.

- The description of the component video input terminals depends on the television or monitor (e.g. Y/P_B/P_R, Y/B-Y/R-Y, Y/C_B/C_R and so on). Connect to terminals of the same color.

Selecting TV screen type

Select the TV aspect, conventional size screen (4:3) or wide-screen (16:9) according to your television.

Preparation

- Switch the video input mode on the television to suit the type of connection you have made (e.g., VCR 2).

- 1 Press [POWER] to switch on the power.**
- 2 Press [ACTION] in the stop mode.**
The initial settings screen is displayed.
- 3 Press the cursor buttons [▲, ▼] to select "6 TV Aspect" and press [ENTER].**
- 4 Press the cursor buttons [▲, ▼] to select the TV aspect and press [ENTER].**

- 1 4:3:**
Select when a conventional television is connected.
(Factory preset)
- 2 16:9:**
Select when a wide-screen television is connected.

Setting is finished and the initial settings screen in step 2 is displayed.

To cancel during setup operation

Press [RETURN]. (The previous screen is displayed.)

To clear the initial settings screen

Press [ACTION] or [RETURN].

For your reference

- For further details on the images which appear on the TV screen, see page 29.
- The optimum settings for your television may differ to those shown above.

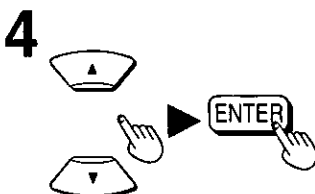
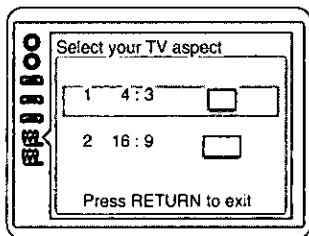
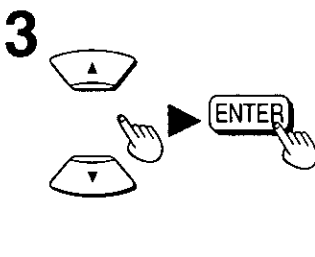
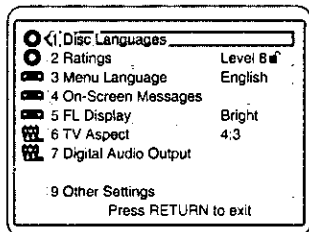
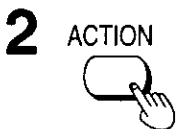
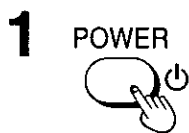
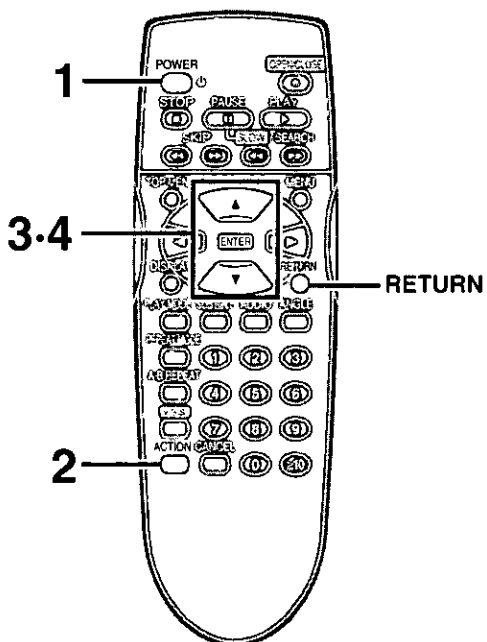

Basic play

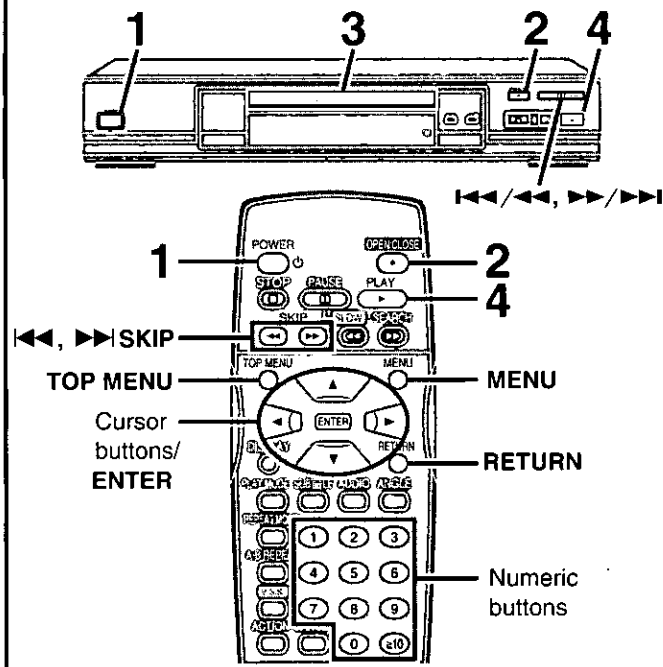

■ Before enjoying DVD/Video CD/CD

The menu language for this player has been set to English, but you can change the language to French or Spanish (→ "3 Menu Language", page 27). English has been used in the examples shown.

Preparations

- Ensure connections to your television and audio equipment are correct.
- Turn on your television and other equipment.
- Switch the video input mode on the television to suit the type of connection you have made (e.g., VCR 2).

1 Press [POWER \odot /I] to switch on the power.

2 Press [\blacktriangle OPEN/CLOSE] to open the disc tray.

3 Place the disc on the disc tray.
 • Insert inside the guides.
 • Do not load more than one disc.

4 Press [▶].
 The disc tray is automatically closed and play begins.

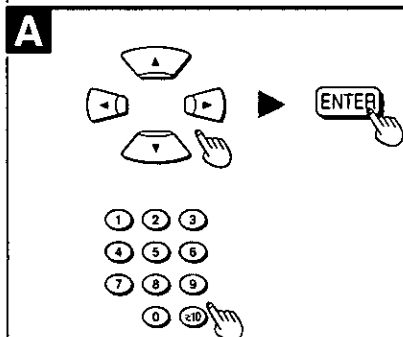
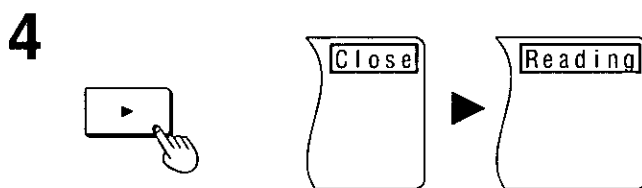
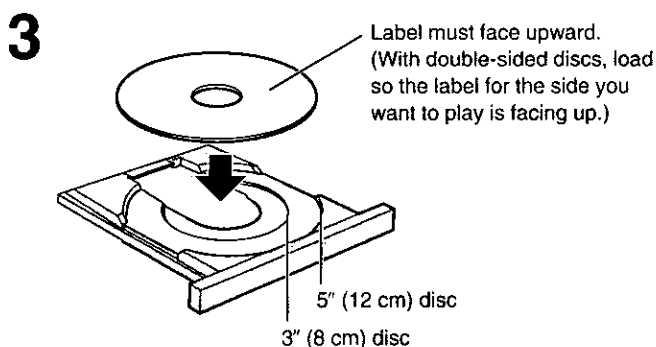
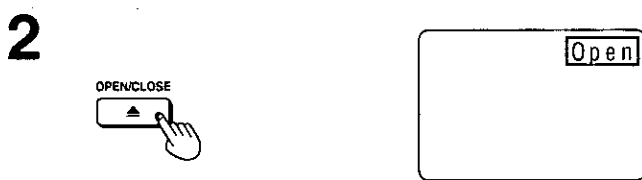
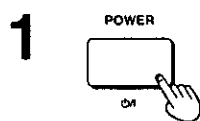

A When a menu screen appears on the TV monitor

Press the cursor buttons [\blacktriangle , \blacktriangledown , \blacktriangleleft , \blacktriangleright] and press [ENTER], or press the numeric buttons, to select the item.

Play of the selected item now begins.

- The cursor buttons are not effective for selecting items for Video CDs.

■ Other buttons used to operate menus

The operation of these buttons differs with the disc so read the instructions that came with the disc for further details.

[▶▶/▶▶], [▶▶ SKIP]: Shows the next menu.

[◀◀/◀◀], [◀◀ SKIP]: Shows the previous menu.

[RETURN]: Shows the menu screen.

[TOP MENU]: Shows the first menu screen. [DVD]

[MENU]: Shows the menu screen. [DVD]

Note

- "NO PLAY" is displayed on the FL display if you load the following kinds of discs and they cannot be played:
 - DVD for which playback is prohibited by the initial settings "2 Ratings". (→ page 26.)
 - DVD with Region No. other than "1" or "ALL". (→ page 6.)
 - If the disc is put in upside down (and it is a single sided disc).
- When "⊘" appears on the TV monitor when a button is pressed, the operation is prohibited by the player or disc.

POWER

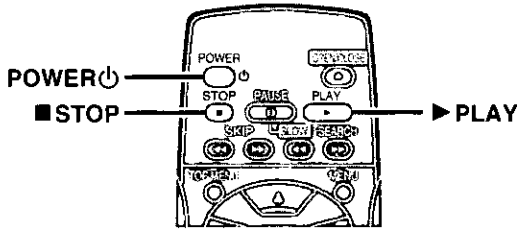
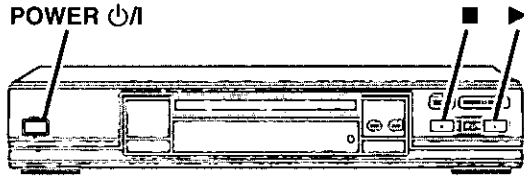

Basic play

A Stopping play

Press [■] during play.

- The player records the point where [■] was pressed during play. ("▶" flashes on the player's FL display when this function is activated.)

B To resume play from where you stopped it (RESUME function)

Press [▶] while "▶" is flashing.

Play will resume from the point where [■] was pressed.

To clear the RESUME function

Press [■] again or open the disc tray while "▶" is flashing.

Note

- The RESUME function works only with titles for which the elapsed playing time appears on the player's FL display during playback.
- This feature remains active if the player is switched to the standby mode and then turned back ON.

C Chapter preview function

DVD

This function plays the first few seconds of each chapter from the beginning of the title up to the point where operation was stopped. This makes it possible to review previous chapters.

1. Press [▶] while "▶" is flashing.

(The message illustrated is briefly displayed.)

2. Press [▶] again while the message is displayed on the screen.

Normal playback will commence from the point where operation was stopped.

Note

- Cancelling the RESUME function will also clear the chapter preview function.
- The chapter preview function may not work with some DVDs.

■ After operation

When the player is not in use, remove the disc and press [POWER] to switch the player to the standby mode.

The player is automatically switched to the standby mode after 30 minutes or so have elapsed in the stop mode.

(Auto power-off function)

Note

- The disc continues to rotate while the menu is displayed even after the player has finished playing a particular item. Stop the player when you finish viewing to preserve the player's motor and prevent screen burn.

A

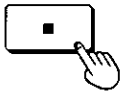

B



C

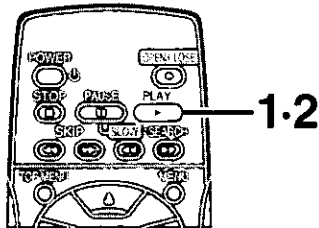
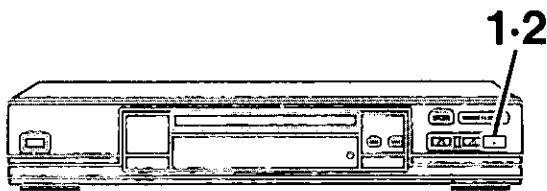

1

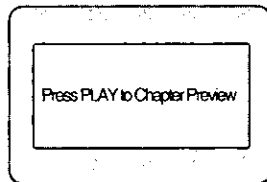

2

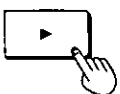

Other methods of play

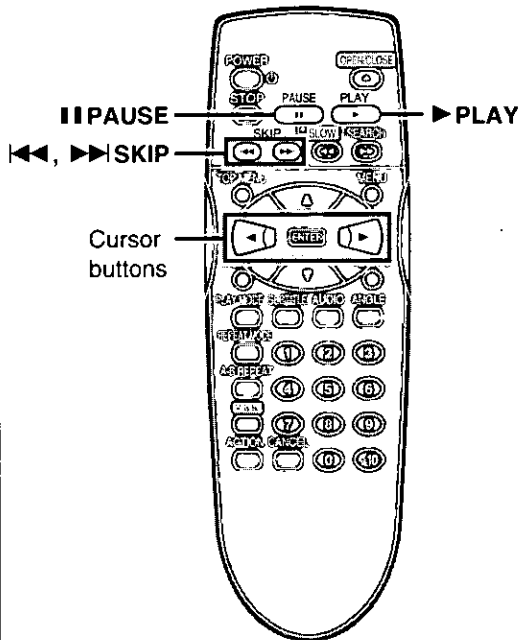
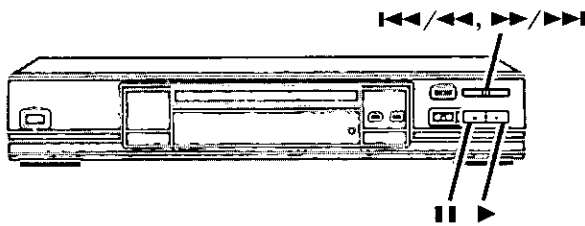

Features from here on are accessed mainly by using the remote control.

A Still picture (Pause)

Press [**II PAUSE**] during play.

To return to normal play
Press [**▶ PLAY**].

B Skipping chapters or tracks

Press [**◀◀, ▶▶ SKIP**] during play or while paused.

On the Player

Press [**◀◀/◀◀, ▶▶/▶▶**] during play or while paused.

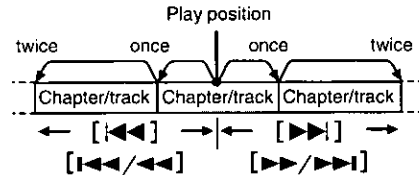

A

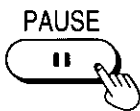

B

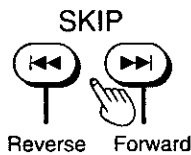

C

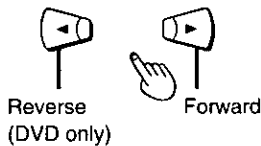

For your reference

- When [**◀◀, ▶▶ SKIP**] or [**◀◀/◀◀, ▶▶/▶▶**] on the player is pressed during menu play of Video CDs with playback control, a menu screen may sometimes be recalled.

C Frame advance (Frame reverse)

DVD VCD

Press the cursor buttons [**◀, ▶**] while paused.

- The disc is advanced (reversed) by one frame each time the cursor buttons [**◀, ▶**] are pressed.
- When the cursor buttons [**◀, ▶**] are kept pressed, consecutive frame advance (reverse) works.

To return to normal play

Press [**▶ PLAY**].

For your reference

- Pressing [**II PAUSE**] also activates frame advance.
- Whether the pictures are advanced by a "Frame" or "Field" is automatic, but you can change the initial settings to choose how the picture is advanced. (→ page 28.)

Other methods of play

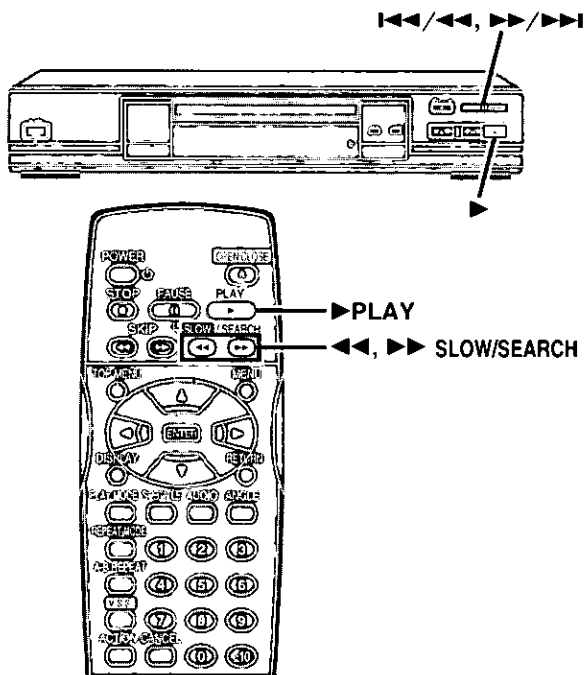

A Slow-motion play

DVD VCD
 Press [**◀◀, ▶▶ SLOW/SEARCH**] while **paused**. (→ page 13.)
 •Each press increases the speed of slow-motion.

On the Player
 Press and hold [**◀◀/◀◀, ▶▶/▶▶**] while **paused**. (→ page 13.)
 •The slow-motion speed increases if the button is held down.

•There are five speeds of slow-motion.

To return to normal play
 Press [**▶ PLAY**].

For your reference
 •When [**◀◀, ▶▶ SLOW/SEARCH**] or [**◀◀/◀◀, ▶▶/▶▶**] on the player is pressed during menu play of Video CDs with playback control, a menu screen may sometimes be recalled.

A

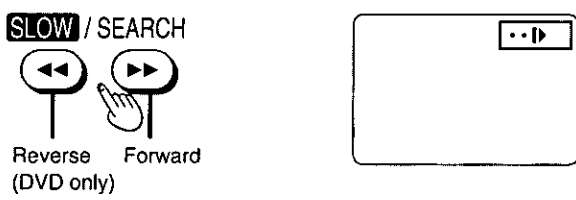

B Rapid advance (Rapid reverse)

Press [**◀◀, ▶▶ SLOW/SEARCH**] during **play**.
 •Each press increases the speed of the search.

On the Player
 Press and hold [**◀◀/◀◀, ▶▶/▶▶**] during **play**.
 •The search speed increases if the button is held down.

•There are five speeds of advance (reverse).

To return to normal play
 Press [**▶ PLAY**].

For your reference
 •When [**◀◀, ▶▶ SLOW/SEARCH**] or [**◀◀/◀◀, ▶▶/▶▶**] on the player is pressed during menu play of Video CDs with playback control, a menu screen may sometimes be recalled.
 •For DVDs and Video CDs, audio will be heard during searching (forward direction only) at the initial search speed. (To turn audio off, see "2 Audio during Search" on page 28.)

B

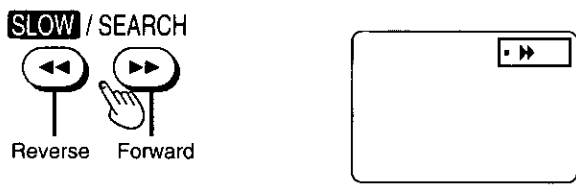

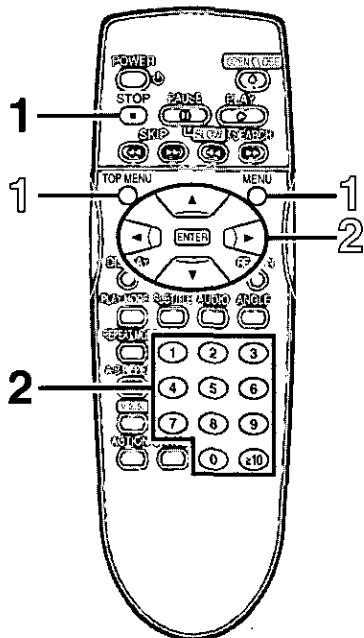

A Canceling playback control

VCD

1 Press [■ STOP] after the menu screen appears (after step 4 on page 11).
 "PBC" will be cleared from the player's FL display.

2 Press the numeric buttons to select a track. (→ item ⑨ on page 7 for number entry.)
 Play begins.
 • Refer to the jacket etc. of the disc concerned for the track numbers.
 • Press [1] to start play from the beginning of the disc.

To return to menu play

Press [■ STOP] to stop play, press [MENU], and press the numeric buttons to select an item.
 "PBC" lights on the player's FL display.

B Using menus to play

DVD

By calling up menus during play, you can start play from a specific title or chapter, or change the soundtrack and subtitle languages.

1 Press [TOP MENU] or [MENU] during play to display the menu.

2 Press the cursor button [▲, ▼, ◀, ▶] to select an item and press [ENTER].
 The selected item is confirmed.
 • Repeat if other menus are shown.

DVDs can have several menus. The menu displayed when you press [TOP MENU] may be different to the menu displayed when you press [MENU] (■).

For your reference

- Menu content depends on the disc. These operating instructions describe the basic steps.
- Both buttons take you to the same menu if the disc has only one menu.

A



2

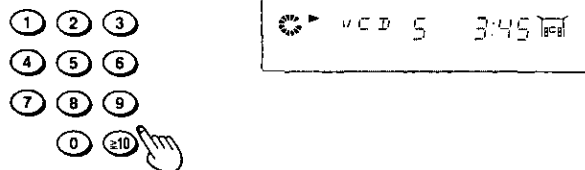

B



2

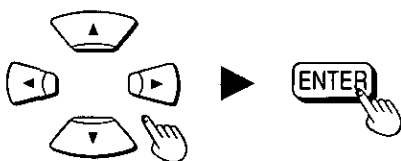

C

Example: if you press the buttons while you are playing title 2

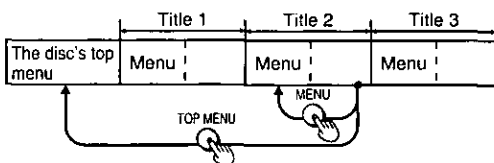

Advanced operations

A

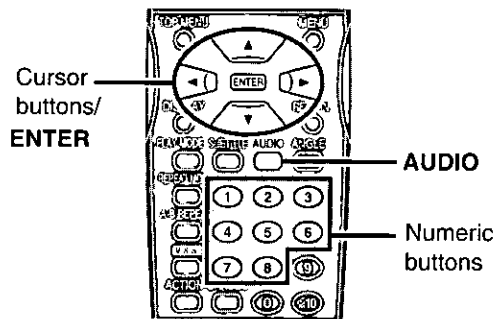

AUDIO



Soundtrack language number being played back ("—" indicates a soundtrack is not recorded.)

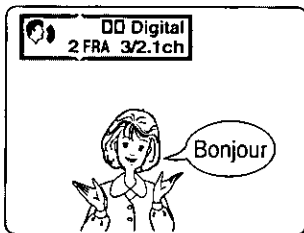
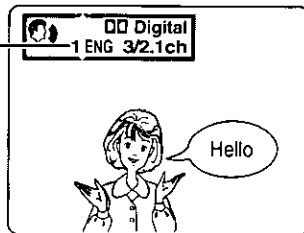

B

2 ENTER

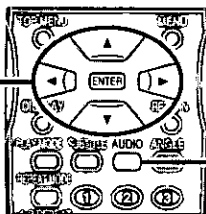

1.2

1

AUDIO



2

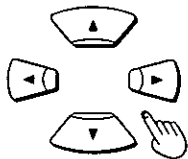

DVD

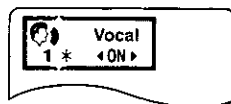

Video CD



AUDIO



A Changing soundtrack language

DVD

Some DVDs have more than one soundtrack language recorded on them, and you can change soundtrack language during play.

Press [AUDIO] during play to display the current language number.

The number changes each time you press the button.

- You can also use the cursor buttons [▲, ▼] or the numeric buttons to change the language number.

To clear the display

Press [ENTER].

For your reference

- You can only select languages or sound formats if they have been recorded on the disc you are playing.
- If resume (⇨ page 12) is canceled or if you stop play of an interactive DVD, the soundtrack languages revert to the initial settings. (⇨ page 25.)
- Some discs allow changes to soundtrack languages only by using the disc's menus.

B Switching vocals ON or OFF for Karaoke discs

DVD VCD

1. Press [AUDIO] during play.
2. Press the cursor buttons [▲, ▼, ◀, ▶] or press [AUDIO] to change the setting.

DVD Karaoke [◀, ▶]

- Solo
 - [---]: Vocal OFF
 - [ON]: Vocal ON
- Duet
 - [---]: Vocal OFF
 - [1+2]: Vocal 1, 2 ON
 - [V1]: Vocal 1 only ON
 - [V2]: Vocal 2 only ON

• Choose "----" for Karaoke.

• Choose "V1" or "V2" to duet with the player.

Video CD ([▲, ▼] or [AUDIO])

[LR]: Vocals (Vocals seem to come from the right)

[L]: No Vocals

[R]: Vocals (Vocals seem to come from both left and right)

• Choose "L" for Karaoke.

To clear the display

Press [ENTER].

For your reference

- Karaoke discs may show a menu after each track. Some will have a menu that allows you to play all the tracks.

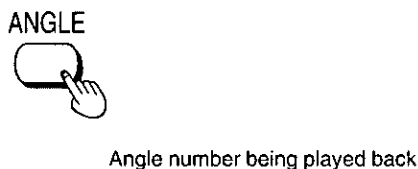
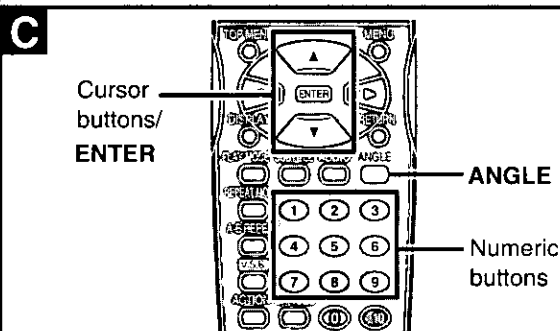
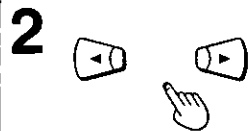
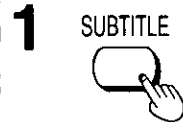
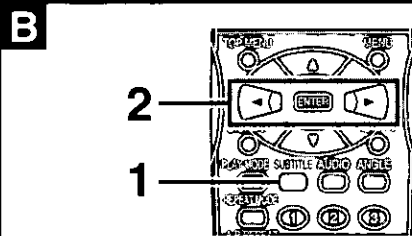
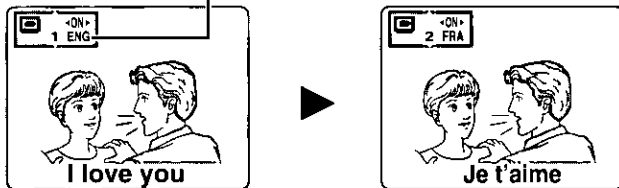
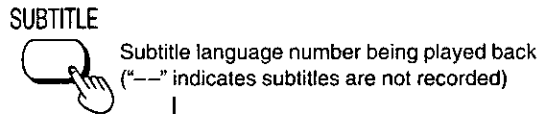
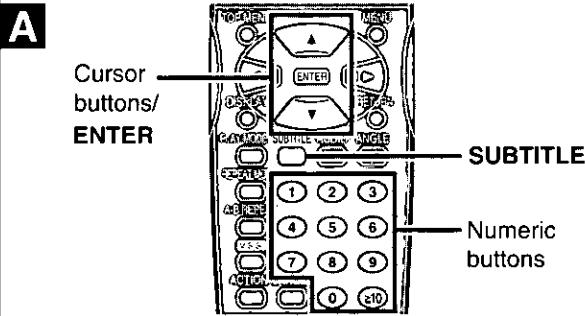

A Changing subtitle language

DVD

Some DVDs have more than one subtitle language recorded on them, and you can change subtitle language during play.

Press [SUBTITLE] during play to display the current language number.

The number changes each time you press the button.

- You can also use the cursor buttons [▲, ▼] or the numeric buttons to change the language number.

To clear the display

Press [ENTER].

B To clear/display the subtitles

1. Press [SUBTITLE].
2. Press the cursor button [◀, ▶] to select "ON" or "OFF".

Note

- In some cases, the subtitle language is not changed to the selected one immediately.
- When a disc supporting closed captions is played, the subtitles and closed captions may overlap each other on the TV monitor. In this case, turn the subtitles off.

For your reference

- You can only select languages if they have been recorded on the disc you are playing.
- If resume (⇨ page 12) is canceled or if you stop play of an interactive DVD, the subtitle languages revert to the initial settings. (⇨ page 25)
- Some discs allow changes to subtitle languages only by using the disc's menus.

C Viewing from another angle

DVD

Some DVDs allow you to view the same scene from different angles. "ANGLE" lights on the FL display to indicate that the feature is available.

Press [ANGLE] during play to display the current angle number.

The number changes each time you press the button.

- You can also use the cursor buttons [▲, ▼] or the numeric buttons to change the angle.

To clear the display

Press [ENTER].

For your reference

- You can only select angles if they have been recorded on the disc you are playing.
- Some discs allow you to set angles before multi-angle scenes are played.
- Some discs allow changes to angles only by using the disc's menus.

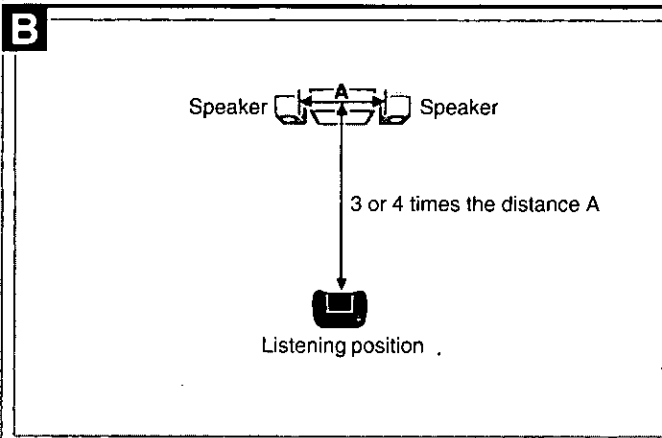
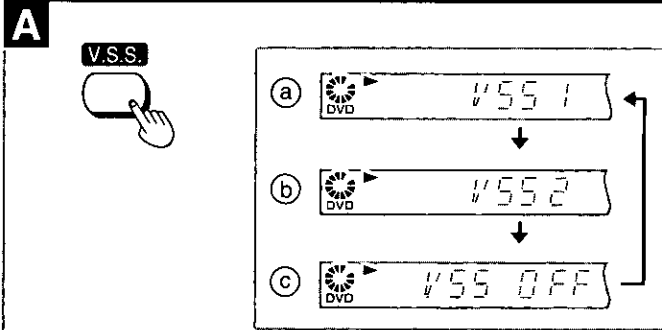
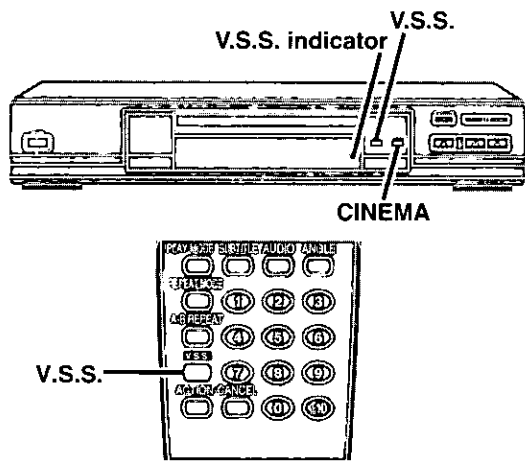

Advanced operations

A Reproducing an Advanced Virtual Surround Sound (V.S.S.) effect

DVD (Dolby Digital, 2 channel or over software only)
 Use this feature to enjoy a surround-like effect if you are using two front speakers.

Press [V.S.S.] during play.

Each time this button is pressed, the player's FL display changes:

- (a) V.S.S. 1 (Natural effect)
- (b) V.S.S. 2 (Emphasized effect)
- (c) V.S.S. is canceled

- The V.S.S. indicator lights up green when the V.S.S. function is activated.

Note

- V.S.S. effect does not work with Karaoke DVDs.
- V.S.S. will not work or will have less effect with some discs.
- Turn off the TV surround sound and other surround sound effects when using this effect.
- Do not use V.S.S. if you have connected surround or center speakers as sound may fail to come from the extra speakers or surround effects may not work correctly.

For your reference B

- For optimum effect, it is recommended that the distance between the television and the listening position be about 3 to 4 times the distance between the right and left front speakers.

•V.S.S. effects

	V.S.S. 1	V.S.S. 2
Stereo discs	The front speakers sound further apart.	The surround-like effect in V.S.S. 1 is increased.
Surround signal recorded discs	Sound seems to come from the side.	

C Changing picture quality for movie viewing DVD-RV30

DVD VCD
Press [CINEMA] on the player.

Improves video quality and enhances detail in dark scenes.

To restore the standard picture mode

Press [CINEMA].

For your reference

- You can also change with the On-Screen Menu Icons. (→ "Ⓢ Digital picture mode", page 23.)

■ Raising dialogue volume

(→ "Ⓢ Dialogue Enhancer", page 23)

DVD-RV30 DVD-RV20

DVD

This mode makes the dialogue in movies easier to hear if the soundtrack has been recorded with surround sound.

- This function is effective with Dolby Digital, three channels or over, where the dialogue is recorded in the center channel.

Repeat play

REPEAT MODE

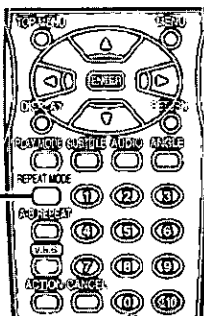

A REPEAT MODE

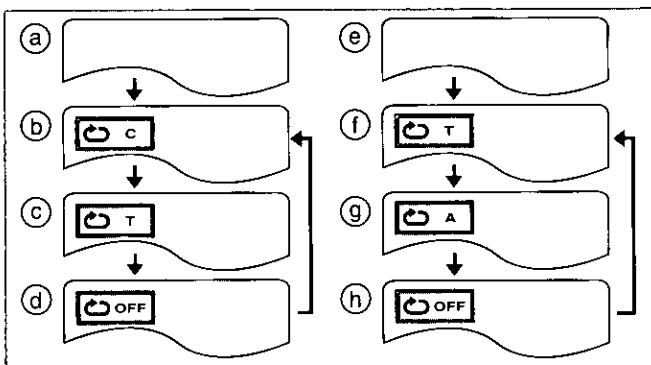

B REPEAT MODE

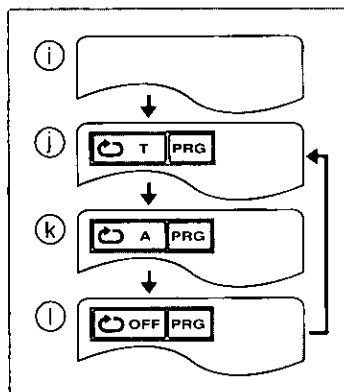

C

1-2

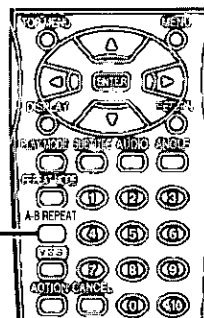

1 A-B REPEAT

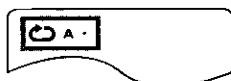

2 A-B REPEAT



A Repeat viewing (listening)

Press [REPEAT MODE] during play.

Each time this button is pressed, the TV monitor changes as illustrated and the disc will repeat a chapter or title (DVD) or a track (Video CD/CD).

Repeat play starts when the display changes.

•DVD

- (a) Normal play
- (b) Repeat of chapter being played
- (c) Repeat of title being played
- (d) Cancel repeat mode (Normal play)

•Video CD/CD

- (e) Normal play
- (f) Repeat of track being played
- (g) Repeat of entire disc contents
- (h) Cancel repeat mode (Normal play)

To return to normal play

Press [REPEAT MODE] until "OFF" is displayed.

Note

- Repeat play may not work correctly with some DVDs.
- Repeat play does not work with an interactive DVD or during menu play of a Video CD with playback control.
- There is no mode for repeating the whole DVD.

B To enjoy program repeat play

If [REPEAT MODE] is pressed during program play (→ page 20), the display changes as illustrated.

- (i) Program play
- (j) Repeat of track being played
- (k) Repeat of all programmed tracks
- (l) Cancel repeat mode (Program play)

To return to program play

Press [REPEAT MODE] until "OFF" is displayed.

C Repeating sections between two specific points (A-B repeat)

- 1 Press [A-B REPEAT] during play at the point where repeat play is to start (A).
- 2 Press [A-B REPEAT] at the point where repeat play is to be concluded (B).

Repeat play of the section between points A and B starts.

To return to normal play

Press [A-B REPEAT] until "••" is displayed.

Note

- A-B repeat play does not work with an interactive DVD.
- Some subtitles recorded around point A or B may fail to appear (DVD).
- A-B repeat play works only within a title (DVD) or a track (Video CD/CD).

For your reference

- The end of a track or title is automatically determined as point B.

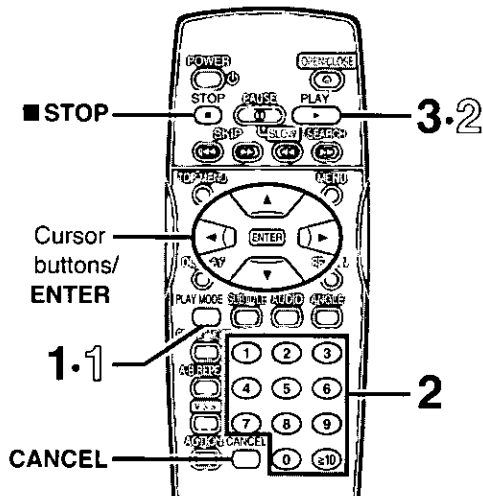

A Program play

VCD CD

The player plays the tracks on the disc in an order you specify.

1 Press [PLAY MODE] while stopped until the illustrated screen appears.

2 Press the numeric buttons to select the track. (→ item ③ on page 7 for number entry.)

The selected track is stored in the memory.

- If you press [ENTER], you can use the cursor buttons [▲, ▼] to select a track. Press [ENTER] to register the track number. (If you select "ALL", all the tracks on the disc will be programmed.)
- Repeat step 2 to select another track.
- Up to 32 tracks can be programmed.

3 Press [▶ PLAY].

Play now begins in the programmed sequence.

To exit the screen

Press [PLAY MODE] twice.

To add tracks

Press [■ STOP] twice during program play to show the program play screen, then repeat step 2.

To return to normal play

1. Press [■ STOP] twice during program play. (Program play is suspended.)
2. Press [PLAY MODE] twice.
3. Press [▶ PLAY].

- The program is retained in the memory.

For your reference

- You can program tracks without the television by observing the unit's display. Use the numeric buttons to enter track numbers.

Clearing the program

When the program play screen is displayed

• To clear the programmed tracks one by one

Select the track, move to "Clear" with the cursor buttons and press [ENTER]. (Selecting the track and pressing [CANCEL] also clears the programmed track.)

• To clear the whole program

Move to "Clear all" with the cursor buttons and press [ENTER]. (The program is also cleared when the player is switched to the standby mode or turned off, or the disc tray is opened.)

B Random play

VCD CD

The player plays the tracks on the disc in random order.

1 Press [PLAY MODE] while stopped until the illustrated screen appears.

2 Press [▶ PLAY].

Play now begins in random order.

To exit the screen

Press [PLAY MODE] once.

To return to normal play

1. Press [■ STOP] twice during random play. (Random play is suspended.)
2. Press [PLAY MODE] once.
3. Press [▶ PLAY].

A

1

PLAY MODE

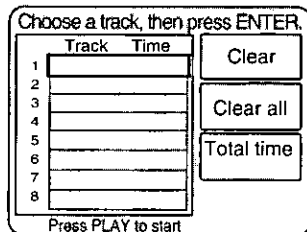

In the case of a CD

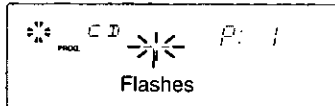

2

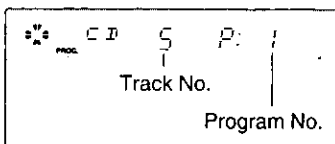
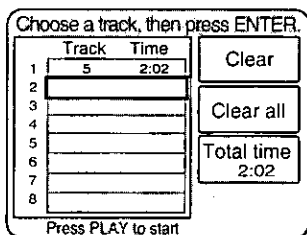
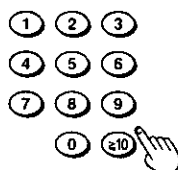

3

PLAY



B

1

PLAY MODE

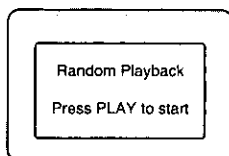

2

PLAY



Using On-Screen Menu Icons

On-Screen Menu Icons

On-Screen Menu Icons are long thin menus that contain information about the disc or player. These menus allow you to perform operations by changing this information.

Examples of On-Screen Menu Icons **A**

The screens depend on the disc contents.

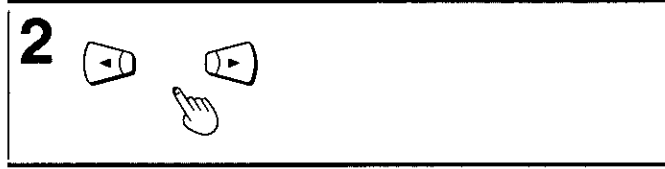
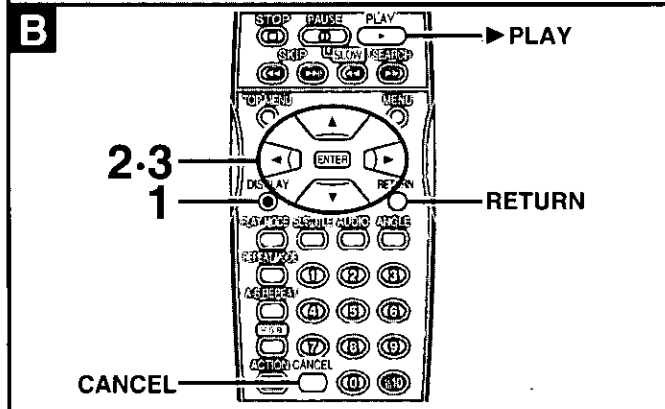
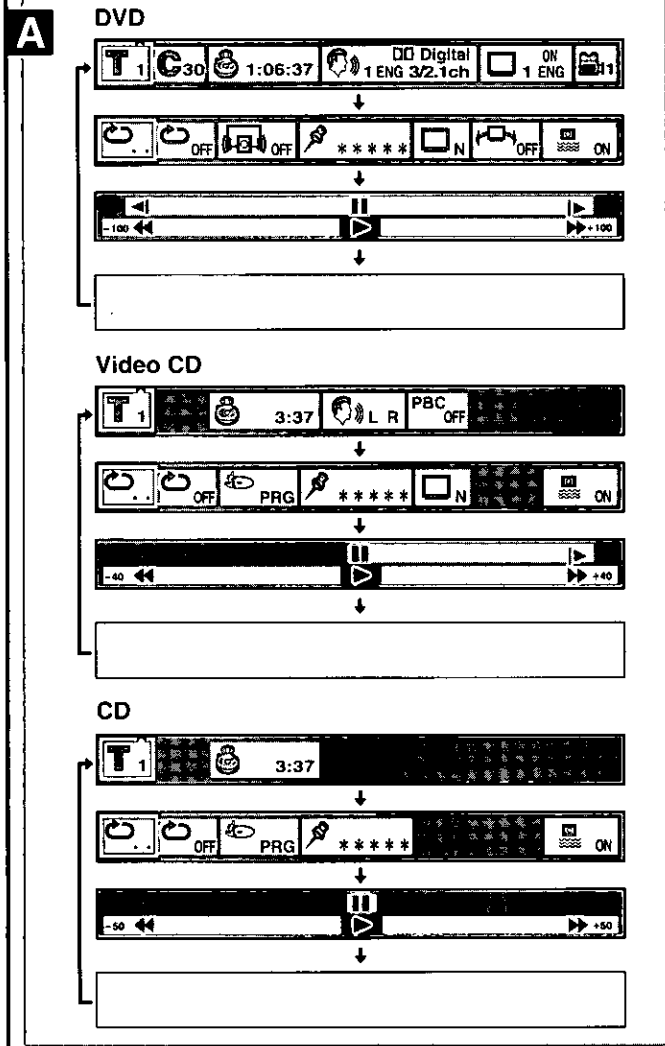

B Common procedures

1 Press [● DISPLAY] during play or in the stop mode.

Each time this button is pressed, the TV monitor changes as shown below.

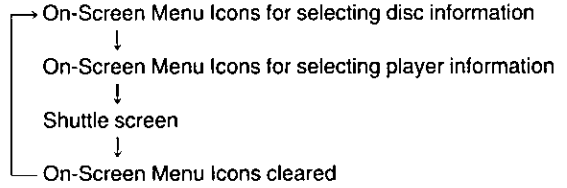

•Some functions cannot be accessed from the stop mode.

2 Press the cursor buttons [◀, ▶] to select the item.

The item is highlighted in yellow.

3 Press the cursor buttons [▲, ▼] to select the setting.

•For some functions, the setting will be registered immediately; for others, [ENTER] or [▶ PLAY] must be pressed.

•When numbers are displayed (e.g. title No.), the numeric buttons are also effective for setting instead of the cursor buttons [▲, ▼]. When numbers are entered with numeric buttons, press [ENTER] to register the setting.

To clear the On-Screen Menu Icons

Press [RETURN] or [CANCEL].

For your reference

- The On-Screen Menu Icons may not be displayed when playing some kinds of DVD software, or if the television's automatic picture zoom function is on. Change the position of the On-Screen Menu Icons in "4 On-Screen Messages" if this occurs. (→ page 27.)
- The color (blue, violet or green) of the On-Screen Menu Icons can be changed. (→ page 27.)
- "▲ ▼" around the icon means that the item can be changed using the cursor buttons [▲, ▼].



Detailed descriptions of each icon

Screen for disc information

■ DVD

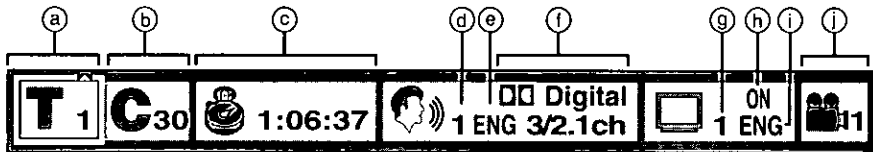

- a **Title No.**
Change the No. with the cursor buttons [▲, ▼] or the numeric buttons and press [ENTER].
- b **Chapter No.**
Change the No. with the cursor buttons [▲, ▼] or the numeric buttons and press [ENTER].
- c **Elapsed playing time**
(hour: minute: second)
Enter the time from which you want to start play and press [ENTER].
Example: To specify "1 hour 6 min. 37 sec.", enter "10637".
- d **Soundtrack language No.**
Change the No. with the cursor buttons [▲, ▼] or the numeric buttons.
- e **Soundtrack language**

ENG: English	SVE: Swedish	CHI: Chinese
FRA: French	NOR: Norwegian	KOR: Korean
DEU: German	DAN: Danish	MAL: Malay
ITA: Italian	POR: Portuguese	VIE: Vietnamese
ESP: Spanish	RUS: Russian	THA: Thai
NLD: Dutch	JPN: Japanese	*: Others

- f **Audio attribute**
Shows the audio attributes of the selected soundtrack (cannot be changed).
LPCM: Linear PCM
(96k or 48k) (16b, 20b or 24b)
("k" stands for kHz and "b" stands for bit.)
Digital: Dolby Digital (1-3/2.1ch)^{※1}
DTS: DTS Digital Surround (1-3/2.1ch)^{※1}
Vocal: --- (OFF) or ON
[DVD Karaoke (Solo)]
Vocal: --- (OFF), V1+V2, V1 or V2
[DVD Karaoke (Duet)]
- g **Subtitle language No.**
Change the No. with the cursor buttons [▲, ▼] or the numeric buttons.
- h **Subtitle on/off**
Select "ON" or "OFF" with the cursor buttons [▲, ▼].
OFF: Subtitle is cleared.
ON: Subtitle is displayed.
- i **Subtitle language**
See the table under item g.
- j **Angle No.**
Change the No. with the cursor buttons [▲, ▼] or the numeric buttons.

■ Video CD/CD

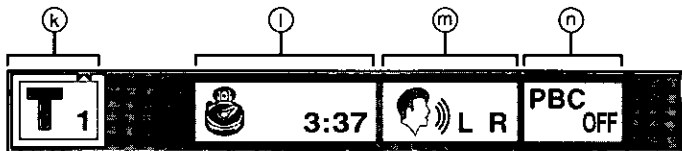

- k **Track No.**
Change the No. with the cursor buttons [▲, ▼] or the numeric buttons and press [ENTER].
- l **Elapsed playing time**
(minute: second)
Display is changed each time the cursor buttons [▲, ▼] are pressed (cannot be changed).
Elapsed playing time ← → Remaining time of the track
↑ → Remaining time of the disc ← → ↓

- m **Audio mode VCD**
Change the mode with the cursor buttons [▲, ▼].
LR: Left channel sound is output from the speaker (L), and right channel sound is output from the speaker (R).
L: Left channel sound only is output from the speakers (L/R).
R: Right channel sound only is output from the speakers (L/R).
- n **Playback control VCD**
Shows whether menu play is on or off (cannot be changed here).
OFF: Menu play is OFF.
ON: Menu play is ON.

Note

•The information actually displayed depends on the disc.

※1 The number of channels recorded on the disc.

Example:
3/2 .1ch

.1:	Subwoofer signal (not displayed if there is no subwoofer signal)
0:	No surround
1:	Mono surround
2:	Stereo surround (left/right)
1:	Center
2:	Front left+Front right
3:	Front left+Front right+Center

Screen for player information

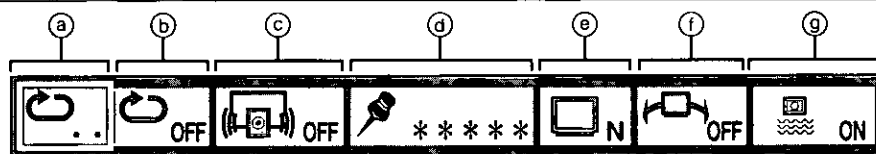

a A-B repeat play

Press [ENTER] during play to store location A and press [ENTER] again to store location B. Repeat play between the two locations starts. Press [ENTER] again to return to normal play.

b Repeat play

Select the mode during play with the cursor buttons [▲, ▼].

DVD

OFF: Normal play

C: Chapter repeat play

T: Title repeat play

VCD CD

OFF: Normal play

T: Track repeat play

A: Disc repeat play

c Dialogue Enhancer **DVD-RV30 DVD-RV20**

DVD

Select the mode during play with the cursor buttons [▲, ▼].

OFF: Normal volume

ON: Louder volume for dialogue

Play mode

VCD CD (→ page 20.)

The current play mode is shown (cannot be changed here).

PRG: Program play

RND: Random play

---: Normal play

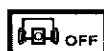

d Marker (Marking parts you want to watch or listen to again)

Press [ENTER] during play and press [ENTER] again at the preferred point to store a marker. (Marker no. replaces "*".) (Up to 5 markers can be stored in the memory.)

To store the next marker, press the cursor button [▶].

•To recall a marker

Select the marker no. with the cursor buttons [◀, ▶] and press [ENTER].

•To clear a marker

Select the marker no. with the cursor buttons [◀, ▶] and press [CANCEL].

•Some subtitles recorded around the marker may fail to appear.

•All the markers are cleared when the player is switched to the standby mode or turned off, or the disc tray is opened.

e Digital picture mode **DVD-RV30**

DVD VCD

Select the mode during play with the cursor buttons [▲, ▼].

N: Normal mode

C: Cinema mode (Cinema position) (Picture for viewing movies)

f Virtual Surround Sound (V.S.S.)

DVD (Dolby Digital, 2ch or over software only) (→ page 18.)

Select the level during play with the cursor buttons [▲, ▼].

OFF: V.S.S. off

1: V.S.S. natural effect

2: V.S.S. emphasized effect

g Turning subwoofer output on and off **DVD-RV30** (→ page 31.)

Select "ON" or "OFF" with the cursor buttons [▲, ▼].

ON: if you have connected a subwoofer

OFF: if you have not connected a subwoofer

Note

- A-B repeat play does not work with an interactive DVD.
- Repeat play and marker functions do not work with an interactive DVD or during menu play of a Video CD with playback control.
- Dialogue Enhancer is effective with Dolby Digital, three channels or over, where the dialogue is recorded in the center channel.

Shuttle screen

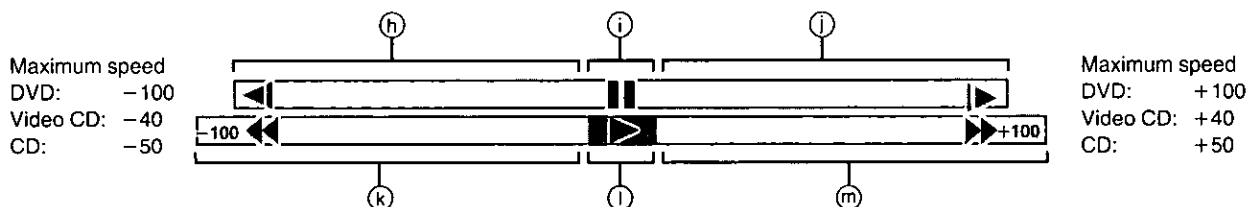

h Slow-motion play (Backward) **DVD**

Press the cursor buttons [▲]→[◀].

i Still/Pause

Press the cursor button [▲].

l Slow-motion play (Forward) **DVD VCD**

Press the cursor buttons [▲]→[▶].

k Rapid reverse

Press the cursor buttons [▼]→[◀].

l Play

Press the cursor button [▼].

m Rapid advance

Press the cursor buttons [▼]→[▶].

For your reference

- Each time the cursor buttons [◀, ▶] are pressed, the speed of rapid reverse/advance and slow-motion play increases up to 5 steps.

Changing initial settings

Change the initial settings to suit your preference and to suit the player to the conditions in which it is being used.

Common procedures

- 1 Press [ACTION] in the stop mode.**
The initial settings screen is displayed.
- 2 Press the cursor buttons [▲, ▼] to select the item and press [ENTER].**
Each screen for setting the value is displayed.
 - 1 Disc Languages (⇒ page 25)**
Change the soundtrack language, subtitle language and the language used in disc's menu which will always be used for every disc to be played back.
 - 2 Ratings (⇒ page 26)**
Change the ratings level to prevent play of discs, skip violent scenes, or replace scenes with others by entering a password. This is also called a parental lock.
 - 3 Menu Language (⇒ page 27)**
Change the language used for the on-screen displays and initial settings menus.
 - 4 On-Screen Messages (⇒ page 27)**
Choose whether "Play", "Still" and other displays will be displayed or not, and the color and position of these displays as well as On-Screen Menu Icons.
 - 5 FL Display (⇒ page 27)**
Change the brightness for the FL display.
 - 6 TV Aspect (⇒ page 10)**
Change the settings to suit the type of television you have connected.
 - 7 Digital Audio Output (⇒ page 34)**
Change the settings to suit the type of digital equipment you have connected.
 - 9 Other Settings (⇒ page 28)**
Choose the kind of picture shown when play is paused, and various other settings to enhance your viewing experience.
- 3 Press the cursor buttons [▲, ▼] to select the setting and press [ENTER].**
•Some items require additional steps. (See the respective page.)
Setting is finished and the initial settings screen is displayed.

To cancel during setup operation

Press [RETURN]. (The previous screen is displayed.)

To clear the initial settings screen

Press [ACTION] or [RETURN].

Note

- There is no No.8 in the initial settings menu of this player.

For your reference

- The numeric buttons can also be used instead of the cursor buttons [▲, ▼] for selecting items or settings. Pressing [ENTER] is not necessary.

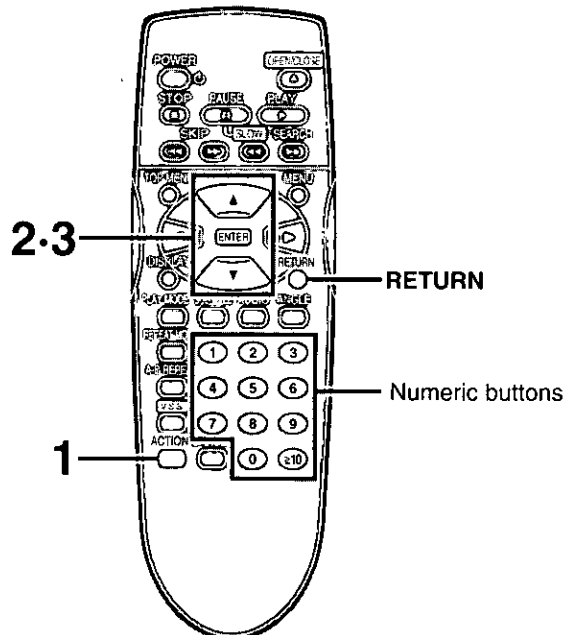

1 ACTION

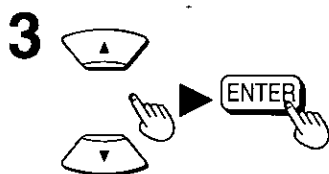
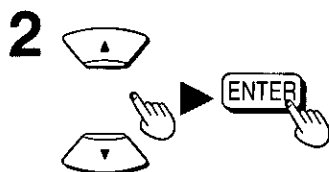
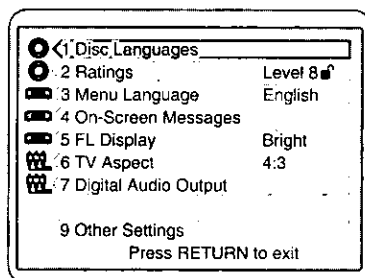

1 Disc Languages

DVD

See page 24 for operation.

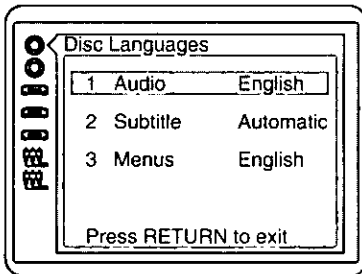

1 Audio	1 English (Factory preset) 2 French 3 Spanish 4 Original The original language of each disc will be selected. 5 Other ***** Another language can be selected.*
2 Subtitle	1 Automatic (Factory preset) Subtitle language will automatically be selected in accordance with the soundtrack language. ● If the language selected for the "1 Audio" is actually used during playback, the subtitles will not appear. ● If another language is used during playback, the subtitles will appear in the language selected at the setup "1 Audio". 2 English 3 French 4 Spanish 5 Other ***** Another language can be selected.*
3 Menus	1 English (Factory preset) 2 French 3 Spanish 4 Other ***** Another language can be selected.*

※ Enter the language code if you select "Other". (See the language code list below.) Press [CANCEL] if you enter the wrong number.

Note

● If the language selected is not available on the disc, the language designated by each disc will be selected.
 There are cases where the language is recorded but the disc designates another language.

Language code list

6565: Afar	6890: Bhutani	7285: Hungarian	7679: Laotian	8084: Portuguese	8471: Tajik
6566: Abkhazian	6976: Greek	7289: Armenian	7684: Lithuanian	8185: Quechua	8472: Thai
6570: Afrikaans	6978: English	7365: Interlingua	7686: Latvian, Lettish	8277: Rhaeto-Romance	8473: Tigrinya
6577: Ameharic	6979: Esperanto	7378: Indonesian	7771: Malagasy	8279: Romanian	8475: Turkmen
6582: Arabic	6983: Spanish	7383: Icelandic	7773: Maori	8285: Russian	8476: Tagalog
6583: Assamese	6984: Estonian	7384: Italian	7775: Macedonian	8365: Sanskrit	8479: Tonga
6588: Aymara	6985: Basque	7387: Hebrew	7776: Malayalam	8368: Sindhi	8482: Turkish
6590: Azerbaijani	7065: Persian	7465: Japanese	7778: Mongolian	8372: Serbo-Croatian	8484: Tatar
6665: Bashkir	7073: Finnish	7473: Yiddish	7779: Moldavian	8373: Singhalese	8487: Twi
6669: Byelorussian	7074: Fiji	7487: Javanese	7782: Marathi	8375: Slovak	8575: Ukrainian
6671: Bulgarian	7079: Faroese	7565: Georgian	7783: Malay	8376: Slovenian	8582: Urdu
6672: Bihari	7082: French	7575: Kazakh	7784: Maltese	8377: Samoan	8590: Uzbek
6678: Bengali, Bangla	7089: Frisian	7576: Greenlandic	7789: Burmese	8378: Shona	8673: Vietnamese
6679: Tibetan	7165: Irish	7577: Cambodian	7865: Nauru	8379: Somali	8679: Volapük
6682: Breton	7168: Scots Gaelic	7578: Kannada	7869: Nepali	8381: Albanian	8779: Wolof
6765: Catalan	7176: Galician	7579: Korean	7876: Dutch	8382: Serbian	8872: Xhosa
6779: Corsican	7178: Guarani	7583: Kashmiri	7879: Norwegian	8385: Sundanese	8979: Yoruba
6783: Czech	7185: Gujarati	7585: Kurdish	7982: Oriya	8386: Swedish	9072: Chinese
6789: Welsh	7265: Hausa	7589: Kirghiz	8065: Punjabi	8387: Swahili	9085: Zulu
6865: Danish	7273: Hindi	7665: Latin	8076: Polish	8465: Tamil	
6869: German	7282: Croatian	7678: Lingala	8083: Pashto, Pushto	8469: Telugu	

2 Ratings

DVD

See page 24 for operation.

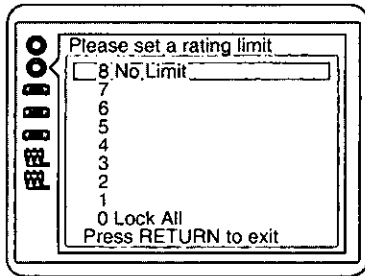

Level 8 (Factory preset)
All DVDs can be played.

Level 7 to 1
Prevents play of DVDs with ratings recorded on them (those that contain adult or violent scenes).

Level 0
Playback of all DVDs is prohibited (e.g. to prohibit playback of DVDs for adults which are not encoded with rating information).

Note

- The rating method differs from disc to disc. There are discs designed for adults that do not have these ratings recorded on them. These discs can be played as normal. To prevent play of these discs, set the rating limit to "0 Lock All".

Setting ratings (When the level is "8")

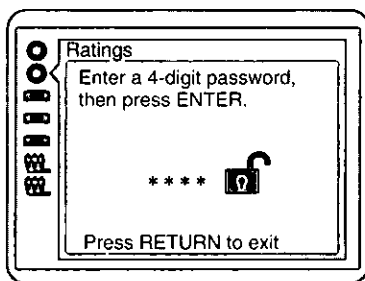

1 Select the level with the cursor buttons [**▲**, **▼**] and press [**ENTER**].

2 Enter a 4-digit password with the numeric buttons and press [**ENTER**].

- Press [**CANCEL**] if you enter the wrong number. The lock symbol appears closed to show the rating is locked. Do not forget your password.

3 Press [**ENTER**].

Setting is finished and the initial settings screen is displayed.

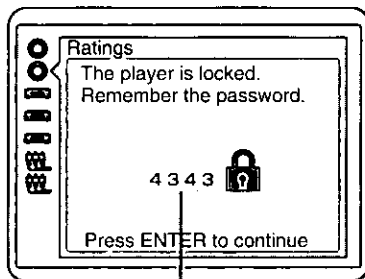

Example: "4343"

Now when you insert a DVD that exceeds the ratings limits you set, a message appears on the television. If you want to play the disc, select "Yes" and enter your password. The unit will unlock temporarily, locking again when the disc tray is opened or the unit is turned off.

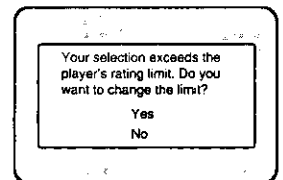

Changing ratings (When the level is "0" to "7")

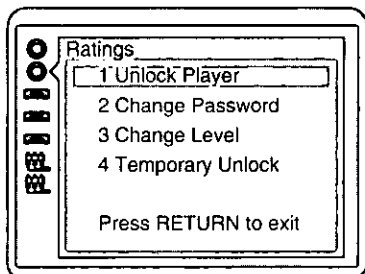

Changes to the settings also requires a password.

1 Select "2 Ratings" in the initial settings screen.

2 Enter your 4-digit password with the numeric buttons and press [**ENTER**].

3 Press the cursor buttons [**▲**, **▼**] to select the item.

To unlock the player (The rating level returns to 8)
Select "1" and then press [**ENTER**].

To change the password

Select "2" and press [**ENTER**]. Enter a new 4-digit password and press [**ENTER**], then press [**ENTER**] again.

To change the rating level

Select "3" and press [**ENTER**]. Select a new level with the cursor buttons [**▲**, **▼**], then press [**ENTER**].

To unlock the player temporarily

Select "4" and then press [**ENTER**].

- The rating is unlocked temporarily only for the current disc. The player is locked again when the disc tray is opened or the player is switched to the standby mode or turned off.

3 Menu Language

See page 24 for operation.

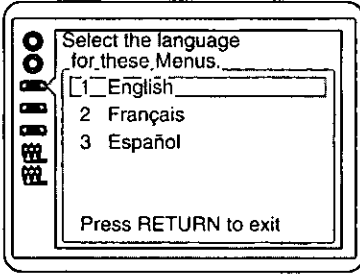

- 1 English (Factory preset)
- 2 Français
- 3 Español

Example: If you selected "2 Français"

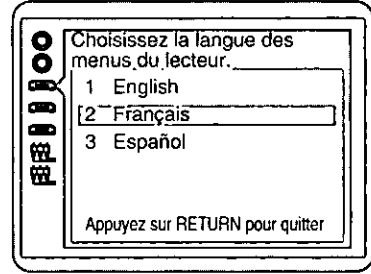

4 On-Screen Messages

See page 24 for operation.

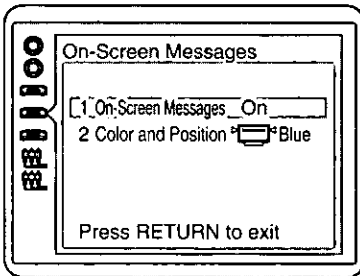

1 On-Screen Messages	1 On (Factory preset) 2 Off
2 Color and Position	<ul style="list-style-type: none"> 1 Blue (Factory preset) 2 Violet 3 Green 4 Blue 5 Violet 6 Green <p>Shown slightly lower. Select if the top of the screen is cut off.</p>

5 FL Display

See page 24 for operation.

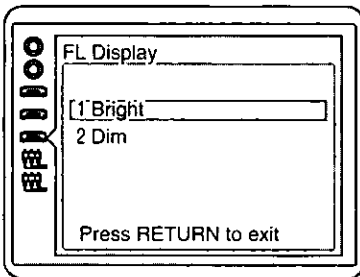

- 1 Bright (Factory preset)
- 2 Dim

9 Other Settings

See page 24 for operation.

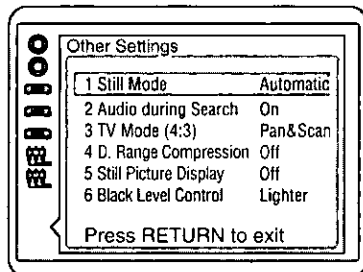

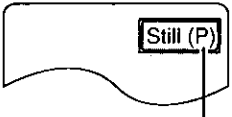
<p>1 Still Mode Select either "Field still" or "Frame still" in the still picture mode.</p>	<p>1 Automatic (Factory preset) 2 Field Select this setting when jittering occurs in the still picture mode when "1 Automatic" is selected. 3 Frame Select if small text or fine patterns cannot be seen clearly in the still picture mode when "1 Automatic" is selected.</p>
<p>2 Audio during Search To select whether audio is heard or not during search (forward direction) at the initial search speed.</p>	<p>1 On (Factory preset) 2 Off</p>
<p>3 TV Mode (4:3) To select whether wide-screen material is played in the pan and scan style or in the letterbox style on a conventional TV (4:3).</p>	<p>1 Pan & Scan (Factory preset) Wide-screen video material will be played in the pan and scan style (the picture is shown with either one or both sides cut off) on a conventional television (4:3). • Video material not formatted in the pan and scan style will be played back in the letterbox style. 2 Letterbox Wide-screen video material will be played in the letterbox style (black bands appear at the top and bottom of the screen) on a conventional television (4:3).</p>
<p>4 D.(Dynamic) Range Compression To compress the dynamic range (the difference between the loudest sound and the softest sound), making it easier to hear dialogue even at low volume. This function only works with Dolby Digital DVD.</p>	<p>1 Off (Factory preset) The dynamic range remains as it was recorded on the disc. 2 On Dynamic range is compressed by increasing soft sounds and reducing loud sounds. Select when viewing discs at low volume, such as late at night.</p>
<p>5 Still Picture Display To display the picture type (DVD), I, P or B in the still picture mode.</p>	<p>1 Off (Factory preset) 2 On</p> <div style="text-align: right;">  <p>Example: P-Picture</p> </div>
<p>6 Black Level Control To select the black level of the picture, "Lighter" or "Darker".</p>	<p>1 Lighter (Factory preset) Select when the player is connected to a TV through the VIDEO OUT terminal or S VIDEO OUT terminal. 2 Darker Select when the player is connected to a TV through the COMPONENT VIDEO OUT (Y/Pa/Pa) terminals.</p>

Note

- Audio is heard at any speed when playing CDs, regardless of any settings at "2 Audio during Search".
- Audio is not heard at any speed when playing DTS Digital Surround CDs, regardless of any settings at "2 Audio during Search".





















For your reference

- **I/P/B**
To efficiently store video on DVD, common elements among frames are used in common, and different elements are recorded with each individual frame. The frame that contains the common elements is called an I-picture, a complete frame in itself. A P-picture is calculated from past I or P-pictures. The frame that fills in the spaces between the I-and P-pictures is called the B-picture. I-pictures have the best picture quality, so they should be used when making picture adjustments.
- **Frame**
Individual images in a video or on the television are called frames.
- **Field**
Half of the video information (video signal) in a frame is called a field. With conventional TV systems, a single frame (a single screen) consists of two fields.
- **Frame still**
The two fields are displayed alternately on the TV screen, so the image may be blurry. However, the image quality is better than field images.
- **Field still**
Only one field (half of the video information) is displayed on the TV screen, so the apparent resolution is low. However, there is no blurring on the screen.

How different kinds of software appear on your television

DVD software is recorded in a variety of picture formats, and how they appear on your TV depends on the software, the kind of TV you have, and the picture mode your TV is set to.

- Letterbox refers to pictures where black bands appear at the top and bottom.
- Pan and scan refers to pictures where part of the picture is cut off so it fills the whole screen.

Television and picture mode Software format	4:3	16:9 full mode	16:9 zoom mode	16:9 auto mode
Wide-screen, pan and scan 	Edges cut off. 	Full screen 	Top and bottom cut off 	Full screen 
Wide-screen, non-pan and scan 	Letterbox 			
Regular (4:3) 	Full screen 	Screen stretched horizontally 	Top and bottom cut off 	Full screen with black bands at right and left 
Regular (4:3) letterbox 	Letterbox 	Letterbox with screen stretched horizontally 	Full screen 	Letterbox with extremities of picture stretched. 

The names given to the television picture modes depends on the make of your television. There may also be slight differences in how the pictures appear on the screen. Refer to your television's operating instructions for details.

■ Updating your audio equipment

Setup chart				
Equipment and settings Types of connection	Equipment	Speakers	Settings in "7 Digital Audio Output"	Page
To add bass to the sound from your television	_____	Subwoofer※1	PCM Down Conversion⇒ "No"	A 31
To enjoy stereo and added bass	Analogue amplifier or system component with 2-channel audio input terminals	●Front speaker (L/R) ●Subwoofer※1	PCM Down Conversion⇒ "No"	B 31
To enjoy stereo and Dolby Pro Logic		●Front speaker (L/R) ●Surround speaker (L/R), Center speaker※2	PCM Down Conversion⇒ "No"	B 31
To enjoy the 5.1 channel surround sound found on DVDs	Amplifier with built-in decoder or a separate decoder-amplifier combination	●Front speaker (L/R) ●Subwoofer※3 ●Surround speaker (L/R)※3 ●Center speaker※3	●PCM Down Conversion⇒ "Yes" ●Dolby Digital/DTS Digital Surround⇒settings depend on your decoding equipment	C 32
To enjoy stereo through a digital amplifier	Audio equipment with digital audio input terminals	Front speaker (L/R)	●PCM Down Conversion⇒ "Yes" ●Dolby Digital⇒"PCM" ●DTS Digital Surround⇒"Off"	D 33

※1 DVD-RV30 only.

※2 If you have connected a Dolby Pro Logic amplifier, you may need to connect center and surround speakers.

※3 Connect speakers if necessary and make the speaker settings on the amplifier.

■ Updating your television

- You can connect CRT projectors, LCD projectors, and projection televisions.
- See "Connection to a television" (⇒ pages 8 and 9) for details on connection.

Note

- The equipment connections described are examples. The illustrations on pages 31 to 33 use DVD-RV30 as an example.
- Peripheral equipment and optional cables sold separately unless otherwise indicated.

A Connecting a subwoofer DVD-RV30

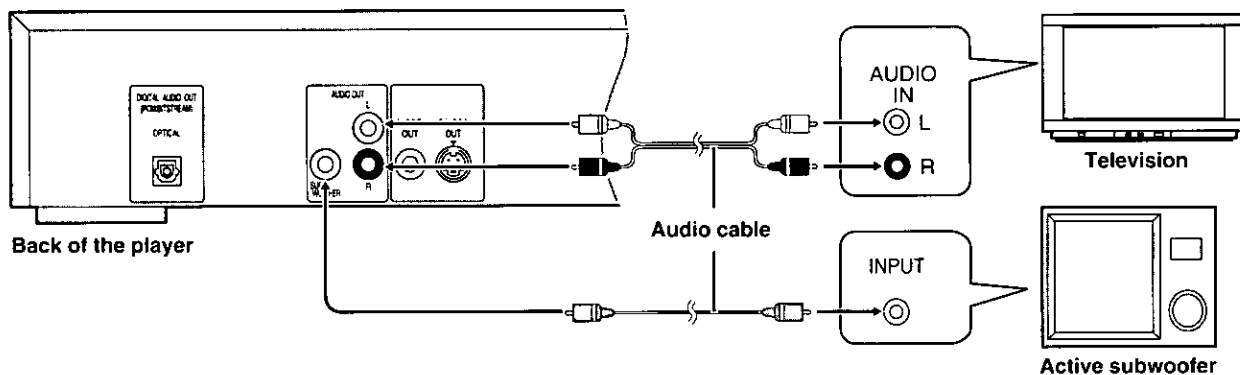

- Use the On-Screen Menu Icons to turn subwoofer output on (⇒ item ④ on page 23).
- Place the subwoofer as close as possible to the front center.
- Adjust the volume of the subwoofer to suit your preference.

When you have finished connection

- Go to "7 Digital Audio Output" and set "1 PCM Down Conversion" to "No" (⇒ page 34).

B Connecting audio equipment with 2-channel audio input terminals

You can enjoy stereo sound if you connect an amplifier or system component that has 2-channel audio input terminals. By connecting a subwoofer, you can also enjoy powerful bass.

■ Connecting the amplifier or system component

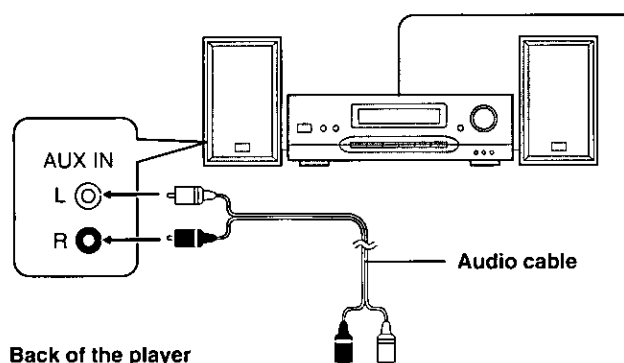

Amplifier and speakers or system component

- Read the instructions for the amplifier and speakers or system component for connection details.

Dolby Pro Logic amplifiers

- If you connect an amplifier with Dolby Pro Logic, you will also need to connect center and surround speakers to enjoy surround sound. Read the instructions for the equipment for connection details.
- Turn off V.S.S. (⇒ page 18) and subwoofer output (⇒ item ④ on page 23). Dolby Pro Logic will not function correctly if they are on.

Back of the player

■ Connecting a subwoofer DVD-RV30

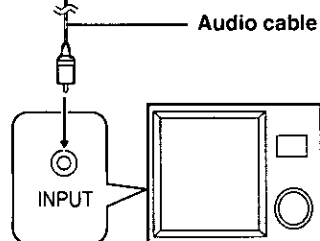

Active subwoofer

- Use the On-Screen Menu Icons to turn subwoofer output on (⇒ item ④ on page 23).
- Place the subwoofer as close as possible to the front center.
- Adjust the volume of the subwoofer to suit your preference.

When you have finished connection

- Go to "7 Digital Audio Output" and set "1 PCM Down Conversion" to "No" (⇒ page 34).

C Connecting an amplifier with a built-in decoder

You can enjoy the powerful audio found on DVD recorded with Dolby Digital or DTS Digital Surround by connecting an amplifier with a built-in decoder or a separate decoder-amplifier combination.

Back of the player

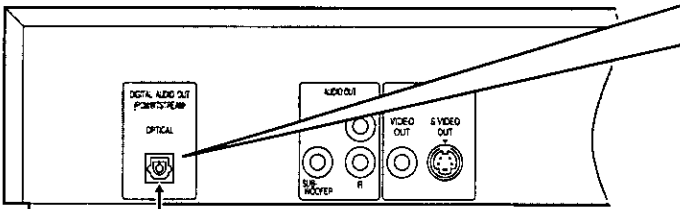

Note when connecting the optical digital audio cable

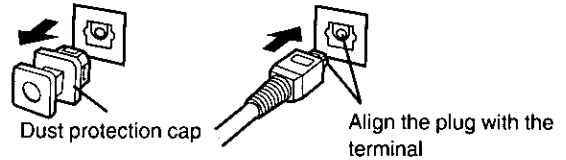

- Remove the dust protection cap from the optical digital audio output terminal and connect the cable firmly so that the configurations of both the cable and the terminal match.
- Keep the dust protection cap and reattach when not using the terminal.

Optical digital audio cable

- Do not bend the optical digital audio cable when connecting it.

Amplifier with a built-in decoder

- Read the instructions for the amplifier and speakers for connection details.

Speaker

- Front speaker (L/R)
- Center speaker
- Surround speaker (L/R)
- Subwoofer
- You can connect from 3 to 5 speakers including the front two.

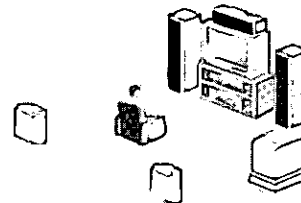
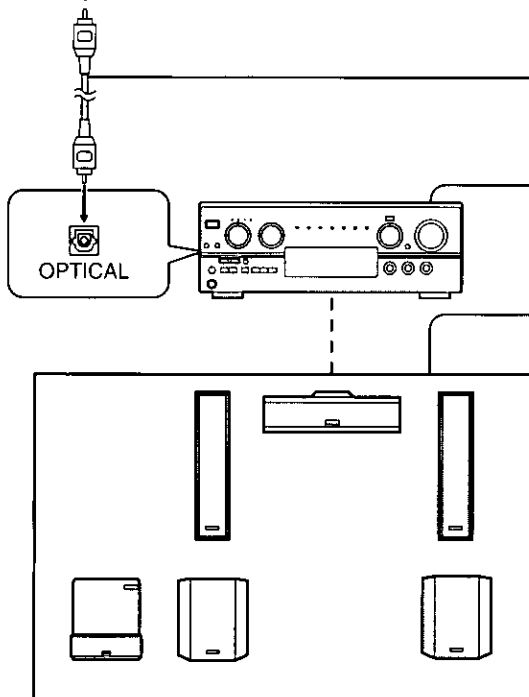

When you have finished connection

Make changes to "7 Digital Audio Output" to suit your decoder (⇒ page 34).

Item	Decoder		
	Dolby Digital decoder	DTS Digital Surround decoder	Dolby Digital/ DTS Digital Surround decoder
PCM Down Conversion	Yes*	Yes*	Yes*
Dolby Digital	Bitstream	PCM	Bitstream
DTS Digital Surround	Off	Bitstream	Bitstream

*If this is set to "No", no audio will be output when DVDs recorded in 96 kHz linear PCM are played. (Audio will be output if the DVD does not have copyright protection recorded on it.)

• These changes to digital audio output must be made, otherwise bitstream signals the decoder cannot handle will be output. If these signals are output, "noise" will be output which can cause harm to your ears and speakers.

Note

- You cannot use DTS Digital Surround decoders not suited to DVD.

D Connecting audio equipment with digital audio input terminals

Back of the player

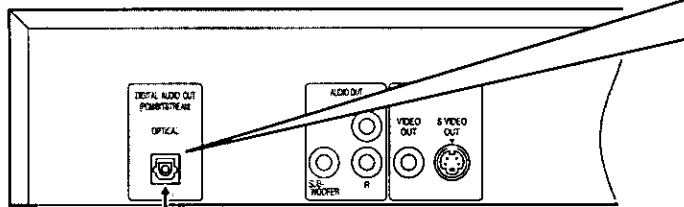

Note when connecting the optical digital audio cable

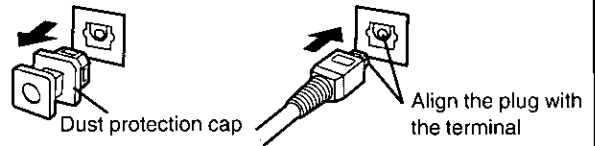

- Remove the dust protection cap from the optical digital audio output terminal and connect the cable firmly so that the configurations of both the cable and the terminal match.
- Keep the dust protection cap and reattach when not using the terminal.

Optical digital audio cable

- Do not bend the optical digital audio cable when connecting it.

System component or amplifier with digital audio input terminals and speakers

- Read the instructions for the amplifier and speakers or system component for connection details.

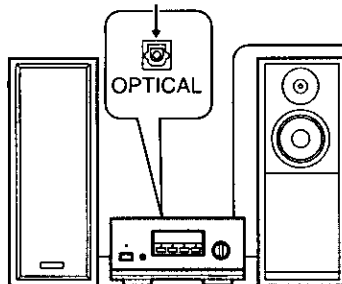

When you have finished connection

Make changes to "7 Digital Audio Output" as shown (☞ page 34).

PCM Down Conversion	Yes*
Dolby Digital	PCM
DTS Digital Surround	Off

※If this is set to "No", no audio will be output when DVDs recorded in 96 kHz linear PCM are played. (Audio will be output if the DVD does not have copyright protection recorded on it.)

- These changes to digital audio output must be made, otherwise signals the equipment cannot handle, bitstream, will be output. If the signals are output as bitstream, "noise" will be output which can cause harm to your ears and speakers.

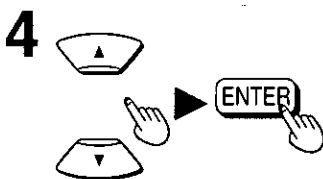
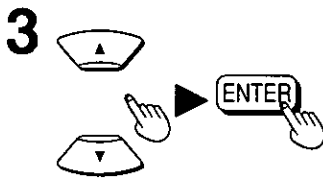
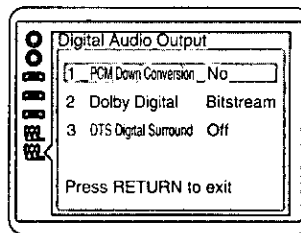
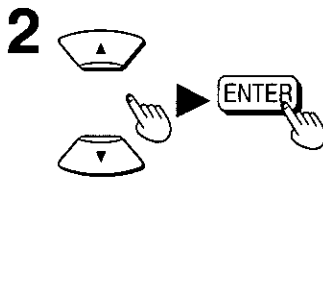
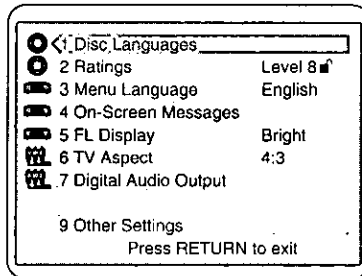
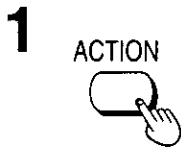
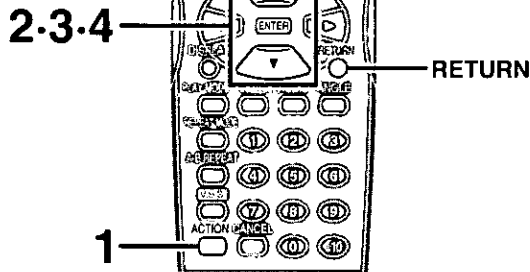

Selecting digital output

Select the digital output to be output from the optical digital audio output terminal of the player.

- 1 Press [ACTION] in the stop mode.**
The initial settings screen is displayed.
- 2 Press the cursor buttons [▲, ▼] to select "7 Digital Audio Output" and press [ENTER].**
- 3 Press the cursor buttons [▲, ▼] to select the item and press [ENTER].**

1 PCM Down Conversion:

Select the output when playing DVD recorded in 96 kHz linear PCM.

2 Dolby Digital:

To select the signal format (Bitstream or PCM) to be output from the optical digital audio output terminal during playback of DVDs recorded in Dolby Digital.

3 DTS Digital Surround:

To select whether DTS Digital Surround bitstream is output from the optical digital audio output terminal or no digital audio is output during playback of DVDs recorded in DTS Digital Surround.

- 4 Press the cursor buttons [▲, ▼] to select the setting and press [ENTER].**

When "1 PCM Down Conversion" is selected

- 1 No:** No digital audio is output during playback of DVDs recorded in 96 kHz linear PCM. (Factory preset)
 - If the DVD is recorded in 48 kHz linear PCM, digital audio converted to 48 kHz/16 bit is output irrespective of the setting.
 - Audio will be output using the original audio recording system if the DVD has not been copyright-protected.
- 2 Yes:** During playback of DVDs recorded in 48 kHz or 96 kHz linear PCM, digital audio converted to 48 kHz/16 bit is output. (Digital output of PCM audio is restricted to 48 kHz/16 bit or below for copyright protection.)

When "2 Dolby Digital" is selected

- 1 Bitstream*2:** Dolby Digital bitstream (1ch–5.1ch) is output during playback of DVDs recorded in Dolby Digital. (Factory preset)
- 2 PCM:** Digital audio converted to 48 kHz/16 bit PCM (2ch) is output during playback of DVDs recorded in Dolby Digital.

When "3 DTS Digital Surround" is selected

- 1 Off:** No digital audio is output during playback of DVDs recorded in DTS Digital Surround. (Factory preset)
- 2 Bitstream*2:** DTS Digital Surround bitstream (1ch–5.1ch) is output during playback of DVDs recorded in DTS Digital Surround.

The screen illustrated in step 2 is displayed.

To cancel during setup operation

Press [RETURN]. (The previous screen is displayed.)

To clear the initial settings screen

Press [ACTION] or [RETURN].

Recommended setting of "Digital Audio Output"

Make settings as shown in table below depending on the kind of equipment that is connected to the optical digital audio output terminal.

Type of equipment connected	Recommended setting		
	1 PCM Down Conversion	2 Dolby Digital	3 DTS Digital Surround
No equipment is connected	<u>No</u>	<u>Bitstream</u>	<u>Off</u>
Digital audio equipment (no decoder) (⇒ page 33)	Yes*1	PCM*2	<u>Off</u> *2
Dolby Digital decoder (⇒ page 32)	Yes*1	<u>Bitstream</u>	<u>Off</u>
DTS Digital Surround decoder (⇒ page 32)	Yes*1	PCM	Bitstream
Dolby Digital/DTS Digital Surround decoder (⇒ page 32)	Yes*1	<u>Bitstream</u>	Bitstream

• Underlined items are factory preset.

*1 If it is set to "Yes", the player converts linear PCM to 48 kHz even during analog output.

Do the following if you wish to take advantage of high quality 96 kHz sound.

Select "1 No" and connect this player's audio output terminal to an amplifier's audio input terminal with the audio/video cable (included) or an audio cable (not included).

*2 When connecting an amplifier (with an optical digital input terminal) which does not contain a Dolby Digital or DTS Digital Surround decoder, be sure to select "PCM" at the "2 Dolby Digital" and "Off" at the "3 DTS Digital Surround". If "Bitstream" is selected, any attempt to play DVDs (or CDs recorded in DTS) may cause such a high level of noise that can injure your ears and damage your speakers.

For your reference

- Dolby Digital is a digital sound compression technique developed by the Dolby Laboratories, Inc. Supporting 5.1-channel surround sound, as well as stereo (2-channel) sound, this technique enables a large quantity of sound data to be efficiently recorded on a disc.
- DTS Digital Surround is a 5.1-channel surround sound system, which is widely used in movie theaters around the world. The separation between channels is good and provides a very real surround effect.
- Linear PCM is an uncompressed digital audio signal. While a CD is recorded in 44.1 kHz/16 bit, a DVD is recorded in 48 kHz/16 bit up to 96 kHz/24 bit. Therefore, the sound reproduced with these signals is potentially better than that found on CDs. This player reproduces linear PCM in two channels.
- Bitstream is a compressed digital audio signal. This signal can be decoded into different channels to produce, for instance, 5.1-channel surround sound.
- The digital audio output terminal (optical) converts electrical signals into optical signals and transfers them to an amplifier. These optical signals are immune from electrical interference, and they also have minimal effect on other equipment.

Manufactured under license from Dolby Laboratories. "Dolby" and the double-D symbol are trademarks of Dolby Laboratories. Confidential Unpublished Works. © 1992–1997 Dolby Laboratories, Inc. All rights reserved.

Troubleshooting

Before requesting service for this player, check the chart below for a possible cause of the problem you are experiencing. Some simple checks or a minor adjustment on your part may eliminate the problem and restore proper operation.

If you are in doubt about some of the check points, or if the remedies indicated in the chart do not solve the problem, refer to the directory of Authorized Service Centers (enclosed with this unit) to locate a convenient service center, or consult your dealer for instructions.

For detailed instructions, contact an authorized servicer in the U.S.A. and Panasonic Canada Inc. Customer Care Centre in Canada.

In the U.S.A. 1-800-211-7262 or web site (<http://www.panasonic.com>)

In Canada 905-624-5505 or web site (www.panasonic.ca)

Reference pages are shown as black circled numbers ❸.

Common Problems

No power.	Insert the AC plug securely into the household AC outlet. ❸
The player is automatically switched to the standby mode.	To conserve power, the player is automatically switched to the standby mode after approx. 30 minutes have elapsed in the stop mode (Auto power-off function). Turn the power back to ON.
Play fails to start even when [▶ PLAY] is pressed. Play starts but then stops immediately.	Condensation has formed: wait about 1 to 2 hours for it to evaporate. This player cannot play discs other than DVD, Video CD and CD. ❸ DVDs with a region number other than "1" or "ALL" cannot be played. DVDs with multiple region numbers including "1" can be played. ❸ The disc may be dirty and may require cleaning. ❸ Ensure that the disc is installed with the label of the side to be played facing upwards. ❶
No picture.	Ensure that the equipment is connected properly. ❸ ❹ Ensure that the input setting for the television is Video.
No sound. Distorted sound.	Ensure that the equipment is connected properly. ❸ ❹ ❺ ❻–❸ Ensure that the input settings for the television and stereo system are correct.
Picture is distorted during rapid advance or rapid reverse.	The picture will be somewhat distorted at times: this is normal.
No key operation (by the player and/or the remote control) is effective.	Some operations may be prohibited by the disc. Press [POWER ⏻/⏹] to switch the player to the standby mode and then back to ON. Alternatively, press [POWER ⏻/⏹] to switch the player to the standby mode, disconnect the AC power supply cord and then reconnect it. (The player may not be operating properly due to lightning, static electricity or some other external factor.)
The picture shown on the television is not normal. (The sides of the picture are cut off or black bands appear at the top and bottom of the screen.)	Go to the initial settings menu "6 TV Aspect" and change the setting to suit your television. You may also need to change the screen mode on the television itself. ❶ ❷
No on-screen display.	The "Off" setting is selected for "1 On-Screen Messages" in "4 On-Screen Messages": select "On". ❷
On-Screen Menu Icons not displayed or only partially displayed on the TV screen.	Change the position of the On-Screen Menu Icons using "2 Color and Position" in "4 On-Screen Messages" of the initial settings. ❷
The language for the player's menus and on-screen messages is wrong.	Go to the initial settings menu "3 Menu Language" and change the language. ❷
No operations can be performed with the remote control.	To conserve power, the player is automatically switched to the standby mode after approx. 30 minutes have elapsed in the stop mode (Auto power-off function). Turn the power back to ON. Check the batteries are installed with the correct polarities (+ and -). ❸ The batteries are depleted: replace them with new ones. ❸ Point the remote control at the remote control sensor and operate. ❸ Operate the remote control at a distance of not more than 23 feet (7 m) from the remote control sensor. ❸ Remove the obstacles between the remote control and remote control sensor. ❸

DVD

No subtitles.	Subtitles appear only with discs which contain them. Subtitles are cleared from the TV monitor. Display the subtitles. 17 22
Alternative soundtrack (or subtitle) languages fail to be selected.	An alternative language is not selected with discs which do not contain more than one language. In the case of some discs, the alternative language cannot be selected by operating the [AUDIO] or [SUBTITLE]. Try selecting it from the disc's menu if one is available. 15
Angle cannot be changed.	This function is dependent on software availability. Even if a disc has a number of angles recorded, these angles may be recorded for specific scenes only (when "ANGLE" lights up on the player's FL display).
Soundtrack and/or subtitle language is not the one selected at the initial settings.	If the soundtrack and/or subtitle language does not exist on the disc, the language selected at the initial settings will not be seen/heard.
The disc's menu is displayed in French (example).	The setup "3 Menus" of "1 Disc Languages" is set to French: select English.
Sound does not come from a speaker.	Check the connections. 3 9 30-33 If you have a subwoofer connected to this player, use the On-Screen Menu Icons with the remote control to turn subwoofer output on. (DVD-RV30 only) 26 If you have connected this player to an amplifier (with built-in decoder) through the digital audio output terminal, go to the initial settings menu "7 Digital Audio Output" and change the settings to "Bitstream" for "2 Dolby Digital" or "3 DTS Digital Surround". 42 No surround sound is output when the virtual surround effect is activated ("V.S.S. 1" or "V.S.S. 2"). Select "V.S.S. OFF". 14
The password for rating level has been forgotten. Reset all the settings to Factory Preset.	While the player is in the stop mode, hold the player's [◀◀/▶▶] and the [■] down simultaneously and then hold the [▲ OPEN/CLOSE] down for longer than 3 seconds (until "Initialized" disappears from the TV monitor). All initial settings will return to the default values.
The vocals cannot be turned off.	You have selected an audio channel that includes a vocal channel. Read the disc's jacket to choose the correct channel. 16
A menu is shown after playing each song on a Karaoke DVD.	Most Karaoke DVDs are designed to do this. Some discs have an item in the menu that allows you to play all the songs.

Video CD

No menu play.	This function works only for Video CDs with playback control. 6
----------------------	---

Self-diagnosis display function

When an error or trouble is detected during operation, a message appears in the FL display.
When a message has appeared, check out the details given below.

Message	Player status	Remedy
CHECK THE DISC	Disc is dirty.	Wipe the disc clean.
H □ □ □ □ stands for a number.	Trouble is likely to have occurred. The number following "H" differs depending on the status of the player.	Press [POWER ⏻/I] to switch the player to the standby mode and then back to ON. Alternatively, press [POWER ⏻/I] to switch the player to the standby mode, disconnect the AC power supply cord, and then reconnect it.

• If the message fails to be cleared even when remedial action is taken, ask a service technician to repair the player.

Disc handling

Choose discs with these marks:



However, do not use irregularly shaped discs, such as heart-shaped. (Discs of the sort can damage the player.)

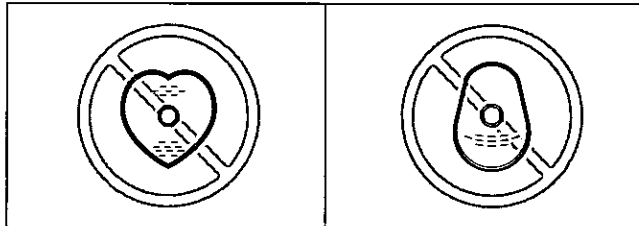

■ How to hold a disc

Do not touch the recorded surface.

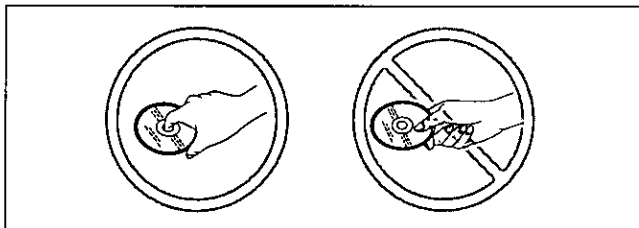

■ If the surface is dirty

Wipe it with a damp cloth and then wipe dry.

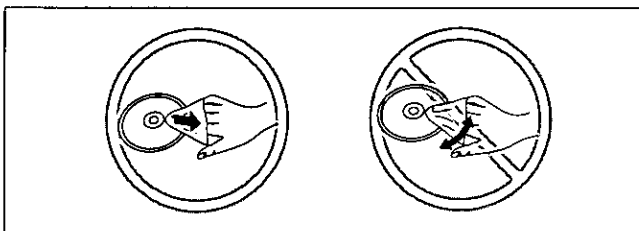

■ If the disc is brought from a cold to a warm environment, moisture may form on the disc

Wipe with a soft, dry, lint-free cloth before using the disc.

■ Handling precautions

- Do not write on the label side with a ball-point pen or other writing instrument.
- Do not use record cleaning sprays, benzine, thinner, static electricity prevention liquids or any other solvent.
- Do not attach labels or stickers to discs. (Do not use discs with exposed adhesive from tape or left over peeled off stickers.)
- Do not use scratch-proof protectors or covers other than those specified for use with this player.

■ Do not place or store discs in the following places

- Locations exposed to direct sunlight
- Humid or dusty locations
- Locations directly exposed to a heat vent or heating appliance

Product Service

Do not attempt to remove the cover(s) or repair the unit yourself. Refer servicing to qualified personnel only.

Product information

For product service, product information or assistance with product operation, refer to the servicenter directory.

If you ship the product

Carefully pack and send it prepaid, adequately insured and preferably in the original carton. Attach a postage-affixed letter, detailing the complaint, to the outside of the carton. **DO NOT send the product to the Executive or Regional Sales offices. They are NOT equipped to make repairs.**

Maintenance

To clean this unit, wipe with a soft, dry cloth.

If the surfaces are extremely dirty, use a soft cloth dipped in a soap-and-water solution or a weak detergent solution.

- Never use alcohol, paint thinner or benzine to clean this unit.
- Before using chemically treated cloth, read the instructions that came with the cloth carefully.

Panasonic

Technics

Quasar

*For Product Information, Operating Assistance, Literature Request, Dealer Locations, and all Customer Service inquiries please contact:
1-800-211-PANA (7262), Monday-Friday 9 am-9 pm; Saturday-Sunday 9 am-7 pm, EST.*

*Web Site: <http://www.panasonic.com>
You can purchase parts, accessories or locate your nearest servicenter by visiting our Web Site.*

Accessory Purchases:

1-800-332-5368 (Customer Orders Only)
Panasonic Services Company 20421 84th Avenue South, Kent, WA 98032
(6 am to 5 pm Monday-Friday; 6 am to 10:30 am Saturday; PST)
(Visa, MasterCard, Discover Card, American Express, Check)

Factory Servicenters Locations

<p>CALIFORNIA 6550 Katella Avenue Cypress, CA 90630</p> <p>800 Dubuque Avenue S. San Francisco CA 94080</p> <p>20201 Sherman Way Suite 102 Canoga Park, CA 91306</p> <p>3878 Ruffin Road Suite A San Diego, CA 92123</p> <p>COLORADO 1640 South Abilene Street Suite D Aurora, CO 80012</p> <p>FLORIDA 3700 North 29th Avenue Suite 102 Hollywood, FL 33020</p>	<p>GEORGIA 8655 Roswell Road Suite 100 Atlanta, GA 30350</p> <p>ILLINOIS 9060 Golf Road Niles, IL 60714</p> <p>1703 North Randall Road Elgin, IL 60123 (Pick-up/Drop-off only)</p> <p>MARYLAND 62 Mountain Road Glen Burnie, MD 21061</p> <p>MASSACHUSETTS 60 Glacier Drive Suite G Westwood, MA 02090</p>	<p>MICHIGAN 37048 Van Dyke Avenue Sterling Heights, MI 48312</p> <p>MINNESOTA 7850-12th Avenue South Airport Business Center Bloomington, MN 55425</p> <p>OHIO 2236 Waycross Road Civic Center Plaza Forest Park, OH 45240</p> <p>PENNSYLVANIA 2221 Cabot Blvd. West Suite B Langhorne, PA 19047</p> <p>Chartiers Valley Shopping Center 1025 Washington Pike Bridgeville, PA 15017</p>	<p>TENNESSEE 3800 Ezell Road Suite 806 Nashville, TN 37211</p> <p>TEXAS 7482 Harwin Drive Houston, TX 77036</p> <p>13615 Welch Road Suite 101 Farmers Branch TX 75244</p> <p>WASHINGTON 20425-84th Avenue South Kent, WA 98032</p> <p>HAWAII 99-859 Iwaiwa Street Aiea, Hawaii 96701 Phone (808) 488-1996 Fax (808) 486-4369</p>
---	--	--	---

Service in Puerto Rico

*Matsushita Electric of Puerto Rico, Inc. Panasonic Sales Company/Factory Servicenter:
Ave. 65 de Infanteria, Km. 9.5, San Gabriel Industrial Park, Carolina, Puerto Rico 00985
Phone (787) 750-4300 Fax (787) 768-2910*

For Your Reference

Specifications

Power requirements:

Units for U.S.A. and Canada: AC 120 V, 60 Hz

Power consumption:

Units for U.S.A. and Canada: 14 W

Dimensions:

DVD-RV30: 16^{15/16}" (W) × 10^{3/4}" (D) × 3^{1/4}" (H)
[430 (W) × 273 (D) × 82 (H) mm]
(excluding protrusions)

DVD-RV20 **DVD-RV10:** 16^{15/16}" (W) × 10^{5/8}" (D) × 3^{1/4}" (H)
[430 (W) × 269 (D) × 82 (H) mm]
(excluding protrusions)

Mass: 6.4 lb. (2.9 kg)

Signal system: NTSC

Operating temperature range:

+41 to +95 °F (+5 to +35 °C)

Operating humidity range: 5 to 90 % RH (no condensation)

Discs played:

(1) DVD-Video disc

- 5" (12 cm) single-sided, single-layer
- 5" (12 cm) single-sided, dual-layer
- 5" (12 cm) double-sided, single-layer
- 3" (8 cm) single-sided, single-layer
- 3" (8 cm) single-sided, dual-layer
- 3" (8 cm) double-sided, single-layer

(2) Compact disc (CD-DA, Video CD)

- 5" (12 cm) disc
- 3" (8 cm) disc

Video output:

Output level: 1 Vp-p (75 Ω)

Output terminal: Pin jack

Number of terminals: 1 system

S video output:

Y output level: 1 Vp-p (75 Ω)

C output level: 0.286 Vp-p (75 Ω)

Output terminal: S terminal

Number of terminals: 1 system

DVD-RV30

Component video output:

Y output level: 1 Vp-p (75 Ω)

P_B output level: 0.7 Vp-p (75 Ω)

P_R output level: 0.7 Vp-p (75 Ω)

Output terminal: Pin jack
(Y: green, P_B: blue, P_R: red)

Audio output:

Output level: 2 Vrms (1 kHz, 0 dB)

Output terminal: Pin jack

Mixed output (L/R): 1 system

DVD-RV30

Subwoofer output: 1 system

Audio signal output characteristics:

(1) Frequency response:

- DVD (linear audio): 4 Hz–22 kHz (48 kHz sampling)
4 Hz–44 kHz (96 kHz sampling)
- CD audio: 4 Hz–20 kHz (EIAJ)

(2) S/N ratio:

- CD audio: 115 dB (EIAJ)

(3) Dynamic range:

- DVD (linear audio): 102 dB
- CD audio: 98 dB (EIAJ)

(4) Total harmonic distortion:

- CD audio: 0.0025 % (EIAJ)

Digital audio output:

Optical digital output: Optical terminal

Pickup:

Wave length: 665 nm

Laser power: CLASS II

Power consumption in standby mode:
Units for U.S.A. and Canada: 2.0 W

Note

Specifications are subject to change without notice.
Mass and dimensions are approximate.

Apparatus Claims of U.S. Patent Nos. 4,631,603, 4,577,216, and 4,819,098, licensed for limited viewing uses only.

This product incorporates copyright protection technology that is protected by method claims of certain U.S. patents and other intellectual property rights owned by Macrovision Corporation and other rights owners. Use of this copyright protection technology must be authorized by Macrovision Corporation, and is intended for home and other limited viewing uses only unless otherwise authorized by Macrovision Corporation. Reverse engineering or disassembly is prohibited.

Panasonic Consumer Electronics Company,
Division of Matsushita
Electric Corporation of America
One Panasonic Way Secaucus,
New Jersey 07094
<http://www.panasonic.com>

Matsushita Electric Industrial Co., Ltd.
Corporate Management Division for North Americas
Sales Office for North America
Tokyo Panasonic Sales Section
World Trade Center Building
4-1, Hamamatsu-cho, 2-chome, Minato-ku,
Tokyo 105-6132, Japan

Panasonic Sales Company,
Division of Matsushita Electric of
Puerto Rico, Inc. ("PSC")
Ave. 65 de Infantería, Km. 9.5
San Gabriel Industrial Park, Carolina,
Puerto Rico 00985

Panasonic Deutschland GmbH
Military Sales Section
Hagenauer Str. 43
65203 Wiesbaden
Germany

Panasonic Canada Inc.
5770 Ambler Drive
Mississauga, Ontario
L4W 2T3
www.panasonic.ca



© 1999 Matsushita Electric Industrial Co., Ltd.

Printed in Japan

VQT8429
F1299ST0

Free Manuals Download Website

<http://myh66.com>

<http://usermanuals.us>

<http://www.somanuals.com>

<http://www.4manuals.cc>

<http://www.manual-lib.com>

<http://www.404manual.com>

<http://www.luxmanual.com>

<http://aubethermostatmanual.com>

Golf course search by state

<http://golfingnear.com>

Email search by domain

<http://emailbydomain.com>

Auto manuals search

<http://auto.somanuals.com>

TV manuals search

<http://tv.somanuals.com>