

Panasonic

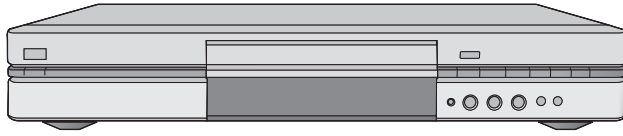

DVD Video Recorder Operating Instructions

Model No. **DMR-E51**
Model No. **DMR-E50**



G-CODE **G-CODE**®

Before connecting, operating or adjusting this product,
please read these instructions completely.
Please keep this manual for future reference.

Contents

Contents	2
Control reference guide	4
Remote control	4
Main unit	4
The unit's display	5
Warning and Important Information	6
The remote control	7
Batteries	7
Use	7
Television operation	7
Discs	8
Discs you can use	8
Discs you can use for recording and play	8
Play-only discs	8
Discs that cannot be played	9
Audio format logos	9
Types of disc for the type of connected TV	9
Connecting and Setting up	10
Auto Setup	12
Selecting TV screen type	12
Playing discs	13
Erasing a programme that is being played	13
Quick View (Play X1.3)	14
Starting play from where you stopped it (Resume Function)	14
Fast forward and rewind—SEARCH	14
Slow-motion play	14
Frame-by-frame viewing	14
Skipping	15
Starting play from a selected programme, title, chapter or track	15
Manual Skip	15
Selecting an amount of time to skip—Time Slip	15
Changing audio	16
Marking places to play again—MARKER	17
Using menus to play MP3 discs	18
Recording television programmes	19
Flexible recording mode (FR)	20
One Touch Recording—Specify a time to stop recording	20
Playing while you are recording	21
Playing from the beginning of the programme you are recording—Chasing play	21
Simultaneous recording and play	21
Checking the recording during recording (TIME SLIP)	22
Watching the television while recording	22
Using the FUNCTIONS window	22
About the FUNCTIONS window	22
Using the FUNCTIONS window	22
Timer recording	24
Using G-CODE number to make timer recording	24
Manual programming	26
To check programmes	27
Starting and canceling programmes	27
To clear a timer recording programme	27
Recording from a video cassette player	28
Entering titles	29
DISC INFORMATION	29
Enter Title	29
Disc Protection	30
Releasing disc protection	30
Erase all programmes	31
Format	31
Finalize—Creating DVD-Video	32
Using the DIRECT NAVIGATOR	33
Selecting programmes to play	33
Erasing programmes	34
Entering and editing programme titles	34
Checking programme contents	34
Protecting programmes	35
Releasing programme protection	35
Erasing parts of a programme	36
Dividing programmes	36
Using PLAY LIST to edit programmes	37
Displaying PLAY LIST	37
Creating PLAY LIST	38
Playing PLAY LIST	39
Playing Scenes	39
Adding Scenes to a PLAY LIST	40
Moving a Scene	40
To re-edit a PLAY LIST Scene	41
Erasing a Scene from a PLAY LIST	41
Copying PLAY LIST	42
Erasing a PLAY LIST	42
Titling PLAY LIST	42
Checking PLAY LIST's contents	42
Using DISPLAY menus	43
Common procedures	43
Disc menu	43
Play menu	44
Picture menu	44
Sound menu	44
Repeat play	45
Child Lock	46
To activate the Child Lock	46
To cancel the Child Lock	46
Upgrading your system	46
Enjoying more powerful sound	46
Connecting a digital amplifier or system component [A]	47
Connecting an analog amplifier or system component [B]	47
Connecting a Television with Component video input terminals (For NTSC TV System only)	48
Connecting a video cassette recorder	49
Changing the unit's settings	50
Common procedures	50
Summary of settings	51
Entering a password (Ratings)	54
Digital output	54
Remote Setting	55
Operating other Panasonic DVD equipment with the remote control	55
Clock Settings	56
Channel Settings	56
Country Settings (DMR-E50GN only)	58
Shipping Condition	58
Status displays	59
Changing the information displayed	59
Display examples	59
Maintenance and Handling	60
Maintenance	60
Disc handling	60
Glossary	61
Self-diagnosis	63
Error displays	64
Troubleshooting guide	65
Specifications	68
Index	Back cover

Keep this page open as you read through the Operating Instructions. Refer to it for the control and component names and numbers which appear in the text.

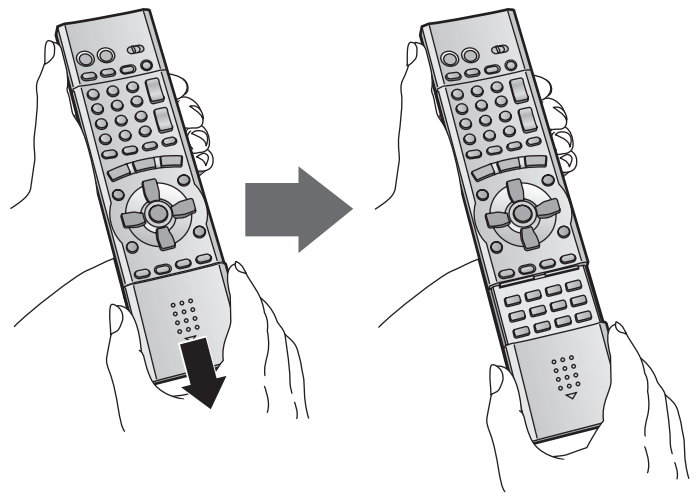
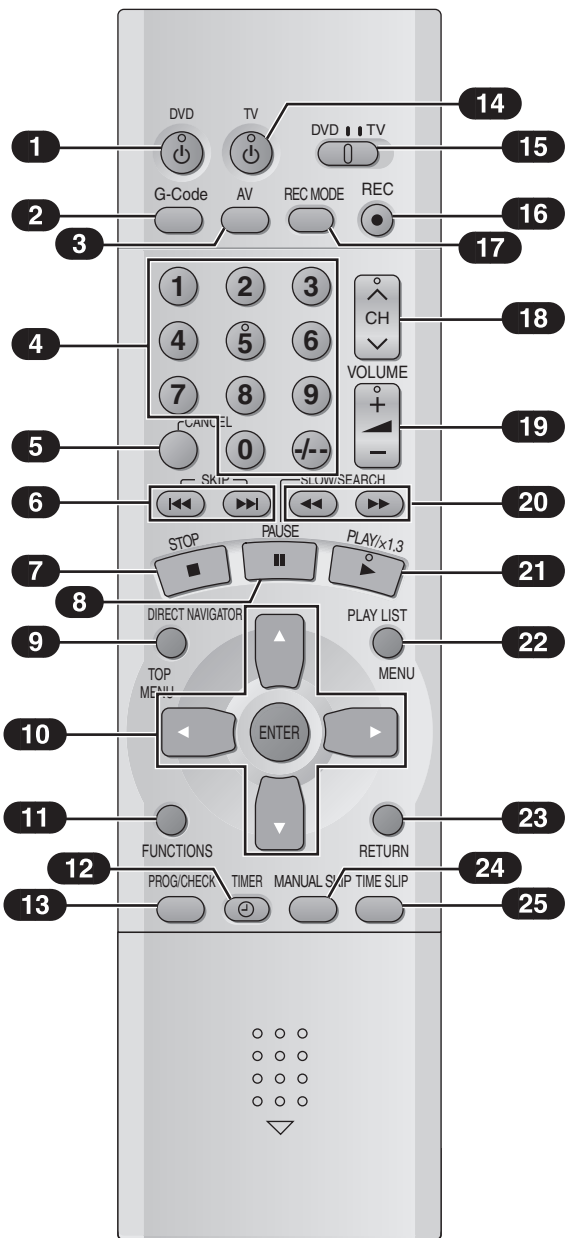
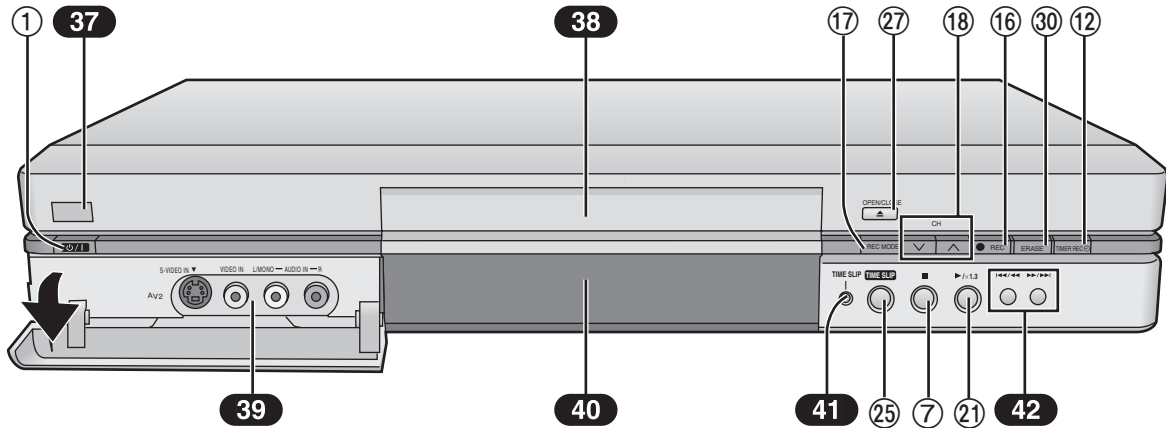

Hold both sides of the remote control's cover to open it. (You can also open it by pressing on the center of it and sliding it down.)

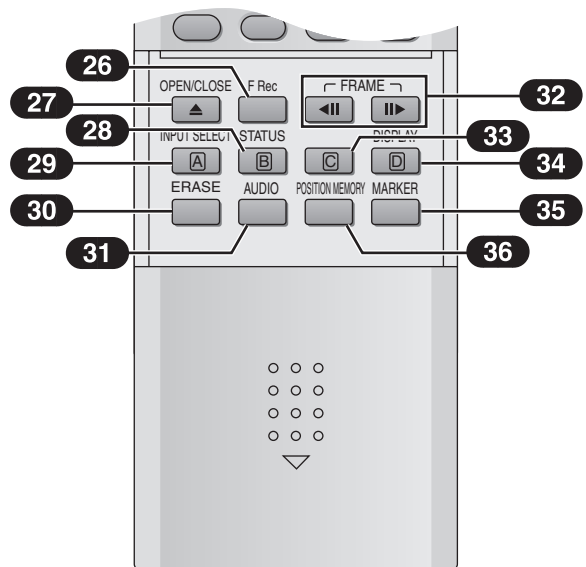

Control reference guide

Remote control

	Page
1 DVD on/off button (⏻, DVD)	12
• To switch the unit from on to standby mode or vice versa. In the standby mode, the unit is still connected to the mains.	
• In standby mode, the unit is still consuming a small amount of power.	
2 G-CODE button (G-Code)	24
3 Television input mode selector (AV)	7
4 Numeric buttons (0–9, – / –)	7
• When selecting a title, chapter, track, programme or play list	
Example: “5”: [0] → [5]	
Example: “15”: [1] → [5]	
• When selecting a page of play list scene and item of MP3	
Example: “5”: [0] → [0] → [5]	
Example: “15”: [0] → [1] → [5]	
• When selecting a television channel	
Example: “5”: [5]	
Example: “15”: [-/-] → [1] → [5]	
5 Cancel button (CANCEL)	17
6 Skip buttons (⏮, ⏭, SKIP)	15
7 Stop button (■, STOP)	13
8 Pause button (⏸, PAUSE)	13
9 Direct Navigator and Top menu button (DIRECT NAVIGATOR, TOP MENU)	13, 33
10 Cursor buttons (▲, ▼, ◀, ▶) Enter button (ENTER)	13
11 Function button (FUNCTIONS)	22
12 Timer recording button (⌚, TIMER)	24
13 Manual programming and check button (PROG/CHECK)	26
14 TV on/off button (⏻, TV)	7
15 DVD/TV switch (DVD, TV)	7
16 Recording button (●, REC)	19
17 Recording mode button (REC MODE)	19
18 Channel up/down buttons (▲, ▼, CH)	19
19 TV volume up/down buttons (+, -, VOLUME)	7
20 Slow/Search buttons (⏮, ⏭, SLOW/SEARCH)	14
21 Play/×1.3 button (▶, PLAY/×1.3)	13
22 Play List and Menu button (PLAY LIST, MENU)	13, 37
23 Return button (RETURN)	12
24 Manual skip button (MANUAL SKIP)	15
25 Time slip button (TIME SLIP)	22
26 Flexible recording button (F Rec)	20
27 Disc tray open/close button (⏏, OPEN/CLOSE)	13
28 Status display button (STATUS/ [B] button	57, 59
29 Input select button (INPUT SELECT/ [A] button	28, 57
30 Erase button (ERASE)	13, 39
31 Audio button (AUDIO)	16
32 Frame advance and frame reverse buttons (◀◀, ▶▶, FRAME)	14
33 [C] button	57
34 Display button (DISPLAY)	43
35 Marker button (MARKER)	17
36 Position memory button (POSITION MEMORY)	14

Main unit

	Page
37 Remote control signal sensor	7
38 Disc tray	13
39 AV2 input terminals (AV2)	49
40 Display	5
41 Time slip indicator (TIME SLIP)	
• While both recording and play are activated, this indicator lights up.	
42 Skip/Slow/Search buttons (⏮/◀◀, ▶▶/⏭)	14

Buttons such as ① function the same as the controls on the remote control.

Entering titles

(page 29)

- To enter characters

Use [▲, ▼, ◀, ▶] 10 to select the character you want to enter and press [ENTER] 10.

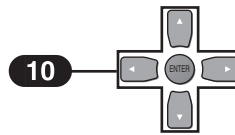

- To erase characters

Press [⏸] 8. (You can also erase characters by using [▲, ▼, ◀, ▶] 10 to select “ERASE” and pressing [ENTER] 10.)

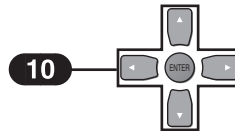

- To finish entering the title

Press [■] 7. (You can also finish entering the title by using [▲, ▼, ◀, ▶] 10 to select “SET” and pressing [ENTER] 10.)

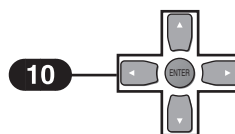

- To enter a space

You may enter a space by pressing [-/-] 4 and then press [ENTER] 10.

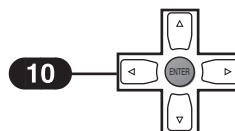

The unit's display

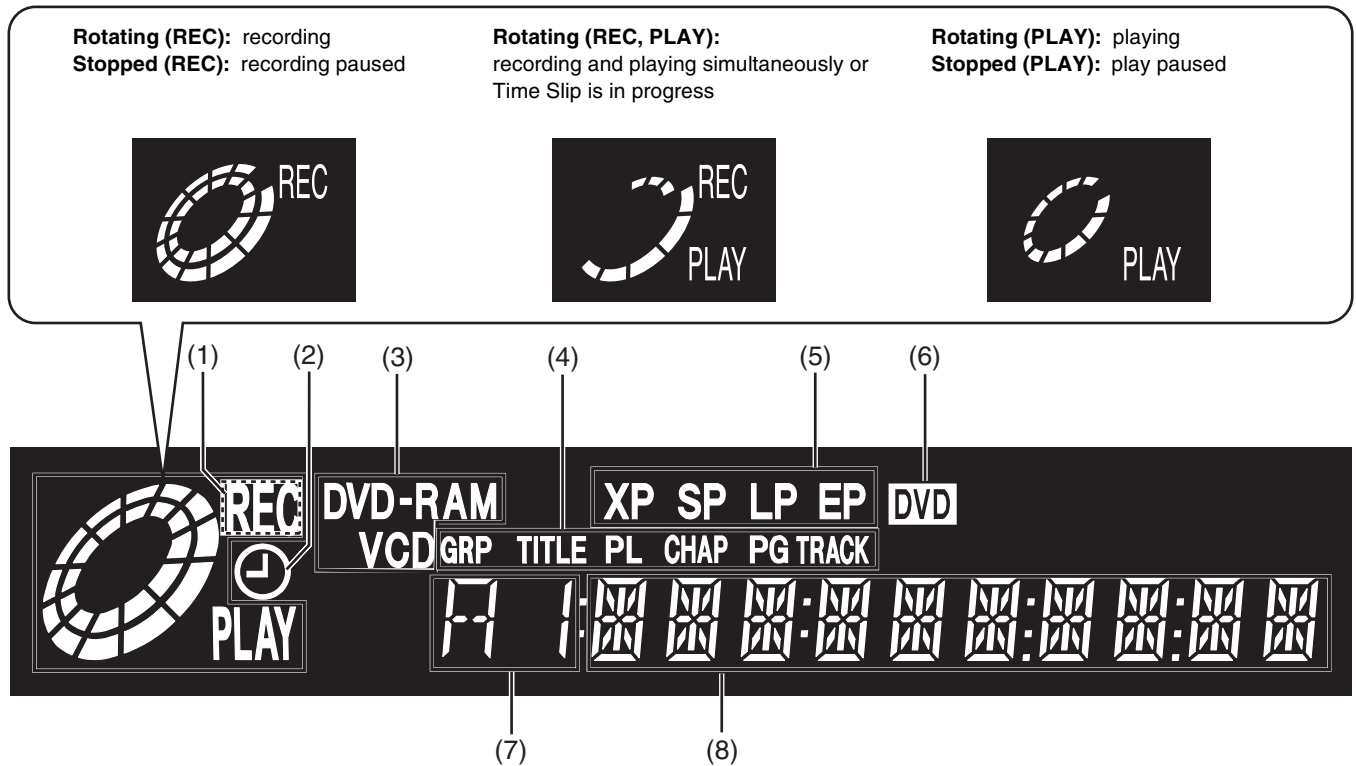

(1) Recording indicator (REC)

On:
while recording

(2) Timer programme display (PLAY)

On:
when a programme for timer recording is on

(3) Disc type

DVD-RAM: DVD-RAM
DVD-R: DVD-R
DVD-V: DVD-Video
VCD: Video CD
CD: Audio CD, MP3 disc

(4) The display mode of the main display section

GRP: group number
TITLE: title number
TRACK: track number
CHAP: chapter number
PG: programme number
PL: play list number

(5) Recording mode (pages 19 and 25)

XP: High-quality mode
SP: Normal mode
LP: Long play mode
EP: Extra long play mode
XP SP LP EP (all on):
FR mode (in flexible recording or in timer recording)

(6) DVD indicator

Flashes:
when you press [⏻, DVD] **1** to turn the unit off until it actually turns off

(7) Channel

1, 2, 3, ..., 99 / A1, A2, A3,

(8) Main display section

Timer recording
Recording and play counter
Remaining recording time
Current time
Title, track, chapter, group
Miscellaneous messages
etc.

• Remaining recording time:

(For example)

1 hour → Displayed as "R 1:00"

Warning and Important Information

CAUTION!

THIS PRODUCT UTILIZES A LASER. USE OF CONTROLS OR ADJUSTMENTS OR PERFORMANCE OF PROCEDURES OTHER THAN THOSE SPECIFIED HEREIN MAY RESULT IN HAZARDOUS RADIATION EXPOSURE. DO NOT OPEN COVERS AND DO NOT REPAIR YOURSELF. REFER SERVICING TO QUALIFIED PERSONNEL.

WARNING:

TO REDUCE THE RISK OF FIRE, ELECTRIC SHOCK OR PRODUCT DAMAGE, DO NOT EXPOSE THIS EQUIPMENT TO RAIN, MOISTURE, DRIPPING OR SPLASHING AND ENSURE THAT NO OBJECTS FILLED WITH LIQUIDS, SUCH AS VASES, SHALL BE PLACED ON THE EQUIPMENT.

As this equipment gets hot during use, operate it in a well ventilated place; do not install this equipment in a confined space such as a book case or similar unit.

Important

Your attention is drawn to the fact that the recording of pre-recorded tapes or discs or other published or broadcast material may infringe copyright laws.

For your safety

Do not remove outer cover.

Touching internal parts of the unit is dangerous, and may seriously damage it.

To prevent electric shock, do not remove cover. There are no user serviceable parts inside. Refer all servicing to qualified service personnel.

Disposal of old equipment

Batteries, packaging and old equipment should not be disposed of as domestic waste, but in accordance with the applicable regulations.



Cautions before you operate this unit

- Do not place in an enclosed area so that the rear cooling fan and the cooling vents on the side are covered up.

Avoid:

- Humidity and dust.
- Extreme heat such as direct sunlight.
- Magnets or electromagnetic objects.
- Touching internal parts of the unit.
- Water or some other liquid.
- Lightning. (Disconnect the aerial plug from the unit during lightning storms.)
- Anything heavy on the unit.
- Connecting or handling the equipment with wet hands.
- Using a cell phone near the unit because doing so may cause noise to adversely affect the picture and sound.

Do:

- Wipe the unit with a clean and dry cloth.
- Install the unit in a horizontal position.
- Keep the unit, TV and other equipment switched off until you have finished all connections.

G-CODE is a trademark of Gemstar Development Corporation. The G-CODE system is manufactured under license from Gemstar Development Corporation.

G-CODE is a registered trademark of Gemstar Development Corporation. The G-CODE system is manufactured under license from Gemstar Development Corporation.

MPEG Layer-3 audio decoding technology licensed from Fraunhofer IIS and Thomson multimedia.

Notes on these instructions

These operating instructions describe operations mainly using the remote control. If the name of the button is the same, the operation described can also be performed with the main unit.

The contents of the screens used in these instructions may not necessarily match what you will see on your screen.

Displays

The displays shown in these instructions are examples only. Actual displays depends on the disc being played.

Manufactured under license from Dolby Laboratories.

“Dolby”, “Pro Logic” and the double-D symbol are trademarks of Dolby Laboratories.

“DTS” and “DTS Digital Out” are trademarks of Digital Theater Systems, Inc.

Standard Accessories

- 1 pc. RF Coaxial cable**
- 1 pc. Remote Control (EUR7615LC0)**
- 2 pcs. R6 size batteries**
- 1 pc. AC mains lead**
- 1 pc. Audio/Video cable**



Inside of unit

DANGER	- VISIBLE AND INVISIBLE LASER RADIATION WHEN OPEN. AVOID DIRECT EXPOSURE TO BEAM. (FDA 21 CFR)
CAUTION	- VISIBLE AND INVISIBLE LASER RADIATION WHEN OPEN. AVOID EXPOSURE TO BEAM. (IEC60825-1)
ATTENTION	- RAYONNEMENT LASER VISIBLE ET INVISIBLE EN CAS D'OUVERTURE. EXPOSITION DANGEREUSE AU FAISCEAU.
ADVARSEL	- SYNLIG OG USYNLIG LASERSTRÅLING VED ÅBNING. UNDGÅ UDSÆTTELSE FOR STRÅLING.
VARO!	- AVATTAESSA OLET ALTTIINA NÄKYMÄTÖN LASERSÄTEILYLLE. ÄLÄ KATSO SÄTEESEEN.
VARNING	- SYNLIG OCH OSYNLIG LASERSTRÅLNING NÄR DENNA DEL ÄR ÖPPNAD. BETRakta EJ STRÅLEN.
ADVARSEL	- SYNLIG OG USYNLIG LASERSTRÅLING NÄR DEKSEL ÄPNES. UNNGÅ EKSPONERING FOR STRÅLEN.
VORSICHT	- SICHTBARE UND UNSICHTBARE LASERSTRÄHLUNG, WENN ABDECKUNG GEÖFFNET. NICHT DEM STRAHL AUSSETZEN.
注意	- 打开时有可见及不可见激光辐射。避免激光束照射。
注意	- ここを開くと可視及び不可視のレーザー光が出ます。ビームを直接見たり、触れたりしないでください。 RQLS0233

The remote control

Batteries

- Insert so the poles (⊖ and ⊕) match those in the remote control.
- Do not use rechargeable type batteries.

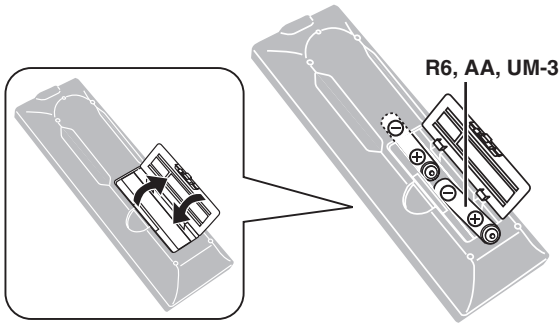

Do not;

- mix old and new batteries
- use different types at the same time
- heat or expose to flame
- take apart or short circuit
- attempt to recharge alkaline or manganese batteries
- use batteries if the covering has been peeled off

Mishandling of batteries can cause electrolyte leakage which can damage items the fluid contacts and may cause a fire. If electrolyte leaks from the batteries, consult your dealer. Wash thoroughly with water if electrolyte comes in contact with any part of your body.

Remove if the remote control is not going to be used for a long period of time. Store in a cool, dark place. Replace if the unit does not respond to the remote control even when held close to the front panel.

Use

Aim at the sensor, avoiding obstacles, at a maximum range of 7 m directly in front of the unit.

- Keep the transmission window and the unit's sensor free from dust.
- Operation can be affected by strong light sources, such as direct sunlight, and the glass doors on cabinets.

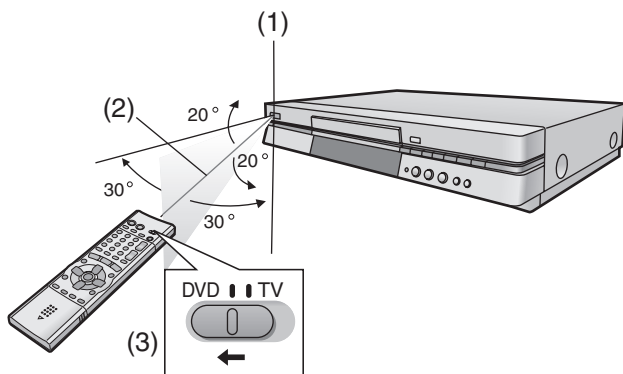

- (1) Remote control signal sensor
- (2) 7 m directly in front of the unit.
- (3) Switch [DVD, TV] **15** to "DVD".

Do not;

- put heavy objects on the remote control
- take the remote control apart
- spill liquids onto the remote control

Television operation

You can control televisions by changing the remote control code.

Preparation

- Turn on the television.
- Switch [DVD, TV] **15** to "TV".

- 1 Refer to the chart below for the code for your television.
- 2 Press and hold [TV, **14**] and enter the two-digit code with the numeric buttons **4**.
 - For example: 01, press [0]→[1].
 - After entering the code, test the remote control by turning on the television and changing channels.

Notes

- If there is more than one code, repeat the procedure until you find the code that allows correct operation.
- Repeat this procedure after you change the batteries.
- If your television brand is not listed or if the code listed for your television does not allow control of your television, this remote is not compatible with your television.

List of TVs Compatible with the unit's Remote Control

Brand:	Code
Panasonic/National	01, 02, 03, 04
SONY	05
TOSHIBA	06
JVC	07
HITACHI	08
MITSUBISHI	09, 10
SHARP	11
PHILIPS, SAMSUNG	12
NEC	13
SANYO	14
GOLDSTAR/LG	15, 16
SAMSUNG	17, 18
SANYO	19

Operation:

On and off:	[TV, 14]
Video input mode:	[AV] 3
Channels:	[^, v, CH] 18
Volume:	[+, -, VOLUME] 19
Numeric:	[0-9, -/-] 4

Button

Discs

Discs you can use

The features you can use with the different types of discs are indicated as follows.

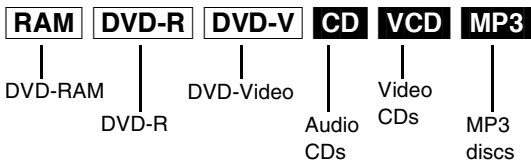



For your reference

- **DVD-R** indicates DVD-R that have not yet been finalized (page 32) and can still be recorded on.
- DVD-R that have been finalized can use the same features as DVD-Video. (Refer to features indicated **DVD-V**.)

Discs you can use for recording and play

Logos for the discs you can record on and play

Disc type	Logo	Regulation	Indication used in instructions
DVD-RAM		4.7 GB/9.4 GB, 12 cm (5") 2.8 GB, 8 cm (3")	RAM
DVD-R		4.7 GB, 12 cm (5") 1.4 GB, 8 cm (3") for General Ver.2.0	DVD-R

The manufacturer accepts no responsibility and offers no compensation for loss of recorded or edited material due to a problem with the unit or disc, and accepts no responsibility and offers no compensation for any subsequent damage caused by such loss.

Examples of causes of such losses are

- (1) A disc recorded and edited with this unit is played in a DVD recorder or computer disc drive manufactured by another company.
- (2) A disc used as described in (1) and then played again in this unit.
- (3) A disc recorded and edited with a DVD recorder or computer disc drive manufactured by another company is played in this unit.

Notes

- This unit is compatible with the Content Protection for Recordable Media (**CPRM**) system so you can record broadcasts that allow one copy, such as some CATV broadcasts, onto 4.7 GB/9.4 GB DVD-RAM (these are CPRM compatible). It is not possible to record onto DVD-R or 2.8 GB DVD-RAM.
- Do not allow the disc to become dirty or scratched. Fingerprints, dirt, dust, and scratches on the recording surface may make it impossible to use the disc for recording.
- If you use DVD-RAM cartridges, you can protect your recordings with the write protected tab (page 64). With the tab in this position, you cannot record to the disc, delete programmes with the direct navigator, edit with the play list screen, or format the disc.
- This unit is compatible with both non-cartridge and cartridge DVD-RAM, but cartridge-type discs give better protection to your valuable recordings.



For your reference

- **DVD-RAM recorded on this unit cannot be played on incompatible players (including players manufactured by Panasonic).**
- Using a Panasonic DVD-RAM, you can record broadcasts that allow you to make one copy, such as some satellite broadcasts.
- This unit cannot record PAL signals to discs containing NTSC signals or vice versa.

- This unit cannot record to discs containing both PAL and NTSC signals. Play of discs recorded with both PAL and NTSC on another unit is not guaranteed.

Play-only discs

Discs you can play-only and their logos

Disc type	Logo	Video system	Indication used in instructions
DVD-Video		PAL/NTSC	DVD-V
Audio CD		—	CD
Video CD		PAL/NTSC	VCD
CD	—	—	MP3

Region Management Information (DVD-Video only)

Region number are allocated to DVD players and software according to where they are sold.

- **For Asia: "3"**
- **For Australia, New Zealand: "4"**

DVD-Video can be played on this unit if their region number is the same or includes the same number, or if the DVD is marked "ALL". Confirm the region number for this unit before choosing discs. The number for this unit is indicated on the rear panel of the unit.

Playing CD-R and CD-RW

This unit can play CD-DA (digital audio), MP3 and Video CD format, audio CD-R and CD-RW that have been finalized* upon completion of recording.

It may not be able to play some CD-R or CD-RW due to the condition of the recording.

* Finalize: A process that allows play on compatible equipment.



Note

- The producer of the material can control how these discs are played. This means that you may not be able to control play of a disc with some operations described in these operating instructions. Read the disc's instructions carefully.

Discs that cannot be played

- DVD-Video with a region number other than the number for this unit or "All"
- Some DVD-R
- DVD-RAM (2.6 GB/5.2 GB)
- DVD-ROM
- DVD-RW
- DVD-Audio
- +RW
- CD-ROM
- CDV
- CD-G
- CVD
- SVCD
- SACD
- MV-Disc
- PD
- Photo CD
- Divx Video Disc, etc.
- Play of non-standard Video CDs and Super Video CDs is not guaranteed.

DVD-R

You can play DVD-R on compatible DVD players by finalizing [the process that allows recordings on DVD-R to be played on compatible DVD players, (page 32)] them on this unit, effectively making them into DVD-Video.

Before finalizing

You can record onto the available space on the disc and perform editing functions, such as giving titles to discs and programmes and erasing programmes.

You cannot record to or edit DVD-R with this unit if it was recorded with another unit, whether it is finalized or not.

You cannot record over parts that have been recorded.

Erasing programmes will not increase the disc's available time.

After finalizing

The video and audio is recorded according to the DVD-Video specifications, and your very own DVD-Video is created.

- The titles you entered with this unit appear as menus.
 - Programmes longer than 5 minutes are divided into 5-minute chapters.
 - These DVD-R can no longer be recorded on or edited.
 - These DVD-R can be played on other DVD players, but this is not guaranteed.
- Play may not be possible due to the player you are using, the DVD-R, or the condition of the recording. Use this unit to play the disc if the player is unable.

For your reference

- It takes about 30 seconds for the unit to complete recording management information after recording finishes.
- To record on DVD-R, this unit optimizes the disc for each recording. Optimizing is carried out when you start recording after inserting the disc or turning the unit on. Recording may become impossible after the disc is optimized more than 50 times.
- The first 30 seconds of a programme may not be recorded if you make successive timer recordings.
- The video is recorded in a 4:3 aspect irrespective of the video signal input. Use the television's screen modes to change the screen size for play.
- Some broadcasts carry signals that allow you to make one copy, but you cannot record these broadcast with DVD-R. Use DVD-RAM to record these kinds of broadcast.
- Play may be impossible in some cases due the condition of the recording.
- We recommend using DVD-R manufactured by Panasonic as they have been tested to be compatible with this unit.
- You cannot change audio type if a DVD-R is in the unit. Select the audio type (M1 or M2) before recording by going to "Bilingual Audio Selection" in the "Sound" menu.

Audio format logos



Dolby Digital (pages 46 and 61)

This unit can play Dolby Digital in stereo (2 channels). Connect an amplifier with a built-in Dolby Digital decoder to enjoy surround sound.



DTS Digital Surround (pages 46 and 61)

Connect this unit to equipment that has a DTS decoder to enjoy DVDs with this mark.

Types of disc for the type of connected TV

When you use the discs recorded either PAL or NTSC, refer to this table.

TV type	Disc	Yes/No
Multi-system TV	PAL	Yes
	NTSC	Yes
NTSC TV	PAL	No
	NTSC	Yes*1
PAL TV	PAL	Yes
	NTSC	Yes*2 (PAL60)

*1 If you select "NTSC" in "TV System" (page 53), the picture may be clearer.

*2 If your television is not equipped to handle PAL 525/60 signals the picture will not be shown correctly.

Discs and accessories

DVD-RAM

You can also record signals which allow you to make one copy, onto these discs.

9.4-GB, double-sided, type 4 cartridge:

LM-AD240E

4.7-GB, single-sided, type 2 cartridge:

LM-AB120E

(set of 3, LM-AB120E3)

4.7-GB, single-sided, non-cartridge:

LM-AF120E

(set of 3, LM-AF120E3)

DVD-R

4.7-GB, single-sided, non-cartridge:

LM-RF120E

DVD-RAM/PD Disc cleaner:

LF-K200DCA1

DVD-RAM/PD Lens cleaner:

LF-K123LCA1

Connecting and Setting up

First of all, please disconnect AC mains leads of all units which you are going to connect with before connecting and disconnecting cables.

Use an Audio/Video cable or Audio/S-Video cable.

Follow these steps if you connect your unit to a television using an RF Coaxial cable and an Audio/Video cable. (AV Connection)

An RF Coaxial cable must be connected to watch television even if an Audio/Video cable is also used to connect unit to the television

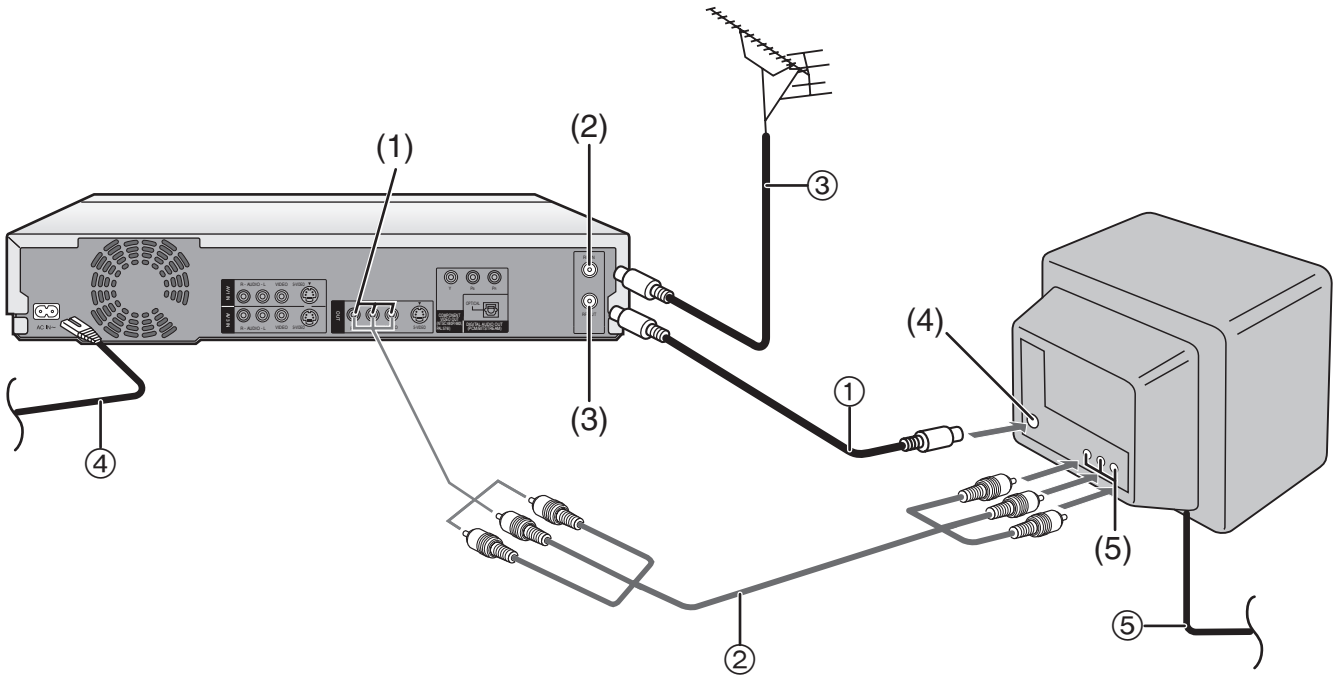

Connect as following steps

- ① RF Coaxial cable (supplied)
- ② Audio/Video cable (supplied)
- ③ Aerial lead (not supplied)
- ④ AC mains leads (supplied)
- ⑤ AC mains leads (not supplied)

Sockets

- (1) Audio/Video Output socket
- (2) Aerial Input socket
- (3) Aerial Output socket
- (4) Aerial Input socket
- (5) Audio/Video Input socket

Follow these steps if you connect your unit to a television using an S-Video cable. (S-Video Connection)
 An RF Coaxial cable must be connected to watch television.

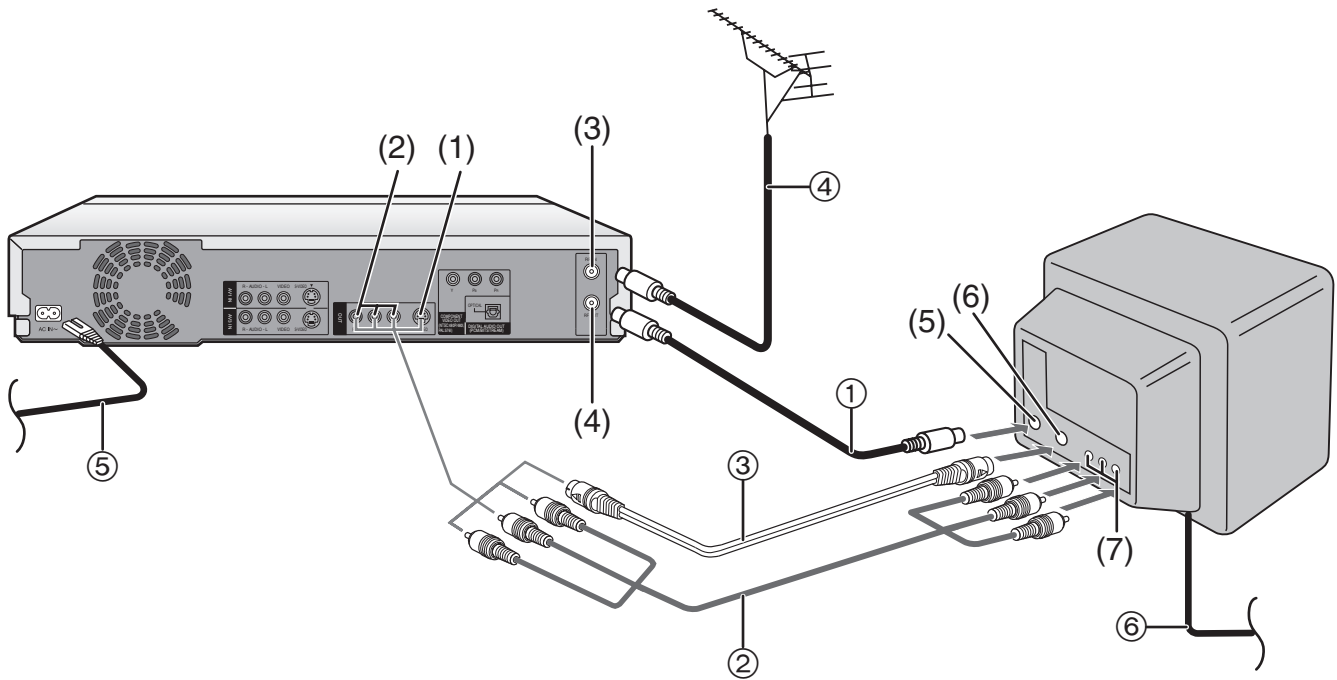

Connect as following steps

- ① RF Coaxial cable (supplied)
- ② Audio/Video cable (supplied)
- ③ S-Video cable (not supplied)
- ④ Aerial lead (not supplied)
- ⑤ AC mains leads (supplied)
- ⑥ AC mains leads (not supplied)

Sockets

- (1) S-Video Output socket
- (2) Audio/Video Output socket
- (3) Aerial Input socket
- (4) Aerial Output socket
- (5) Aerial Input socket
- (6) S-Video Input socket
- (7) Audio/Video Input socket

Do not connect the unit through a video cassette recorder
 Video signals fed through video cassette recorders will be affected by copyright protection systems and the picture will not be shown correctly on the television.

Auto Setup

Auto Setup automatically tunes all available stations.

- 1 Press [DVD,] **1** to switch the unit on.
DMR-E51GCS: Auto-Setup screen appears on the television and go to step 3.
DMR-E50GN: The Country setting menu appears on the television.

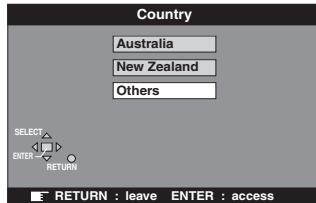

- 2 Use [**▲**, **▼**, **◀**, **▶**] **10** to select the country and press [ENTER] **10**.
- 3 Auto Setup starts.
 • This takes about 5 minutes.



To cancel Auto Setup before it finishes

Press [RETURN] **23**.

The clock setting menu appears after Auto Setup finishes

- (1) Use [**▲**, **▼**, **◀**, **▶**] **10** to set the correct time and date.
- (2) Press [ENTER] **10** to conclude the setting.

To confirm that stations have been tuned correctly

See page 56.

When no stations have been set, confirm all connections and restart Auto Setup

See page 57 and Hint below.

When station names or channel numbers have not been set correctly

See page 56.

Hint

- You can restart the Auto Setup if the screen of the unit's tuner is displayed in the stop mode. Hold down [**▲**, CH] **18** and [**▼**, CH] **18** on the main unit simultaneously for about 5 seconds.

Selecting TV screen type

The aspect ratio is factory set to 4:3 for a regular television. You do not have to change this setting if you have a regular 4:3 aspect television.

Preparation

- Turn on the television and select the appropriate video input to suit the connections to this unit.
- Switch [DVD, TV] **15** to "DVD".

- 1 Press [DVD,] **1** to turn this unit on.
- 2 Press [FUNCTIONS] **11** to show the FUNCTIONS window.
- 3 Use [**▲**, **▼**, **◀**, **▶**] **10** to select "SETUP" and press [ENTER] **10**.

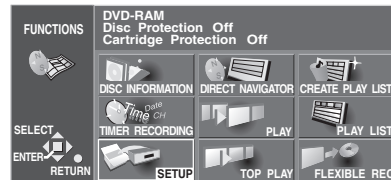

- 4 Use [**▲**, **▼**] **10** to select the "Connection" and press [**◀**] or [**▶**] **10**.
- 5 Use [**▲**, **▼**] **10** to select "TV Aspect" and press [ENTER] **10**.

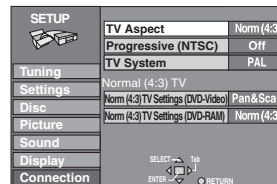

- 6 Use [**▲**, **▼**] **10** to select the TV aspect and press [ENTER] **10**.

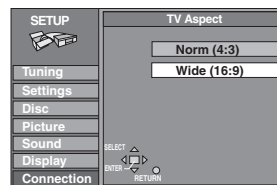

- 4:3 (factory setting)
- 16:9

To return to the previous screen

Press [RETURN] **23**.

For your reference

Apart from "TV Aspect", other settings also affect how video appears on your television. Check the following if video doesn't appear correctly on your television.

- "Connection"—"Norm (4:3) TV Settings (DVD-Video)" or "Norm (4:3) TV Settings (DVD-Video)" (page 53).
- The video setting on the disc. How video appears is often specified by the disc itself.
- The video settings on your television.

Playing discs

RAM DVD-R DVD-V CD VCD MP3

Preparation

Switch [DVD, TV] **15** to "DVD".

- 1 Press [DVD,] **1** to turn the unit on.
- 2 Press [, OPEN/CLOSE] **27** to open the tray and insert a disc.

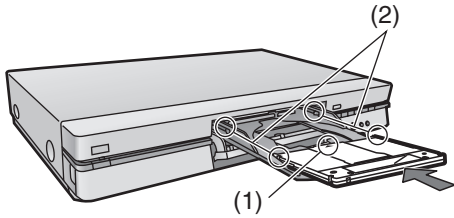

e.g.: DVD-RAM

- (1) Arrow pointing inwards.
- (2) Align correctly.
 - Insert label-up with the arrow facing in. (With double-sided discs, load so the label for the side you want to play is facing up.)
 - Insert inside the tray's guides.
 - Insert one disc only.

- 3 Press [, **21**].

- The disc tray closes and play begins. (The unit takes some time to read the disc before play starts.)
- If the Resume function (page 14) is not active, playback will begin from the most recently recorded programme. **RAM DVD-R**
- Play starts from the beginning of the disc. **DVD-V CD VCD MP3**
- If you insert a DVD-RAM with the write-protect tab set to "PROTECT" (page 64) and press [, OPEN/CLOSE] **27**, play starts automatically.



To stop play

Press [, **7**]. (page 14, "Starting play from where you stopped it")

- A screen similar to the illustrated may appear when you stop play. Press [, **7**] again and you can use this unit's tuner to watch television.

This screen is also shown when you are playing CDs.



To pause play

Press [, **8**].

Press again to restart playing.

With non-cartridge discs

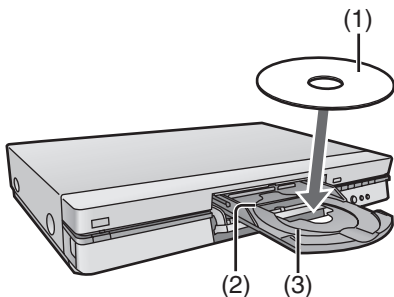

- (1) Insert label-up. (With double-sided discs, load so the label for the side you want to play is facing up.)
- (2) Guide for 12 cm (5") disc
- (3) Guide for 8 cm (3") disc

When a menu screen appears on the television

DVD-V VCD

Operate menus with the following operations. Actual operations depend on the disc.

- Press the numeric buttons **4** to select an item, or move [, , , , **10**] to select an item and press [ENTER] **10**.
- You can return to menus after you start play by pressing [TOP MENU] **9** or [MENU] **22** (DVD-Video), or [RETURN] **23** (Video CD).

Note

- The disc continues to rotate while the menu is displayed even after you finish playing an item. Press [, **7**] when you finish to preserve the unit's motor and your television screen.

For your reference

- If "" appears on the television

The operation is prohibited by the unit or disc.

- **RAM DVD-R**

Play starts from the beginning of the most recent recording. If that programme is extremely short, play starts from the next most recent recording. Use "TOP PLAY" in the FUNCTIONS window (page 22) to start play from the oldest programme on the disc (programme 1).

Erasing a programme that is being played

RAM DVD-R

Since the programme in playback and all the play lists (page 38) created during its playback are erased irretrievably, you should make sure if the desired programme has been selected before carrying out.

- 1 During play

Press [ERASE] **30**.

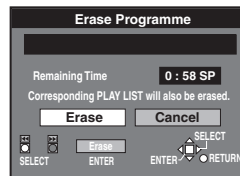

- The menu disappears about 10 seconds later.

- 2 Use [, **10**] or [, **42**] to select "Erase" and press [ENTER] **10** or [ERASE] **30**.

- Use [, **10**] or [, **42**] to select "Cancel" and press [ENTER] **10** or [ERASE] **30**, or press [RETURN] **23** to cancel.

Notes

- It is not possible to erase a programme when you are carrying out simultaneous recording and play (page 21).
- It is not possible to erase a programme that is in the process of being recorded.
- The available recording time on DVD-R does not increase when you erase programmes.

Quick View (Play ×1.3)

RAM

During play or Time Slip, you can play faster than the normal play to save time by Quick View function.

During play

Press and hold [▶] **21** for about 1 second.

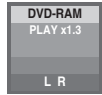

- Press [▶] **21** to return to normal play.
- You cannot use this feature if the “PLAY ×1.3 & Audio during Search” of “Sound” is “Off” (page 52).
- This feature can be activated only on DVD-RAM recorded with Dolby Digital.
- Simultaneous recording and play with Quick View (Play ×1.3) is possible only during SP, LP and EP recording mode.
- Quick View (Play ×1.3) cannot operate when “editing menu” is displayed. (pages 36, 38, 40 and 41)
- During Quick View (Play ×1.3), the Digital Audio Output will change to PCM Output.
- During Quick View (Play ×1.3), it may cause the picture to freeze for a moment when scenes change.

Starting play from where you stopped it (Resume Function)

RAM DVD-R DVD-V CD VCD MP3

1 During play

Press [■] **7**.

- The unit remembers the position.

2 Press [▶] **21**.

- Play starts from where you stopped it.



e.g.: DVD-RAM

■ To cancel the resume function

Press [■] **7** while the unit remembers the position.
(The position is also cleared when you turn the unit off.)

■ To start play from a memorized position after turning the unit off

Press [POSITION MEMORY] **36** during play.
(The message “Position Memorized” appears on the television.)
Now when you press [▶] **21** after switching the unit to standby and back on, play starts from the memorized position.

For your reference

DVD-R DVD-V CD VCD MP3

- The position memorized when you press [■] **7** or [POSITION MEMORY] **36** is cleared when you open the disc tray.

RAM

- The position memory is written to the disc and remains intact until you mark a different position.
You cannot mark positions if the disc is write-protected with DISC INFORMATION (page 30) or with the write protect tab (page 64). Release the protection before marking position.
- If you press [■] **7** before switching the unit to standby after pressing [POSITION MEMORY] **36** to memorize a position, play will resume from the position you pressed [■] **7** when you press [▶] **21**.

Fast forward and rewind—SEARCH

RAM DVD-R DVD-V CD VCD MP3

During play

Press [◀◀, SLOW/SEARCH] or [▶▶, SLOW/SEARCH]

20.

[◀◀]: backward

[▶▶]: forward



- If using the [◀◀/◀◀] or [▶▶/▶▶] **42** button on the unit, keep pressing the button for 1 or more seconds.
- There are 5 search speeds. Each press increases the search speed.
- The search speed is maintained when you release the button.
- Press [▶] **21** to return to normal play.
- You will hear sound at speed one (only forward) when playing DVD-RAM, DVD-R, DVD-Video and Video CDs. You can turn this sound off if you want to (page 52, “Sound”—“PLAY ×1.3 & Audio during Search” to “Off”).
- Sound is not heard during chasing play and simultaneous recording and play.

Slow-motion play

RAM DVD-R DVD-V VCD

While paused

Press [◀◀, SLOW/SEARCH] or [▶▶, SLOW/SEARCH]

20.

[◀◀]: backward (does not work with Video CDs)

[▶▶]: forward

- If using the [◀◀/◀◀] or [▶▶/▶▶] **42** button on the unit, keep pressing the button for 1 or more seconds.
- There are 5 slow-motion speeds. Each press increases the slow-motion speed.
- The slow-motion speed is maintained when you release the button.
- Press [▶] **21** to return to normal play.

Frame-by-frame viewing

RAM DVD-R DVD-V VCD

Remote control only

While paused

Press [◀◀◀, FRAME] or [▶▶▶, FRAME] **32** or [◀, ▶]

10.

[◀◀◀] or [◀]: backward (does not work with Video CDs)

[▶▶▶] or [▶]: forward

- Each press shows the next or previous frame.
- Press [▶] **21** to return to normal play.

Skipping

RAM DVD-R DVD-V CD VCD MP3

You can skip to the beginning of tracks (page 62) and chapters (page 62) and restart play from there.

On DVD-RAM and DVD-R, you can skip to the start of a programme and start play from there.

The section between the point where recording is started and the point where it is stopped is called a "programme".

During play or while paused

Press [**◀◀**, SKIP] or [**▶▶**, SKIP] **6**.

[**◀◀**]: backward

[**▶▶**]: forward

Each press increases the number of skips.

For your reference

- After skipping, the unit returns to the previous state, play or pause.
- Press [**▶**] **21** to restart play if it was paused.
- Pressing [**◀◀**] or [**▶▶**] **6** while a DVD menu is being shown or while the playback control feature on Video CDs (page 62) is working may take you to a menu screen.
- You can also mark positions to skip to (page 17).

DVD-V CD VCD MP3

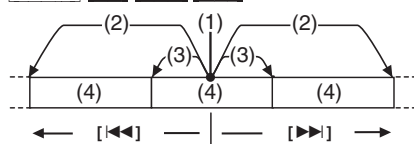

- (1) Play position
- (2) Twice
- (3) Once
- (4) Chapter/track

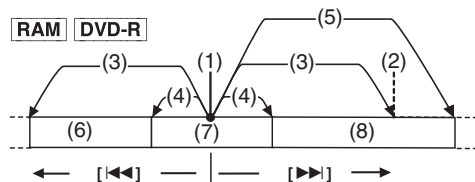

- (1) Play position
- (2) Marker
- (3) Twice
- (4) Once
- (5) Three times
- (6) The programme before
- (7) Current programme
- (8) The programme after

Starting play from a selected programme, title, chapter or track

RAM DVD-R DVD-V CD VCD MP3

Remote control only

Preparation

Switch [DVD, TV] **15** to "DVD".

During play

Press the numeric buttons **4** to select the item.

(page 4)

- This works only when stopped with some discs (the screen saver is on the television).



Manual Skip

RAM DVD-R

Remote control only

You can skip commercials easily with this feature.

Preparation

Switch [DVD, TV] **15** to "DVD".

During play

Press [**MANUAL SKIP**] **24**.

Play restarts from approximately 30 seconds later.

Selecting an amount of time to skip— Time Slip

RAM DVD-R

You can set an amount of time and then skip with one press of a button.

Preparation

Switch [DVD, TV] **15** to "DVD".

1 During play

Press [**TIME SLIP**] **25**.

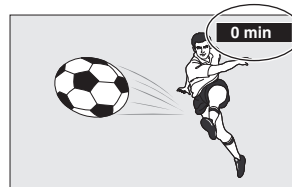

2 Within 5 seconds

Press [**▲**, **▼**] **10** to enter the time and press [**ENTER**] **10**.

- Play skips the time you entered.

- Press [**▲**] **10** to increase or [**▼**] **10** to decrease in one-minute units. Press and hold [**▲**] **10** to increase or [**▼**] **10** to decrease in 10-minute units.



Note

- You cannot use this feature while a "DIRECT NAVIGATOR" (page 33) or "PLAY LIST" (page 37) screen is being displayed.

Changing audio

RAM DVD-V VCD

Remote control only

You can change the audio being received or played with the following procedure.

Preparation

Switch [DVD, TV] **15** to "DVD".

During reception or play

Press [AUDIO] **31** to select the audio type.

How the type changes depends on when you press the button.

While receiving a TV programme with Stereo

When receiving a TV programme with the Stereo, Bilingual or NICAM sound system, the type of sound system in which it is broadcast is automatically indicated.

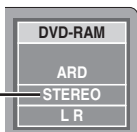

(1) e.g.: "STEREO" is selected

STEREO: When receiving a STEREO/NICAM stereo broadcast.

M1/M2: When receiving a Bilingual/NICAM dual-sound broadcast.

M1: When receiving a NICAM monaural broadcast.

While playing a television programme recorded on DVD-RAM

If it is a recording of a stereo broadcast

LR→L→R

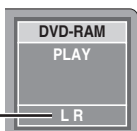

(2) e.g.: "LR" is selected

While playing a DVD Video

You can change the audio channel number each time you press the button. This allows you to change things like the soundtrack language.



(3)



(4)

(3) e.g.: English is the selected language

(4) The language is switched to French

While playing a Video CD

LR→L→R

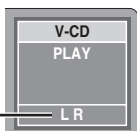

(5) e.g.: "LR" is selected

For your reference

- You can also use the DISPLAY menu to change the audio type.
- You can change the audio for the images being played with simultaneous recording and play and Time Slip.

When you have connected the unit to other equipment with an optical digital cable

You cannot change the audio type when you have used only an optical digital cable for connection in the following cases:

- While playing stereo or bilingual broadcasts recorded on DVD-RAM.
- While playing something recorded from other equipment.

When using DVD-R

You cannot use [AUDIO] **31** or the DISPLAY menu to change audio type when a DVD-R is in the disc tray.

While receiving a bilingual TV broadcast

You can use the SETUP menus to select which audio type is recorded, either "M1" or "M2". "M1" is the default setting. (page 52, "Sound"—"Bilingual Audio Selection")

During play

The audio type selected for recording is played. This is displayed as "LR".

Marking places to play again—MARKER

RAM DVD-R

You can mark up to 999 points on a disc to return to later. These marks are recorded directly onto DVD-RAM, but are cleared when you removed or finalized DVD-R.

DVD-V CD VCD MP3

You can mark up to 5 points on a disc to return to later. All the markers are cleared when the disc tray is opened.

Preparation

Switch [DVD, TV] **15** to "DVD".

Marking positions directly

During play

Press [MARKER] **35**.

- One marker is added.

Using DISPLAY menus to mark positions

Displaying the marker icon

1 During play

Press [DISPLAY] **34**.



2 Use [▲, ▼] **10** to select the Play tab and press [▶] **10**.



3 Use [▲, ▼] **10** to select "Marker" and press [▶] **10** to highlight the first asterisk (*).

RAM DVD-R

DVD-V CD VCD MP3



Marking positions

1 Use [◀, ▶] **10** to select an asterisk (*).

2 Press [ENTER] **10**.

- One marker is added.

When marking positions 11 and above

RAM DVD-R

1 Use [◀, ▶] **10** to highlight "1-10".

2 Use [▲, ▼] **10** to select "11-20".

- You can select the next group of 10 when the current group is full.

3 Use [▶] **10**.

- The first asterisk is highlighted.

4 Press [ENTER] **10** to mark a position.

To play from a marked position

1 Use [◀, ▶] **10** to select a marker number.

2 Press [ENTER] **10**.

- Play starts from the marked position.

To clear a marker

Use [◀, ▶] **10** to select a marker number and press [CANCEL] **5**.

- An asterisk replaces the number and the position is cleared.

To clear the DISPLAY menus

Press [DISPLAY] **34**.

Notes

RAM

- This feature doesn't work while using a play list.
- Markers cannot be added to or removed from discs that are protected (pages 30 and 64).

RAM DVD-R

- The markers are ordered by time. This means that the marker numbers can change when you add and erase markers.

DVD-V CD VCD MP3

- This feature only works if the elapsed playing time of the disc is shown on the unit's display.
- Some subtitles recorded around the marker may fail to appear.

Using menus to play MP3 discs

MP3

This unit can play MP3 files recorded on CD-R/RW with a computer. Files are treated as tracks and folders are treated as groups.

“Total” means total number of all MP3 files (all tracks in all groups) recorded in the disc.

Preparation

Switch [DVD, TV] **15** to “DVD”.

1 During stop or play

Press [TOP MENU] **9** or [MENU] **22**.

- The file list appears.

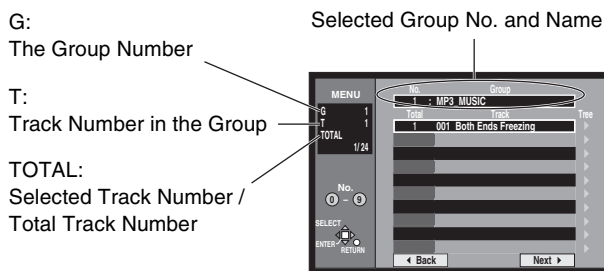

2 Press [▲, ▼] **10** to select the track and press [ENTER] **10**.

Play continues to the last track in the last group.

- “” indicates the track currently playing.
- You can also select the track with the numeric buttons **4**, directly.

e.g.: The track “006.mp3” of Group “002” of the illustration on top right,
 “6”: [0] → [0] → [6]
 The track “010.mp3” of Group “003” of the illustration on top right,
 “10” [0] → [1] → [0]

To show other pages

Press [▲, ▼, ◀, ▶] **10** to select “◀ Back” or “Next ▶” and press [ENTER] **10**.

- After listing all the tracks in one group, the list for the next group appears.

To exit the file list

Press [TOP MENU] **9**, [MENU] **22** or [RETURN] **23**.

Notes

- The order in which menu appears on menu display may differ from the order on computer display.
- Sometimes, during fast forward/rewind of VBR recorded MP3, the counter may not display correctly.
- This unit is compatible with multi-session but if there are a lot of sessions it takes more time for play to start. Keep the number of sessions to a minimum to avoid this.
- This unit cannot play files recorded using packet write.
- If the disc includes both MP3 and other types of audio data (e.g. WMA or WAV), the unit plays only the MP3.
- If the disc includes both MP3 and normal audio data (CD-DA), the unit plays the type recorded in the inner part of the disc.
- Depending on how you create MP3 files, they may not play in the order you numbered them or may not play at all.
- If you play a MP3 track that includes still picture data, it will take some time before the music itself starts playing and the elapsed time will not be displayed during this time. Even after the track starts, the correct play time will not be displayed.
- Maximum number of tracks and groups recognizable: 999 tracks and 99 groups
- Compatible compression rate: between 32 kbps and 320 kbps

Naming folders and files

At the time of recording, give folder and file names a 3-digit numeric prefix in the order you want them to play (this may not work at times).

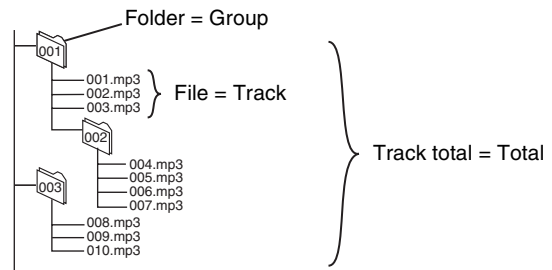

- Discs must conform to ISO9660 level 1 or 2 and Joliet (except for extended formats).
- MP3 files must have the extension “.MP3” or “.mp3”.
- This unit is not compatible with ID3 tags.
- English alphabets and a Arabic numerals are indicated properly. Other characters may not be indicated properly.

Using the tree screen to find a group

1 During stop or play

Press [▶] **10** while a track is highlighted to display the tree screen.



Selected Group Number / Total Group Number
 • If the group has no track, “— —” is displayed as group number.

- The folder which the file of MP3 is not in through is indicated by black. Even if that folder is chosen, a file list doesn’t come out.

2 Press [▲, ▼] **10** to select a group and press [ENTER] **10**.

- The file list for the group appears.

For your reference

- Press [◀, ▶] **10** to jump layers in the tree screen.

To return to the file list

Press [RETURN] **23**.

Recording television programmes

RAM **DVD-R**

Preparation

Switch [DVD, TV] **15** to "DVD".

- Press [DVD,] **1** to turn the unit on.
- Press [, OPEN/CLOSE] **27** to open the tray and insert a disc.
 - Insert one disc only within the tray's guides.
 - Use a disc that can be recorded on and that has enough space available.
 - Press [, OPEN/CLOSE] **27** to close the tray.
 - When using a DVD-RAM for the first time with this unit, format it to ensure accurate recording (page 31, "Format"). Check the disc carefully to ensure it doesn't contain programmes you want to keep.

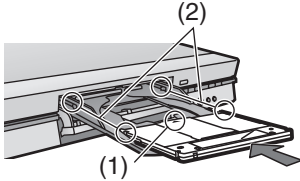

e.g.: DVD-RAM

- Arrow pointing inwards.
- Align correctly.

- Insert label-up with the arrow facing in. (with double-sided discs, load so the label for the side you want to record is facing up.)

- Press [, , CH] **18** or numeric buttons **4** to select the channel.

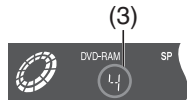

(3) e.g.: When you have selected channel 4

- Press [REC MODE] **17** to select the recording mode.

- Select "XP", "SP", "LP" or "EP".
- It is also possible to perform the flexible recording (FR). (page 20)



(4) e.g.: When you have selected "XP"

- Press [, REC] **16** to start recording.

- The programme which has already been recorded is not overwritten.



To ensure recording

- Use a disc that can be recorded on and that has enough space available.
- Ensure the write protect tab is not set to "PROTECT". (page 64)
- Ensure the disc is not write-protected with DISC INFORMATION.

To pause recording

Press [] **8**.

Press again to restart recording.

To stop recording

Press [] **7**.

To select channels with the remote control

Press the numeric buttons **4**.

Convenient features

- Chasing play—playing from the beginning of the programme you are recording (page 21).
- Simultaneous recording and play—watching a programme you recorded while recording another (page 21).
- Time Slip—checking the images you are recording (page 22).

Re-inserting double-sided discs

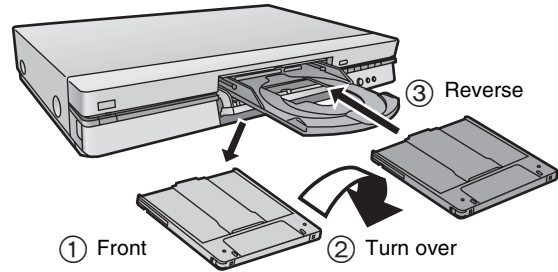

You can get up to 12 hours recording when you use double-sided discs and use the "EP" mode.

Recording modes and approximate recording times in hours

	DVD-RAM		DVD-R (4.7 GB)
	Single-sided (4.7 GB)	Double-sided (9.4 GB)	
XP (High quality)	1	2	1
SP (Normal)	2	4	2
LP (Long play)	4	8	4
EP (Extra long play)	6	12	6

- Flexible recording (FR) calculates a recording rate that will enable the recording to fit in the remaining time on the disc.

When using DVD-R

- You can play DVD-R on compatible DVD players by finalizing them on this unit, effectively making them into DVD-Video.
- The video is recorded in a 4:3 aspect irrespective of the video signal input.
- When recording bilingual channel sound onto DVD-R, it is possible to select only one of "M1" or "M2".

When recording bilingual TV broadcast while receiving a bilingual TV broadcast

Select "M1"(main) or "M2"(secondary audio) of "Bilingual Audio Selection" in the "Sound" menu.

When recording bilingual audio with connecting to a decoder or a digital receiver

Select the audio type either "M1" or "M2" on the connected devices. (You cannot select the audio type on this unit.)

For your reference

RAM

- Select the audio type both "M1" and "M2" on the connected devices. (You can also select the audio type on this unit.)

Note

DVD-R

- You cannot use [AUDIO] **31** or the DISPLAY menu to change audio type when a DVD-R is in the disc tray.

■ To check the remaining time and the current mode during recording

Press [STATUS] **(28)** several times.

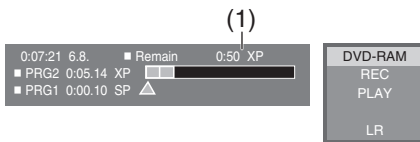

(1) Available recording time and recording mode (e.g.: "0:50 XP" indicates 50 minutes in XP mode)

Notes

- The message "Cannot record. Maximum number of programmes recorded." is displayed if you try to start recording when there are already 99 programmes on a disc. Erase unneeded programmes (DVD-RAM/DVD-R) or use a new disc to continue recording.
 - Check that disc can be recorded on (page 8).
- ### For your reference
- You can record up to 99 programmes on one disc.
 - You cannot change the channel or recording mode during recording. You can change them while recording is paused, but the material is recorded as a separate programme.
 - An error message appears if you try to start recording when a disc is full; the remaining time will be shown as "0:00". To continue recording, erase unneeded programmes (DVD-RAM only (page 34), Erasing programmes) or use another disc.
 - There are limitations when recording to DVD-R (page 9).
 - The message "Can not record on the disc." is displayed when recording was not completed correctly. Check the discs for dirt or scratches.
 - Recording cannot be performed correctly if you try to record PAL system to a disc that already contains recordings using NTSC.

Flexible recording mode (FR)

RAM DVD-R

The unit calculates a recording rate that enables the recording to fit in the time you set (within the remaining time on the disc) and with the best possible picture quality.

1 While stopped

Press [F Rec] **(26)**.



2 Press [▲, ▼, ◀, ▶] **(10)** to set the recording time.

3 To start recording

Press [▲, ▼, ◀, ▶] **(10)** to select "Start" and press [ENTER] **(10)**.

- Recording starts.

For your reference

- Press [STATUS] **(28)** during recording to show the remaining time.

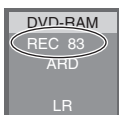

- It is not possible to change channel or recording mode while flexible recording is paused.
- Recording time reduces if you repeatedly pause recording.

One Touch Recording—Specify a time to stop recording

RAM DVD-R

Main unit only

This is a simple way of making timer recordings when you are in a hurry or before you go to bed. You can set the time up to 4 hours in advance.

While recording

Press [●, REC] **(16)** on the main unit to select the recording time.

The time increases as illustrated each time you press the button. The counter decreases in 1-minute units after you set a time. You can change the time again with the same operation. When the time you set is reached, recording stops and the unit switches to standby.

Unit's Display

(Counter) → 30 → 60 → 90
 ↑240 ← 180 ← 120 ←



(2) Shows recording will stop in 30 minutes

■ To cancel

During recording, press [●, REC] **(16)** until the counter appears.

- Recording continues.

■ To show the time remaining until recording finishes

Press [STATUS] **(28)** several times.

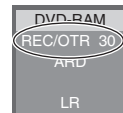

For your reference

- This does not work during timer recordings or while using flexible recording.
- You cannot use the remote control to specify a time for recording to stop.
- Recording stops and the set time is cleared if you press [■] **(7)**.
- The set time is cleared if you change the recording mode or channel while recording is paused.

Playing while you are recording

Playing from the beginning of the programme you are recording—Chasing play

RAM

You can start play from the beginning of a programme while continuing to record it.

Preparation

Switch [DVD, TV] **15** to "DVD".

While recording or timer recording

Press **[▶]** **21**.

Play starts from the beginning of the programme being recorded.

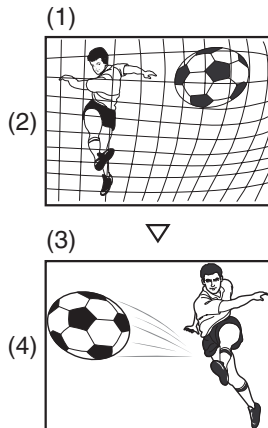

- (1) For example: while recording programme 2 (sport)
- (2) You want to watch the **sports programme** currently recording (programme 2)
- (3) Do the above operation (press **[▶]** **21**) and...
- (4) The same **sports programme** is recorded while you are watching it.

■ To stop play and recording

- 1) Press **[■]** **7**. Play stops.
- 2) (Wait 2 or more seconds)
Press **[■]** **7**. Recording stops.
 - You cannot stop recording with **[■]** **7** during timer recording. To stop timer recording, press **[⊖]**, **TIMER** **12**.

For your reference

- The playback images are displayed during chasing play.
- Sound is not output while fast-forwarding.
- Play cannot be started until at least 2 seconds after recording starts.
- If you fast-forward and get to within a few seconds of the part being recorded, the picture will change to show the images currently being played.
- The operation is shown on the unit's display (page 5).
- If you fast-forward and get to within a few seconds of the part being recorded, the unit automatically switches to play and shows the images about 5 seconds before. You cannot get any closer than this.
- While this function is activated, **TIME SLIP** indicator **41** lights up.

Simultaneous recording and play

RAM

You can start play of the programme you are recording or play a programme previously recorded.

Preparation

Switch [DVD, TV] **15** to "DVD".

During recording or timer recording

1 Press **[DIRECT NAVIGATOR]** **9**.

- "●" is displayed in the direct navigator to indicate the programme is being recorded (page 33).

2 Use **[▲]**, **[▼]** **10** to select a programme and press **[ENTER]** **10**.

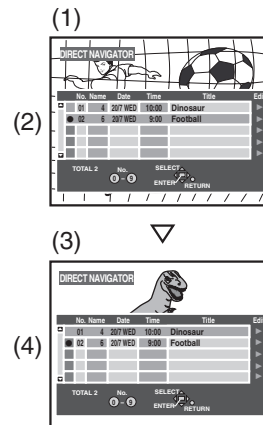

- (1) For example: while recording programme 2 (sport)
- (2) You want to watch the **movie** you recorded yesterday (programme 1)
- (3) Do the above operation and...
- (4) A **sports programme** is recorded while you watch a **movie**.

■ To stop play and recording

- 1) Press **[■]** **7**. Play stops.
- 2) (Wait 2 or more seconds)
Press **[■]** **7**. Recording stops.
 - You cannot stop recording with **[■]** **7** during timer recording. To stop timer recording, press **[⊖]**, **TIMER** **12**.

For your reference

- During simultaneous recording and play, you cannot edit with the direct navigator or play lists.
- If you start play while the unit is on standby for timer recording, recording starts when the time you set is reached.
- The unit returns to recording standby when you stop play while it is on standby for timer recording.
- The operation is shown on the unit's display (page 5).
- Sound is not output while fast-forwarding.
- While this function is activated, **TIME SLIP** indicator **41** lights up.

Checking the recording during recording (TIME SLIP)

RAM

You can play the programme being recorded to check that it is being recorded correctly. You can also check parts that were recorded previously.

Preparation

Switch [DVD, TV] **15** to "DVD".

While recording or timer recording

Press [TIME SLIP] **25**.

Play starts 30 seconds previous.

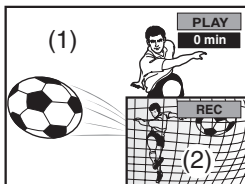

- (1) Play images (30 seconds before)
- (2) Current recording

To change the part being played

Press [▲, ▼] **10** to enter the time.

- Press [▲] **10** to increase or [▼] **10** to decrease in one-minute units. Press and hold [▲] **10** to increase or [▼] **10** to decrease in 10-minute units.

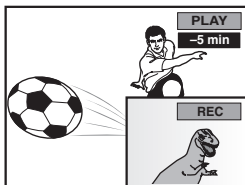

To show the play images in full

Press [TIME SLIP] **25**.

- Press [TIME SLIP] **25** to return to the picture-in-picture screen.

To stop play and recording

- 1) Press [■] **7**. Play stops.
- 2) (Wait 2 or more seconds)
Press [■] **7**. Recording stops.
 - You cannot stop recording with [■] **7** during timer recording. To stop timer recording, press [⊖, TIMER] **12**.

For your reference

- The sound for the images being played is heard during Time Slip.
- While this function is activated, TIME SLIP indicator **41** lights up.
- The image on the small screen may be distorted or flicker depending on the scene. However, this does not affect the image recorded.

Watching the television while recording

Preparation

Switch [DVD, TV] **15** to "TV".

- 1 Press [AV] **3** to change the input mode to "TV".
- 2 Press [▲, ▼, CH] **18** to change channels.
 - You can also select the channel with the numeric buttons **4**.

For your reference

- You can also do this if the unit is making a timer recording.
- The recording is unaffected.

Using the FUNCTIONS window

About the FUNCTIONS window

Most of the features and functions of this unit can also be controlled with icons. The examples show the FUNCTIONS window when a DVD-RAM is being used. Actual menus depend on the type of disc being used.

Disc display

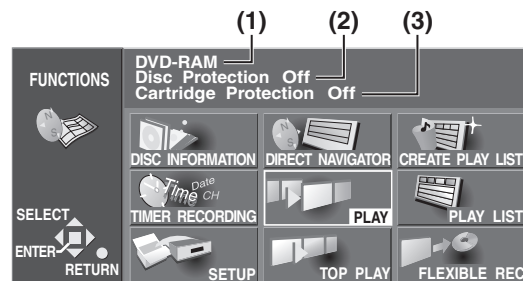

(1) Disc title

- The disc's title is displayed if one is recorded. You can enter titles with Enter Title in DISC INFORMATION (page 29).

(2) Disc protection

- "On" is displayed if you have used Disc Protection in DISC INFORMATION to protect the disc (page 30).

(3) Cartridge Protection

- "On" is displayed if the cartridge's write protect tab is switched to "PROTECT" (page 64).

Using the FUNCTIONS window

RAM DVD-R DVD-V CD VCD MP3

Preparation

Switch [DVD, TV] **15** to "DVD".

1 While stopped

Press [FUNCTIONS] **11** to show the FUNCTIONS window.

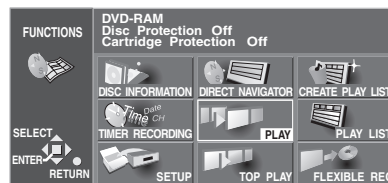

2 Use [▲, ▼, ◀, ▶] **10** to select an item.

- Refer to the relevant pages for details.

3 Press [ENTER] **10**.

- Your selection is entered and the FUNCTIONS window disappears. If the operation requires further selections, another screen appears.

To clear the FUNCTIONS window

Press [FUNCTIONS] **11** or [RETURN] **23**.

FUNCTIONS window icons**DISC INFORMATION**

Enter Title: **RAM** **DVD-R** (page 29)
 Disc Protection: **RAM** (page 30)
 Erase all programmes: **RAM** (page 31)
 Format: **RAM** (page 31)
 Finalize: **DVD-R** (page 32)

TIMER RECORDING

Checking the timer programming: **RAM** **DVD-R** (page 27)
 Registering programmes and making corrections:
RAM **DVD-R** (page 26)
 Cancelling timer recordings: **RAM** **DVD-R** (page 27)

SETUP

Settings for the unit and discs: **RAM** **DVD-R** **DVD-V** **CD** **VCD**
MP3 Settings depend on the type of disc (page 51)

DIRECT NAVIGATOR

Play: **RAM** **DVD-R** (page 33)
 Erase: **RAM** **DVD-R** (page 34)
 Enter Title: **RAM** **DVD-R** (page 34)
 Properties: **RAM** **DVD-R** (page 34)
 Protection: **RAM** (page 35)
 Partial Erase: **RAM** (page 36)
 Divide: **RAM** (page 36)

PLAY

Disc play: **RAM** **DVD-R** **DVD-V** **CD** **VCD**
MP3 (page 13)

RESUME PLAY

Start play from the point you stopped play:
RAM **DVD-R** **DVD-V** **CD** **VCD**
MP3 (page 14)

TOP PLAY

Start play from the oldest programme on the disc:
RAM **DVD-R** **DVD-V** **CD** **VCD**
MP3 (page 13)

CREATE PLAY LIST

Creating play lists: **RAM** (page 38)

PLAY LIST

Playing Play Lists: **RAM** (page 39)
 Play Scenes: **RAM** (page 39)
 Edit: **RAM** (pages 40 and 41)
 PL Copy: **RAM** (page 42)
 PL Erase: **RAM** (page 42)
 Enter Title: **RAM** (page 42)
 Properties: **RAM** (page 42)

FLEXIBLE REC

Flexible recording mode: **RAM** **DVD-R** (page 20)

TOP MENU MENU

Example
 Display a disc's menus: **DVD-V** (page 13)

Some items will not be shown unless you release disc protection with DISC INFORMATION—"Disc Protection" (page 30) or release cartridge protection with the write protect tab (page 64).

Timer recording

Using G-CODE number to make timer recording

RAM DVD-R

Remote control only

You can easily programme the unit to make a timer recording of a programme by entering the programme's G-CODE number, which can be found in the television sections of newspapers or in television guides. You can programme up to 16 programmes one month in advance. Programmes for everyday or every week are counted as one programme.

Preparation

- Switch [DVD, TV] **15** to "DVD".
- Ensure that this unit's clock is set correctly.
- Insert a disc for recording (make sure there is enough room for the programme you are going to record plus a little extra).

1 Press [G-Code] **2** button.

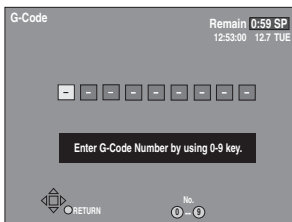

2 Press the numeric buttons **4** to enter the G-CODE number.

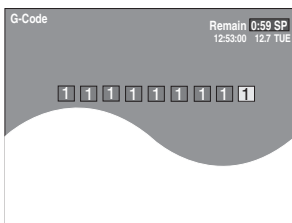

- If you enter the wrong digit, use [**Left Arrow**] **10** to move back and enter the correct digit.

3 Press [ENTER] **10**.

- The Timer Programme Correction screen which allows you to confirm the programme appears and make corrections if necessary.

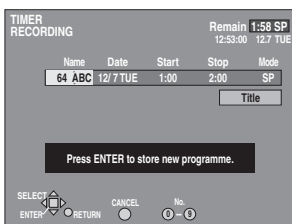

• Check the programme.

- To make corrections (page 25).
- To programme other recordings, repeat steps 1, 2 and 3.

4 If the programme is correct

Press [ENTER] **10**.

- The Timer Programme List screen appears.

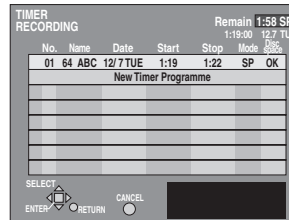

5 Press [RETURN] **23**.

■ To put the unit on recording standby

Press [**Down Arrow**, TIMER] **12**.

Ensure "**Down Arrow**" lights on the unit's display.

To change the programme



Timer Programme Correction screen (After step 3 on page 24)

- 1) Use [**◀**, **▶**] **10** to select the item you want to change.
- 2) Change the setting with [**▲**, **▼**] **10**.
 - You may use the numeric buttons **4** to enter "Name", "Date", "Start" and "Stop".

The items change as follows:

 - **Name** (Programme Position/TV Station Name)
 - **Date**
 Current date → the day before one month later →
 Daily (Sunday to Saturday) → Daily (Monday to Saturday) →
 Daily (Monday to Friday) → Weekly (Sundays) → ... →
 Weekly (Saturdays)
 - **Start (start time)/Stop (finish time)**
 The time increases or decreases in 30-minute increments if you hold the button.
 - **Mode (Recording mode)**
 XP → SP → LP → EP → FR (page 19)
 - **Title**
 Select "Title" and press [ENTER] **10**, then refer to page 29 for entering title.
 You can give DVD-RAM and DVD-R titles of up to 44 characters.
- 3) Press [ENTER] **10** when you have finished making changes. The Timer Programme List screen appears.

If "– –" appears under "Name" after entering a G-CODE number

Name stands for Programme Position/TV Station Name. Normally, the name of the TV station or the number of the programme position is displayed under "Name". However, if the TV station information was not automatically set during Auto Setup due to adverse reception conditions, the "– –" indication appears instead. In such a case, follow the operation steps below to correct it.

Use [▲**, **▼**] **10** repeatedly to select the programme position on which the TV programme to be recorded will be broadcast.**

After you have entered the information of a TV station, it remains stored in the unit's memory, and you do not need to enter it again in the future.

Notes

- The built-in clock employs 24-hour system.
- The actual time recorded may be longer than the programme itself when television programmes are recorded using G-CODE.
- "Invalid Entry" is displayed when you enter the wrong code. Reenter the code.
- "PROG FULL" is displayed in the unit's display if there are already 16 items programmed. Delete unnecessary items (page 27).
- The remaining time displayed is calculated based on the current recording mode.
- When recording more than one programme in a row, for DVD-RAM the first few seconds, and for DVD-R about the first 30 seconds of all programmes from the second one onwards will not be recorded.
- Recording is not possible unless you set "Disc Protection" in "DISC INFORMATION" to "Off". (page 30)
- You can not record to a disc if the write protect tab on a cartridge disc is set to protect. Release this before operation (page 64).
- Even if the unit is put in the timer recording standby mode or the timer recording is being performed, you can play a programme.

Manual programming

RAM DVD-R

Remote control only

You can set your own programming conditions (up to 16 programmes).

Preparation

- Switch [DVD, TV] **15** to "DVD".
- Ensure that this unit's clock is set correctly.
- Insert a disc for recording (make sure there is enough room for the programme you are going to record plus a little extra).

1 Press [PROG/CHECK] **13**.

- The Timer Programme List screen appears.

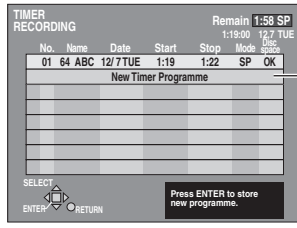

A line that is ready for programming is highlighted.

2 Press [ENTER] **10**.

- The Timer Programme Correction screen appears.

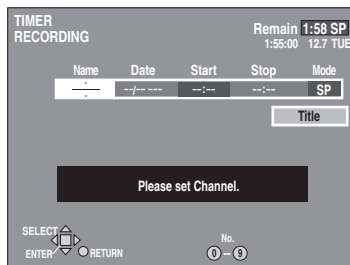

3 Use [▶] **10** to move through the items and change the items with [▲, ▼] **10**.

- The current settings are shown each time you press [▶] **10**.
- You may use the numeric buttons **4** to enter "Name", "Date", "Start" and "Stop".

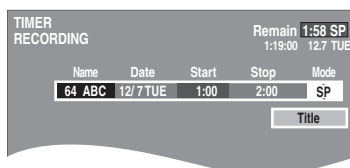

- **Name** (Programme Position/TV Station Name)
- **Date**
Current date → the day before one month later →
Daily (Sunday to Saturday) → Daily (Monday to Saturday) →
Daily (Monday to Friday) → Weekly (Sundays) → ... →
Weekly (Saturdays)
- **Start (start time)/Stop (finish time)**
The time increases or decreases in 30-minute increments if you hold the button.
- **Mode (Recording mode)**
XP → SP → LP → EP → FR (page 19)
- **Title**
Select "Title" and press [ENTER] **10**, then refer to page 29 for entering title.

4 Press [ENTER] **10** when you have finished making changes.

- To continue programming:
Repeat steps 2, 3 and 4.

5 Press [PROG/CHECK] **13** or [RETURN] **23**.

To put the unit on recording standby

Press [⏻, TIMER] **12**.

Ensure "⏻" lights on the unit's display.

To change the timer recording programme

- 1) While the Timer Programme List Screen is being shown, use [▲, ▼] **10** to select the programme you want to change, and press [ENTER] **10** to show the Timer Programme Correction screen.
 - You may also select programme by inputting a 2-digit number using the numeric buttons **4**.
 - Use [◀, ▶] **10** to move to the page preceding or following the one on display.
- 2) Move through the items with [▶] **10** and change the settings with [▲, ▼] **10** and press [ENTER] **10**.

Notes

- The built-in clock employs 24-hour system.
- The remaining time is not shown if you insert discs other than DVD-RAM or DVD-R.
- The remaining time displayed is calculated based on the current recording mode.
- If the disc is protected (pages 30 and 64), the unit switches to standby but does not go on standby for recording. Check the disc carefully.
- Recording is not possible unless you set "Disc Protection" in "DISC INFORMATION" to "Off". (page 30)
- You cannot record to a disc if the write protect tab on a cartridge disc is set to protect. Release this before operation (page 64).
- Even if the unit is put in the timer recording standby mode or the timer recording is being performed, you can play a programme.
- When recording more than one programme in a row, for DVD-RAM the first few seconds, and for DVD-R about the first 30 seconds of all programmes from the second one onwards will not be recorded.

To check programmes

RAM DVD-R

Press [PROG/CHECK] **13**.

The Timer Programme List screen appears.

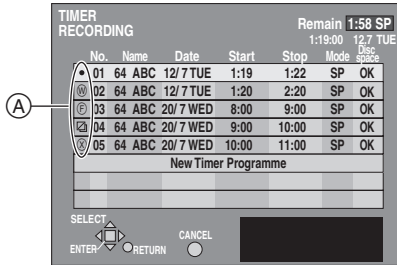

Icon explanations (A)

- This programme is currently recording.
- W The programme is overlap with another programme.
- F The disc was full or the maximum number of programmes or scenes was reached so the programme failed to record.
- ☒ The television programme was copy-guarded so the programme failed to record.
TV system of the programme is different from the setting in SETUP, so the programme failed to record.
- ✘ The programme did not complete recording because the disc is dirty or some other reason.

Disc space

- OK: Displayed if the recording can fit in the remaining space on the disc.
- (Date): For recordings made daily or weekly, the display will show until when recordings can be made based on the time remaining on the disc.
- !: Displayed if the disc is not inserted in the unit or is write-protected (pages 30 and 64) or there is not enough memory capacity left on the disc.

To change the programme

(page 26)

To exit from the Timer Programme List screen

Press [PROG/CHECK] **13** or [RETURN] **23**. (The television is shown.)

For your reference

- Programmes that failed to record are deleted from the list at 4 a.m. the day after tomorrow.

Starting and canceling programmes

RAM DVD-R

To put the unit on recording standby

Press [⏻, TIMER] **12**.

The unit turns off and “⏻” lights on the unit’s display.

Note

- The unit cannot go to timer recording standby if the disc is protected (pages 30 and 64) or full (“⏻” flashes). Check the disc carefully.

To release the unit from recording standby

If you want to record something else before the programme start time, for example:

Press [⏻, TIMER] **12**.

The unit turns on and “⏻” goes out.

- Be sure to press [⏻, TIMER] **12** before the programme start time to put the unit on recording standby. The programme only works if “⏻” is on.

To stop recording while a programme is working

Press [⏻, TIMER] **12**.

To clear a timer recording programme

RAM DVD-R

Press [CANCEL] **5** or [ERASE] **30** while the programme’s Timer Programme Correction screen is being shown.

(Alternatively, use [▲, ▼] **10** to select the programme in the Timer Programme List screen and press [CANCEL] **5** or [ERASE] **30**.)

- You can not delete programmes that are currently recording.

Recording from a video cassette player

When connected to the other equipment

RAM DVD-R

You can record audio and video being played on a video cassette player or a video camera connected to the input terminals.

Preparation

- Before connecting any cables, first make sure that the power for both units is off. Then after connecting any cable, turn on the both units.
- Connect the other equipment to this unit's input terminals (page 49).
- Switch [DVD, TV] **15** to "DVD".
- Insert a disc that can be recorded on.
- Select the recording mode, XP, SP, LP or EP (page 19).
- It is also possible to perform the flexible recording (FR) (page 20).

1 While stopped

Press [**^**, **v**, **CH**] **18** or [**INPUT SELECT**] **29** to select the input channel for the equipment you have connected.

- Select AV1, AV2 or AV3.

2 Start play on the other equipment.

3 Press [**●**, **REC**] **16** at the point you want to start recording.

■ To skip unwanted parts

Press [**II**] **8** to pause recording.

Press again to restart recording.

■ To stop recording

Press [**■**] **7**.

Note

- Stop play on the other equipment as well.

For your reference

- Poor video quality or colouring may indicate that the material you are recording has copy protection.
- Select the TV system (PAL/NTSC) of the programme you wish to record (page 53).
- Any software that has been so treated cannot be recorded using this unit.

RAM DVD-R

You can:

- Title discs with the DISC INFORMATION in the FUNCTIONS window.
- Title programmes with the Timer recording (page 25).
- Title programmes with the DIRECT NAVIGATOR (page 34).
- Title play lists with the PLAY LIST screen (page 42).

Preparation

- Switch [DVD, TV] **15** to "DVD".
- Insert a disc with something recorded on it.
- Select Titring "DISC INFORMATION", Titring "Timer recording", Titring "DIRECT NAVIGATOR", or Titring "PLAY LIST" screen.

1 After the titling screen appears

Use [**▲**, **▼**, **◀**, **▶**] **10** to select the character you want to enter and press [ENTER] **10**.

- You can enter the following characters.

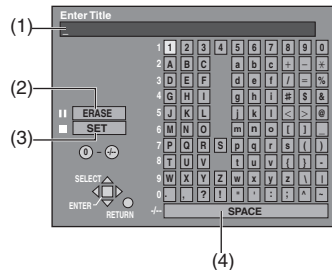

- (1) This window shows the text you have entered (Title field)
- (2) ERASE ([II] **8**)
- (3) SET ([I] **7**) (when you have finished entering text)
- (4) SPACE

To enter other characters

Repeat step 1.

2 Press [I] **7**. (You can also finish entering the title by using [**▲**, **▼**, **◀**, **▶**] **10** to select "SET" and pressing [ENTER] **10**.)

- The title is entered and the screen disappears.

To stop partway through

Press [RETURN] **23** (does not save any title information).

Using the numeric buttons **4** to enter characters

e.g., entering the letter "R"

- 1) Press [7] **4** to move to the 7th row.
 - 2) Press [7] **4** twice to highlight "R".
 - 3) Press [ENTER] **10**.
- You may enter a space by pressing [/-] **4** and then [ENTER] **10**.



To correct a character

- 1) Use [**▲**, **▼**, **◀**, **▶**] **10** to select the character you want to correct in the title field.
- 2) Press [II] **8**. (You can also erase characters by using [**▲**, **▼**, **◀**, **▶**] **10** to select "ERASE" and pressing [ENTER] **10**.)
- 3) Use [**▲**, **▼**, **◀**, **▶**] **10** to select the correct character and press [ENTER] **10**.

Notes

- You cannot enter titles if the programme is protected. Release the protection with the direct navigator (page 35).
- You cannot enter titles unless the "Disc Protection" in DISC INFORMATION is "Off" (page 30).
- You cannot enter titles if the disc is protected with the write protect tab (page 64).
- If you enter a long title, only part of it is shown in the programme list (page 33) and play list screen (page 37).

About DISC INFORMATION

RAM DVD-R

- You can give discs titles—Enter Title
- You can write-protect and write-enable DVD-RAM—Disc Protection
- You can erase all programmes and play lists on DVD-RAM—Erase all programmes
- You can format DVD-RAM—Format
- You can finalize DVD-R so they can be played on compatible DVD players—Finalize

Enter Title

RAM DVD-R

Each disc can be given a different title.

Preparation

- Switch [DVD, TV] **15** to "DVD".
- Insert a disc you have recorded on.

1 While stopped

Press [FUNCTIONS] **11**.

2 Use [**▲**, **▼**, **◀**, **▶**] **10** to select "DISC INFORMATION" and press [ENTER] **10**.



3 Use [**▲**, **▼**] **10** to select "Enter Title" and press [ENTER] **10**.

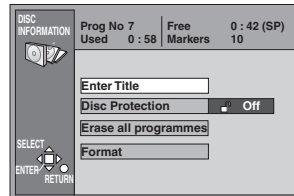

4 Enter the title.

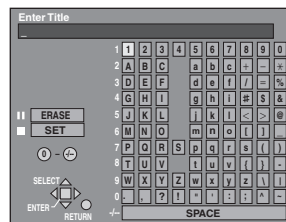

Notes

- You can give DVD-RAM titles of up to 64 characters and DVD-R titles of up to 40 characters.
- You cannot give DVD-R titles once they have been finalized.

Disc Protection

RAM

This allows you to protect discs from accidental erasure.

Preparation

- Switch [DVD, TV] **15** to "DVD".
- Insert the disc you want to protect.

- 1 While stopped
Press [FUNCTIONS] **11**.
- 2 Use [▲, ▼, ◀, ▶] **10** to select "DISC INFORMATION" and press [ENTER] **10**.



- 3 Use [▲, ▼] **10** to select "Disc Protection" and press [ENTER] **10**.

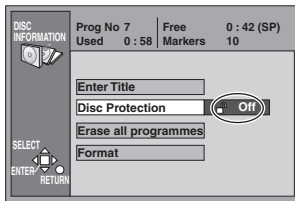

- 4 Use [◀] **10** to select "Yes" and press [ENTER] **10**.

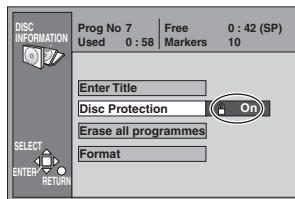
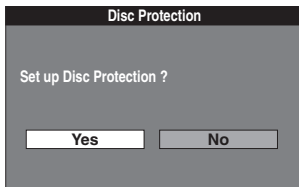

■ To stop partway through

Select "No" in step 4 and press [ENTER] **10**.
Or
Press [RETURN] **23**.

Releasing disc protection

RAM

This allows you to release disc protection.

Preparation

- Switch [DVD, TV] **15** to "DVD".
- Insert the disc you want to release protection.

- 1 While stopped
Press [FUNCTIONS] **11**.
- 2 Use [▲, ▼, ◀, ▶] **10** to select "DISC INFORMATION" and press [ENTER] **10**.



- 3 Use [▲, ▼] **10** to select "Disc Protection" and press [ENTER] **10**.



- 4 Use [◀] **10** to select "Yes" and press [ENTER] **10**.

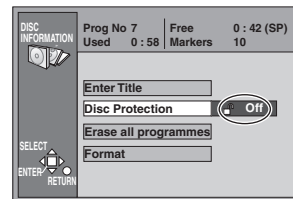
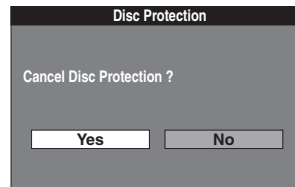

■ To stop partway through

Select "No" in step 4 and press [ENTER] **10**.
Or
Press [RETURN] **23**.

Erase all programmes

RAM

All programmes and play lists created from them will be erased irretrievably when you use this procedure.

Preparation

- Switch [DVD, TV] **15** to "DVD".
- Insert a disc you have recorded on.

- 1 While stopped
Press [FUNCTIONS] **11**.
- 2 Use [▲, ▼, ◀, ▶] **10** to select "DISC INFORMATION" and press [ENTER] **10**.



- 3 Use [▲, ▼] **10** to select "Erase all programmes" and press [ENTER] **10**.

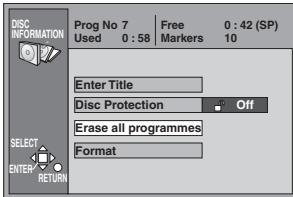

- 4 Use [◀] **10** to select "Yes" and press [ENTER] **10**.

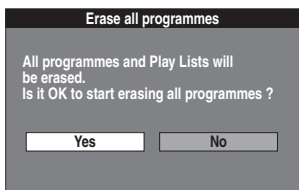

- 5 Use [◀] **10** to select "Start" and press [ENTER] **10**.



All programmes and play lists are erased.

To stop partway through

Select "No" in step 4 or "Cancel" in step 5 and press [ENTER] **10**.
Or
Press [RETURN] **23**.

Notes

- You cannot erase computer data.
- The disc title will also be erased.
- If protection is active on even one programme (page 35), you cannot erase all programmes.

For your reference

- Nothing will be erased if the disc is write-protected (pages 30 and 64).

Format

RAM

Some DVD-RAM are unformatted. You must format these discs before you can use them in this unit. Formatting also allows you to erase the entire contents of a disc.

Preparation

- Switch [DVD, TV] **15** to "DVD".
- Insert the disc you want to format.

- 1 While stopped
Press [FUNCTIONS] **11**.
- 2 Use [▲, ▼, ◀, ▶] **10** to select "DISC INFORMATION" and press [ENTER] **10**.



- 3 Use [▲, ▼] **10** to select "Format" and press [ENTER] **10**.

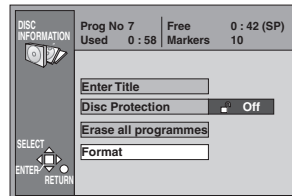

- 4 Use [◀] **10** to select "Yes" and press [ENTER] **10**.

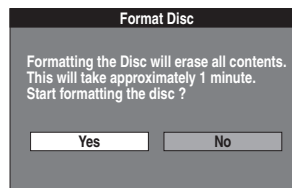

- 5 Use [◀] **10** to select "Start" and press [ENTER] **10**.

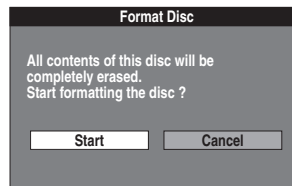

- Formatting starts.

The message "Formatting is complete" appears when formatting is finished.

All recordings are irretrievably erased when a disc is formatted. Check the disc carefully before formatting to ensure it doesn't contain any programmes you want to keep.

To stop formatting

Select "No" in step 4 or "Cancel" in step 5 and press [ENTER] **10**.
Or
Press [RETURN] **23**.

Notes

- Do not turn the unit off or disconnect the AC power supply cord while the message "Formatting the disc" is on the television.
This can render the disc unusable.
(This can take up to 70 minutes. You can cancel formatting if it takes more than 2 minutes by pressing [RETURN] **23**. The disc must be reformatted if you do this.)
- All data on the disc is erased when it is formatted, including recordings made with this unit. Data written to the disc by a computer is also erased.

For your reference

- The disc cannot be formatted if the write protect tab is switched to "PROTECT". Release the protection to continue (page 64).
- Formatting cannot be performed on DVD-R or CD-R/RW.
- The message "Unable to format" appears when you try to format discs this unit cannot use.
- If you have used the direct navigator to protect a programme (page 35), the message "Contents on the disc have been protected. Start formatting the disc?" appears in step 5. Select "Start" if you want to format the disc. The contents will be erased even if they have been protected.

Finalize—Creating DVD-Video

DVD-R

You can play DVD-R on compatible DVD players by finalizing them on this unit, effectively making them into DVD-Video.

The menus you create with this unit can also be used on the player.

Preparation

- Switch [DVD, TV] **15** to “DVD”.
- Insert the disc you want to finalize.

1 While stopped

Press [FUNCTIONS] **11**.

2 Use [▲, ▼, ◀, ▶] **10** to select “DISC INFORMATION” and press [ENTER] **10**.



3 Use [▲, ▼] **10** to select “Finalize” and press [ENTER] **10**.

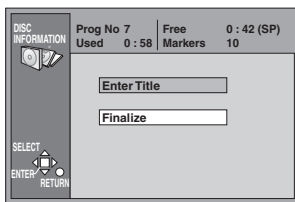

4 Use [◀] **10** to select “Yes” and press [ENTER] **10**.

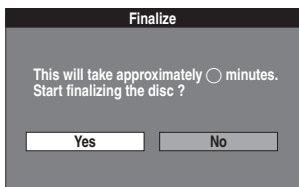

5 Use [◀] **10** to select “Start” and press [ENTER] **10**.

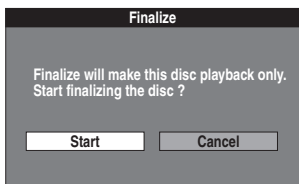

- Finalizing starts.
The message “Finalizing is finished” appears when finalizing is finished.

■ To stop finalizing

Select “No” in step 4 or “Cancel” in step 5 and press [ENTER]

10.

Or

Press [RETURN] **23**.

Notes

- Do not turn the unit off or disconnect the power supply cord while the message “Finalizing the Disc” is on the television. This can render the disc unusable.
- You can only finalize DVD-R that were recorded on this unit.
- You cannot record on DVD-R that have been finalized.
- Programmes longer than 5 minutes will be divided into about 5-minute chapters.
- The markers you entered (page 17) will be lost.
- Finalizing takes up to about 15 minutes.

Using the DIRECT NAVIGATOR

Selecting programmes to play

RAM DVD-R

A list of programmes is created as you record them. You can use this list to find the programmes you want to watch.

Preparations

- Switch [DVD, TV] **15** to "DVD".
- Insert a disc you have recorded on.

1 Press [DIRECT NAVIGATOR] **9**.

- The programme list appears.
- The images for the currently highlighted list are played in the background.

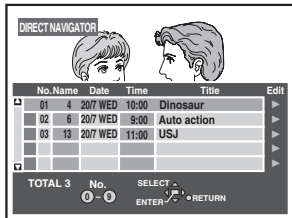

2 Use [**▲**, **▼**] **10** to select the programme you want to watch and press [ENTER] **10**.

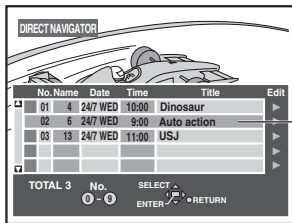

- Play of the images that were playing in the background continues.

To clear the programme list

Press [DIRECT NAVIGATOR] **9** or [RETURN] **23**.

For your reference

- The direct navigator works while stopped, playing or recording.
- You can also select programmes from the list in step 2 by entering a 2-digit number with the numeric buttons **4**.
If you enter a number larger than the total number of programmes, the last programme is selected.
- Titles are only displayed if you have given the programme a title.
- The unit's clock must be set correctly.

About the programme list

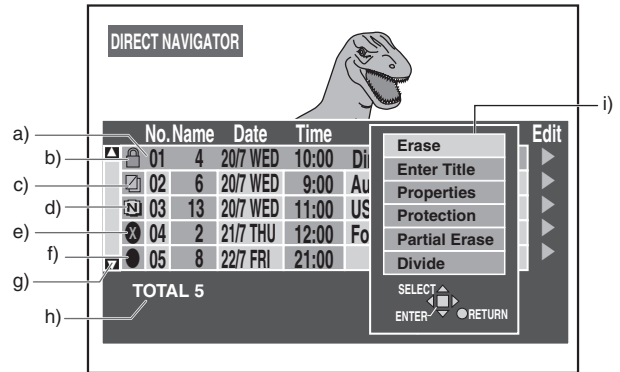

- Programme number, broadcast name, recording date, time recording started, programme title (if entered).**
 - Programme 1 is selected in the example.
- Write-protected:**
 - Displayed when you have protected the programme. Programme 1 has been protected in the example.
- Copy-protected/Different TV system (PAL or NTSC):**
 - Displayed when you have recorded a programme that has copy protection, from broadcast.
 - Displayed when the programme failed to record so that the TV system of the programme is different from the setting in SETUP.
- NTSC:** / **PAL:**
 - Displayed when you recorded using a different encoding system from that of the TV system currently selected on the unit.
- Unable to play:**
 - Displayed if you cannot play the programme.
- Currently recording:**
 - Displayed when the programme is being recorded.
- Scroll bar**
 - If there are more than 6 programmes, you can move down the list by using [**▲**, **▼**] **10** and this bar shows your approximate position in the list.
- Total number of programmes**
 - Shows the total number of programmes.
- Sub menu**
 - Displayed when you use [**▶**] **10**. (You can see this during simultaneous recording and play but you are unable to perform operations.)
 - Erase a programme (page 34).
 - Enter or edit a title (page 34).
 - Check a programme's contents (page 34).
 - Write-protect a programme (page 35).
 - Erase part of a programme (page 36).
 - Divide a selected programme into two (page 36).

For your reference

- The list can show up to 99 programmes that you have recorded.
- When using DVD-R, "Protection", "Partial Erase" and "Divide" are not displayed in the sub menu.
- The contents of the list are recorded on the disc.
- **RAM**
When the disc is protected (pages 30 and 64), you can only access "Properties". Release the protection to access other items.

Erasing programmes

RAM DVD-R

The programme is erased completely when you use this procedure and cannot be retrieved. Check the programme carefully before erasing it to ensure it isn't one you want to keep.

Preparations

- Switch [DVD, TV] **15** to "DVD".
- Insert a disc you have recorded on.

- 1 Press [DIRECT NAVIGATOR] **9**.
- 2 Use [**▲**, **▼**] **10** to select the desired programme.
- 3 Use [**▶**] **10** so the submenu appears.

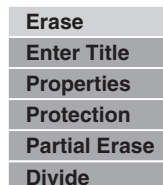

- 4 Use [**▲**, **▼**] **10** to select "Erase" and press [ENTER] **10**.
- 5 Use [**◀**] **10** to select "Erase".

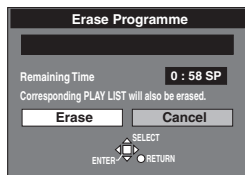

- 6 Press [ENTER] **10**.

■ To stop partway through

Select "Cancel" in step 5 and press [ENTER] **10**.

Or

Press [RETURN] **23**.

For your reference

- The disc's available recording time may not increase after erasing short programmes.
- Computer data is not erased.
- The available recording time on DVD-R does not increase when you erase programmes.

Entering and editing programme titles

RAM DVD-R

Preparations

- Switch [DVD, TV] **15** to "DVD".
- Insert a disc you have recorded on.

After performing steps 1 to 3 of "Erasing programmes", perform the following steps:

- 4 Use [**▲**, **▼**] **10** to select "Enter Title" and press [ENTER] **10**.
- 5 Enter or edit the title.

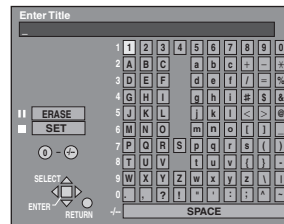

- "Entering titles" (page 29)

For your reference

- You can give DVD-RAM titles of up to 64 characters - a maximum of 44 characters is possible when inputting a title from the timer recording menu.
- You can give DVD-R titles of up to 44 characters.
- The full title is shown in the "Properties" screen, but if you enter a long title, only part of it is shown in the programme list.

Checking programme contents

RAM DVD-R

You can check the contents of a selected programme.

Preparations

- Switch [DVD, TV] **15** to "DVD".
- Insert a disc you have recorded on.

After performing steps 1 to 3 of "Erasing programmes", perform the following steps:

- 4 Use [**▲**, **▼**] **10** to select "Properties" and press [ENTER] **10**.
 - The contents of the programme are shown.

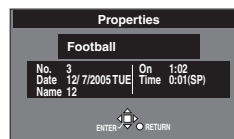

■ To return to the previous screen

Press [RETURN] **23**.

Protecting programmes

RAM

You can prevent accidental erasure of programmes by write-protecting them.

Preparations

- Switch [DVD, TV] **15** to “DVD”.
- Insert a disc you have recorded on.

After performing steps 1 to 3 of “Erasing programmes”, perform the following steps:

- 4 Use [**▲**, **▼**] **10** to select “Protection” and press [ENTER] **10**.
- 5 Use [**◀**] **10** to select “Yes” and press [ENTER] **10**.

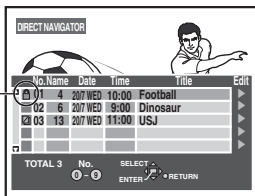
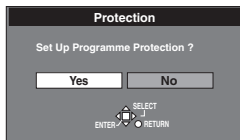

The padlock mark appears.

■ To stop partway through

Select “No” in step 5 and press [ENTER] **10**.

Or

Press [RETURN] **23**.

For your reference

Programmes will be erased even if they are protected if you format the disc with DISC INFORMATION (page 31).

Releasing programme protection

RAM

Preparations

- Switch [DVD, TV] **15** to “DVD”.
- Insert a disc you have recorded on.

After performing steps 1 to 3 of “Erasing programmes”, perform the following steps:

- 4 Use [**▲**, **▼**] **10** to select “Protection” and press [ENTER] **10**.
- 5 Use [**◀**] **10** to select “Yes” and press [ENTER] **10**.

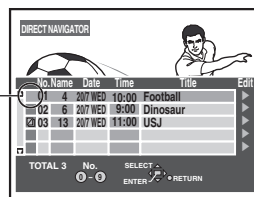
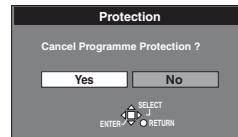

The padlock mark disappears.

■ To stop partway through

Select “No” in step 5 and press [ENTER] **10**.

Or

Press [RETURN] **23**.

Erasing parts of a programme

RAM

The specified parts of the programme are erased completely when you use this procedure and cannot be retrieved. Check the programme carefully to ensure it isn't one you want to keep.

Preparations

- Switch [DVD, TV] **15** to "DVD".
- Insert a disc you have recorded on.

After performing steps 1 to 3 of "Erasing programmes", perform the following steps:

- 4 Use [**▲**, **▼**] **10** to select "Partial Erase" and press [ENTER] **10**.
- 5 Use search functions such as fast-forward and slow-motion to find the start point of the part you want to erase and press [ENTER] **10**.

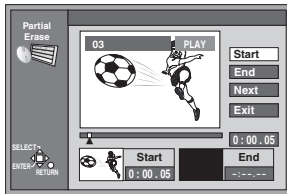

- 6 Use search functions such as fast-forward and slow-motion to find the end point of the part you want to erase and press [ENTER] **10**.

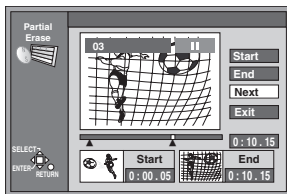

- 7 Use [**▲**, **▼**] **10** to select "Exit" and press [ENTER] **10**.
- 8 Use [**◀**] **10** to select "Erase" and press [ENTER] **10**.
 - Play lists created with the erased part are also erased.

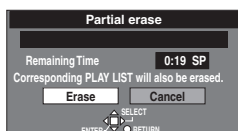

■ To stop partway through

Select "Cancel" in step 8 and press [ENTER] **10**.

Or

Press [RETURN] **23**.

■ To erase another part of the same programme

Select "Next" in step 7 and perform step 8, then repeat steps 5-8.

For your reference

- Use search and slow-motion to find the points.
- You cannot specify an end point before a start point or a start point after an end point.
- You may not be able to specify start and end points within 3 seconds of each other.
- You cannot specify start and end points if the picture recorded is still.
- The unit pauses play when the end of the programme is reached during this procedure.
- The disc's available recording time may not increase after erasing short parts of programmes.
- Play lists created with the erased part are also erased.

Dividing programmes

RAM

You can divide a selected programme into two.

You must be sure you wish to divide a programme because once a programme has been divided it cannot be returned to its original form.

Preparations

- Switch [DVD, TV] **15** to "DVD".
- Insert a disc you have recorded on.

After performing steps 1 to 3 of "Erasing programmes", perform the following steps:

- 4 Use [**▲**, **▼**] **10** to select "Divide" and press [ENTER] **10**.
- 5 Use search functions such as fast-forward and slow-motion to find the point you want to divide and press [ENTER] **10**.

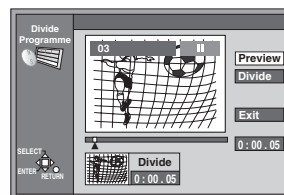

- 6 Use [**▲**, **▼**] **10** to select "Exit" and press [ENTER] **10**.
- 7 Use [**◀**] **10** to select "Divide" and press [ENTER] **10**.

- The programme is divided at the point.

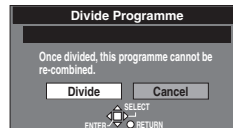

■ To stop partway through

Select "Cancel" in step 7 and press [ENTER] **10**.

Or

Press [RETURN] **23**.

■ To change the point to divide

Select "Divide" in step 6, then repeat steps 5-7.

■ To check the division point

By selecting "Preview" in step 6 and pressing [ENTER] **10**, play will begin from a point 10 seconds prior to the division point. You may wish to make sure that the division point is at an appropriate location.

Notes

- The divided programmes retain the title of the original programme.
- A minute portion of the recording directly preceding the division point may be lost.

For your reference

- Use search and slow-motion to find the points.
- It is not possible to carry out "Divide" in the following cases:
 - When the resulting part(s) are extremely short.
 - When the total number of programme is more than 99.

Using PLAY LIST to edit programmes

Displaying PLAY LIST

RAM

Preparations

- Switch [DVD, TV] **15** to "DVD".
- Insert a disc you have recorded on.

Press [PLAY LIST] **22**.

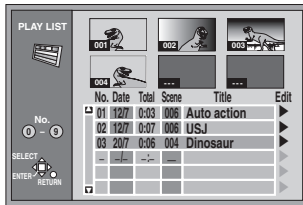

The play list screen appears. Scenes are not displayed if you have not yet created a play list with the disc.

To clear the PLAY LIST screen

Press [PLAY LIST] **22** or [RETURN] **23**.

The screen returns to the state it was in before you called up the play list.

What you can do with the PLAY LIST screen

- Creating PLAY LIST (page 38)
- Playing PLAY LIST (page 39)
- Select a scene to play (page 39)
- Add, move, re-edit and erase scenes (pages 40 and 41)
- Copying PLAY LIST (page 42)
- Erasing a PLAY LIST (page 42)
- Give PLAY LIST titles (page 42)
- Checking PLAY LIST's contents (page 42)

Play Scenes
Edit
PL Copy
PL Erase
Enter Title
Properties

For your reference

- When the disc is protected (pages 30 and 64), you can only access "Play Scenes" and "Properties". Release the protection to access other items.

About the PLAY LIST Scene screen

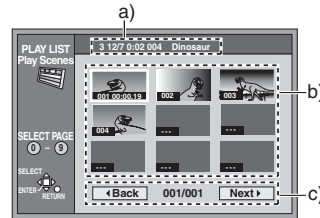

a) Play list information

This shows the play list number, date of creation (date/month), total play time, and the number of scenes it contains and title (if entered).

b) Scenes

9 scenes can be shown on a page.

c) Turning pages

If there are more than 9 scenes, use [▲, ▼, ◀, ▶] **10** to select "◀ Back" or "Next ▶" and press [ENTER] **10** to move to the previous page or next page. You can also enter the 3 digits with the numeric buttons **4**.

Creating PLAY LIST

RAM

You can specify start and end points to create a scene, then specify the order in which these scenes are played. These scenes are not recorded separately so this doesn't use up much of the disc's capacity.

Preparations

- Switch [DVD, TV] **15** to "DVD".
- Insert a disc you have recorded on.

1 While stopped

Press [FUNCTIONS] **11**.

2 Use [▲, ▼, ◀, ▶] **10** to select "CREATE PLAY LIST" and press [ENTER] **10**.



3 Use search functions such as fast-forward and slow-motion to find the start point of the scene and press [ENTER] **10**.

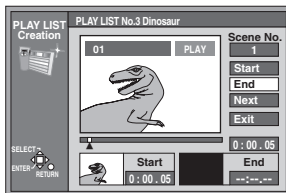

4 Use search functions such as fast-forward and slow-motion to find the end point of the scene and press [ENTER] **10**.

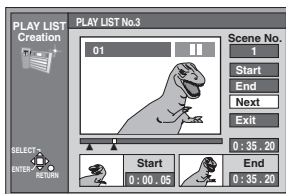

5 Use [▲, ▼] **10** to select "Exit" and press [ENTER] **10**.

■ To stop partway through

Press [RETURN] **23**.

■ To clear the PLAY LIST screen

Press [PLAY LIST] **22** or [RETURN] **23**.

The screen returns to the state it was in before you called up the play list.

■ To specify another scene

Select "Next" after step 4 and press [ENTER] **10**, then repeat steps 3 and 4.

For your reference

- You can fast-forward, rewind, pause and slow-motion while playing scenes just as you can during normal play.
- One disc can have a maximum of 99 play lists and 999 scenes. These numbers may be reduced under some conditions.
- You cannot specify an end point before a start point or a start point after an end point.
- If you specify an end point but not a start point, the unit determines the beginning of the programme as the start point. Similarly, if you specify a start point but not an end point, the unit determines the end of the programme as the end point.
- You may not be able to specify start and end points if the material is still pictures recorded on other equipment.
- The unit pauses play when the end of the last programme on the disc is reached during this procedure.
- You can also display the CREATE PLAY LIST screen by selecting "—" at the bottom of the play list.

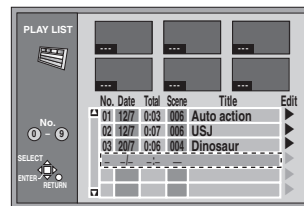

Playing PLAY LIST

RAM

Preparations

- Switch [DVD, TV] **15** to "DVD".
- Insert a disc you created play lists on.

- 1 Press [PLAY LIST] **22**.
- 2 Use [**▲**, **▼**] **10** to select the play list you want to play and press [ENTER] **10**.
 - The play list you select is played.
 - You can display the play lists after the sixth one by moving [**▼**] **10**.

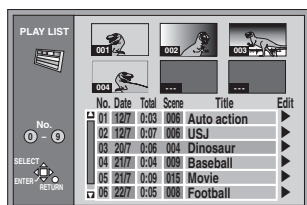

To stop PLAY LIST play

Press [■] **7**.

The play list appears.

For your reference

You can also select play lists from the list in step 2 by entering a 2-digit number with the numeric buttons **4**.

If you enter a number larger than the total number of play lists, the last play list is selected.

Playing Scenes

RAM

Preparations

- Switch [DVD, TV] **15** to "DVD".
- Insert a disc you created play lists on.

- 1 Press [PLAY LIST] **22**.
- 2 Use [**▲**, **▼**] **10** to select the play list that contains the scene you want to play and use [**▶**] **10**.

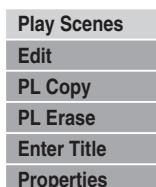

- 3 Use [**▲**, **▼**] **10** to select "Play Scenes" and press [ENTER] **10**.



- 4 Use [**▲**, **▼**, **◀**, **▶**] **10** to select the scene you want to play and press [ENTER] **10**.
 - The scene you select is played.

To stop scene play

Press [■] **7**.

The scene list appears.

To show scene 10 and later

In step 4, use [**▲**, **▼**, **◀**, **▶**] **10** to select "Next ▶" and press [ENTER] **10**.

For your reference

You can also select a page of scenes in step 4 by entering a 3-digit number with the numeric buttons **4**.

To erase a PLAY LIST or a PLAY LIST Scene during play

- 1 During play a play list or a play list scene Press [ERASE] **30**.
 - A confirmation message will be displayed.
- 2 Press [**◀**] **10** to select "Yes" and press [ENTER] **10**.
 - Select "No" and press [ENTER] **10**, or press [RETURN] **23** to cancel.

Adding Scenes to a PLAY LIST

RAM

Preparations

- Switch [DVD, TV] **15** to "DVD".
- Insert a disc you created play lists on.

- 1 Press [PLAY LIST] **22**.
- 2 Use [**▲**, **▼**] **10** to select the desired play list and press [**▶**] **10**.

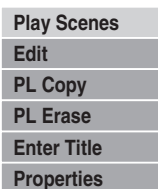

- 3 Use [**▲**, **▼**] **10** to select "Edit" and press [ENTER] **10**.

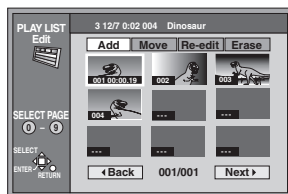

- 4 Use [**◀**, **▶**] **10** to select "Add" and press [ENTER] **10**.
- 5 Use [**▲**, **▼**, **◀**, **▶**] **10** to select the scene after the position you want to add the scene and press [ENTER] **10**.
- 6 Use search functions such as fast-forward and slow-motion to find the start point of the scene and press [ENTER] **10**.



- 7 Use search functions such as fast-forward and slow-motion to find the end point of the scene and press [ENTER] **10**.
- 8 Use [**▲**, **▼**] **10** to select "Exit" and press [ENTER] **10**.
 - The screen from step 4 reappears.

■ To return to the previous screen

Press [RETURN] **23**.

■ To add other scene

- 1) Use [**▲**, **▼**] **10** after step 7 to select "Next" and press [ENTER] **10**.
- 2) Repeat steps 6 and 7.

For your reference

You can fast-forward, rewind, pause and slow-motion while playing scenes just as you can during normal play.

Moving a Scene

RAM

Preparations

- Switch [DVD, TV] **15** to "DVD".
- Insert a disc you created play lists on.

After performing steps 1 to 3 of "Adding Scenes to a PLAY LIST", perform the following steps:

- 4 Use [**◀**, **▶**] **10** to select "Move" and press [ENTER] **10**.

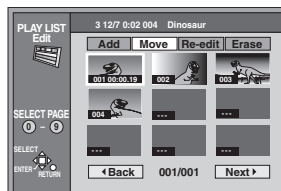

- 5 Use [**▲**, **▼**, **◀**, **▶**] **10** to select the scene you want to move and press [ENTER] **10**.

- 6 Use [**▲**, **▼**, **◀**, **▶**] **10** to select the scene currently in the position to which you want to move the scene and press [ENTER] **10**.

- The scene you selected in step 5 moves to the position in front of the scene selected.

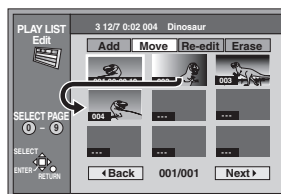

■ To move another scene

Repeat steps 5 and 6.

To re-edit a PLAY LIST Scene

RAM

Preparations

- Switch [DVD, TV] **15** to "DVD".
- Insert a disc you created play lists on.

After performing steps 1 to 3 of "Adding Scenes to a PLAY LIST", perform the following steps:

- 4 Use [**◀**, **▶**] **10** to select "Re-edit" and press [ENTER] **10**.

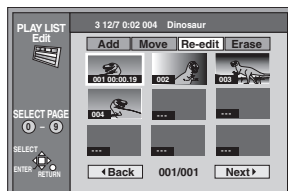

- 5 Use [**▲**, **▼**, **◀**, **▶**] **10** to select the scene you want to re-edit and press [ENTER] **10**.
- 6 Use search function such as fast-forward and slow-motion to find the start point of the scene and press [ENTER] **10**.
- 7 Use search functions such as fast-forward and slow-motion to find the end point of the scene and press [ENTER] **10**.

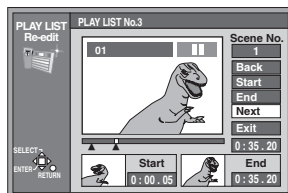

- 8 Use [**▲**, **▼**] **10** to select "Exit" and press [ENTER] **10**.

To re-edit another scene

- (1) Use [**▲**, **▼**] **10** after step 7 to select "Next" or "Back" and press [ENTER] **10** until you find the scene you want to re-edit.
- (2) Repeat steps 5-7 to continue re-editing other scenes.

Note

- You cannot specify an end point before a start point or a start point after an end point.

For your reference

- You can fast-forward, rewind, pause and slow-motion while playing scenes just as you can during normal play.

Erasing a Scene from a PLAY LIST

RAM

Preparations

- Switch [DVD, TV] **15** to "DVD".
- Insert a disc you created play lists on.

After performing steps 1 to 3 of "Adding Scenes to a PLAY LIST", perform the following steps:

- 4 Use [**◀**, **▶**] **10** to select "Erase" and press [ENTER] **10**.

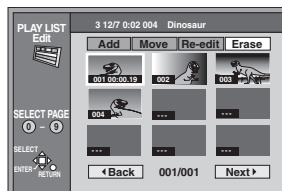

- 5 Use [**▲**, **▼**, **◀**, **▶**] **10** to select the scene you want to erase and press [ENTER] **10**.
- 6 Use [**◀**] **10** to select "Yes" and press [ENTER] **10**.

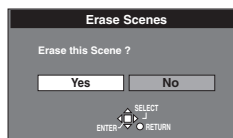

The selected scene is erased from the play list.

To erase other scene

Repeat steps 5 and 6.

To stop partway

Select "No" in step 6 and press [ENTER] **10**.

Or

Press [RETURN] **23**.

For your reference

The play list itself is erased if you erase all the scenes in it.

Copying PLAY LIST

RAM

Preparations

- Switch [DVD, TV] **15** to "DVD".
- Insert a disc you created play lists on.

After performing steps 1 to 2 of "Adding Scenes to a PLAY LIST", perform the following steps:

- 3 Use [**▲**, **▼**] **10** to select "PL Copy" and press [ENTER] **10**.
- 4 Use [**◀**] **10** to select "Yes" and press [ENTER] **10**.



The copied play list appears at the bottom of the list.

■ To stop partway

Select "No" in step 4 and press [ENTER] **10**.

Or

Press [RETURN] **23**.

Erasing a PLAY LIST

RAM

Preparations

- Switch [DVD, TV] **15** to "DVD".
- Insert a disc you created play lists on.

After performing steps 1 to 2 of "Adding Scenes to a PLAY LIST", perform the following steps:

- 3 Use [**▲**, **▼**] **10** to select "PL Erase" and press [ENTER] **10**.
- 4 Use [**◀**] **10** to select "Yes" and press [ENTER] **10**.



The play list is erased.

■ To stop partway

Select "No" in step 4 and press [ENTER] **10**.

Or

Press [RETURN] **23**.

Titling PLAY LIST

RAM

Preparations

- Switch [DVD, TV] **15** to "DVD".
- Insert a disc you created play lists on.

After performing steps 1 to 2 of "Adding Scenes to a PLAY LIST", perform the following steps:

- 3 Use [**▲**, **▼**] **10** to select "Enter Title" and press [ENTER] **10**.

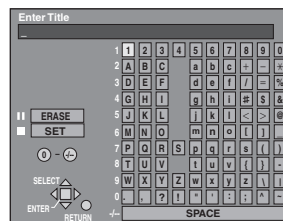

- 4 Enter the title.

- "Entering titles" (page 29)

For your reference

You can give play lists on DVD-RAM titles of up to 64 characters. The full title is shown in the "Properties" screen, but if you enter a long title, only part of it is shown in the play list screen.

Checking PLAY LIST's contents

RAM

Preparations

- Switch [DVD, TV] **15** to "DVD".
- Insert a disc you created play lists on.

After performing steps 1 to 2 of "Adding Scenes to a PLAY LIST", perform the following steps:

- 3 Use [**▲**, **▼**] **10** to select "Properties" and press [ENTER] **10**.



Using DISPLAY menus

RAM DVD-R DVD-V CD VCD MP3

Remote control only

DISPLAY menus contain information about the disc or unit. These menus allow you to perform operations by changing this information.

Common procedures

Preparation

Switch [DVD, TV] **15** to "DVD".

1 Press [DISPLAY] **34**.

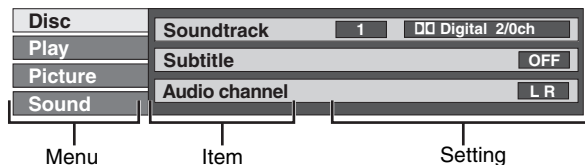

2 Use [▲, ▼] **10** to select the menu and press

[▶] **10**.

3 Use [▲, ▼] **10** to select the item and press

[▶] **10**.

4 Use [▲, ▼] **10** to select the setting.

- Some options require different operations. Follow the on-screen instructions and the instructions described later.

To return to the previous screen

Press [RETURN] **23**.

When you are finished

Press [DISPLAY] **34**.

For your reference

- The screens depend on the disc contents.
- Depending on the condition of the unit (playing, stopped, etc.) and the type of software you are playing, there are some items that you cannot select or change.

Disc menu

RAM DVD-R DVD-V VCD



Soundtrack

Soundtrack language DVD-V

(See [A] Soundtrack/Subtitle language.)

Change the number to select a soundtrack.

Audio attribute RAM DVD-R DVD-V

(See [B] Audio attributes.)

Karaoke vocals, on and off (Karaoke DVD-V only)

Solo: ON ↔ OFF

Duet: OFF ↔ V1 + V2 ↔ V1 ↔ V2

Subtitle

Subtitle language DVD-V

(See [A] Soundtrack/Subtitle language.)

Change the number to select a subtitle language.

Subtitles on/off RAM DVD-R DVD-V

Turn the subtitles on or off.

Angle DVD-V

Change the number to select an angle.

Audio channel RAM VCD

Select the audio channel. (page 16)

PBC VCD

Playback control on/off

Indicates whether menu play (playback control) is on or off.

[A] Soundtrack/Subtitle language

ENG: English	SVE: Swedish	CHI: Chinese
FRA: French	NOR: Norwegian	KOR: Korean
DEU: German	DAN: Danish	MAL: Malay
ITA: Italian	POR: Portuguese	VIE: Vietnamese
ESP: Spanish	RUS: Russian	THA: Thai
NLD: Dutch	JPN: Japanese	*: Others

[B] Audio attributes

D Digital/DTS/MPEG: Signal type

k (kHz): Sampling frequency

b (bit): Number of bits

ch (channel): Number of channels

For your reference

- You can only select subtitles, soundtracks and angles if they are recorded on the disc.
- Some discs allow changes to soundtracks, subtitles and angles only by using the disc's menus.
- If the subtitles overlap closed captions recorded on discs, turn the subtitles off.

Repeat play

RAM DVD-R DVD-V CD VCD MP3

During play

Use [▲, ▼] 10.



The display changes as illustrated.

RAM DVD-R

PRG (PROGRAMME) ↔ All ↔ OFF

DVD-V

Chapter ↔ Title ↔ OFF

CD VCD

Track ↔ All ↔ OFF

MP3

Track ↔ Group ↔ OFF

While playing a play list

RAM

PL (PLAY LIST) ↔ OFF

If the Video CD has playback control

- 1) While stopped (the screen saver is on the television), press the numeric buttons 4 to select a track.
- 2) Do the above operation.



Notes

- Repeat play may not work as desired with some discs.
- Repeat play does not work if the disc's elapsed play time is not shown on the unit's display.
- You cannot use repeat play to repeat an entire DVD-Video, MP3 discs or all the play lists on a DVD-RAM.
- [ERASE] 30 does not work while in repeat play mode.

Child Lock

The Child Lock deactivates all buttons on the unit and remote control. Use it to prevent other people from operating the unit.

Remote control only

To activate the Child Lock

Hold down [ENTER] **10** and [RETURN] **23** simultaneously until "X HOLD" appears on the unit's display.

- If you press a button while the Child Lock is on, "X HOLD" appears on the unit's display and operation is impossible.

To cancel the Child Lock

Hold down [ENTER] **10** and [RETURN] **23** simultaneously until "X HOLD" disappears.

- If you cannot cancel the Child Lock, press [RETURN] **23** and then perform the operation.

Upgrading your system

First of all, please disconnect AC mains leads of all units which you are going to connect with before connecting and disconnecting cables.

Enjoying more powerful sound

Refer to the relevant pages for details.

Enjoying 5.1-channel surround sound with Dolby Digital and DTS 	Digital connection Connect to an amplifier with built-in decoders.	Page 47 [A]	SETUP—Sound • Set "PCM Down Conversion" to "On". • Set "Dolby Digital" and "DTS" to suit the equipment.	Page 54
			Change speaker settings on the amplifier.	—

To enjoy stereo or Dolby Pro Logic 	Analog connection Connect to an analog amplifier or system component.	Page 47 [B]	SETUP—Sound • Set "PCM Down Conversion" to "Off".	Page 54
	Digital connection Connect to a digital amplifier or system component.	Page 47 [A]	SETUP—Sound • Set "PCM Down Conversion" to "On". • Set "Dolby Digital" to "PCM". • Set "DTS" to "Off".	Page 54

Other uses

Record to digital recording equipment or cassette deck ([A] [B] page 47)

Record from an video cassette recorder (page 49)

Use connection [B] to enjoy discs recorded with a sampling frequency of 96 kHz. Sound will not be output if you use connection [A] and set "PCM Down Conversion" to "Off" due to copy protection. (Convert the signal to 48 kHz to enjoy this type of audio.)

For your reference

- The equipment connections described are examples.
- Before connection, turn off all equipment and read the appropriate operating instructions.

Note

- You can enjoy Dolby Digital in stereo with this unit alone. (This unit does not have a DTS decoder.)

Connecting a digital amplifier or system component [A]

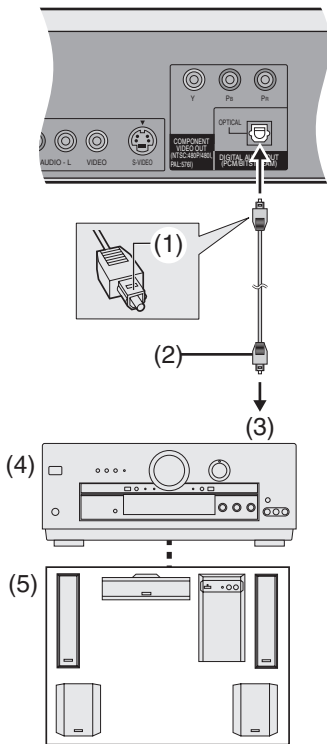

- (1) Insert fully, with this side facing up. (Do not bend when connecting.)
- (2) Optical digital audio cable (not supplied)
- (3) To optical digital input
- (4) Amplifier
or
system component (with or without decoders) (not supplied)
- (5) Speakers (not supplied)
 - Example: 6 speakers

For your reference

- Change the settings in the “Sound” menus (page 52) to suit the digital equipment you have connected. If the equipment can decode Dolby Digital, set “Dolby Digital” to “Bitstream” (factory setting). If the equipment can decode DTS, set “DTS” to “Bitstream”.
- The DTS decoder must be compatible with the signals recorded on DVD.
- During Quick View (Play ×1.3), the Digital Audio Output will change to PCM Output.

You can record the digital signal directly onto digital recording equipment.

The signals on DVDs will be converted to 48 kHz/16 bit linear PCM.

When recording DVDs, ensure the following conditions are met.

- There is no copy guard recorded on the disc.
- The recording equipment can handle a sampling frequency of 48 kHz/16 bit.
- You cannot record MP3.

If you want to use the synchro recording feature on your digital recording equipment and you use connection [A] or [B] to record from CDs or video CDs, first pause at the point you want to record from, activate the synchro feature, then restart play on the unit.

Connecting an analog amplifier or system component [B]

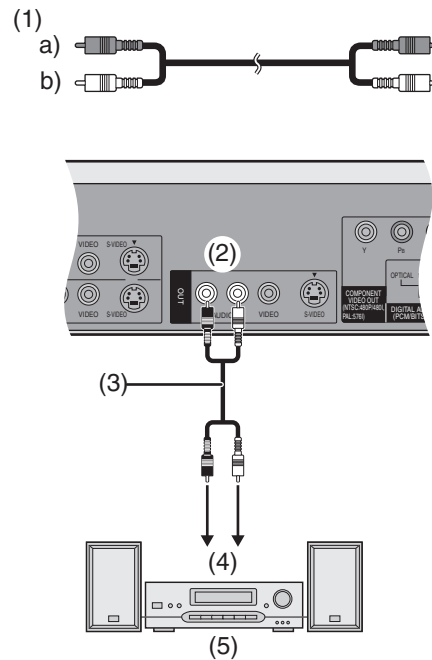

- (1) Audio cable
 - a) Red (R)
 - b) White (L)
- (2) To AUDIO OUT (L/R)
- (3) Audio cable (not supplied)
- (4) Audio input (L/R)
- (5) 2-channel analog amplifier or system component (not supplied)

■ To enjoy Dolby Pro Logic (page 61)

You will also need to connect center and surround speakers in addition to the front speakers to enjoy surround sound. Read the instructions for the equipment for connection details. Turn V.S.S. off. Dolby Pro Logic will not function correctly if V.S.S. is on.

Connecting a Television with Component video input terminals (For NTSC TV System only)

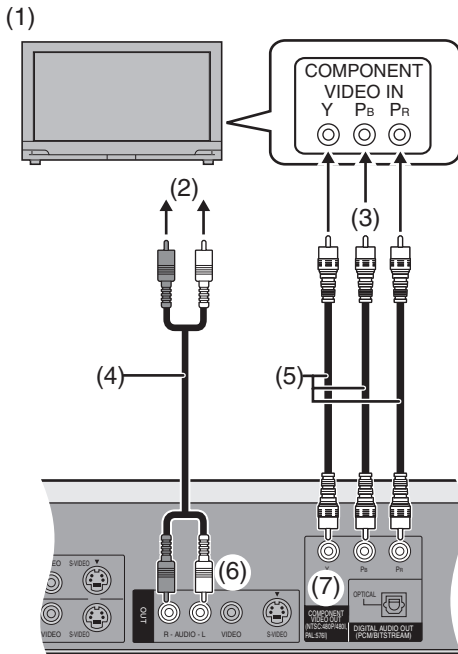

- (1) Television with Component video input terminals (not supplied)
- (2) Audio input (L/R)
- (3) Component video input (Y/P_B/P_R)
- (4) Audio cable (not supplied)
- (5) Video cable (not supplied)
- (6) To AUDIO OUT (L/R)
- (7) To COMPONENT VIDEO OUT (Y/P_B/P_R)

Preparation

- Switch [DVD, TV] **15** to "DVD".

- 1 Press [DVD, **1**] **1** to turn this unit on.
- 2 Press [FUNCTIONS] **11** to show the FUNCTIONS window.
- 3 Use [▲, ▼, ◀, ▶] **10** to select "SETUP" and press [ENTER] **10**.

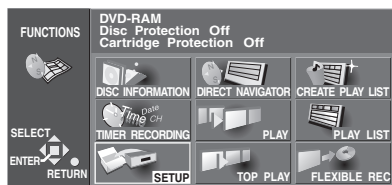

- 4 Use [▲, ▼] **10** to select the "Connection" and press [◀] or [▶] **10**.
- 5 Use [▲, ▼] **10** to select "TV System" and press [ENTER] **10**.

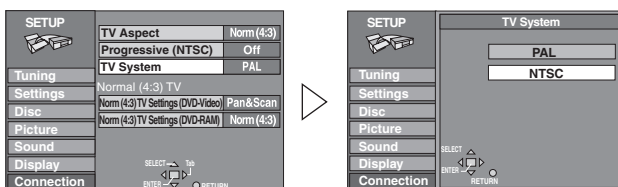

- 6 Use [▲, ▼] **10** to select "NTSC" and press [ENTER] **10**.

- 7 Use [▲, ▼] **10** to select "Progressive (NTSC)" and press [ENTER] **10**.

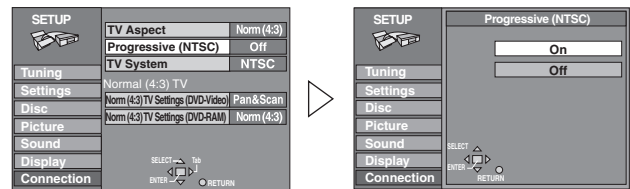

- 8 Use [▲, ▼] **10** to select "On" and press [ENTER] **10**.

■ To return to the previous screen
Press [RETURN] **23**.

■ To enjoy progressive video

Connect to the component video (480P) input terminals on a television compatible with this unit's copy guard system. (Video will not be displayed correctly if connected to an incompatible television.)

- All Panasonic televisions that have 480P input terminals are compatible. Consult the manufacturer if you have another brand of television.

■ COMPONENT VIDEO OUT terminal

These terminals can be used for either interlace or progressive output and provide a purer picture than the S-VIDEO OUT terminal.

Connection using these terminals outputs the color difference signals (P_B/P_R) and luminance signal (Y) separately in order to achieve high fidelity in reproducing colors.

- The description of the component video input terminals depends on the television or monitor (e.g. Y/P_B/P_R, Y/B-Y/R-Y, Y/C_B/C_R). Connect to terminals of the same colour.

When making this connection, ensure you connect the audio cables to the corresponding audio input terminals on the television.

■ Regarding Progressive Television Picture

Progressive image aspect (height to width ratio) is set at a standard 16:9. DVD-Video which has been set at 16:9 will be displayed correctly. However, 4:3 video material will be stretched to the right and left when displayed.

To view the picture at the right aspect

- For televisions that allow the aspect of progressive images to be adjusted, use the function provided on the television and adjust as necessary.
- For televisions which do not allow the aspect of progressive images to be adjusted, please set "Progressive (NTSC)" to "Off" (page 53).

Notes

- If the unit is connected to the TV through VIDEO OUT or S-VIDEO OUT, output will be interlace only (even if you select progressive output).
- When progressive output is on, closed captions can not be displayed.

Connecting a video cassette recorder

When connecting to the AV2 input terminals on the front of the unit

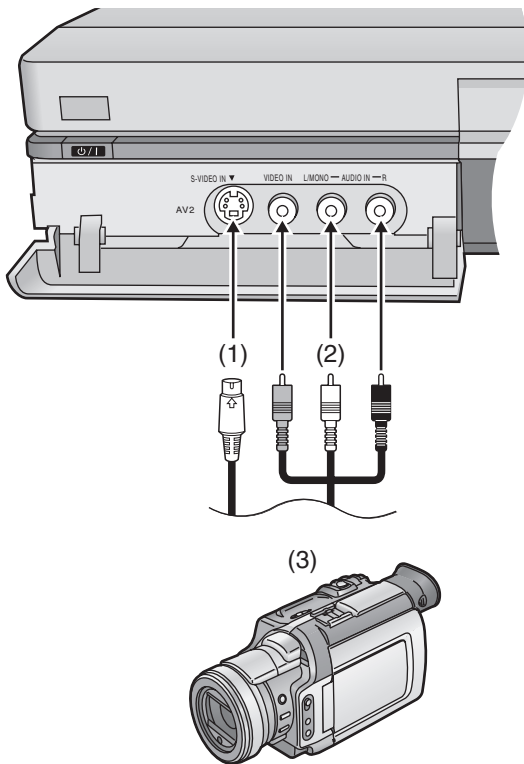

- (1) S video cable (not supplied)
- (2) Audio/Video cable (not supplied)
- (3) Other playback equipment
 - Connect to the video and audio output terminals.

Note

- If the audio output of the other equipment is monaural, connect to L/MONO. (Both left and right channels are recorded when connected through L/MONO.)

When connecting to the input terminals on the rear of the unit

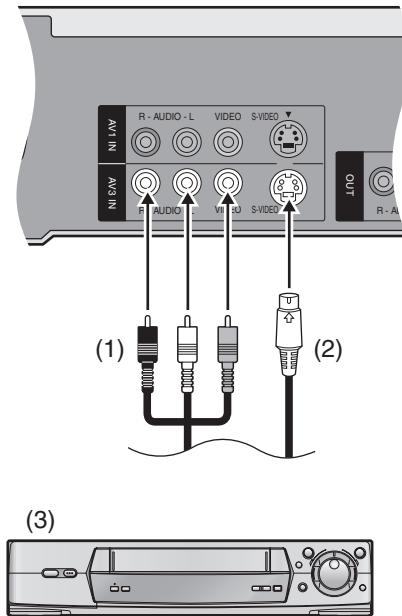

- (1) Audio/Video cable (not supplied)
- (2) S video cable (not supplied)
- (3) Other playback equipment
 - Connect to the video and audio output terminals.

Note

- If audio output of the other equipment is monaural, use a stereo-monaural conversion cable (not supplied).

Changing the unit's settings

Common procedures

Refer to the summary of settings table on page 51 and use the following procedure to change the settings if necessary.

Preparation

- Switch [DVD, TV] **15** to "DVD".

1 While stopped

Press [FUNCTIONS] **11** to show the FUNCTIONS window.

- 2 Use [▲, ▼, ◀, ▶] **10** to select "SETUP" and press [ENTER] **10**.

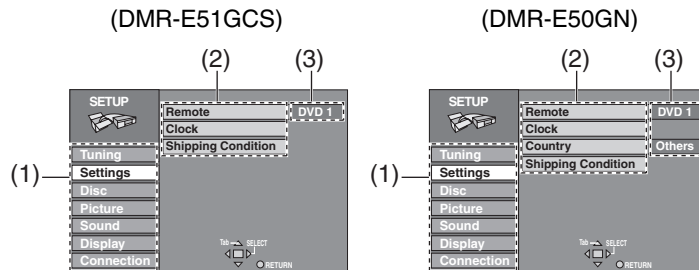

(1) Menus

The SETUP menu is made up of seven menus—Tuning, Settings, Disc, Picture, Sound, Display and Connection. Select the menu's tab to display the items.

(2) Items

A list of items in the menu you selected.

(3) Options

This shows the current settings. The options are shown when you select an item.

- 3 Use [▲, ▼] **10** to select the menu's tab and press [◀] or [▶] **10**.

- 4 Use [▲, ▼] **10** to select the item you want to change and press [ENTER] **10**.

- 5 Use [▲, ▼] **10** to select the option and press [ENTER] **10**.

- Some options require different operations. Follow the on-screen instructions and the instructions described.

■ To return to the previous screen

Press [RETURN] **23**. Even if you have changed an option, the change is not accepted unless you press [ENTER] **10**.

■ When you are finished

Press [FUNCTIONS] **11**.

For your reference

- The unit retains these settings in its memory until you change them, even if you turn it off.

Summary of settings

This description shows the initial settings for this unit. See page 50 for details on menu operation.

• Underlined items are the factory presets.

Tuning

Manual

Auto-Setup Restart

Settings

Remote

Change the remote control code so you can use other Panasonic DVD equipment at the same time.

[DVD_1] [DVD 2] [DVD 3]

Clock

Clock Setting (page 56)

You can adjust the clock.

Country (DMR-E50GN only)

[Australia] [New Zealand] [Others]

Shipping Condition

The all settings in the SETUP screen return to the factory settings. (except for the ratings level and the password)

[Yes] [No]

Disc DVD-V

Setting the language of disc menu, audio and subtitles for playing the DVD-Video.

- Some discs are designed to start in a certain language despite any changes you make here.
- If a language which is not recorded is selected, or if languages are already fixed in disc, the default language in the disc will play instead.

Soundtrack

Choose the preferred audio language.

[English] [French] [German] [Italian] [Spanish] [Original]
[Other ****]

Subtitle

Choose the preferred subtitle language.

[Automatic] [English] [French] [German] [Italian]
[Spanish] [Other ****]

Menus

Choose the preferred language for disc menus.

[English] [French] [German] [Italian] [Spanish]
[Other ****]

Original

The original language of each disc will be selected.

Other ****

This is language code setting.

Input a code number with the numeric buttons **4**.

(See below language code list)

Automatic

If the language selected for "Soundtrack" is not available, subtitles of that language will automatically appear if available on that disc.

Ratings (page 54)

You can limit play of DVDs unsuitable for some audiences, children, for example. Play and changes to the settings are not possible unless you enter a password.

Setting ratings (When level 8 is selected)

[8 No Limit]: All DVD-Video can be played.

[1] to [7]: Prohibits play of DVD-Video with corresponding ratings recorded on them.

[0 Lock All]: Prohibits play of all DVD-Video.

Changing ratings (When level 0–7 is selected)

[Unlock Recorder] [Change Password]

[Change Level] [Temporary Unlock]

Language code list

Abkhazian: 6566	Chinese: 9072	Hausa: 7265	Lithuanian: 7684	Romanian: 8279	Telugu: 8469
Afar: 6565	Corsican: 6779	Hebrew: 7387	Macedonian: 7775	Russian: 8285	Thai: 8472
Afrikaans: 6570	Croatian: 7282	Hindi: 7273	Malagasy: 7771	Samoan: 8377	Tibetan: 6679
Albanian: 8381	Czech: 6783	Hungarian: 7285	Malay: 7783	Sanskrit: 8365	Tigrinya: 8473
Ameharic: 6577	Danish: 6865	Icelandic: 7383	Malayalam: 7776	Scots Gaelic: 7168	Tonga: 8479
Arabic: 6582	Dutch: 7876	Indonesian: 7378	Maltese: 7784	Serbian: 8382	Turkish: 8482
Armenian: 7289	English: 6978	Interlingua: 7365	Maori: 7773	Serbo-Croatian: 8372	Turkmen: 8475
Assamese: 6583	Esperanto: 6979	Irish: 7165	Marathi: 7782	Shona: 8378	Twì: 8487
Aymara: 6588	Estonian: 6984	Italian: 7384	Moldavian: 7779	Sindhi: 8368	Ukrainian: 8575
Azerbaijani: 6590	Faroese: 7079	Japanese: 7465	Mongolian: 7778	Singhalese: 8373	Urdu: 8582
Bashkir: 6665	Fiji: 7074	Javanese: 7487	Nauru: 7865	Slovak: 8375	Uzbek: 8590
Basque: 6985	Finnish: 7073	Kannada: 7578	Nepali: 7869	Slovenian: 8376	Vietnamese: 8673
Bengali, Bangla: 6678	French: 7082	Kashmiri: 7583	Norwegian: 7879	Somali: 8379	Volapük: 8679
Bhutani: 6890	Frisian: 7089	Kazakh: 7575	Oriya: 7982	Spanish: 6983	Welsh: 6789
Bihari: 6672	Galician: 7176	Kirghiz: 7589	Pashto, Pushto: 8083	Sundanese: 8385	Wolof: 8779
Breton: 6682	Georgian: 7565	Korean: 7579	Persian: 7065	Swahili: 8387	Xhosa: 8872
Bulgarian: 6671	German: 6869	Kurdish: 7585	Polish: 8076	Swedish: 8386	Yiddish: 7473
Burmese: 7789	Greek: 6976	Laotian: 7679	Portuguese: 8084	Tagalog: 8476	Yoruba: 8979
Byelorussian: 6669	Greenlandic: 7576	Latin: 7665	Punjabi: 8065	Tajik: 8471	Zulu: 9085
Cambodian: 7577	Guarani: 7178	Latvian, Lettish: 7686	Quechua: 8185	Tamil: 8465	
Catalan: 6765	Gujarati: 7185	Lingala: 7678	Rhaeto-Romance: 8277	Tatar: 8484	

- Underlined items are the factory presets.

Picture

Hybrid VBR Resolution (REC)

Switch between automatic and fixed hybrid VBR resolution when recording.

[Automatic] [Fixed]

Automatic

The unit automatically switches resolution rates during recording according to the image. The unit reduces block noise, which occurs during MPEG compression, by selecting the optimum rate.

Fixed

The resolution rate is fixed to ensure the resolution rate is not reduced.

Still Mode (PLAY)

Select the type of picture shown when you pause play.

[Automatic] [Field] [Frame]

Field

Less blurred field stills are shown. Select if jittering occurs when "Automatic" is selected.

Frame

Sharper frame stills are shown. Select if small text or fine patterns cannot be seen clearly when "Automatic" is selected.

Sound

PLAY ×1.3 & Audio during Search (PLAY) (page 14)

[RAM] [DVD-R] [DVD-V] [VCD]

Choose whether to operate the Quick View (Play ×1.3) or not and whether to have sound during search.

[On] [Off]

Dynamic Range Compression (PLAY)

[DVD-V] (Dolby Digital only)

Change the dynamic range for late night viewing.

[On] [Off]

Bilingual Audio Selection (REC) (page 16)

Select whether to record the main or secondary audio type when recording to DVD-R.

[M1] [M2]

Digital Audio Output (PLAY)

(Press [ENTER] **10** to show the following settings. To return to the previous screen, press [RETURN] **23**.)

PCM Down Conversion (page 54)

[On] [Off]

- Select "On" when using a copyright protected disc, since the audio output does not work.

Dolby Digital (page 54)

Choose whether to output Dolby Digital bitstream signals for decoding on other equipment or to convert them to PCM signals for 2-channel output.

[Bitstream] [PCM]

DTS (page 54)

Choose whether to output DTS bitstream signals for decoding on other equipment or to not output signals at all.

[Bitstream] [Off]

MPEG (page 54)

Choose whether to output MPEG bitstream signals for decoding on other equipment or to convert them to PCM signals for 2-channel output.

[Bitstream] [PCM]

- Underlined items are the factory presets.

■ Display

On-Screen Messages

Choose whether to show on-screen messages automatically or not.

[Automatic] [Off]

Grey Background

Select whether to show the grey background, normally shown when television reception is poor.

[On] [Off]

Channel Guide

[On] [Off]

On

The Channel Guide will appear for a few seconds each time the channel is changed with [V, ▲, CH] **18**.

Off

The Channel Guide will not appear.

FL Display

Changes the brightness of the unit's display.

[Bright] [Dim] [Automatic]

Automatic

In standby mode: Off
During normal play: Dim
Others: Bright

■ Connection

TV Aspect (page 12)

Choose the setting to suit your television and preference.

[Norm (4:3)] [Wide (16:9)]

Progressive (NTSC)

[On] [Off]

On

Select when connecting to a NTSC television with component video input terminals.

Off

Select when connecting to a PAL television.

TV System

[PAL] [NTSC]

PAL

Select when connecting to a PAL or Multi-system television. Select to record television programmes and PAL input from other equipment.

NTSC

Select when connecting to a NTSC television. Select to record NTSC input from other equipment. Television programmes cannot be recorded properly.

- To change the TV system (PAL/NTSC) setting:
While stopped, keep pressing [■] **7** and [▲, OPEN/CLOSE] **27** on the main unit for 5 or more seconds.
- If the playback picture on the TV screen from a Video CD isn't shown correctly:
 - When connecting to Multi-system TV, select "NTSC". (After viewing the disc, return the setting to "PAL".)
 - When connecting to PAL TV, the lower part of the picture cannot be displayed correctly during the fast forward and rewind.

Norm (4:3) TV Settings (DVD-Video)

You can select how to reflect the image on the TV, when you watch 16:9 images (DVD-Video) on 4:3 TV.

[Pan & Scan] [Letterbox]

Pan & Scan

Video recorded for a widescreen is played with the sides cut off if the pan & scan was specified by the producer of the disc. 16:9 software prohibited from being shown in the pan & scan style will appear in the letterbox style (with black bands above and below the picture) despite the setting here.



Letterbox

Video recorded for a widescreen is played in the letterbox style.



Norm (4:3) TV Settings (DVD-RAM)

You can select how to reflect the image on the TV, when you watch 16:9 images (DVD-RAM) on 4:3 TV.

[Norm (4:3)] [Pan & Scan] [Letterbox]

Norm (4:3)

Programmes played as recorded.

Pan & Scan

Video recorded for a widescreen is played with the sides cut off if the pan & scan format is specified at the time of recording.

Letterbox

Video recorded for a widescreen is played in the letterbox style.

Entering a password (Ratings)

You can limit play of DVDs unsuitable for some audiences, children, for example. Play and changes to the settings are not possible unless you enter a password.

When setting ratings

The password screen is shown when you select levels 0 to 7.

- 1) Input a 4-digit password with the numeric buttons **4**.
 - If you enter a wrong number, press [**◀**] **10** to erase it before you press [ENTER] **10**.
 - **Do not forget your password.**
- 2) Press [ENTER] **10**.
- 3) Press [ENTER] **10**.

The password is entered and the unit is locked.

Now, when you insert a DVD-Video that exceeds the ratings limit you set, a message appears on the television. Follow the on-screen instructions.

When changing ratings

The password screen is shown when you select "Ratings".

- 1) Input a 4-digit password with the numeric buttons **4** and press [ENTER] **10**.
 - Unlock Recorder:** To unlock the unit and return the rating to 8
 - Change Password:** To change your password
 - Change Level:** To change the rating level
 - Temporary Unlock:** To temporarily unlock the unit (the unit locks again if you switch it to standby or open the disc tray)
- 2) Select the item with [**▲**, **▼**] **10** and press [ENTER] **10**.
Actual screens depend on the operation. Follow the on-screen instructions.

Digital output

Change these settings when you have connected equipment through this unit's OPTICAL DIGITAL AUDIO OUT terminal.

PCM Down Conversion

Off (Factory preset):

When you have used audio cables to connect the unit to other equipment (analog connection [B] page 47).

On:

When you have used an optical digital cable to connect the unit to other equipment (digital connection [A] page 47). Output is limited to 48 kHz/16 bit.

Output of audio with a sampling frequency of 96 kHz

Audio is output as follows in accordance with the connections and settings you make.

Setting	Connection	
	[A] (digital)	[B] (analog)
Off	No output*1	Output as 96 kHz
On	Converted and output as 48 kHz/16 bit	Converted and output as 48 kHz

*1 Audio is output at 96 kHz if the DVD is unprotected, but the connected equipment must be able to handle such signals in order to play them.

Dolby Digital

Bitstream (Factory preset):

When you have connected a unit with a built-in Dolby Digital decoder.

PCM:

When you have connected a unit that doesn't have a built-in Dolby Digital decoder.*2

DTS

Off (Factory preset):

When you have connected a unit that doesn't have a built-in DTS decoder.*2

Bitstream:

When you have connected a unit with a built-in DTS decoder.

MPEG

Bitstream:

When you have connected a unit with a built-in MPEG decoder.

PCM (Factory preset):

When you have connected a unit that doesn't have a built-in MPEG decoder.*2

*2 Set "Dolby Digital" to "PCM", "DTS" to "Off" and "MPEG" to "PCM" if the other equipment doesn't have decoders. Incorrect settings can cause noise to be output which can be harmful to your ears and speakers, and audio will not be recorded properly to digital recording equipment.

Remote Setting

Preparations

- Switch [DVD, TV] **15** to "DVD".
- Press [FUNCTIONS] **11** to show the FUNCTIONS window.

- 1 Use [**▲**, **▼**, **◀**, **▶**] **10** to select "SETUP" and press [ENTER] **10**.
 - The SETUP screen appears.

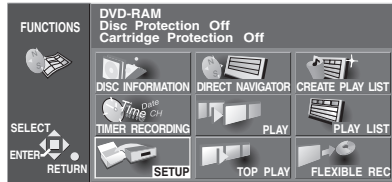

- 2 Use [**▲**, **▼**] **10** to select the "Settings" tab and press [**◀**] or [**▶**] **10**.

(DMR-E51GCS)

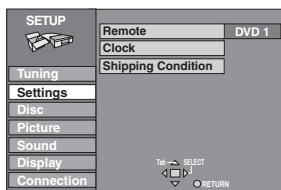

(DMR-E50GN)

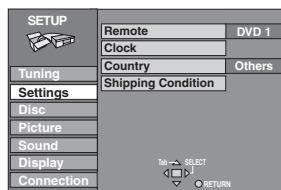

- 3 Use [**▲**, **▼**] **10** to select "Remote" and press [ENTER] **10**.
- 4 Use [**▲**, **▼**] **10** to select "DVD 1", "DVD 2" or "DVD 3" and press [ENTER] **10**.
 - DVD 1:

Select this setting on both the unit and the remote control for normal use with one unit.
 - DVD 2/DVD 3:

Select this setting on both the unit and the remote control when using this unit and another Panasonic unit in the same place. This ensures that you can operate both units independently with their respective remote control. It also allows you to operate both units with a single remote control, simply by changing the remote control mode on the remote control.
- 5 To change the remote control mode on the remote control itself, press [ENTER] **10** and the numeric buttons **4** corresponding to the code you want to set, [1], [2] or [3], at the same time for about 2 seconds.
- 6 Press [RETURN] **23**.

Operating other Panasonic DVD equipment with the remote control

By changing the remote control code, you can operate other DVD recorders and players manufactured by Panasonic.

Most of the DVD recorders and players manufactured by Panasonic use the same system for their remote controls, so if you operate them in the same place, the controls can be confused by the different pieces of equipment. Use the following procedure to change the remote control code to solve this problem.

- Use "1", the factory set code, under normal circumstances.

Preparation

- Switch [DVD, TV] **15** to "DVD".

Press [ENTER] **10** and the numeric buttons **4** corresponding to the code you want to set, [1], [2] or [3], at the same time for about 2 seconds.

Notes

- Be sure to set the same remote control code on the main unit as you did for the remote control itself (page 51, "Settings" — "Remote").
- The following display appears on the unit's display if its code and the remote control's code are different. Change the remote control's code to suit the unit.



The unit's remote control code

- The display disappears after about 5 seconds.

Clock Settings

Preparations

- Switch [DVD, TV] **15** to "DVD".
- Press [FUNCTIONS] **11** to show the FUNCTIONS window.

- 1 Use [▲, ▼, ◀, ▶] **10** to select "SETUP" and press [ENTER] **10**.
 - The SETUP screen appears.

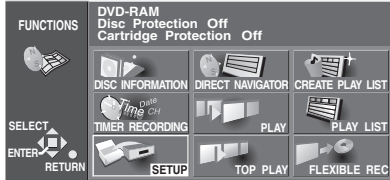

- 2 Use [▲, ▼] **10** to select the "Settings" tab and press [◀] or [▶] **10**.

(DMR-E51GCS)

(DMR-E50GN)

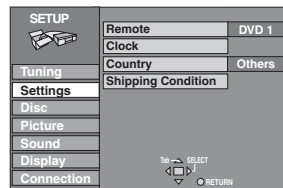
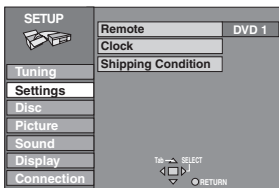

- 3 Use [▲, ▼] **10** to select "Clock" and press [ENTER] **10**.

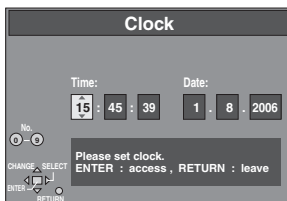

- 4 Use [◀, ▶] **10** to select the item you want to change.

- The items change as follows:
Hour→Minute→Second→Day→Month→Year

- 5 Use [▲, ▼] **10** to change the setting.
 - You can also use the numeric buttons **4** for setting.
- 6 Press [ENTER] **10**.
 - The SETUP screen reappears and the clock starts.
- 7 Press [RETURN] **23**.

Note

- In the event of a power failure, the clock will operate on its back up system for a minimum of 3 years.

Channel Settings

Preparations

- Switch [DVD, TV] **15** to "DVD".
- Press [FUNCTIONS] **11** to show the FUNCTIONS window.

Selecting the manual tuning

- 1 Use [▲, ▼, ◀, ▶] **10** to select "SETUP" and press [ENTER] **10**.
 - The SETUP screen appears.
- 2 Use [▲, ▼] **10** to select the "Tuning" tab and press [◀] or [▶] **10**.
- 3 Use [▲, ▼] **10** to select "Manual" and press [ENTER] **10**.

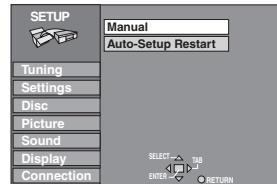

- 4 Use [▲, ▼] **10** to select the TV station that you want to tune and press [ENTER] **10**.
 - The TUNING BOX screen appears.

(DMR-E51GCS)

(DMR-E50GN)

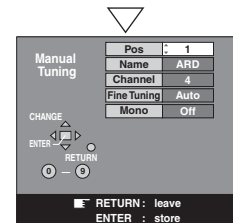
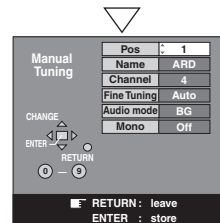
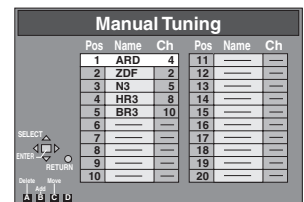
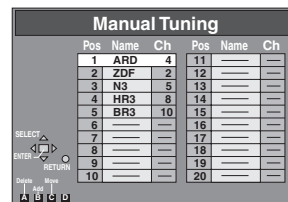

Handling the TUNING BOX screen

- Use [▲, ▼, ◀, ▶] **10** to select the desired field and press [ENTER] **10**.

Pos:

To change the order in which the TV stations are assigned to the programme positions.

Press the numeric buttons **4** to enter the number of the desired programme position.

Name:

To enter or change the name of a TV station.

Use [▲, ▼, ◀, ▶] **10** to enter station name and press [ENTER] **10**.

- If the station name needs a blank space, select the blank between [Z] and [*].

Channel:

To enter newly available TV stations or change the channel number of an already tuned TV station.

Press the numeric buttons **4** to enter the channel number of the desired TV station.

- Wait a few moments until the desired TV station has been tuned.
- After the desired TV station is tuned, press [ENTER] **10**.

Fine Tuning:

To obtain the best tuning condition.

Use [▲, ▼] **10** to obtain the best tuning condition.

- If you do not want to change the tuning condition, Use [▶] **10** to return to the original condition [Auto].

Audio mode: (DMR-E51GCS only)

To select Audio mode then select the broadcasting system.

Use [▲, ▼] **10** to select "BG", "I", or "DK".

- BG: PAL B.G.H
- I: PAL I
- DK: PAL D.K.K1

Mono:

To select the type of sound to be recorded.

Use [▲, ▼] **10** to select "Off".

- Select "On" if the stereo sound is distorted due to inferior reception conditions, or if you want to record the normal (mono) sound during a stereo, bilingual or NICAM broadcast.

5 Press [RETURN] **23.**

Adding, deleting and moving channels

Use this function if:

- Channels were not set correctly using automatic tuning.
- A channel that should have been set wasn't.
- A channel's reception is poor and you want to delete it.

Preparations

- Switch [DVD, TV] **15** to "DVD".
- Press [FUNCTIONS] **11** to show the FUNCTIONS window.

- 1 Use [▲, ▼, ◀, ▶] **10** to select "SETUP" and press [ENTER] **10**.
 - The SETUP screen appears.
- 2 Use [▲, ▼] **10** to select the "Tuning" tab and press [◀] or [▶] **10**.
- 3 Use [▲, ▼] **10** to select "Manual" and press [ENTER] **10**.

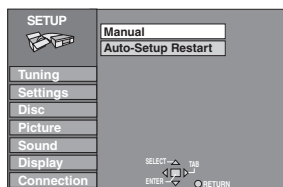

- 4 Use [▲, ▼, ◀, ▶] **10** to select the desired TV station and use the [A], [B], [C] buttons (**29**, **28**, **33**) to select "Delete", "Add", "Move".

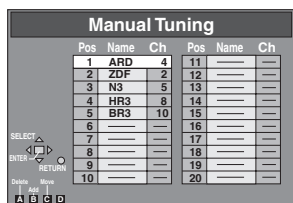

Follow the operations below.

To delete a programme position "Delete":

Press [A] **29**.

To insert a blank programme position "Add":

Press [B] **28**.

To move a TV station to another programme position "Move":

Press [C] **33**, and then use [▲, ▼] **10** to select the new programme position to which you want to assign the TV station. Press [ENTER] **10**.

5 Press [RETURN] **23.**

Note

- Setting can take up to 3 minutes approximately.

Hint

- If you have performed Manual Tuning to enter TV stations, the [—] indication may appear under [Pos/Name] on the display when programming a G-CODE timer recording.

List of TV Reception Channels

For DMR-E51GCS

SYSTEM		VHF	UHF	CATV
B G	CCIR Standard (B.G.H)	E2-E12	E21-E69	S01-S05 M1-M10 U1-U10 S21-S41
I	Hong kong Special Administrative Region of China (I)	—	21-69	—
D K	OIRT (D.K.K1)	R1-R12	21-69	44-470MHz
	China (D)	1-12	13-57	Z1-Z35

For DMR-E50GN

Country	VHF	UHF	CATV
Australia	0-12	28-69	45-470MHz
New Zealand	1-11	21-69	44-470MHz

Auto-Setup Restart

You can use the SETUP menus to start Auto Channel setting if Auto Setup (page 12) fails for some reason.

Preparations

- Switch [DVD, TV] **15** to "DVD".
- Press [FUNCTIONS] **11** to show the FUNCTIONS window.

- 1 Use [▲, ▼, ◀, ▶] **10** to select "SETUP" and press [ENTER] **10**.
 - The SETUP screen appears.
- 2 Use [▲, ▼] **10** to select the "Tuning" tab and press [◀] or [▶] **10**.

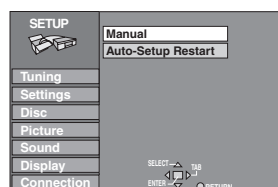

- 3 Use [▲, ▼] **10** to select "Auto-Setup Restart" and press [ENTER] **10**.
 - A message appears asking you to confirm the operation.
- 4 Use [◀] **10** to select "Yes" and press [ENTER] **10**.
 - Auto Setup starts. This takes about 5 minutes.

The clock setting menu appears after Auto Setup finishes

- (1) Use [▲, ▼, ◀, ▶] **10** to set the correct time and date.
- (2) Press [ENTER] **10** to conclude the setting.

Country Settings (DMR-E50GN only)

Preparations

- Switch [DVD, TV] **15** to "DVD".
- Press [FUNCTIONS] **11** to show the FUNCTIONS window.

- 1 Use [▲, ▼, ◀, ▶] **10** to select "SETUP" and press [ENTER] **10**.
• The SETUP screen appears.
- 2 Use [▲, ▼] **10** to select the "Settings" tab and press [◀] or [▶] **10**.
- 3 Use [▲, ▼] **10** to select "Country" and press [ENTER] **10**.



- 4 Use [▲, ▼] **10** to select the desired country and press [ENTER] **10**.
- 5 Press [RETURN] **23**.

Shipping Condition

The all settings in the SETUP screen return to the factory settings. (except for the ratings level and the password)

Preparations

- Switch [DVD, TV] **15** to "DVD".
- Press [FUNCTIONS] **11** to show the FUNCTIONS window.

- 1 Use [▲, ▼, ◀, ▶] **10** to select "SETUP" and press [ENTER] **10**.
• The SETUP screen appears.
- 2 Use [▲, ▼] **10** to select the "Settings" tab and press [◀] or [▶] **10**.
- 3 Use [▲, ▼] **10** to select "Shipping Condition" and press [ENTER] **10**.

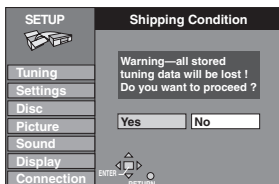

- 4 Use [◀, ▶] **10** to select "Yes" and press [ENTER] **10**.
- 5 Use [◀, ▶] **10** to select "Yes" and press [ENTER] **10**.

Status displays

Changing the information displayed

Displays appear on the television when you operate the unit to let you know what operation was performed and what condition the unit is in.

Remote control only

Preparation

- Switch [DVD, TV] **15** to "DVD".

Press [STATUS] **28** to change the information displayed.

The display changes each time you press the button. For example, DVD-RAM

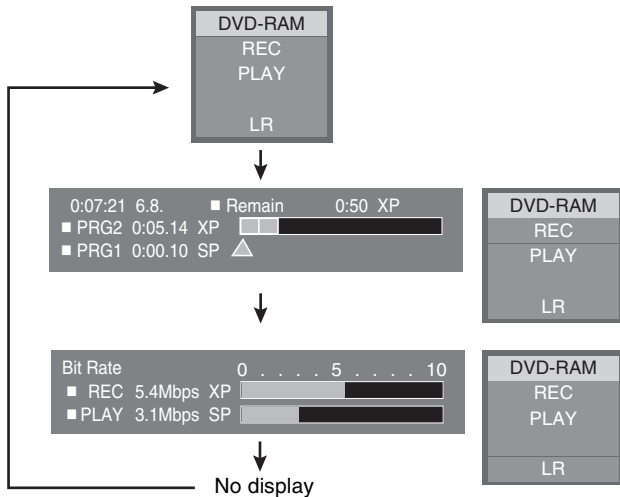

Display examples

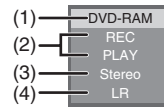

(1) Current media

(2) Current recording or play status, input channel

- Shows the current state of the unit, and the input channel.

REC: Recording

PAUSE: Recording paused

PLAY: Playing

PLAY ×1.3: Quick Viewing (Play ×1.3)

||: Playing Paused

▶▶: Fast forwarding (5 speeds)

◀◀: Rewinding (5 speeds)

▶: Slow-motion (5 speeds)

◀: Reverse slow-motion (5 speeds)

(3) Audio type

- Shows the selected audio type.

Stereo: a stereo broadcast is being received

M1/M2: a multiple audio broadcast is being received

M1: a NICAM monaural broadcast is being received

(4) Sound mode

- **LR, L, R:** when you have changed the audio with the remote control's [AUDIO] **31**

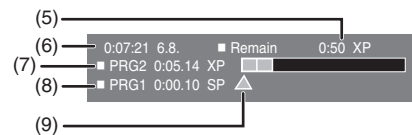

(5) Available recording time and recording mode

- (e.g.: "0:50 XP" indicates 50 minutes in XP mode)

(6) The current date and time

(7) Recording time

- Shows recording time, recording mode and a rough guide to how much space has been used for recording on the disc.

(8) Elapsed play time

(9) Play position

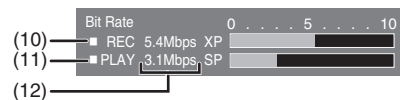

(10) Video bit-rate when recording

(11) Video bit-rate when playing

(12) Bit-rate display

- Shows as Mbps (Mega-bit per seconds) during play and recording, or kbit (kilobit) while paused.
- The method of calculating bit-rate for recording and playing is different so there may be differences in the figures displayed. (Values are approximate.)

For your reference

- These displays may not be shown if "On-Screen Messages" in the "Display" menu is set to "Off" (page 53). If set to "Automatic", displays (1), (2), (3) and (4) appear for 5 seconds and then disappear.

Maintenance and Handling

Maintenance

To clean this unit, wipe with a soft, dry cloth.

- Never use alcohol, paint thinner or benzene to clean this unit.
- Before using chemically treated cloth, read the instructions that came with the cloth carefully.

Dust and dirt may adhere to the unit's lenses over time, possibly making it impossible to record or play discs.

Use the recommended **DVD-RAM/PD lens cleaner (LF-K123LCA1)** every 1 to 4 months, depending on frequency of use and the operating environment.

Read the lens cleaner's instructions carefully before use.

- The lens cleaner may make some sound during use but this does not indicate a malfunction.
- "NO READ" appears on the unit's display when cleaning finishes.

The precision parts in this unit are readily affected by the environment, especially temperature, humidity and dust.

Observe the following points to ensure continued listening and viewing pleasure.

Disc handling

Do not use irregularly shaped discs, such as heart-shaped.
(These can damage the unit.)

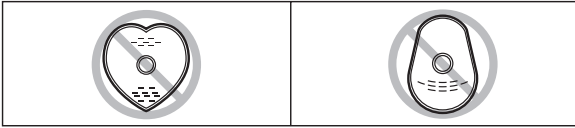

How to hold a disc

Do not touch the recorded surface.

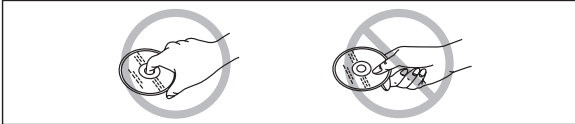

If there is dirt or condensation on the disc

If the disc is dirty, wipe with a damp cloth and then wipe dry.

Moisture may condense on discs after they are brought inside from the cold.

DVD-RAM and DVD-R

- Clean and dry with an optional DVD-RAM/PD disc cleaner (**LF-K200DCA1**, where available). Do not use cleaners or clothes for CDs to clean DVD-RAM and DVD-R.
- Never use cloths or cleaners for CDs, etc.

DVD-Video, Video CD and CD

Wipe it with a damp cloth and then wipe dry.

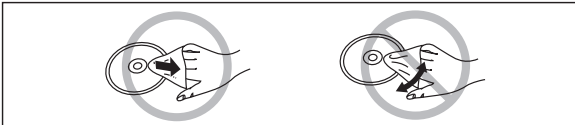

Handling precautions

- Do not write on the label side with a ball-point pen or other writing instrument.
- Do not use record cleaning sprays, benzene, thinner, static electricity prevention liquids or any other solvent.
- Do not attach labels or stickers to discs. (Do not use discs with exposed adhesive from tape or left over peeled-off stickers.)
- Do not use scratch-proof protectors or covers.
- Do not use discs printed with label printers available on the market.
- Do not use discs that are badly warped or cracked.

Do not place or store discs in the following places

- Locations exposed to direct sunlight
- Humid or dusty locations
- Locations directly exposed to a heat vent or heating appliance.

Glossary

Bitstream

This is the compressed form of digital signals. A decoder decodes these signals into 5.1 surround and multi-channel signals.

Channel (when referring to DVD)

Sound is divided into channels based on the sound's role.

For example, 5.1 channel

- Front speakers—1 left channel and 1 right channel
- Center speaker—1 channel
- Surround speakers—1 left channel and 1 right channel
- Subwoofer—1 channel×0.1 (the ratio of bass to the total amount of sound output)

Examples as shown in the status display

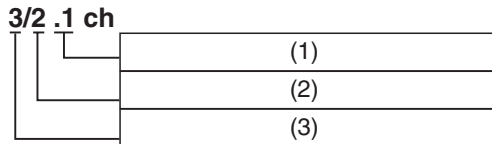

- (1) 1: Subwoofer signal
(not displayed if there is no subwoofer signal)
- (2) 0: No surround
1: Mono surround
2: Stereo surround (left/right)
- (3) 1: Center
2: Front left+Front right
3: Front left+Front right+Center

DIRECT NAVIGATOR

This is a list of programmes you have recorded. You can select programmes from the list to view. The list also shows the date and time of recording, the channel, and the titles of titled programmes. The selected programme is played in the background, making selection even simpler.

Dolby Digital

This is a method of coding digital signals developed by Dolby Laboratories. Apart from stereo (2 channel) audio, these signals can also be 5.1-channel audio. A large amount of audio information can be recorded on one disc using this method.

Dolby Pro Logic

A surround system where a 4-channel audio track is recorded as 2 channels and then is restored to 4 channels for play. The surround channel is monaural.

DTS Digital Surround

This surround system is used in many movie theaters around the world. The separation between channels is good and the compression ratio is low, so realistic sound effects are possible. DTS soundtracks are produced with the assumption that all channels will be used.

Film and video

DVD-Video are recorded using either film or video. Usually, film is recorded at 24 frames per second, the rate movies are filmed at, while video is recorded at 30 frames per second.

Finalize

This process allows DVD-R to be played on compatible equipment.

Frame and field

Frames are the still pictures that go together to make a moving picture. A frame is made up of 2 fields.

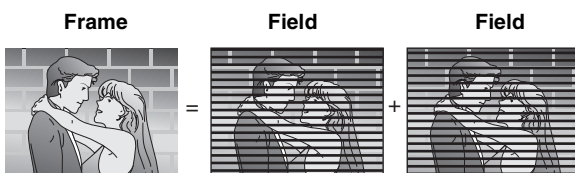

- A frame still is made up of two alternating fields, so the picture may appear blurred, but overall quality is high.
- A field still is not blurred, but it has only half the information of a frame still so picture quality is lower.

Interlace and progressive output

NTSC has 480 interlaced (i) scan lines, whereas progressive scanning uses twice the number of scan lines. This is called 480p. The video signals output from this unit's COMPONENT VIDEO OUT terminals (Y, P_B, P_R) allow you to enjoy higher quality pictures than if the signals were output from the VIDEO OUT terminal or S-VIDEO OUT terminal.

Linear PCM

This is a form of signal that has been digitized without compressing it. CDs are recorded with 44.1 kHz/16 bit PCM, while DVDs use PCM between 48 kHz/16 bit and 96 kHz/24 bit, allowing reproduction of greater quality sound. The linear PCM signals output from the DIGITAL AUDIO OUT, OPTICAL terminal are stereo (2 channel).

NICAM (NICAM Broadcasting System)

This is a 2 channel sound broadcast system which in most instances provides high quality stereo sound. Broadcasters can also transmit two separate mono soundtracks on this system.

Pan&Scan/Letterbox

In general, DVD-Video are produced with the intention that they be viewed on a widescreen television with an aspect ratio of 16:9. This means you can view most material with the intended aspect ratio on a widescreen television.

Material with this ratio will not fit onto a standard television with an aspect ratio of 4:3. Two styles of picture, "Pan&Scan" and "Letterbox", deal with this problem.

Pan&Scan: The sides are cut off so the picture fills the screen.



Letterbox: Black bands appear at the top and bottom of the picture so the picture itself appears in an aspect ratio of 16:9.



Playback control (PBC)

This is a method of playing Video CDs. You can select parts to play by using menus recorded on the disc.

PLAY LIST

This is a collection of scenes. It enables you to play these scenes in succession or to select specific ones to play.

Programme (PRG)

The section between the point where recording is started and the point where it is stopped.

Sampling frequency

This is the number of samples of sound taken per second during conversion to a digital signal. A high sampling frequency results in a sound close to the original when played back.

S-video output

The colour and luminance signals are separated before being sent to the television, making for greater picture clarity.

Title/Chapter (DVD-Video)

DVD-Video are divided up into large sections, titles, and smaller sections, chapters. The numbers allocated to these sections are called title numbers and chapter numbers.

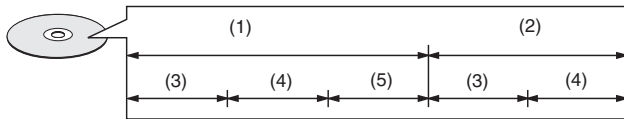
Example

- (1) Title 1
- (2) Title 2
- (3) Chapter 1
- (4) Chapter 2
- (5) Chapter 3

Track

This is the smallest division on CD, and Video CD, and usually equates to a single song.

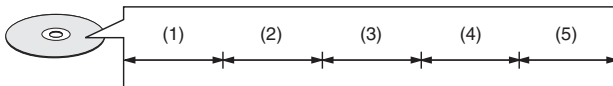
Example

- (1) Track 1
- (2) Track 2
- (3) Track 3
- (4) Track 4
- (5) Track 5

Self-diagnosis

The self-diagnosis displays appear if a problem occurs with the unit.

The service numbers in the table appear when a problem occurs.

- The service numbers are a "U" followed by two digits.

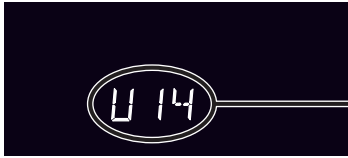

Service number

Service number	Unit status	Solutions
NO READ	The disc is dirty or badly scratched.	<ul style="list-style-type: none"> • Follow the instructions in "Maintenance and Handling" to clean the disc if it is dirty. (page 60) • The disc cannot be played if it is scratched and this display doesn't disappear.
	It can not be read for the disk which doesn't cope with it.	<ul style="list-style-type: none"> • It can not be read for the disk which doesn't cope with it. Exchange a disk.
	The DVD-RAM/PD lens cleaner has finished cleaning.	<ul style="list-style-type: none"> • Take the cleaner out of the unit.
UNSUPPORT	You have inserted a disc the unit cannot play or record on.	<ul style="list-style-type: none"> • Insert a disc the unit can play or record on. (page 8)
U14	The unit is hot.	<ul style="list-style-type: none"> • The unit switches to standby automatically for safety reasons and you cannot operate it. Wait for about 30 minutes for the service number to disappear. • Select a position with good ventilation when installing the unit. • Do not block the cooling fan on the rear of the unit.
U99	The unit fails to operate properly.	<ul style="list-style-type: none"> • Press [⏻/⏻] 1 to switch the unit to standby. Now press [⏻/⏻] 1 again to turn the unit on.
REMOTE DVD	The remote control code is wrong.	<ul style="list-style-type: none"> • Change to the correct code. (page 55)
RECOVER	A power failure occurred or the AC mains plug was disconnected while the power was ON.	<ul style="list-style-type: none"> • The unit is carrying out its recovery process. Wait until the message disappears.

Error displays

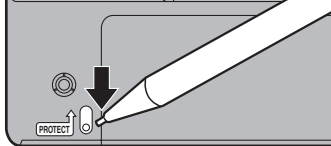
Error messages	Causes and solutions
No Disc.	<ul style="list-style-type: none"> You haven't inserted a disc. Correctly insert a disc that this unit can play. (page 13) The disc is upside down. If it is a single-sided disc, insert it so the label is facing up. (page 13)
This is a non-recordable disc. Cannot record. This disc is not properly formatted. Formatting is necessary using DISC INFORMATION.	<ul style="list-style-type: none"> The unit cannot record on the disc you inserted. The unit cannot record onto finalized DVD-R, DVD-Video, CDs or Video CDs. Insert a DVD-RAM or unfinalized DVD-R. (page 8) You inserted an unformatted DVD-RAM. Format the disc with this unit. (page 31)
This disc cannot be read.	<ul style="list-style-type: none"> You inserted an incompatible disc. (page 13)
Please check write protect tab on the disc.	<ul style="list-style-type: none"> The write protect tab on the cartridge is set to "PROTECT". Use a ballpoint pen or similar to release the write protection. 
Contents of this disc are protected.	<ul style="list-style-type: none"> The programme is write-protected. Release the protection with the direct navigator. (page 35) The disc is write-protected. Release the protection with the disc protection sub menu of DISC INFORMATION. (page 30)
Cannot finish recording completely.	<ul style="list-style-type: none"> The programme was copy-protected. TV system of the programme was different from the setting in SETUP, so the timer recorded was not completed. The disc is full. Recording was not completed for some other reason.
Cannot record on the disc.	<ul style="list-style-type: none"> The disc is scratched. Use another disc. The disc is dirty. Clean the disc as described in these operating instructions. (page 60)
Cannot record to the disc. TV system of input signal is different to the setting in SETUP.	<ul style="list-style-type: none"> TV system of the programme or the input signal was different from the setting in SETUP.
Disc is full.	<ul style="list-style-type: none"> No space left on the disc. Create space by erasing any unwanted programmes. (page 34) Use a new disc.
Please set clock.	<ul style="list-style-type: none"> The clock is not set correctly. Reset the clock using "Clock Settings". (page 56)
This disc may not be played in your region.	<ul style="list-style-type: none"> You tried to play a disc with a region number different from this unit's region number. This unit can play only play discs with the region numbers compatible with this unit. (page 8)
Your selection exceeds the recorder's rating limit.	<ul style="list-style-type: none"> A ratings level has been set for DVD-Video with this unit. Temporarily unlock the unit with "Ratings" in the disc menu. (page 54)
Error has occurred. Please press ENTER.	<ul style="list-style-type: none"> You can operate the unit using the [ENTER] 10 only. After you press the [ENTER] 10, turn off the unit and then turn it on. Recovery starts.
Please check the disc.	<ul style="list-style-type: none"> Check the discs for dirt or scratches. (page 60)
Please change the disc.	<ul style="list-style-type: none"> You can operate the unit using the [▲, OPEN/CLOSE] 27 only. Press [▲, OPEN/CLOSE] 27 to open the tray and eject a disc, the unit becomes off. To continue play or recording, insert an another disc.
Finalizing is necessary for compatible playback.	<ul style="list-style-type: none"> To enable playback of your DVD-R on compatible equipment, it is necessary to finalize it. (page 32)
Please check write protect tab.	<ul style="list-style-type: none"> Release the protection on the DVD-RAM.

Troubleshooting guide

Before requesting service, make the below checks. If you are in doubt about some of the check points, or if the remedies indicated in the chart do not solve the problem, consult your dealer for instructions.

Power

No power	<ul style="list-style-type: none"> ● Insert the AC power supply cord securely into the household AC outlet.
The unit is on but cannot be operated.	<ul style="list-style-type: none"> ● The unit is hot ("U14" appears on the display). Wait for "U14" to disappear. ● One of the unit's safety devices may have activated. Reset the unit as follows: <ol style="list-style-type: none"> (1) Press [⏻/⏪] 1 on the main unit to switch the unit to standby. If the unit doesn't switch to standby, press and hold [⏻/⏪] 1 for about 10 seconds. The unit is forcibly switched to standby. Alternatively, disconnect the AC power supply cord, wait one minute, then reconnect it. (2) Press [⏻/⏪] 1 to turn the unit on.
The unit switches to standby automatically.	<ul style="list-style-type: none"> ● One of the unit's safety devices may have activated. Press [⏻/⏪] to turn the unit on.

Picture

No picture.	<ul style="list-style-type: none"> ● Make sure the television's input setting (e.g., AV1) is correct. (pages 10 and 11) ● You have set "Progressive (NTSC)" to "On" in the Connection menu, but the television is not compatible with progressive signals. Press [■] 7 and [TIME SLIP] 25 on the unit at the same time for about 5 seconds. The setting will change to interlace.
Television reception worsens after connecting the unit.	<ul style="list-style-type: none"> ● This can occur because the signals are being divided between the unit and the television. It can be solved by using a signal booster, available from audio-visual suppliers. Consult your dealer if reception does not improve.
Screen size is wrong.	<ul style="list-style-type: none"> ● Check the settings on your television. ● Check the settings for "TV Aspect", "Norm (4:3) TV Settings (DVD-Video)" or "Norm (4:3) TV Settings (DVD-RAM)" in the Connection menu. (pages 12 and 53)
The picture flickers.	<ul style="list-style-type: none"> ● Adjust the television's vertical hold. Read the television's operating instructions or consult your dealer.
On-screen messages do not appear.	<ul style="list-style-type: none"> ● Go to Display in the SETUP menus and select "Automatic" for "On-Screen Messages". (page 53) Press [STATUS] 23 to show the on-screen messages constantly.
The grey background does not appear.	<ul style="list-style-type: none"> ● Go to Display in the SETUP menus and select "On" for "Grey Background". (page 53)

Progressive video

There is ghosting when you progressive output is on.	<ul style="list-style-type: none"> ● Set "Progressive" to "OFF". This problem is caused by editing method or material used on DVD-Video, but should be corrected if you use interlace out put. (page 44)
There is no apparent change in picture quality when adjusted with the Video menu in the on-screen menus.	<ul style="list-style-type: none"> ● The effect is less perceivable with some types of video.

Sound

No sound. Low volume. Distorted sound.	<ul style="list-style-type: none"> ● Check the connections. (pages 10 and 11) ● Check the input mode on the amplifier if you have connected one. (pages 46, 47 and 54) ● Turn V.S.S. to "OFF" if it causes distortion. (page 44)
Cannot hear the desired audio type.	<ul style="list-style-type: none"> ● Press [AUDIO] 31 on the remote control to select the desired audio type. (page 16) DVD-R ● Go to Sound in the SETUP menus and choose the correct setting with "Bilingual Audio Selection". (page 52)
Cannot switch audio during stereo or NICAM broadcasts.	<ul style="list-style-type: none"> ● You have used digital connection. Connect to other equipment using audio cables (analog connection). (pages 10, 11 and 47) ● You cannot change the audio type when using DVD-R.

Displays

The display is dim.	<ul style="list-style-type: none"> Go to Display in the SETUP menus and change the display's brightness with "FL Display". (page 53)
"0:00" is flashing on the unit's display.	<ul style="list-style-type: none"> The clock is not set. Go to Settings in the SETUP menus and set the clock with "Clock". (page 56)
"NO READ" appears on the unit's display after using a lens cleaner.	<ul style="list-style-type: none"> Take the cleaner out of the unit.

Play

<p>Play fails to start even when [▶] (21) is pressed.</p> <p>Play starts but then stops immediately.</p> <p>"NO READ", "UNSUPPORT", "NO DISC" or "NO PLAY" appears on the unit's display.</p>	<ul style="list-style-type: none"> Insert the disc correctly with the label facing up. (page 13) This unit cannot play discs other than DVD-RAM, DVD-R, DVD-Video, Video CD, CD and MP3 disc. (page 8) The disc is dirty. Clean it. (page 60) The disc may be badly scratched. (page 60) You inserted a blank DVD-RAM or DVD-R.
No response when buttons pressed.	<ul style="list-style-type: none"> If "⊙" appears on the television the operation is prohibited by the unit or disc. If the unit is not operating at all, press [⊖, TIMER] (12) to switch the unit to standby, then press [⊖, TIMER] (12) again to turn the unit on. The unit may not be operating correctly due to lightning, static electricity, or some other external factor. The Child Lock function is activated. (page 46)
A title or chapter doesn't play when it is selected.	<ul style="list-style-type: none"> Some titles and chapters on DVD-Video are not played when you have changed the ratings level. (page 54)
Picture distorted during search.	<ul style="list-style-type: none"> Some distortion is normal.
Alternative soundtrack and subtitles cannot be selected.	<ul style="list-style-type: none"> The languages are not recorded on the disc. You may have to use the disc's own menus to select languages.
Soundtrack/subtitle language not the one selected with the SETUP menus.	<ul style="list-style-type: none"> The language is not recorded on the disc. (page 51)
No subtitles.	<ul style="list-style-type: none"> Subtitles are not recorded on the disc. Turn the subtitles on. (page 43)
Angle cannot be changed.	<ul style="list-style-type: none"> This function depends on software availability. Angles can only be changed during scenes where different angles are recorded ("👤" appears on the display).
You have forgotten your ratings password.	<ul style="list-style-type: none"> Return the unit's settings to the initial state (factory setting). With the tray open, keep pressing [◀◀/▶▶] and [▶▶/▶▶] (42) on the main unit simultaneously for 5 or more seconds.

Remote control

The remote control doesn't work.	<ul style="list-style-type: none"> The unit is on standby to make a timer recording ("⊖" on the unit's display is on). (page 24) [DVD, TV] (15) is not switched to "DVD". Switch to "DVD" when operating this unit. (page 7) The remote control code is wrong. Change to the correct code. (page 55) The batteries are depleted. Replace them with new ones. (page 7) Point the remote control at the remote control sensor on the main unit. (page 7) Remove obstacles from between the remote control and main unit. The Child Lock function is activated. (page 46)
Cannot operate the television.	<ul style="list-style-type: none"> The remote control code is wrong. Change to the correct code. Some televisions cannot be operated even if you change the code. (page 7) [DVD, TV] (15) is not switched to "TV". Switch to "TV" when operating the television. (page 7)

Recording and timer recording

<p>Cannot record.</p>	<ul style="list-style-type: none"> ● You haven't inserted a disc or the disc you inserted cannot be recorded on. Insert a disc the unit can record onto. (page 8) ● The disc is unformatted. Format the disc so this unit can record on it. (page 31) ● The write protect tab on the cartridge is set to "PROTECT". Use a ballpoint pen or similar to release the write protection. (page 64) ● Recording is not possible unless you set "Disc Protection" in "DISC INFORMATION" to "Off". (page 30) ● The disc is full or nearly full. Delete unneeded programmes or use another disc. (page 34) ● The material you are trying to record is copy-guarded. ● Tired to record to a DVD-R that has already been finalized.
<p>G-CODE programming does not work properly.</p>	<ul style="list-style-type: none"> ● The clock is wrong. Go to Settings in the SETUP menus and correct the clock with "Clock". (page 56)
<p>If "--" appears under "Name" after entering a G-CODE number</p>	<ul style="list-style-type: none"> ● Use [▲, ▼] 10 repeatedly to select the programme position on which the TV programme to be recorded will be broadcast. (page 25)
<p>Timer recording does not work properly.</p>	<ul style="list-style-type: none"> ● The timer programme is incorrect. Make corrections to the programme and check them when you are finished. (pages 25 and 26) ● The unit is not on standby for timer recording. ("⊖" on the unit's display is not on.) ● Different timer programme times overlap. (page 24) ● The clock is wrong. Go to Settings in the SETUP menus and correct the clock with "Clock". (page 56)
<p>The unit switches to standby while making a timer recording.</p>	<ul style="list-style-type: none"> ● The unit switches to standby while making a timer recording if the disc runs out of space. Use a disc that has enough space to record the programme.
<p>The timer programme remains even after recording finishes.</p>	<ul style="list-style-type: none"> ● The programme remains if you select weekly or daily setting. (pages 25 and 26)
<p>The available recording time doesn't increase even after erasing all recordings on the disc.</p>	<ul style="list-style-type: none"> ● The available recording time does not increase if you erase data written to the disc with the DVD-RAM drive of a computer. Format the disc if necessary. (page 31) ● If the disc is dirty, wipe with the DVD-RAM/PD lens cleaner (optional) before formatting. ● Available recording space on the DVD-RAM does not increase even after erasing previously recorded programming.
<p>A part or whole of a recorded programme has been lost.</p>	<ul style="list-style-type: none"> ● If there is a power failure or the plug is disconnected from the household AC outlet while recording or editing, the programme may be lost or the disc may become unusable. → We cannot offer any guarantee regarding lost programmes or discs. You will have to format the disc or use a new disc.

<p>Cannot eject a disc.</p>	<ul style="list-style-type: none"> ● Press [DVD, ⏻] 1 to switch the unit off. Hold down [■] 7 and [▲, CH] 18 on the main unit simultaneously for about 5 seconds. ● If the Child Lock function is activated, above operation does not work.
------------------------------------	--

Discs make sounds as they rotate. This does not indicate a malfunction.

Specifications

Power supply:	For Asia (DMR-E51GCS) AC 220-240 V, 50/60 Hz For Australia and New Zealand (DMR-E50GN) AC 220-240 V, 50 Hz
Power consumption:	29 W (Approx. 4 W [Standby mode])

Recording system:	DVD video recording standards (DVD-RAM), DVD video standards (DVD-R)
Recordable discs:	12 cm 4.7 GB DVD-RAM 12 cm 9.4 GB DVD-RAM 8 cm 2.8 GB DVD-RAM 12 cm 4.7 GB DVD-R (for General Ver.2.0) 8 cm 1.4GB DVD-R (for General Ver.2.0)
Recording time:	Maximum 360 min (with 4.7 GB disc) XP: Approx. 60 min SP: Approx. 120 min LP: Approx. 240 min EP: Approx. 360 min
Playable discs:	12 cm 4.7 GB DVD-RAM 12 cm 9.4 GB DVD-RAM 8 cm 2.8 GB DVD-RAM 12 cm 4.7 GB DVD-R (for General Ver.2.0) 8 cm 1.4 GB DVD-R (for General Ver.2.0) DVD-Video CD-Audio (CD-DA) Video CD CD-R/RW (MP3, CD-DA, Video CD formatted discs)

Audio	
Recording system:	Dolby Digital 2ch
Audio In:	AV1/AV2/AV3 IN (pin jack)
Input Level:	Standard: 0.5 Vrms Full scale: 2.0 Vrms at 1 kHz
Input Impedance:	more than 10 kohm
Audio Out:	OUT (pin jack)
Output Level:	Standard: 0.5 Vrms Full scale: 2.0 Vrms at 1 kHz
Output Impedance:	less than 1 kohm
Digital Audio Out:	Optical terminal (PCM, Dolby Digital, DTS, MPEG)

Television System	
Tuner System:	For Asia (DMR-E51GCS) PAL BGH/I/DK For Australia and New Zealand (DMR-E50GN) PAL BGH
RF Converter Output:	Not provided

Video	
Video System:	PAL colour signal, 625 lines, 50 fields NTSC colour signal, 525 lines, 60 fields
Recording system:	MPEG2 (Hybrid VBR)
Video In:	AV1/AV2/AV3 IN (pin jack) 1 Vp-p 75 ohm, terminated
S-Video In:	AV1/AV2/AV3 IN (S connector) 1 Vp-p 75 ohm, terminated
Video Out:	OUT (pin jack) 1 Vp-p 75 ohm, terminated
S-Video Out:	OUT (S connector) 1 Vp-p 75 ohm, terminated
Component video output (NTSC 480P/480I) (PAL 576I)	
Y:	1.0 Vp-p 75 ohm, terminated
PB:	0.7 Vp-p 75 ohm, terminated
PR:	0.7 Vp-p 75 ohm, terminated

Dimensions	
(W)×(H)×(D):	Approx. 430×79×283 mm
Mass:	Approx. 3.8 kg
Operating	
Temperature:	5°C–40°C
Operating	
Humidity range:	10%–80% RH (no condensation)

LASER Specification	
Class 1 LASER Product	
Wave Length:	775-815 nm, 655-666 nm
Laser Power:	No hazardous radiation is emitted with the safety protection

Note

Mass and dimensions shown are approximate.
Specifications are subject to change without notice.

This product incorporates copyright protection technology that is protected by method claims of certain U.S. patents and other intellectual property rights owned by Macrovision Corporation and other rights owners. Use of this copyright protection technology must be authorized by Macrovision Corporation, and is intended for home and other limited viewing uses only unless otherwise authorized by Macrovision Corporation. Reverse engineering or disassembly is prohibited.

Index

A		
Audio	16	
Auto Setup	12, 57	
C		
Chasing play	21	
Clock	56	
Connecting	10, 47, 53	
Country	12, 58	
CREATE PLAY LIST	38	
D		
DIRECT NAVIGATOR	33, 61	
Disc	8, 13, 19, 60	
DISC INFORMATION	29	
Dolby Digital	9, 46, 54, 61	
DTS	9, 46, 54, 61	
E		
Erase	13, 34	
F		
Finalize	32, 61	
Flexible recording mode	20	
Format	31	
Frame-by-frame	14	
FUNCTIONS window	22	
G		
G-CODE	24	
L		
Language	43	
M		
Manual tuning	56	
Marker	17	
MENU	13	
MP3	18	
MPEG	54	
P		
PLAY	13	
PLAY LIST	37, 61	
Progressive	48, 53, 61	
Q		
Quick View (Play ×1.3)	14	
R		
Ratings	51, 54	
Recording	19, 28	
Recording modes	19	
Remaining time	20	
Repeat play	45	
RESUME PLAY	14	
S		
Search	14	
SETUP	50	
Simultaneous recording and play	21	
Slow-motion	14	
Subtitle	43, 51	
T		
Time Slip	15, 22	
Timer recording	24	
Title	29, 34, 42, 62	
W		
Watching the television while recording	22	
Write protect tab	64	

Free Manuals Download Website

<http://myh66.com>

<http://usermanuals.us>

<http://www.somanuals.com>

<http://www.4manuals.cc>

<http://www.manual-lib.com>

<http://www.404manual.com>

<http://www.luxmanual.com>

<http://aubethermostatmanual.com>

Golf course search by state

<http://golfingnear.com>

Email search by domain

<http://emailbydomain.com>

Auto manuals search

<http://auto.somanuals.com>

TV manuals search

<http://tv.somanuals.com>