

Read these operating instructions carefully before using the unit. Follow the safety instructions on the unit and the applicable safety instructions listed below. Keep these operating instructions handy for future reference.

- 1) Read these instructions.
- 2) Keep these instructions.
- 3) Heed all warnings.
- 4) Follow all instructions.
- 5) Do not use this apparatus near water.
- 6) Clean only with dry cloth.
- 7) Do not block any ventilation openings. Install in accordance with the manufacturer's instructions.
- 8) Do not install near any heat sources such as radiators, heat registers, stoves, or other apparatus (including amplifiers) that produce heat.
- 9) Do not defeat the safety purpose of the polarized or grounding-type plug. A polarized plug has two blades with one wider than the other. A grounding-type plug has two blades and a third grounding prong. The wide blade or the third prong are provided for your safety. If the provided plug does not fit into your outlet, consult your electrician for replacement of the outlet. Do not use any other plug.

Getting started

IMPORTANT SAFETY INSTRUCTIONS	2
Useful features	3
Accessories	4
The remote control	4
Control reference guide	5
STEP 1 Connection	6
STEP 2 Setting up the TV Guide On Screen™ system	10
STEP 3 Set up to match your television and remote control	12
HDD, disc and card information	14

Recording

Recording television programs	16
Recording modes and approximate recording times	17
Selecting audio to record	17
Playing while you are recording	18
Flexible Recording	18
Timer recording	19
Using the TV Guide On Screen™ system to make timer recordings	19
Manually programming timer recordings	20
Using VCR Plus+ system to make timer recordings	21
Check, change or delete a program	22
Utilizing TV Guide On Screen™ system	23

Playing back

Playing recorded video contents	
/Playing play-only discs	24
Operations during play	25
Editing operations during play	26
Changing audio during play	26
Using menus to play MP3	27
Playing still pictures	28
Useful functions during still picture play	29
Using on-screen menus and Status messages	30
On-screen menus	30
Status messages	31

Editing

Editing titles/chapters	32
Editing titles/chapters and playing chapters	32
Title operations	33
Chapter operations	33
Creating, editing and playing play lists	34
Creating play lists	34
Editing and playing play lists/chapters	35
Play list operations	35
Chapter operations	35
Editing still pictures	36
Picture and folder operation	36

Useful features

This DVD Video recorder records high quality images to rapid random access capable HDD (Hard disk drive) or DVD-RAM. This has resulted in many new features that out perform older tape formats. The following information summarizes a few of these features.

Instant recording

You no longer need to search for empty disc space. By pressing the recording button, the unit finds available recording space and begins recording right away. There is no need to worry about overwriting already recorded content.

HDD recording

You can keep on recording your favorite programs to an internal HDD that is able to record up to 284 hours when using EP (8H) mode. You can also high speed transfer (dub) your favorite programs to DVD-RAM or DVD-R and create a backup disc.

SD/PC card slots, DV input terminal

This unit is equipped with interfaces that allow networking with digital equipment.

- The SD/PC card slots of this unit let you transfer (dub) digital camera photographs from a card to DVD-RAM for easy storage without using a computer.
- The DV automatic recording function of this unit lets you easily transfer (dub) digital images to the HDD by connecting only a single DV cable.

Transfer (Dubbing)

Transferring (dubbing) titles or play lists	37
One Touch Transfer (dubbing)	38
Transferring (dubbing) using the transferring (dubbing) list	38
Transferring (dubbing) a finalized DVD-R	40
Recording from a video cassette recorder	41
Manual recording	41
DV automatic recording (DV AUTO REC)	41
Transferring (dubbing) still pictures	42
Transferring (dubbing) using the transferring (dubbing) list	42
Transferring (dubbing) all the still pictures on a card —COPY ALL PICTURES	43

Convenient functions

FUNCTIONS window	43
HDD, disc and card setting	44
Setting the protection	44
Providing a disc with a name	44
Erasing all titles and play lists—Erase all titles	44
Erasing all the contents of a disc or card—Format	45
Enabling DVD-R to be played on other equipment—Finalize	45
Entering text	46
Changing the unit's settings	47
Common procedures	47
Summary of settings	47
Channel/Clock settings when TV Guide On Screen™ system is not used	50
Auto channel/clock settings	50
Channel captions	51

Reference

Specifications	52
Glossary	53
Frequently asked questions	54
Error messages	55
Troubleshooting guide	56
Product Service	59
Maintenance/HDD, disc and card handling	60
Limited Warranty	61
<i>Guía de referencia rápida en español</i>	62
<i>(Spanish Quick Reference)</i>	
Index	Backcover

TV Guide On Screen™ system

The TV Guide On Screen™ system provides a handy electronic program guide (EPG) for checking what's on. Setting up to record a broadcast is easy too. Simply select the desired program from the displayed list. You can also search for desired programs alphabetically or by displaying only the programs in a certain category.

- This service may not be available in some areas.

Instant play

There is no need to rewind or search forward. Direct Navigator guides you to the beginning of the recorded video immediately.



Chasing playback

There is no need to wait until recording is complete. Without stopping recording, you can play the video currently being recorded from its beginning.



Simultaneous Recording and Playback

While recording, you can play another video program that was recorded previously.



Time Slip

During play and also while recording, you can jump to the scene you wish to view by specifying the skip time.

Accessories



Please check and identify the supplied accessories. Use numbers indicated in parentheses when asking for replacement parts. **To order accessories, refer to "Accessory Purchases" on page 61.**



1 Remote control
(EUR7721KL0)

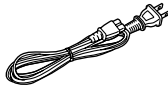

1 AC power supply cord
(K2CB2CB00006)

•For use with this unit only. Do not use it with other equipment.



1 75 Ω coaxial cable
(VJA1125)



2 Batteries
for remote control



1 Audio/video cable
(K2KA6CA00001)



1 IR Blaster
(K2ZZ04C00002)

Product Registration Card

Please complete and return the included product registration card, or register via the Internet at: <http://www.prodreg.com/panasonic/>

The remote control

Batteries

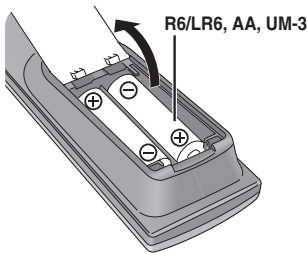

- Insert so the poles (+ and -) match those in the remote control.
- Do not use rechargeable type batteries.
- Do not mix old and new batteries.
- Do not use different types at the same time.
- Do not heat or expose to flame.
- Do not take apart or short circuit.
- Do not attempt to recharge alkaline or manganese batteries.
- Do not use batteries if the covering has been peeled off.

Mishandling of batteries can cause electrolyte leakage which can damage items the fluid contacts and may cause a fire.

Remove if the remote control is not going to be used for a long period of time. Store in a cool, dark place.

Note

If you cannot operate the unit or television using the remote control after changing the batteries, please re-enter the codes (➔ page 12, 13).

Use

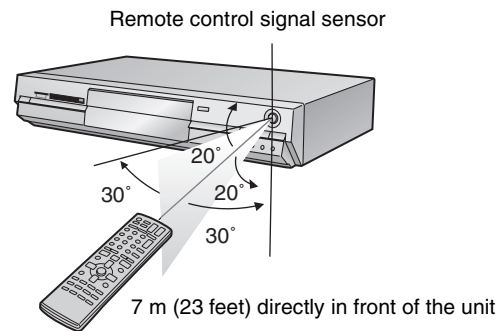

The manufacturer accepts no responsibility and offers no compensation for loss of recorded or edited material due to a problem with the unit or recordable media, and accepts no responsibility and offers no compensation for any subsequent damage caused by such loss.

Examples of causes of such losses are

- A disc recorded and edited with this unit is played in a DVD recorder or computer disc drive manufactured by another company.
- A disc used as described above and then played again in this unit.
- A disc recorded and edited with a DVD recorder or computer disc drive manufactured by another company is played in this unit.

Remote control

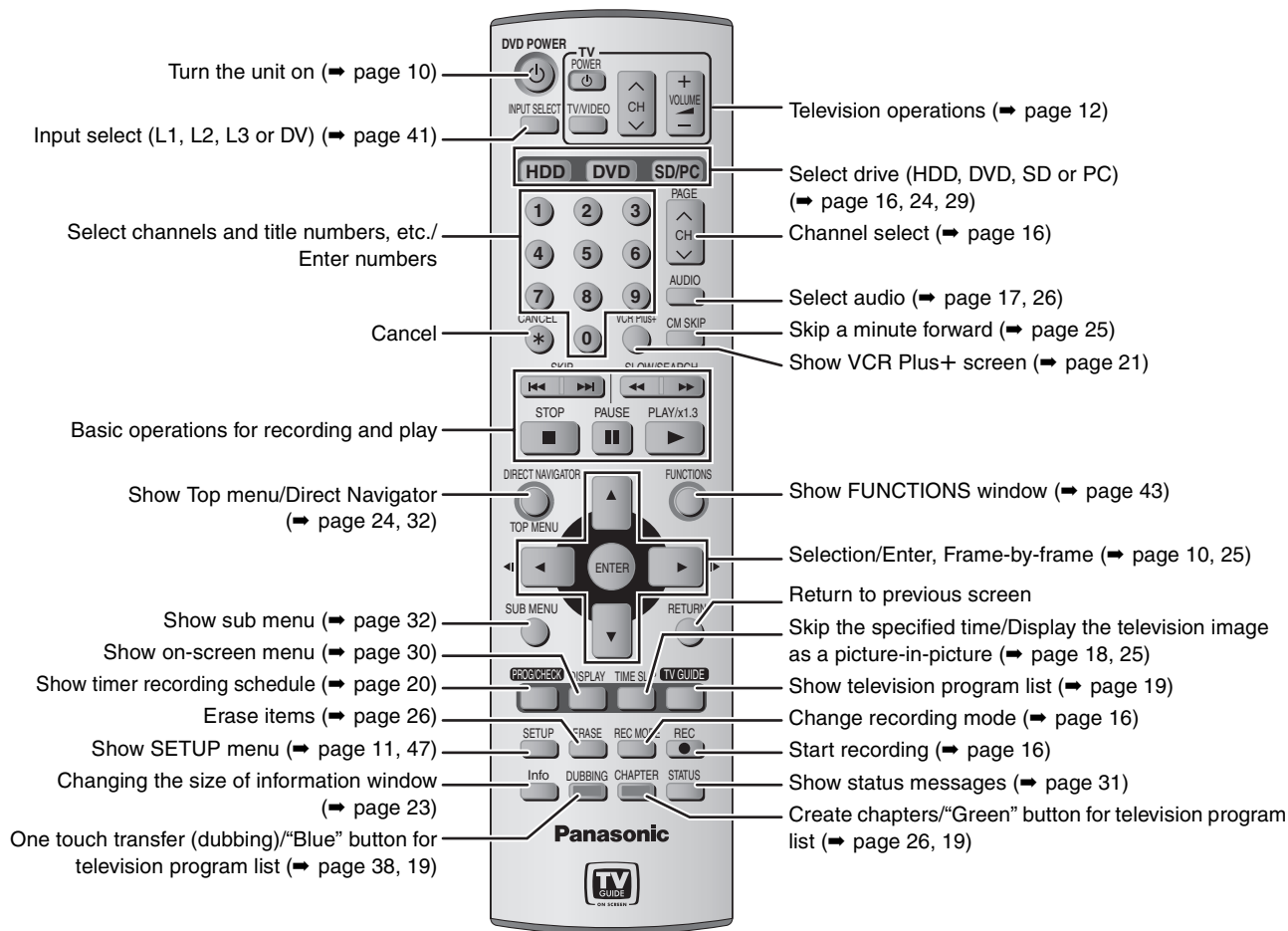

Main unit

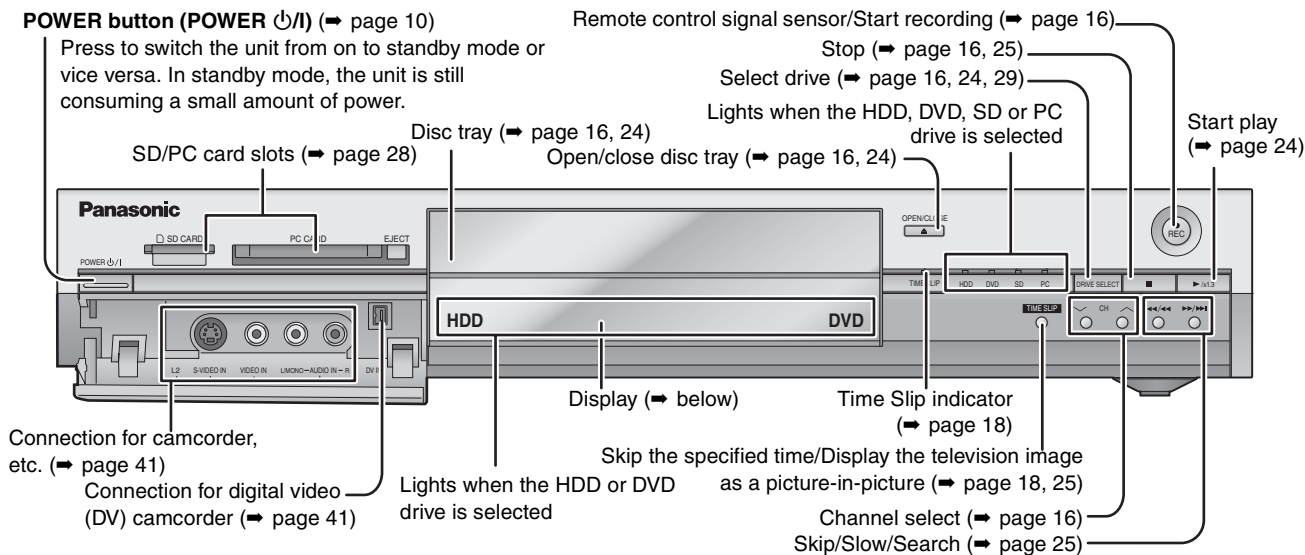

Rear panel terminals (⇒ page 7)

The unit's display

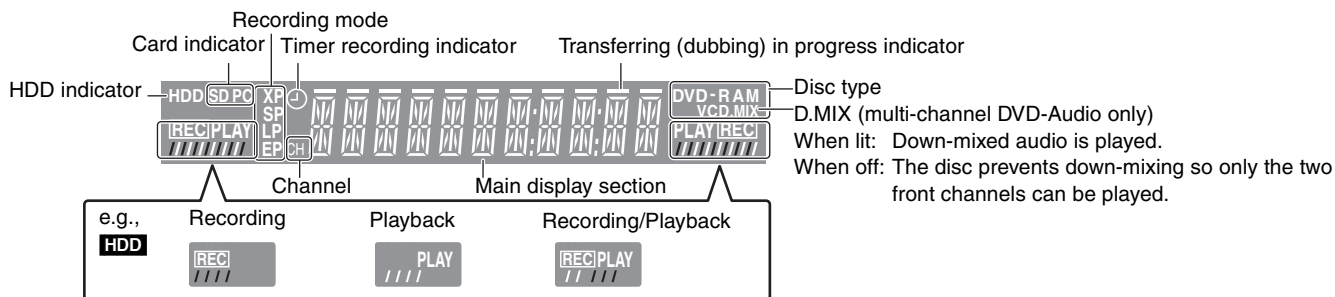

STEP 1 Connection

Examples of equipment you can connect to this unit's terminals

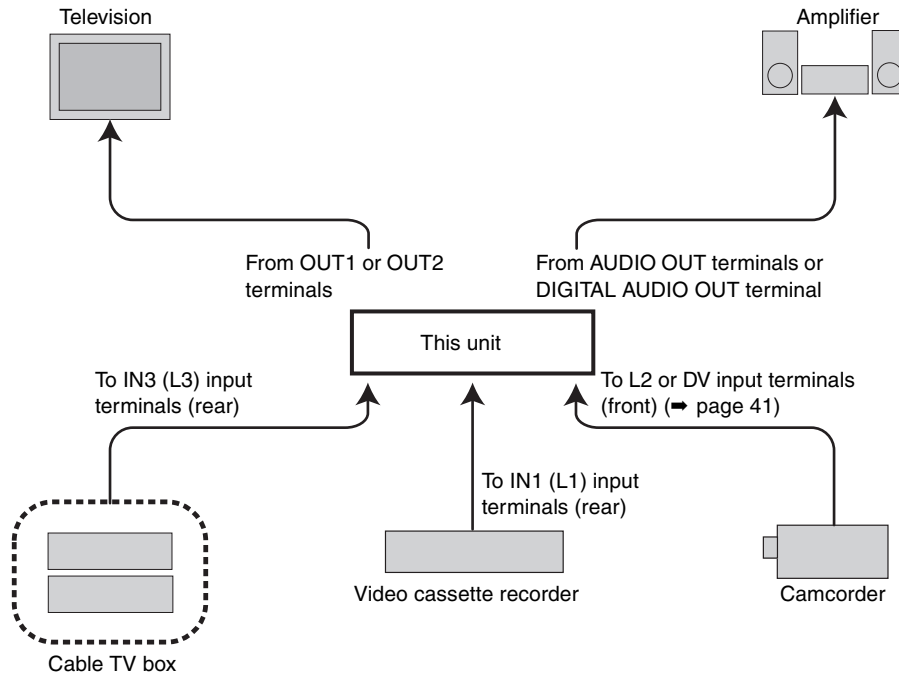

Do not place the unit on amplifiers or equipment that may become hot.

The heat can damage the unit.



When the unit is not to be used for a long time

To save power, unplug it from the household AC outlet. This unit consumes a small amount of power, even when it is turned off (approx. 15 W).

- Note that the television program list is not downloaded while the unit is unplugged.

Before moving the unit, ensure the disc tray is empty.
Failure to do so will risk severely damaging the disc and the unit.



Connecting an amplifier or system component

■ Connection to a stereo amplifier

■ To enjoy multi-channel surround sound on DVD-Video



Connect an amplifier with a built-in decoder displaying these logo marks using an optical digital audio cable and change the settings in "Digital Audio Output" (→ page 49).

- You cannot use DTS Digital Surround decoders not suited to DVD.
- Even if using this connection, output will be only 2 channels when playing DVD-Audio.

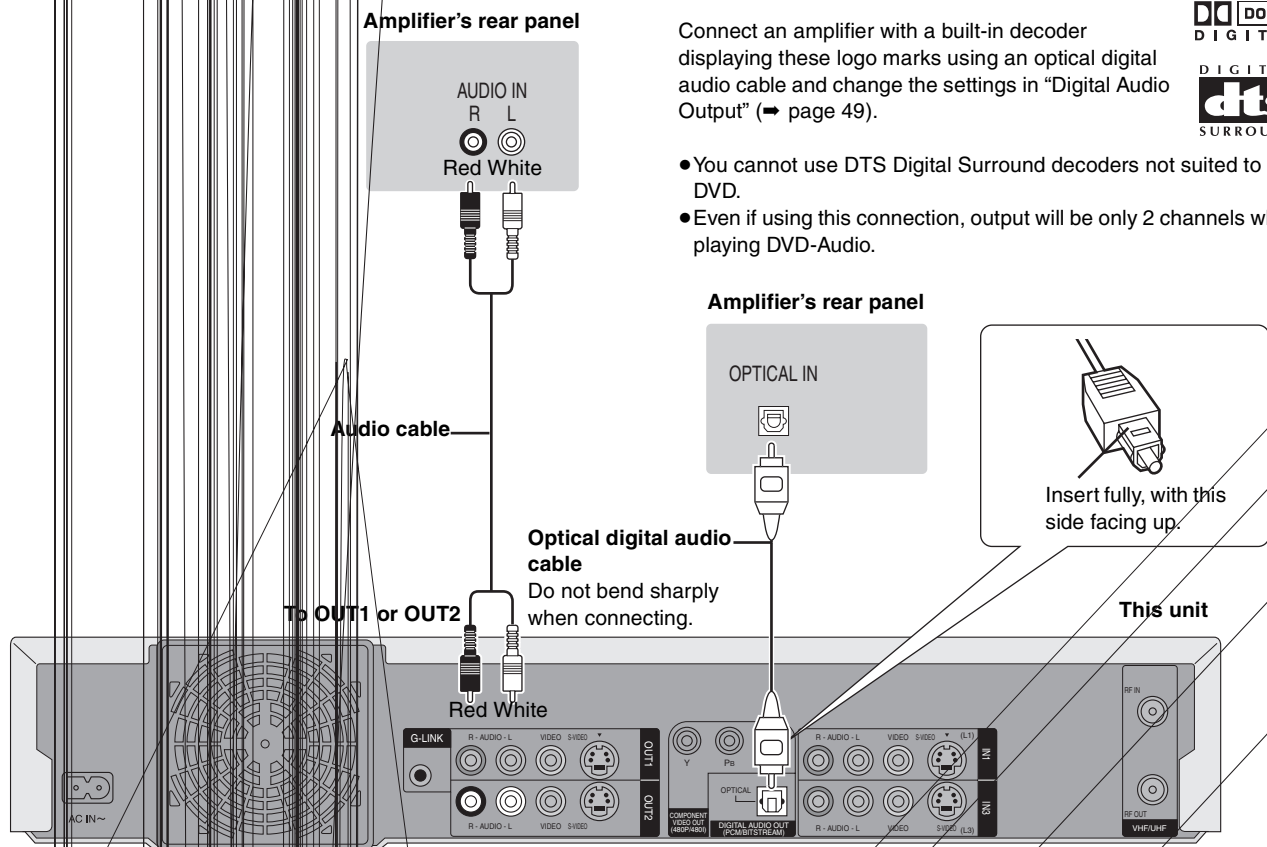

If the antenna connector doesn't match

Other antenna connections to the unit

Use one of the following connections to suit the antenna lead.

- If your television has both lead and coaxial VHF terminals, use the lead connection to minimize signal loss.

■ A single twin lead

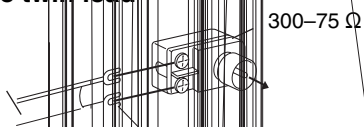

■ A twin lead and a coaxial cable

from the antenna



(Round) 75 Ω coaxial cable

■ Two twin leads

from the antenna

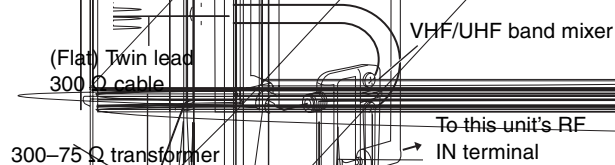

Other antenna connections from the unit to the television

Use one of the following connections to suit the antenna terminals on your television. Refer to the television's operating instructions.

■ A twin lead and coaxial plug terminal



■ A twin lead terminal



■ Two twin lead terminals

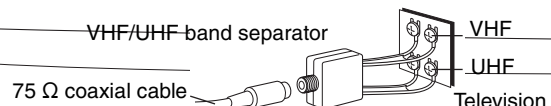

■ Multiple antenna terminals

• Connect to one of the ANT terminals, then change the television's settings as necessary.

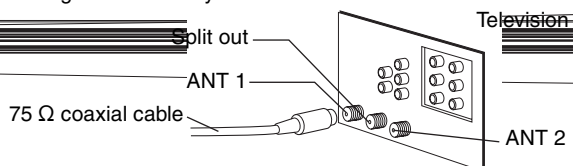

S.
.
reen.

en™ system
nnected.

If you are using a cable TV box, set the following:

- Cable TV box connection channel (Ch2/Ch3/Ch4/L3)
 - If you are connecting the cable TV box to this unit's IN3 (L3) terminal, select "L3".
 - If you are connecting the cable TV box to this unit's RF terminal, select "Ch2", "Ch3" or "Ch4", according to the cable TV box setting.
- Cable TV box brand

(Move down with [▼] for more brands. Select "Not Listed" if you cannot find your cable TV box on the list.)
- IR signal code

Make sure your cable TV box is set to the channel that appears on screen and press [ENTER]. A test is performed.

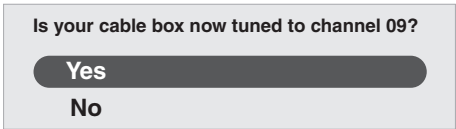

- If the cable TV box has changed to channel 09, select "Yes" and press [ENTER].
- If the cable TV box is still set to the same channel, select "No" and press [ENTER]. Repeat this step until the cable TV box changes to channel 09.

■ The set contents are displayed together

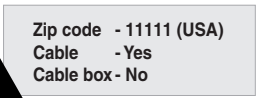

If the information is correct, select "Yes, end setup" and press [ENTER].

If the information is not correct, select "No, repeat setup" and press [ENTER] to start the setting again.

To confirm the input content, the following screen appears.

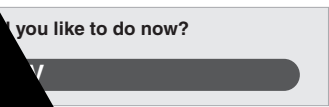

[ENTER].

on screen or a blue background screen is

Use TV Guide On Screen™ system
clock settings

[ENTER].

downloads the television
maximum of 24 hours.

Cable TV box

to download the

downloaded
TV box while the

vision when
the program

Set the clock immediately (Manual Clock Setting)

Set the clock manually.
Please note that the program list is not displayed until the unit
downloads it. Timer program recording is only possible manually.

- 1 Press [SETUP].
- 2 Press [▲, ▼] to select "Set Up" and press [▶].
- 3 Press [▲, ▼] to select "Manual Clock Setting" and press [ENTER].

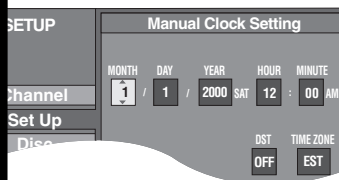

- 4 Press [◀, ▶] to select the item you want to change and press [▲, ▼] to change the setting.
- 5 Press [ENTER].
- 6 Press [SETUP].

- DST (Daylight Saving Time): ON or OFF

If you select "ON", the clock is advanced one hour starting at 2 a.m. on the first Sunday in April and ending at 2 a.m. on the last Sunday in October.
- TIME ZONE shows the time difference from Greenwich mean time (GMT).
 - EST (Eastern Standard Time) = GMT - 5
 - CST (Central Standard Time) = GMT - 6
 - MST (Mountain Standard Time) = GMT - 7
 - PST (Pacific Standard Time) = GMT - 8
 - AST (Alaska Standard Time) = GMT - 9
 - HST (Hawaii Standard Time) = GMT - 10

In the United States, TV GUIDE and other related marks are registered marks of Gemstar-TV Guide International, Inc. and/or one of its affiliates. In Canada, TV GUIDE is a registered mark of Transcontinental Inc., and is used under license by Gemstar-TV Guide International, Inc. TV Guide On Screen, G-LINK, VCR Plus+ and PlusCode are registered marks of Gemstar-TV Guide International and/or one of its affiliates.

The TV Guide On Screen and VCR Plus+ systems are manufactured under license from Gemstar-TV Guide International, Inc. and/or one of its affiliates.

GEMSTAR-TV GUIDE INTERNATIONAL, INC. AND/OR ITS RELATED AFFILIATES ARE NOT IN ANY WAY LIABLE FOR THE ACCURACY OF THE PROGRAM SCHEDULE INFORMATION PROVIDED BY THE TV GUIDE ON SCREEN SYSTEM. IN NO EVENT SHALL GEMSTAR-TV GUIDE INTERNATIONAL, INC. AND/OR ITS RELATED AFFILIATES BE LIABLE FOR ANY AMOUNTS REPRESENTING LOSS OF PROFITS, LOSS OF BUSINESS, OR INDIRECT, SPECIAL, OR CONSEQUENTIAL DAMAGES IN CONNECTION WITH THE PROVISION OR USE OF ANY INFORMATION, EQUIPMENT, OR SERVICES RELATING TO THE TV GUIDE ON SCREEN SYSTEM.

The TV Guide On Screen and VCR Plus+ systems are protected by one or more issued United States patents such as 6,331,877; 6,239,794; 6,154,203; 5,940,073; 4,908,713; 4,751,578; 4,706,121; 6,466,734; 6,430,359; 6,091,813; 5,496,682; 5,335,079; 5,307,172.

STEP 3 Set up to match your television and remote control

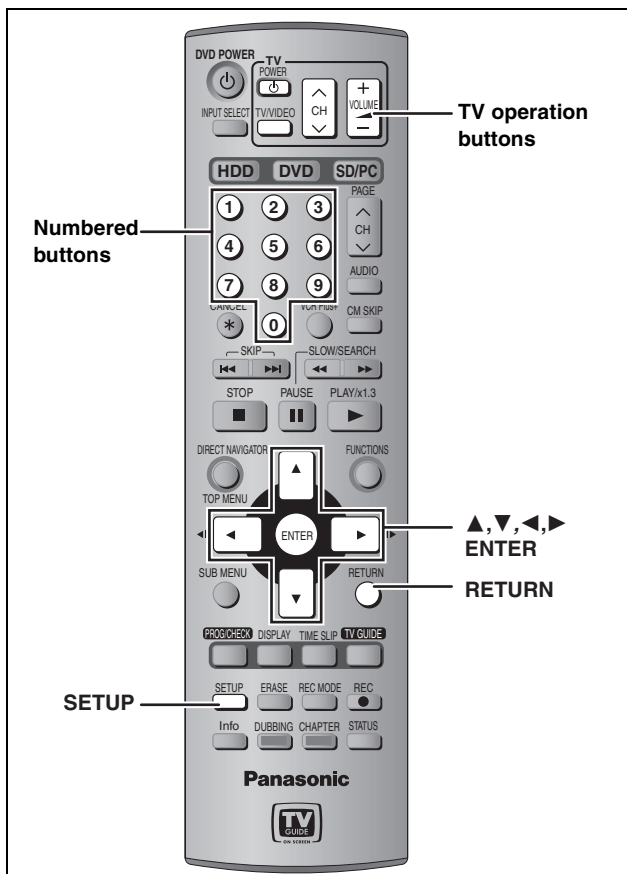

Television operation

You can configure the remote control TV operation buttons to turn the television on/off, change the television input mode, select the television channel and change the television volume.

Point the remote control at the television

While pressing [POWER TV], enter the code with the numbered buttons.

e.g., 01: [0] → [1]

Manufacturer and Code No.

Panasonic		PHILIPS (RC-5)	03
National	01, 02	RCA	05
QUASAR		SAMSUNG	14, 18, 19
FISHER	10	SANYO	10
GE	05	SHARP	06, 07
GOLDSTAR	15, 16, 17	SONY	08
HITACHI	12	SYLVANIA	03
JVC	11	THOMSON	05
LG	15, 16, 17	TOSHIBA	09
MAGNAVOX	03	ZENITH	04
MITSUBISHI	13		

Test by turning on the television and changing channels. Repeat the procedure until you find the code that allows correct operation.

• If your television brand is not listed or if the code listed for your television does not allow control of your television, this remote control is not compatible with your television.

Selecting television type

You do not have to change the setting when connected to a 4:3 standard aspect television that is not compatible with progressive output (→ page 53).

- 1 Press [SETUP].
- 2 Press [▲, ▼] to select "TV Screen" and press [▶].
- 3 Press [▲, ▼] to select "TV Type" and press [ENTER].

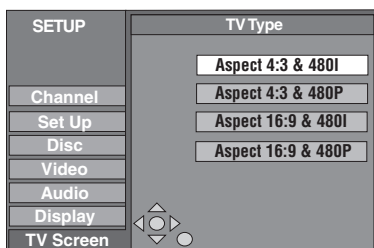

• Aspect 4:3/Aspect 16:9:



4:3 standard aspect television

16:9 widescreen television

• 480P/480i:

Select "480P" if the television is compatible with progressive output.

- 4 Press [▲, ▼] to select the item and press [ENTER].

To exit the screen

Press [SETUP].

To return to the previous screen

Press [RETURN].

When other Panasonic products respond to this remote control

Change the remote control code on the main unit and the remote control (the two must match) if you place other Panasonic products close together.

Use "1", the factory set code, under normal circumstances.

- 1** Press [SETUP].
- 2** Press [▲, ▼] to select "Set Up" and press [▶].
- 3** Press [▲, ▼] to select "Remote Control Code" and press [ENTER].
- 4** Press [▲, ▼] to select the code (1, 2, or 3) and press [ENTER].



- 5** To change the code on the remote control
While pressing [ENTER], press and hold the numbered button ([1], [2] or [3]) for more than 2 seconds.
- 6** Press [ENTER].

- When the following indicator appears on the unit's display



The unit's remote control code

Change the code on the remote control to match the main unit's (→ step 5).

To exit the screen

Press [SETUP].

To return to the previous screen

Press [RETURN].



Cards useable on this unit

	Type	Instructions
SD Memory Card MultiMediaCard	You can insert directly into the SD card slot. SD	<ul style="list-style-type: none"> You can play and transfer (dub) still pictures taken on a digital camera etc. (⇒ page 28, 42). You can set the DPOF (Digital Print Order Format) for automatic printing on your home printer or at a photo developing store (⇒ page 36, 53).
SD Memory Card MultiMediaCard CompactFlash SmartMedia MEMORYSTICK xD-Picture Card Microdrive	You can insert into the PC card slot using an adaptor (TYPE II PC card adaptor). PC	<ul style="list-style-type: none"> Compatible with: FAT 12 or FAT 16 We recommend using a Panasonic SD card. You cannot use SD cards that exceed 2 GB. We recommend using this unit to format a card before recording (⇒ page 45, 53). You may not be able to use the card if formatted on a computer.
ATA Flash PC Card Mobile hard disk*	You can insert directly into the PC card slot. PC	<ul style="list-style-type: none"> * Content saved on SD media storage (SV-PT1). You can only play the recorded still pictures and transfer (dub) the data onto other cards, HDD or DVD-RAM.

Structure of folders displayed by this unit

The following  can be displayed on this unit.

***: Numbers XXX: Letters

Card

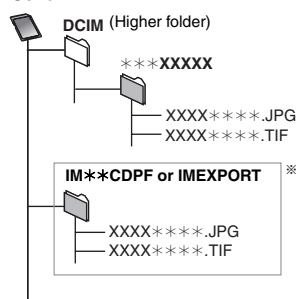

DVD-RAM

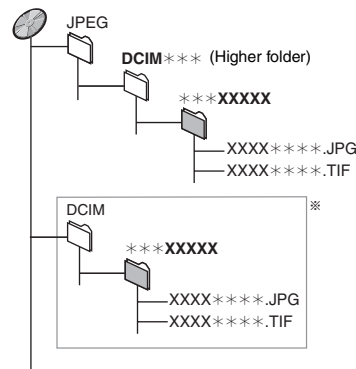

* Folders can be created on other equipment. However, these folders cannot be selected as a transferring (dubbing) destination.

• The folder cannot be displayed if the numbers are all "0" (e.g., DCIM000 etc).

• If a folder name or filename has been input using other equipment, the name may not be displayed properly or you may not be able to play or edit the data.

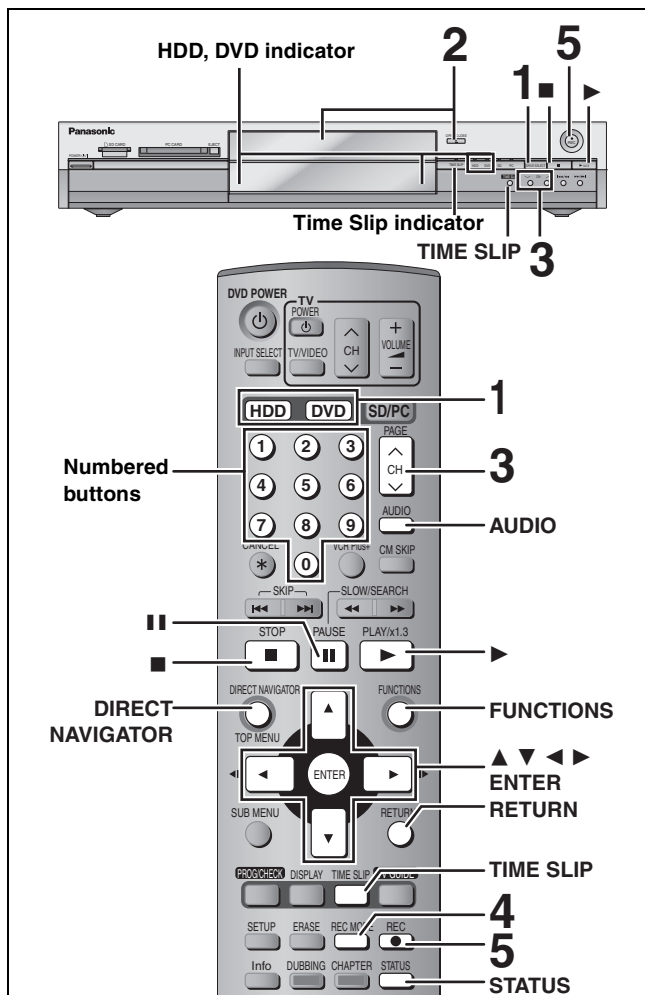

HDD RAM DVD-R

- It is not possible to record to both HDD (Hard Disk Drive) and DVD drive simultaneously.
- You can record up to 500 titles on HDD, 99 titles on one disc.
- It is not possible to record continuously from one side of a double sided disc to the other. You will need to eject the disc and turn it over.
- When using 8 cm (3") DVD-RAM, remove the disc from the cartridge.
- It is not possible to record CPRM (⇒ page 53) protected material onto DVD-R or 2.8 GB DVD-RAM discs.
- It is not possible to record to a card.

When transferring (dubbing) in high speed mode to DVD-R after you have recorded to the HDD.

Set "DVD-R High-Speed Recording" to "On" before recording to the HDD (⇒ page 48).

However, the following restrictions apply.

- Even 16:9 aspect (Widescreen) programs are recorded in 4:3 aspect.
- Even if "Hybrid VBR Resolution" is set to "Automatic", it changes to "Fixed" automatically (⇒ page 48).

When recording to DVD-R

- When recording MTS broadcasts, only the audio selected in "Select MTS" (⇒ page 48) is recorded ("Main" or "SAP").
- In order to play a DVD-R recorded using this unit on another playback source, the disc must first be finalized (⇒ page 45).

Preparation

Press [RETURN] to exit the television program list if it is displayed on the television. To turn off auto start up of the television program list ⇒ page 23, Selecting the TV Guide On Screen™ system start up pattern.

1 Press [HDD] or [DVD] to select the recording drive.

The HDD or DVD indicator lights up on the unit.

2 If you selected the DVD drive Press [▲ OPEN/CLOSE] on the main unit to open the tray and insert a disc.

- Press the button again to close the tray.

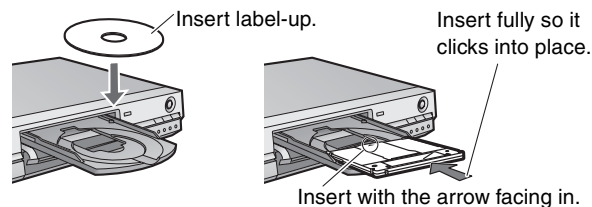

3 Press [▲ ▼ CH] to select the channel.



To select with the numbered buttons:

TV Mode (Airwaves)

e.g., 5: [0] ⇒ [5]
15: [1] ⇒ [5]

CATV Mode (Cable)

e.g., 5: [0] ⇒ [0] ⇒ [5]
15: [0] ⇒ [1] ⇒ [5]
115: [1] ⇒ [1] ⇒ [5]

- Select the audio to record (⇒ page 17).

4 Press [REC MODE] to select the recording mode (XP, SP, LP, or EP).



Remaining time on the disc

- To record sound using LPCM (XP mode only): Set "Audio for XP Recording" to "LPCM" in the SETUP menu (⇒ page 49).

5 Press [● REC] to start recording.



Recording will take place on open space on the HDD or on disc. Data will not be overwritten.

- You cannot change the channel or recording mode during recording.

- You can record while the unit is on standby for timer recording, but once the time for the timer recording to begin is reached, any recording taking place will stop and the timer recording will begin.

To stop recording

Press [■].

From the start to the end of the recording is called one title.

HDD

When continuously recording for long durations, titles are automatically divided every 8 hours.

DVD-R

It takes about 30 seconds for the unit to complete recording management information after recording finishes.

To pause recording

Press [II].

Press again to restart recording.

(Title is not split into separate titles.)

■ To specify a time to stop recording—One Touch Recording

During recording

Press [● REC] to select the recording time.

Each time you press the button:

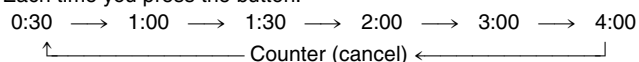

- This does not work during timer recordings (⇒ page 19) or while using Flexible Recording (⇒ page 18).

To stop recording partway

Press [■].

Off Timer

The unit switches to standby after about 6 hours in the stop mode. You can turn this feature off or change the time to 2 hours (⇒ page 47, "Off Timer").

Recording modes and approximate recording times

Depending on the content being recorded, the recording times may become shorter than indicated.

(Unit: hour)

Mode	HDD (160GB)	DVD-RAM		DVD-R (4.7 GB)
		Single-sided (4.7 GB)	Double-sided (9.4 GB)	
XP (High quality)	36	1	2	1
SP (Normal)	70	2	4	2
LP (Long play)	138	4	8	4
EP (Extra long play)	284 (212*)	8 (6*)	16 (12*)	8 (6*)

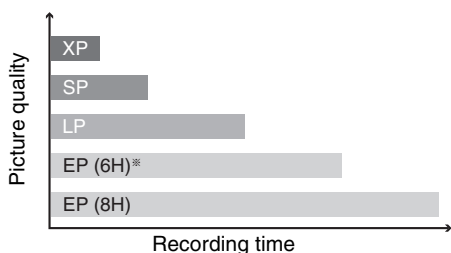

* When "Recording Time in EP Mode" is set to "EP (6H)" in the SETUP menu. The sound quality is better when using "EP (6H)" than when using "EP (8H)".

Note

When recording to DVD-RAM using EP (8H) mode, play may not be possible on DVD players that are compatible with DVD-RAM. In this case use EP (6H) mode.

FR (Flexible Recording Mode)

The unit automatically selects a recording rate between XP and EP (8H) that will enable the recordings to fit in the remaining disc space with the best possible recording quality.

- You can set when transferring (dubbing) or programming timer recordings.
- When recording to the HDD, picture quality is automatically adjusted to precisely fit a transferred (dubbed) title on a 4.7 GB disc.
- All the recording modes from XP to EP appear in the display.



Selecting audio to record

HDD RAM

Press [AUDIO].

- **Stereo:** Main audio (stereo)
 - If the broadcast is "Mono+SAP", audio will be monaural even if you select Stereo mode.
 - ↓
 - SAP:** Secondary audio program (SAP)
 - If recorded in SAP mode, main audio is also recorded.
 - ↓
 - Mono:** Main audio (monaural)
 - Select "Mono" if reception is poor during a stereo broadcast.
- e.g., "Stereo" is selected
 ("(" appears when the unit is receiving the audio type you selected.

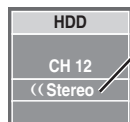

- If you change the sound setting while recording, the recorded sound will also change.

DVD-R

HDD RAM (When recording sound in LPCM)

HDD RAM (When "DVD-R High-Speed Recording" is set to "On")

Select the audio (Main or SAP) in "Select MTS" in the SETUP menu (⇒ page 48).

Refer to the control reference on page 16.

HDD **RAM**

Playing while you are recording

You can change the drive and play while recording on this unit. Also, while recording to the HDD or to DVD-RAM you can view the title being recorded from the beginning as well as play a recorded title.

Playing from the beginning of the title you are recording—Chasing playback

Press [▶] (PLAY).

Time Slip indicator on the main unit lights.

Playing a title previously recorded while recording—Simultaneous rec and play

1 Press [DIRECT NAVIGATOR].

2 Press [▲, ▼, ◀, ▶] to select a title and press [ENTER].

Time Slip indicator on the main unit lights.

To exit the Direct Navigator screen

Press [DIRECT NAVIGATOR].

Reviewing the recorded images while recording—Time Slip

1 Press [TIME SLIP].

Time Slip indicator on the main unit lights.

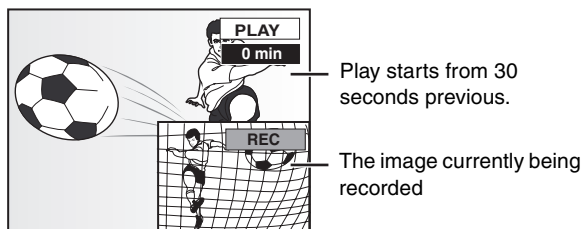

- You will hear the playback audio.

2 Press [▲, ▼] to select the time and press [ENTER].

- Press [TIME SLIP] to show the play images in full. Press again to show the play and recording images.

■ To stop play

Press [■].

■ To stop recording

2 seconds after play stops

Press [■].

■ To stop timer recording

Press [■], then [ENTER] within 5 seconds.

- You can also press and hold [■] on the main unit for more than 3 seconds to stop recording.

HDD **RAM** **DVD-R**

Flexible Recording

The unit sets the best possible picture quality that fits the recording within the remaining disc space. The recording mode becomes FR mode.

e.g.,

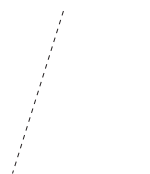

Preparation

- Select the channel to record.
- Press [HDD] or [DVD] to select the recording drive.

1 While stopped Press [FUNCTIONS].

2 Press [▲, ▼, ◀, ▶] to select “FLEXIBLE RECORDING” and press [ENTER].

3 Press [◀, ▶] to select “Hour” and “Min.” and press [▲, ▼] to set the recording time.

- You can also set the recording time with the numbered buttons.
- You cannot record more than 8 hours.

4 When you want to start recording Press [▲, ▼, ◀, ▶] to select “Start” and press [ENTER].

Recording starts.

To exit the screen without recording

Press [RETURN].

To stop recording partway

Press [■].

To show the remaining time

Press [STATUS].

ered

ING]

no)

NTF

2 Press [CHAP

3 Enter the sett

To enter the date

Entering PlusCode®

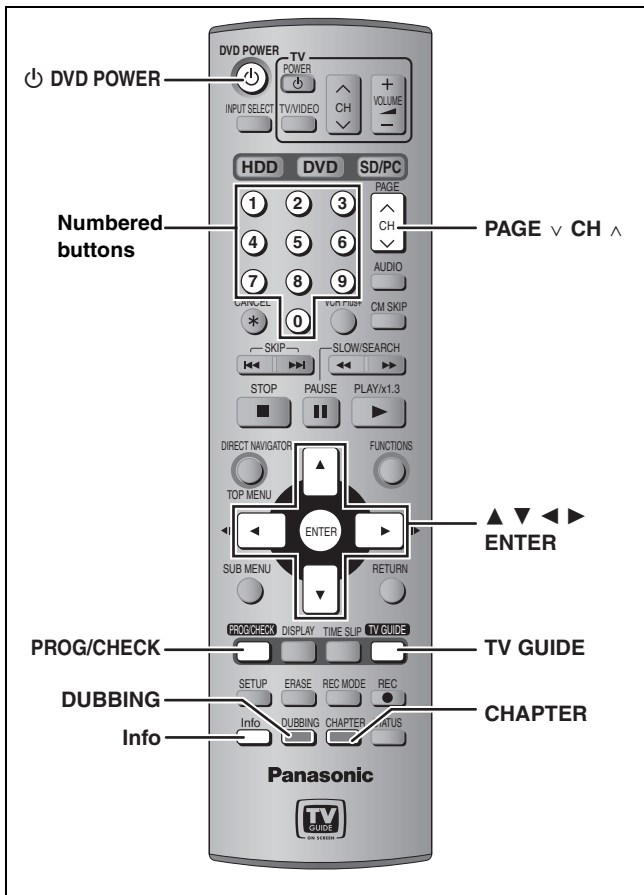

Check, change or delete a program

■ **To change the recording frequency**

Press [CHAPTER] (Green).

■ **To change the time, recording mode and recording drive**

Press [ENTER]. (→ page 19, To change the setting, step ④)

■ **To delete the program**

Press [DUBBING] (Blue).

■ **To exit the screen**

Press [TV GUIDE].

Returns to the television screen.

•The unit is not off. To save power, turn the unit off by pressing [DVD POWER].

■ **When there is a duplicate or overlapping program timer recording**

The program timer recording that was set last is recorded. None of the program that was set earlier is recorded even if there is only partial overlapping.

Program timer recordings that are not recorded are highlighted in grey.

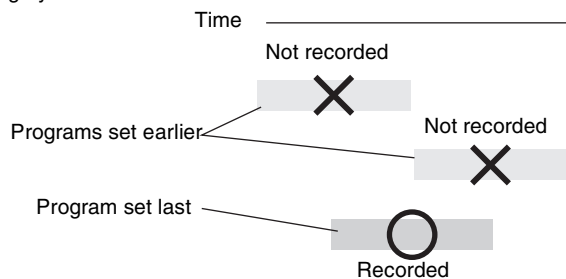

1 Press [PROG/CHECK].

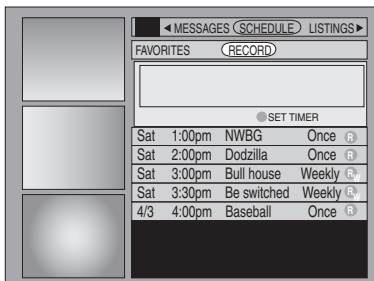

2 Press [▲, ▼] to select the program.

Channel or program name (a program name that was set for timer recording using TV Guide On Screen™ system or VCR Plus+ system that was listed in the program list)

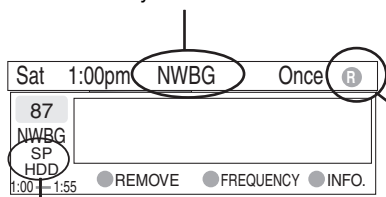

Recording mode (→ page 17) Frequency (→ page 19, 20)
Recording drive

Press [TV GUIDE].

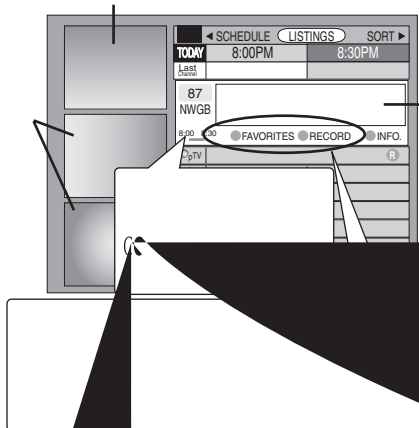

Programs are categorized by color.

- Green: Sports
- Blue: Children's
- Purple: Movies
- Teal: Other categories

Selecting a program from the desired program category and setting timer recording

- 1 Press [▲] several times to select "LISTINGS".
- 2 Press [◀, ▶] to select "SORT" and press [▼].
- 3 Press [▲, ▼] to select the major category and press [▼].
- 4 Press [◀, ▶] to select the minor category and press [ENTER].
- 5 Press [▲, ▼] to select.
 - Press [ENTER] and [▲, ▼] to scroll alphabetically.
- 6 Press [CHAPTER] (Green).

Changing the size of information window

When a program is highlighted.

Changing the channel line-up

The channel list's channel line-up differs from what you see on the TV from the following steps.

- 1 Press [▲] several times to select "LISTINGS".
- 2 Press [◀, ▶] to select "SETUP" and press [▼].
- 3 Press [▲, ▼] to select "Change system settings" and press [ENTER].
- 4 Press [▲, ▼] to select "Yes, but my channel line-up is incorrect".

If you have more than one cable network transmitting television programs in your area where you are living, more than one program may be displayed. Press [▲, ▼] to select one and then press [ENTER].

You can customize the channel line-up in the Channel Line-Up menu (during the channel line-up). Press [▲, ▼] to select a channel and then press [ENTER].

Utilizing TV Guide On Screen™ system

- 1 Press [▲] several times to select "LISTINGS".
- 2 Press [◀, ▶] to select "PROMOTIONS" and press [▼].
- 3 Press [▲, ▼] to select "Messages" and press [ENTER].
- 4 Press [ENTER] to delete unwanted messages.

When you are viewing new TV Guide On Screen™ messages, a special envelope-shaped icon appears at the end of the list.

- 1 Press [▲] several times to select "LISTINGS".
- 2 Press [◀, ▶] to select "MESSAGES" and press [▼].
- 3 Press [▲, ▼] to select the message and press [Info].
- 4 Press [CHAPTER] (Green) to delete unwanted messages. Messages are automatically deleted after 60 days.
- 5 The ID number appears at the end of the list.

Customizing the channel line-up

- 1 Press [▲] several times to select "LISTINGS".
- 2 Press [◀, ▶] to select "SETUP" and press [▼].
- 3 Press [▲, ▼] to select "Change channel display" and press [ENTER].
- 4 Press [▲, ▼] to select the channel.
 - Press [PAGE ∨ CH ▲] to skip one screen.

To hide the channel

Press [CHAPTER] (Green) to select "OFF".

To change the order of the channels

- 1 Press [▲] several times to move up or [CHAPTER] (Green) to move down.
- 2 Press [1] → [1] → [5].
- 3 Press [1] → [1] → [5].

Registering a program you don't want to miss as a "Favorite"

By registering a program as "Favorite" in advance, you can later tune to that program quickly by pressing [DUBBING] (Blue) when that program begins broadcasting.

When you cannot remember the television program you want to watch, we recommend you press [DUBBING] (Blue) when the television reception screen is displayed. This unit may tune in your "Favorite" program.

- 1 Press [TV GUIDE].
- 2 Press [▲, ▼, ◀, ▶] to select the program.
- 3 Press [DUBBING] (Blue).

"F" appears in the list to indicate that the program is set as a "Favorite".

- Press [CHAPTER] (Green) to change the frequency. Each time you press the button:

- Press [DUBBING] (Blue) to cancel. Repeat steps 2–3 to set other programs.

When there is more than one program registered as "Favorite" in the same time frame, each time you press [DUBBING] (Blue), the program switches to the other.

Viewing TV Guide On Screen™ system explanations and promotions

- 1 Press [▲] several times to select "LISTINGS".
- 2 Press [◀, ▶] to select "PROMOTIONS" and press [▼].
- 3 Press [▲, ▼] to select and press [ENTER].

Recording

Playing recorded video contents/Playing play-only discs

Playing back

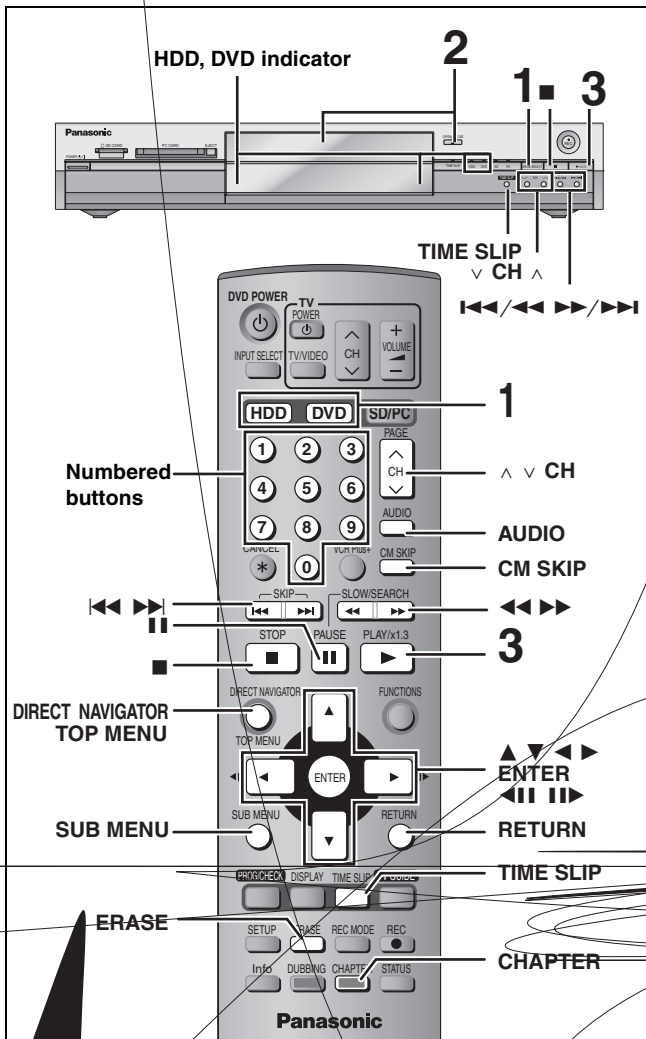

3 Press [▶] (PLAY).

HDD RAM DVD-R

Play starts from the most recent recorded title.

DVD-A DVD-V VCD CD

Play starts from the beginning.

■ Selecting recorded programs Direct Navigator

HDD RAM DVD-R

1 Press [DIRECT NAVIGATOR]

Switching the Direct Navigator appearance

- ① Press [SUB MENU] while Thumbnail
 - ② Press [▲, ▼] to select "Table Display"
- The display appearance last used is saved.
 - The display appearance is automatically turned off.

2 Press [▲, ▼, ◀, ▶] to select "VIDEO" tab and press [ENTER]

3 Press [▲, ▼, ◀, ▶] to select the title and press [▶]

You can also select titles with [▶] (SKIP).

It is possible to watch playback from one drive while recording from another (editing is not possible).

It is not possible to play continuously from one side of a double-sided disc to the other. You will need to eject the disc and turn it over.

When using 8 cm (3") DVD-RAM, remove the disc from the tray.

Attention

Press [RETURN] to exit the television program list if it is displayed on the television. To turn off auto start up of the television program list, refer to page 23, Selecting the TV Guide On Screen™ system start up.

Press [HDD] or [DVD] to select playback drive.

The HDD or DVD indicator will light up.

When you selected the DVD drive,

Press [▲] or [▼] to select the title.

Press [▶] to open the title.

Press the button.

To show other pages

Press [▲, ▼, ◀, ▶] to select "Previous" or "Next" and press [ENTER].

- You can also press [◀, ▶] to show other pages.

To exit the screen

Press [DIRECT NAVIGATOR].

To show Direct Navigator screen icons



Press [MENU] or [SUB MENU]. Press [RETURN].

Stop

Press [■].

The stopped position is memorized.
“PLAY” flashes in the unit’s display. (Excluding when playing from the Direct Navigator and when playing a play list.)

Resume play function

Press [▶] (PLAY) to restart from this position.

Pause

Press [⏸].

Press again to restart play.

Search

Press [◀◀] or [▶▶].

- On the main unit, press and hold [◀◀/◀◀] or [▶▶/▶▶].
- The speed increases up to 5 steps.
- Press [▶] (PLAY) to restart play.
- Audio is heard during first level search forward.

You can turn off the sound during search (⇒ page 48, “Search Audio & PLAY × 1.3”).

Audio is heard during all levels of search. **DVD-A** (excluding moving picture parts) **CD**

Skip

Press [◀◀] or [▶▶].

- On the main unit, press [◀◀/◀◀] or [▶▶/▶▶].
- Each press increases the number of skips.

Press the numbered buttons.

e.g., 5: [0] ⇒ [5] **HDD** **CD** (MP3 discs only) 5: [0] ⇒ [0] ⇒ [5]
15: [1] ⇒ [5] 15: [0] ⇒ [1] ⇒ [5]

DVD-A Selecting groups

While stopped (screen saver is displayed on the television ⇒ right)

5: [5]

- This works only when stopped (screen saver is displayed on the television ⇒ right) with some discs.

Starting from a selected item

Quick View

HDD **RAM**

The play speed can be increased without distorting the audio.

Slow-motion

HDD **RAM** **DVD-R** **DVD-A** (Motion picture parts only) **DVD-V** **VCD**

Frame-by-frame

HDD **RAM** **DVD-R** **DVD-A** (Motion picture parts only) **DVD-V** **VCD**

Press and hold [▶] (PLAY/× 1.3).

- Press again to return to normal speed.
- This does not work if the setting is “Off” in “Search Audio & PLAY × 1.3” (⇒ page 48).

While paused, press [◀◀] or [▶▶].

- On the main unit, press and hold [◀◀/◀◀] or [▶▶/▶▶].
- The speed increases up to 5 steps.
- Press [▶] (PLAY) to restart play.
- Forward direction only. **VCD**
- The unit will pause if slow-motion play is continued for 5 minutes.

While paused, press [◀||] or [||▶].

-

Refer to the control reference on page 24.

Editing operations during play

Erase

HDD RAM DVD-R

- 1 Press [ERASE].
- 2 Press [◀, ▶] to select "Erase" and press [ENTER].

- A title cannot be restored once it is erased. Make certain before proceeding.
- You cannot erase while recording or transferring (dubbing).

Create chapters

(⇒ page 32, Title/Chapter)

HDD RAM

Press [CHAPTER].

- Press [◀◀, ▶▶] to skip to the start of a chapter.
- You cannot divide while recording or transferring (dubbing).

Changing audio during play

Press [AUDIO].

HDD RAM VCD

LR→L→R
↑

e.g., "L R" is selected

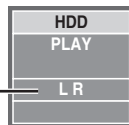

- When playing an SAP broadcast recorded on DVD-RAM: MAIN ↔ SAP

DVD-A DVD-V

You can change the audio channel number each time you press the button. This allows you to change things like the soundtrack language (⇒ page 30, Sound track).



e.g., English is selected.

Note

You cannot change the audio type in the following cases.

- When a DVD-R disc is in the disc tray while DVD drive is selected.
- When the recording mode is XP and "Audio for XP Recording" is set to "LPCM" (⇒ page 49).
- When "DVD-R High-Speed Recording" is set to "On" (⇒ page 48).

[D], [DVD] or [SD/PC] to
drive.

Press [SD/PC]:
→ PC card drive
press
] several times.
ts up on the unit.

e.g., SD card drive



[SELECT NAVIGATOR].



[7], [◀], [▶] to select
tab and press [ENTER].

[7], [◀], [▶] to select the still
press [ENTER].

at still pictures with the numbered buttons.

[0] → [5] 115: [0] → [1] → [1] → [5]
[1] → [5] 1115: [1] → [1] → [1] → [5]

display the previous or next still picture.
during still picture play (⇒ below).

■ **To show the picture properties**
Press [STATUS] twice.

To exit the picture properties screen
Press [STATUS].

Note

Still pictures cannot be played during recording.

IGATOR].

[D] [PC]

Playing back

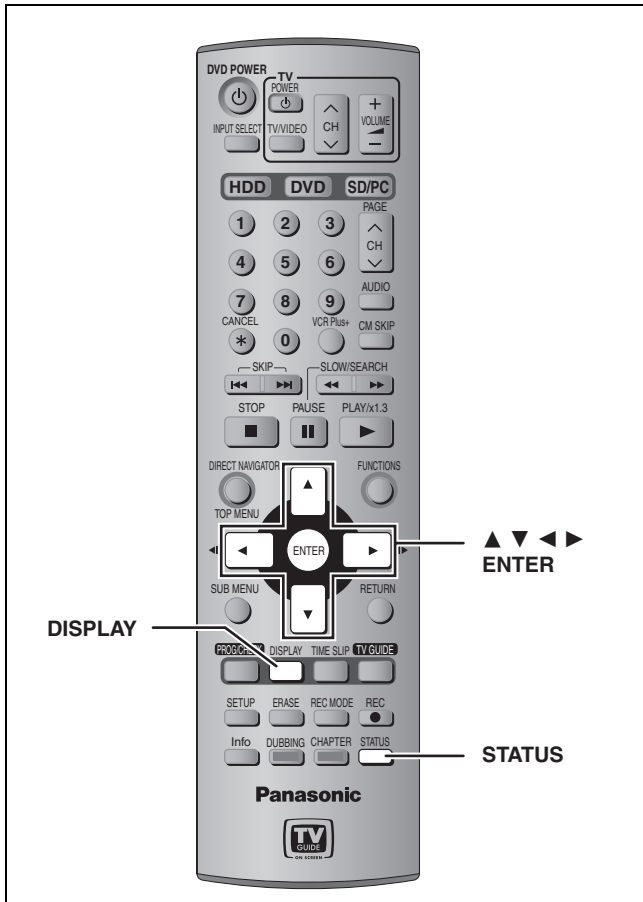

Disc menu—Setting the disc content

Sound track*

HDD RAM DVD-R

The disc's audio attributes appear.

DVD-A DVD-V

Select the audio and language (⇨ below, Audio attribute, Language).

Subtitle*

HDD RAM DVD-R (Only discs that contain subtitle on/off information)

DVD-A DVD-V

Turn the subtitle on/off and select the language (⇨ below, Language).

- Subtitle on/off information cannot be recorded using this unit. **HDD RAM DVD-R**
- If the subtitles overlap closed captions recorded on discs, turn the subtitles off.

Audio channel **HDD RAM VCD**

⇨ page 26, Changing audio during play

Angle* **DVD-A DVD-V**

STILL-P (Still picture) **DVD-A**

Selects the play method for still pictures.

Slide Show: Plays according to the default order on the disc.

Page: Select the still picture number and play.

• **RANDOM:** Plays in random order.

• **Return:** Returns to the default still picture on the disc.

PBC (Playback control ⇨ page 53) **VCD**

Indicates whether menu play (playback control) is on or off.

* You may have to use the menus (⇨ page 24) on the disc to make changes.

• The display changes according to the disc content. You cannot change when there is no recording.

Audio attribute

LPCM/PPCM/□□Digital/DTS/MPEG: Signal type

k (kHz): Sampling frequency

b (bit): Number of bits

ch (channel): Number of channels

Language

ENG: English

SVE: Swedish

CHI: Chinese

FRA: French

NOR: Norwegian

KOR: Korean

DEU: German

DAN: Danish

MAL: Malay

ITA: Italian

POR: Portuguese

VIE: Vietnamese

ESP: Spanish

RUS: Russian

THA: Thai

NLD: Dutch

JPN: Japanese

*: Others

On-screen menus

1 Press [DISPLAY].

Disc	Sound track	1	DQ Digital	2/0 ch
Play	Subtitle	OFF		
Video	Audio channel	L R		

Menu Item Setting

- Depending on the condition of the unit (playing, stopped, etc.) and disc contents, there are some items that you cannot select or change.

2 Press [▲, ▼] to select the menu and press [▶].

3 Press [▲, ▼] to select the item and press [▶].

4 Press [▲, ▼] to select the setting.

- Some items can be changed by pressing [ENTER].

To clear the on-screen menus

Press [DISPLAY].

Play menu—Change the play sequence

This function works only when the elapsed play time is displayed.

Repeat play

- All **VCD CD** (excluding MP3 discs)
 - Chapter **HDD RAM DVD-R DVD-V**
 - Group **DVD-A CD** (MP3 discs only)
 - PL (Play list) **HDD RAM**
 - Title **HDD RAM DVD-R DVD-V**
 - Track **DVD-A VCD CD**
- Select "OFF" to cancel.

Video menu—Change the picture quality

Picture

- **Normal:** Default setting
- **Soft:** Soft picture with fewer video artifacts
- **Fine:** Details are sharper
- **Cinema:** Mellows movies, enhances detail in dark scenes.
- **User:** You can make further adjustments.
Press [**▲**, **▼**, **◀**, **▶**] to select "Detail picture adjustment" and press [ENTER].

Contrast

Increases the contrast between light and dark parts of the picture.

Brightness

Brightens the picture.

Sharpness

Adjust the sharpness of the edges of the horizontal lines.

Color

Adjusts the shade of the picture's color.

Gamma

Increases the brightness of the center ranges to improve detail and contrast in dark scenes.

3D NR

Reduces overall noise.

Integrated DNR

Reduces mosaic noise and character smudging.

MPEG-DNR (When any item other than "User" is selected)

You can turn the recommended settings for 3D NR and Integrated DNR on and off.

Progressive* (⇒ page 53)

Select "ON" to enable progressive output.

- Select "OFF" if the picture is stretched horizontally.
- When progressive output is on, closed captions cannot be displayed.

Transfer* [When "Progressive" (⇒ above) is set to "ON".]

Select the method of conversion for progressive output to suit the type of material being played (⇒ page 53, Film and video).

- **Auto1 (normal):**
Detects 24 frame-per-second film content and appropriately converts it.
- **Auto2:** Compatible with 30 frame-per-second film content in addition to 24 frame-per-second film content. (Picture distortion may occur depending on the content)
- **Video:** Select when using "Auto1" and "Auto2", and the video content is distorted.

Audio menu—Change the sound effect

V.S.S. **HDD RAM DVD-R DVD-V**
(Dolby Digital, 2-channel or over only)

Enjoy a surround-like effect if you are using two front speakers only.

- Turn V.S.S. off if it causes distortion.
- V.S.S. does not work for SAP recordings.

Dialog Enhancer **DVD-A DVD-V**
(Dolby Digital, 3-channel or over only, including a center channel)

The volume of the center channel is raised to make dialog easier to hear.

Status messages

Status messages appear on the television during operation to show the condition of the unit.

Press [STATUS].

The display changes each time you press the button.

- Displayed information are examples.

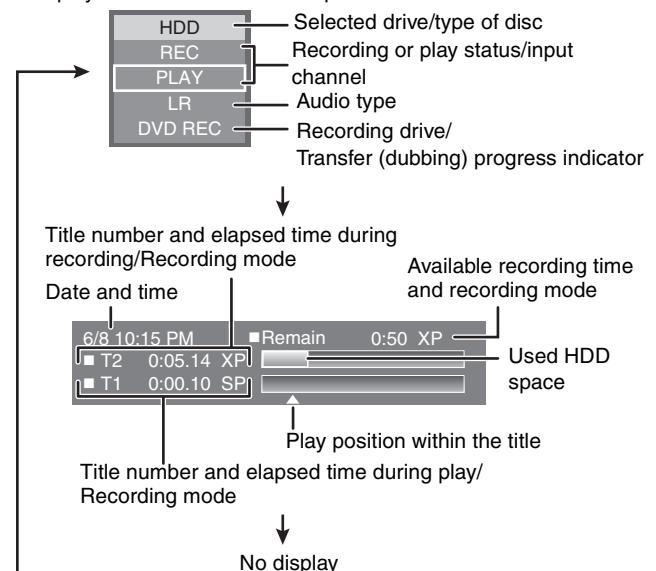

* Only when you have selected "480P" in "TV Type" (⇒ page 12).

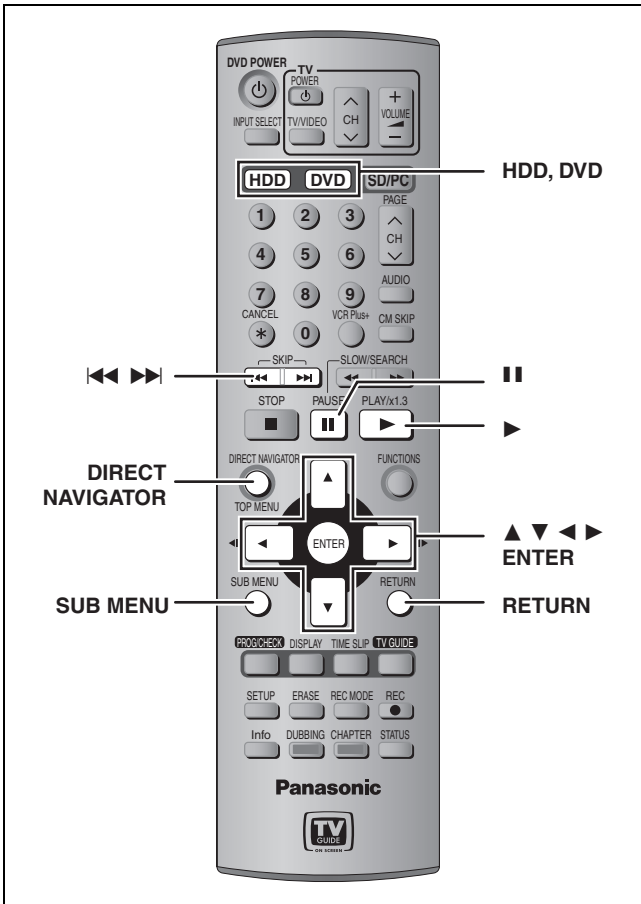

Editing titles/chapters and playing chapters

Preparation

- Press [HDD] or [DVD] to select the drive.
- Release protection (⇒ page 44). **RAM**

- 1 Press [DIRECT NAVIGATOR].
- 2 Press [▲, ▼, ◀, ▶] to select “VIDEO” tab and press [ENTER].
- 3 Press [▲, ▼, ◀, ▶] to select the title.

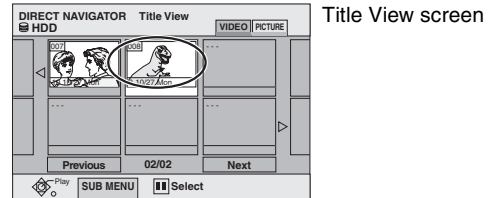

To show other pages

Press [▲, ▼, ◀, ▶] to select “Previous” or “Next” and press [ENTER].

- You can also press [◀◀, ▶▶] to show other pages.

Multiple editing

Select with [▲, ▼, ◀, ▶] and press [■]. (Repeat.) A check mark appears. Press [■] again to cancel.

- 4 Press [SUB MENU], then [▲, ▼] to select the operation and press [ENTER].

- If you select “Edit”, press [▲, ▼] to select the operation and press [ENTER].

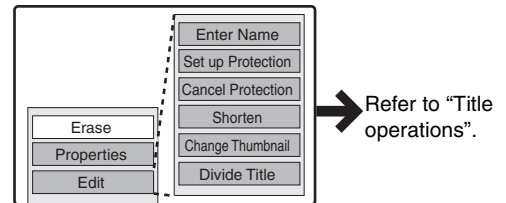

Refer to “Title operations”.

Chapter View → page 24, Switching the Direct Navigator appearance

If you select “Chapter View”

- 5 Press [▲, ▼, ◀, ▶] to select the chapter.

To start play ⇒ Press [ENTER].

To edit ⇒ Step 6.

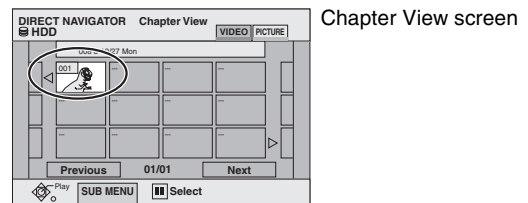

- To show other pages/Multiple editing (⇒ above)

- 6 Press [SUB MENU], then [▲, ▼] to select the operation and press [ENTER].

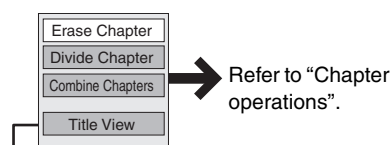

- You can go back to the Title View.

To exit the screen

Press [DIRECT NAVIGATOR].

To return to the previous screen

Press [RETURN].

HDD | RAM | DVD-R

Title/Chapter

Programs are recorded as a single title consisting of one chapter.

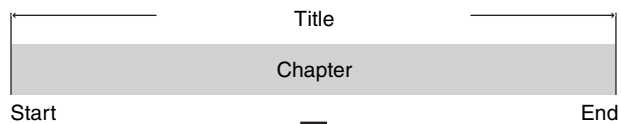

You can divide a title into multiple chapters. **HDD | RAM**
 (⇒ page 26, Create chapters, ⇒ page 33, Divide Chapter)



You can change the order of chapters and create a play list
 (⇒ page 34). **HDD | RAM**

- Titles are divided into about 5-minute chapters after finalizing (⇒ page 45). **DVD-R**

- The maximum number of items on a disc

HDD
 –Titles: 500
 –Chapters: Approximately 1000 per title
 (Depends on the state of recording.)

RAM | DVD-R
 –Titles: 99
 –Chapters: Approximately 1000
 (Depends on the state of recording.)

Note

- Once erased, divided or shortened, it cannot be restored to its original state. Make certain before proceeding.
- You cannot edit during recording, chasing play or transferring (dubbing), etc.
- Restricted recording information remains even after editing (e.g. dividing a title, etc).

Title operations

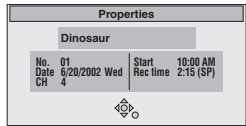
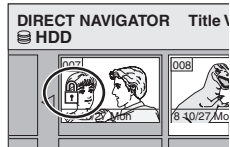
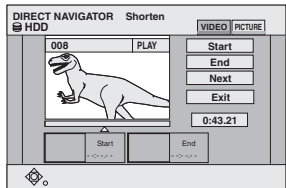
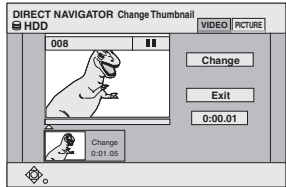
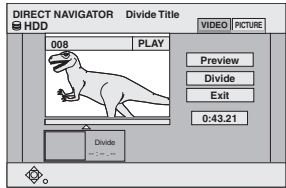
Erase* HDD RAM DVD-R	<p>Press [◀, ▶] to select “Erase” and press [ENTER].</p> <ul style="list-style-type: none"> •Once erased, the recorded contents are lost and cannot be restored. Make certain before proceeding. •The available recording time on DVD-R does not increase when you erase titles.
Properties HDD RAM DVD-R	<p>Information (e.g., time and date) is shown.</p> 
Enter Name HDD RAM DVD-R	<p>You can give names to recorded titles. ➔ page 46, Entering text</p>
Set up Protection* Cancel Protection* HDD RAM	<p>If set, this will protect the title from accidental erasure.</p> <p>Press [◀, ▶] to select “Yes” and press [ENTER].</p> <p>The lock symbol appears when the title is protected.</p> 
Shorten HDD RAM	<p>You can remove unnecessary parts of the recording such as commercials.</p> <ol style="list-style-type: none"> ① Press [ENTER] at the start point and end point of the section you want to erase. ② Press [▲, ▼] to select “Exit” and press [ENTER]. <ul style="list-style-type: none"> •Select “Next” and press [ENTER] to erase other sections. ③ Press [◀, ▶] to select “Erase” and press [ENTER]. 
Change Thumbnail HDD RAM DVD-R	<p>You can change the image to be shown as the thumbnail picture in the Title View.</p> <ol style="list-style-type: none"> ① Press [▶] (PLAY) to start play. ② Press [ENTER] when the image you want to use as a thumbnail is shown. ③ Press [▲, ▼] to select “Exit” and press [ENTER]. 
Divide Title HDD RAM	<p>You can divide a title into two.</p> <ol style="list-style-type: none"> ① Press [ENTER] at the point you want to divide the title. ② Press [▲, ▼] to select “Exit” and press [ENTER]. ③ Press [◀, ▶] to select “Divide” and press [ENTER]. <p>To confirm the division point Press [▲, ▼] to select “Preview” and press [ENTER]. (The unit plays 10 seconds before and after the division point.)</p> <p>To change the division point Restart play and press [▲, ▼] to select “Divide”, then press [ENTER] at the point you want to change.</p> <p>Note</p> <ul style="list-style-type: none"> •The divided titles retain the name and CPRM property (➔ page 53) of the original title. •Video and audio just before and after the dividing point may momentarily cut out. 

* Multiple editing is possible.

Chapter operations

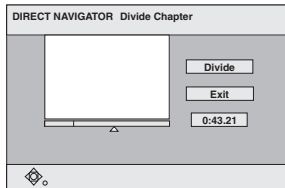
Erase Chapter* HDD RAM	<p>Press [◀, ▶] to select “Erase” and press [ENTER].</p> <ul style="list-style-type: none"> •Once erased, the recorded contents are lost and cannot be restored. Make certain before proceeding.
Divide Chapter HDD RAM	<ol style="list-style-type: none"> ① Press [ENTER] at the point you want to divide. <ul style="list-style-type: none"> •Repeat this step to divide at other points. ② Press [▲, ▼] to select “Exit” and press [ENTER]. 
Combine Chapters HDD RAM	<p>Press [◀, ▶] to select “Combine” and press [ENTER].</p> <ul style="list-style-type: none"> •The selected chapter and next chapter are combined.

* Multiple editing is possible.

For quicker editing

- Use search, Time Slip or slow-motion (➔ page 25) to find the desired point.
- Press [|◀◀, ▶▶|] to skip to the end of a title.

Editing and playing play lists/chapters

- 1 Press [FUNCTIONS].
- 2 Press [▲, ▼, ◀, ▶] to select “PLAY LIST” and press [ENTER].
- 3 Press [▲, ▼, ◀, ▶] to select the play list.

To start play → Press [ENTER].
To edit → Step 4.

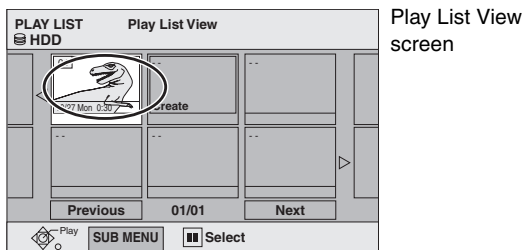

Play List View screen

•To show other pages/Multiple editing (→ page 32)

- 4 Press [SUB MENU], then [▲, ▼] to select the operation and press [ENTER].

•If you select “Edit”, press [▲, ▼] to select the operation and press [ENTER].

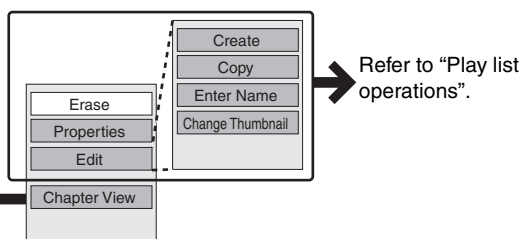

If you select “Chapter View”

- 5 Press [▲, ▼, ◀, ▶] to select the chapter.

To start play → Press [ENTER].
To edit → Step 6.

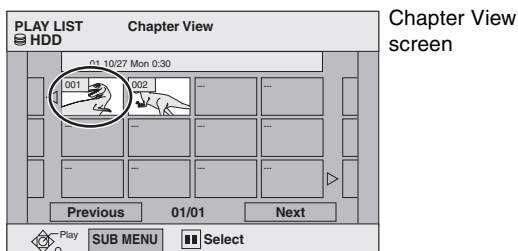

Chapter View screen

•To show other pages/Multiple editing (→ page 32)

- 6 Press [SUB MENU], then [▲, ▼] to select the operation and press [ENTER].

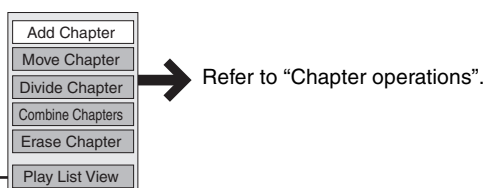

•You can go back to the Play List View.

To exit the screen

Press [RETURN] several times.

To return to the previous screen

Press [RETURN].

Play list operations

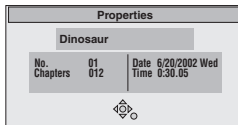
Erase*	Press [◀, ▶] to select “Erase” and press [ENTER].
Properties	Play list information (e.g., time and date) is shown. 
Create	→ page 34, Creating play lists
Copy*	Press [◀, ▶] to select “Copy” and press [ENTER].
Enter Name	→ page 46, Entering text
Change Thumbnail	→ page 33, Change Thumbnail

* Multiple editing is possible.

Chapter operations

Editing chapters in a play list does not modify the source titles and source chapters.

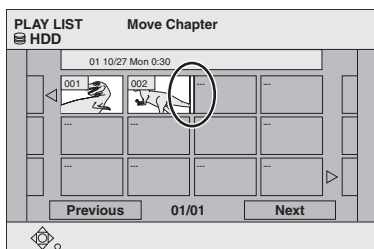
Add Chapter	→ page 34, Creating play lists, Step 4–6
Move Chapter	Press [▲, ▼, ◀, ▶] to select the position to insert the chapter and press [ENTER]. 
Divide Chapter	→ page 33, Divide Chapter
Combine Chapters	→ page 33, Combine Chapters
Erase Chapter*	→ page 33, Erase Chapter

* Multiple editing is possible.

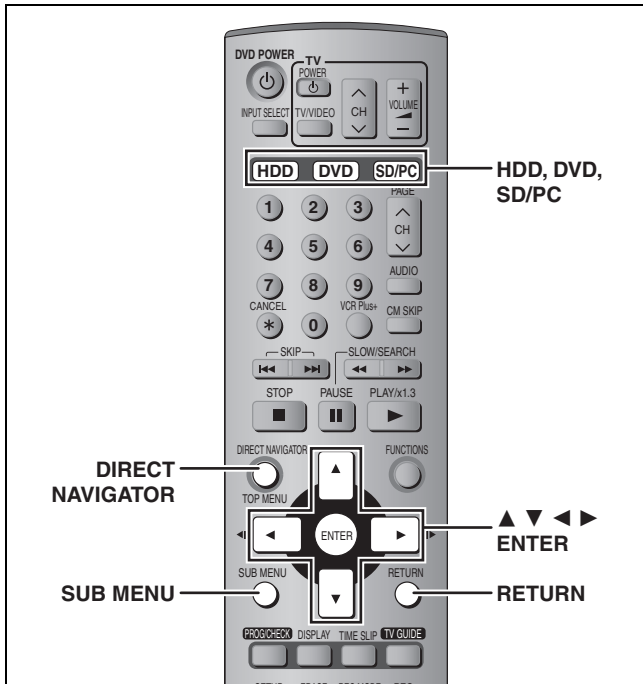

HDD RAM SD PC

Preparation

- Press [HDD], [DVD] or [SD/PC] to select the drive.
- Release protection (⇒ page 44).

1 Press [DIRECT NAVIGATOR].

To exit the screen
Press [DIRECT NAVIGATOR].

- 2 [HDD] [RAM]**
Press [**▲**, **▼**, **◀**, **▶**] to select “**PICTURE**” tab and press [ENTER].
- 3** Press [**▲**, **▼**, **◀**, **▶**] to select the still picture.
 - To show other pages/Multiple editing (⇒ page 32)
 - To select the still pictures in another folder (⇒ page 29)
- 4** Press [SUB MENU], then [**▲**, **▼**] to select the operation and press [ENTER].

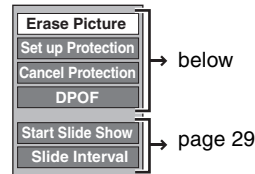

■ To edit still picture folders

In step 3 (⇒ above)

- ① Press [**▲**, **▼**, **◀**, **▶**] to select “**Folder**” and press [ENTER].
- ② Press [**▲**, **▼**] to select the folder.
 - To show other pages/Multiple editing (⇒ page 32)
- ③ Press [SUB MENU], then [**▲**, **▼**] to select the operation and press [ENTER].
 - To select another higher folder (⇒ page 29)

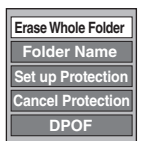

To return to the previous screen
Press [RETURN].

Picture and folder operation

Erase Picture*
Erase Whole Folder*
HDD RAM SD PC

Press [◀**, **▶**] to select “Erase” and press [ENTER].**

- Once erased, the recorded contents are lost and cannot be restored. Make certain before proceeding.
- When erasing a folder, even the files not containing still pictures will also be erased if they are inside the folder. (This does not apply to folders under the folder concerned.)

Set up Protection*
Cancel Protection*
HDD RAM SD PC

If set, this will protect the still picture or folder from accidental erasure.

Press [◀**, **▶**] to select “Yes” and press [ENTER].**

- The lock symbol appears when the still picture or folder is protected.
- Even if the protection setting is used by this unit to protect a folder, the folder may be erased by another unit.



DPOF*
SD PC

You can select a whole folder or individual pictures for printing and specify the number of prints to be made.

Press [◀**, **▶**] to select number of print (0 to 9) and press [ENTER].**

- The DPOF mark appears.
- This appears on the still pictures inside a folder when you make the DPOF setting for the folder.

To cancel the print setting

Set the number of print to “0”.

- When this is set by this unit, any settings established by other units will be released.
- Print settings (DPOF) made using this unit may not be viewable on other equipment.
- Settings cannot be made for folders and files not in accordance with DCF standards or if there is no remaining space on the card.

Folder Name
HDD RAM SD PC

You can give names to still picture folders.

- ⇒ page 46, Entering text
- Folder names input using this unit may not be displayed on other equipment.

* Multiple editing is possible.

Transferring (dubbing) titles or play lists

HDD **RAM** **DVD-R**

You can select from a variety of methods to transfer (dub) on this unit.

■ Transferring (dubbing) direction

<p>You can transfer (dub) your favorite titles and play lists to an archive disc.</p> <ul style="list-style-type: none"> •Transferring (dubbing) a play list will create a title. 		<p>When you want to re-edit finalized content on a DVD-R, etc.</p>
		<p>*Finalized DVD-R or DVD-Video on sale that is not copy-protected, etc.</p>

Normal speed mode: Select XP, SP, LP, EP or FR as the recording mode for transferring (dubbing) (⇒ page 17).

■ Transferring (dubbing) mode

Transferring (dubbing) a title or a play list	Transferring (dubbing) multiple titles and play lists together
↓	↓
One Touch Transfer (dubbing) (⇒ page 38)	Transferring (dubbing) using the transferring (dubbing) list (⇒ page 38)
	↓
You can select transferring (dubbing) speed mode and picture quality (⇒ below)	

■ Transferring (dubbing) speed mode types and features

	High speed	Normal speed (XP, SP, LP, EP, FR)
Features	You can transfer (dub) in a very short amount of time. You can transfer (dub) even faster if you use a high speed recording compatible disc. You can record and play using the HDD while high speed transferring (dubbing).	You can record for a long period of time on 1 disc. For example, using LP mode, you can record approximately 4 hours on 1 (4.7 GB) disc (⇒ page 17). e.g., 1 hour TV drama Only one episode using XP mode 4 episodes using LP mode
Transferring (dubbing) times	⇒ below, Approximate transferring (dubbing) times	The same amount of time it takes to record the source
Picture quality	Original picture quality	Can change*
Are chapters/thumbnails maintained?	Yes	No (One title is recorded as one chapter. Thumbnails return to the default position.)
Other operations while transferring (dubbing)	You can record/play using the HDD.	No

*If you select a recording mode with better picture quality than the original, the picture quality does not improve. (However, it does prevent against degradation of picture quality.)

■ Approximate transferring (dubbing) times (Max. speed)

HDD		3× high speed recording compatible DVD-RAM		4× high speed recording compatible DVD-R	
Recording mode	Recording time	Required time	Speed	Required time	Speed
XP	1 hour	Approx. 20 min.	3×	Approx. 15 min.	4×
SP		Approx. 10 min.	6×	Approx. 7.5 min.	8×
LP		Approx. 5 min.	12×	Approx. 4 min.	16×
EP (6H)		Approx. 3.5 min.	18×	Approx. 2.5 min.	24×
EP (8H)		Approx. 2.5 min.	24×	Approx. 2 min.	32×

Note

- When recording or playing while transferring (dubbing), the unit may not use the maximum recording speed.
- Depending on the condition of the disc, the unit may not transfer (dub) using the maximum speed.

Regarding high speed transfer (dubbing) to DVD-R

To high speed transfer (dub) titles (or play lists created from those titles), set “DVD-R High-Speed Recording” to “On” before recording to the HDD (⇒ page 48).

However, in the following cases, transferring (dubbing) to DVD-R using the high speed mode does not work.

- Play lists created from titles using a variety of recording modes
- Play lists created from multiple titles using FR recording mode
- Play lists mixed with a variety of audio types (Dolby Digital and LPCM, etc.)
- Titles that contain many erased segments.

Regarding transferring (dubbing) of digital broadcasts that allow “One time only recording”

You can transfer (dub) a recorded title to a CPRM (⇒ page 53) compatible DVD-RAM; however, the title is erased from the HDD.

- You cannot use one touch transfer (dubbing). Use the transferring (dubbing) list (⇒ page 38).
- Titles will not be transferred if they are protected (⇒ page 33).
- You cannot transfer play lists created from “One time only recording” titles.
- Titles with recording limitations and play lists cannot be registered on the same transferring (dubbing) list.
- Titles or play lists cannot be transferred from DVD-RAM to the HDD.

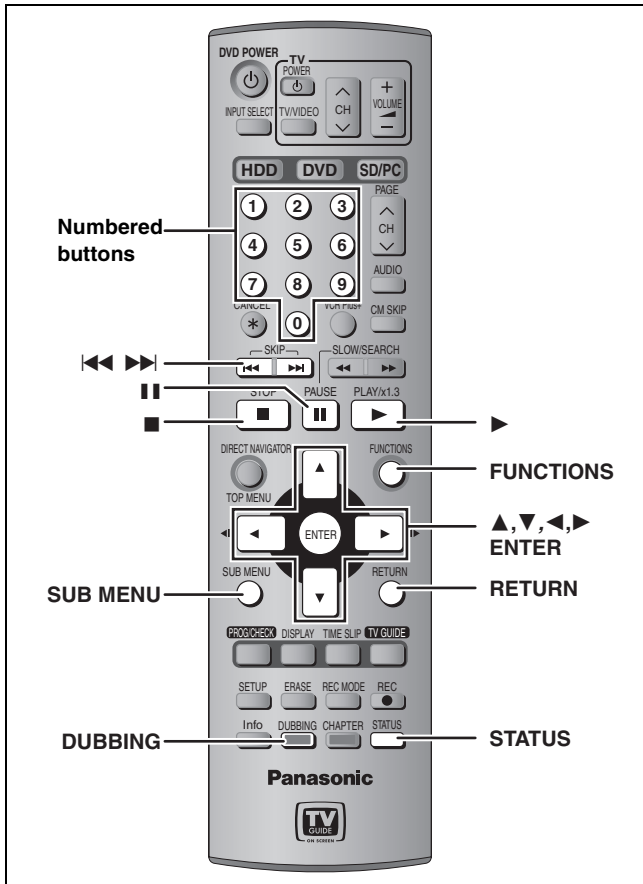

One Touch Transfer (dubbing)

HDD → RAM
HDD → DVD-R

Preparation

Select the audio type for recording bilingual broadcast from “Select MTS” (⇒ page 48) when transferring (dubbing) to a DVD-R.

- 1 Play the title or play list you want to transfer (dub).
- 2 Press [DUBBING].

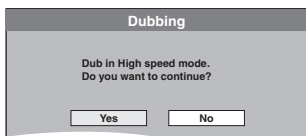

- 3 Press [◀, ▶] to select “Yes” and press [ENTER].

•The transfer (dubbing) speed and picture quality are set as follows.

The recording mode changes to FR mode if the remaining disc space is exceeded using one of the recording modes indicated below.

HDD → RAM: High speed mode
HDD → DVD-R:

DVD-R High-Speed Recording setting	
On	Off
High speed mode	Same recording mode used as when recording the source title (XP-EP, FR). •Play lists are transferred (dubbed) in FR mode.

Note

Titles and play lists cannot be transferred (dubbed) if they contain digital broadcast that allows “One time only recording”.

Transferring (dubbing) using the transferring (dubbing) list

HDD ↔ RAM
HDD → DVD-R

You can order titles and play lists for transfer (dubbing) as desired as well as select the speed and picture quality.

Preparation

Select the audio type for recording bilingual broadcast from “Select MTS” (⇒ page 48) when:

- Transferring (dubbing) to a DVD-R.
- When “Audio for XP Recording” is set to “LPCM” (⇒ page 49) and you are transferring (dubbing) in XP mode.

- 1 While stopped Press [FUNCTIONS].
- 2 Press [▲, ▼, ◀, ▶] to select “DUBBING” and press [ENTER].

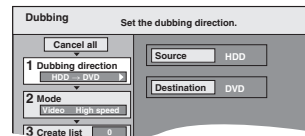

- If you are not going to change the registered list press [▼] several times (⇒ step 7).

- 3 Press [▲, ▼] to select “Dubbing direction” and press [▶].
 - ① Press [▲, ▼] to select “Source” and press [ENTER].
 - ② Press [▲, ▼] to select the drive and press [ENTER].
 - ③ Press [▲, ▼] to select “Destination” and press [ENTER].

The same drive as the transfer (dubbing) source cannot be selected.

 - ④ Press [▲, ▼] to select the drive and press [ENTER].
 - ⑤ Press [◀] to confirm.
- 4 Press [▲, ▼] to select “Mode” and press [▶].
 - ① Press [▲, ▼] to select “Format” and press [ENTER].
 - ② Press [▲, ▼] to select “Video” and press [ENTER].
 - ③ Press [▲, ▼] to select “Recording Mode” and press [ENTER].
 - ④ Press [▲, ▼] to select the mode and press [ENTER].
 - ⑤ Press [◀] to confirm.
- 5 Press [▲, ▼] to select “Create list” and press [▶].

Select the transferring (dubbing) items and register on the list.

- When transferring (dubbing) to DVD-R using high speed mode, only items indicated with “▶▶▶” can be registered.

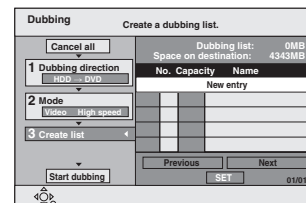

- ① Press [▲, ▼] to select “New entry” and press [ENTER].
- ② Press [▲, ▼, ◀, ▶] to select “Video” or “Play List” tab and press [ENTER].

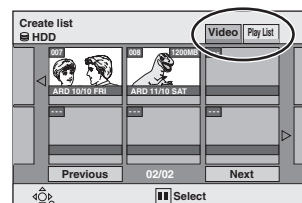

③ Press [**▲**, **▼**, **◀**, **▶**] to select the titles or play lists and press [ENTER].

• To select a multiple number of items together, press [**■**] to add the check mark and press [ENTER] (⇒ below, Multiple editing).

• To show other pages (⇒ below)

• To edit the transferring (dubbing) list (⇒ below)

6 Press [**▲**, **▼**] to select “SET” and press [ENTER].

The transferring (dubbing) list is registered.

7 Press [**▲**, **▼**] to select “Start dubbing” and press [ENTER].

Press [**◀**, **▶**] to select “Yes” and press [ENTER] to start transferring (dubbing).

■ To edit the transferring (dubbing) list

Select the item in step 5 (⇒ page 38, right column)

1 Press [SUB MENU].

2 Press [**▲**, **▼**] to select the operation and press [ENTER].

* Multiple editing is possible (⇒ below).



To cancel all registered transferring (dubbing) setting and lists

In step 3 (⇒ page 38, right column)

1 Press [**▲**, **▼**] to select “Cancel all” and press [ENTER].

2 Press [**◀**, **▶**] to select “Yes” and press [ENTER].

• The settings and lists may be cancelled in the following situations.

– When a title, still picture, etc. has been erased at the transfer (dubbing) source

– When steps have been taken, for instance, to turn off the unit, open the tray, change the transfer (dubbing) direction, etc.

To show other pages

Press [**▲**, **▼**, **◀**, **▶**] to select “Previous” or “Next” and press [ENTER].

• You can also press [**◀◀**, **▶▶**] to show other pages.

Multiple editing

Select with [**▲**, **▼**, **◀**, **▶**] and press [**■**]. (Repeat.)

Press [ENTER] to register to the list.

• A check mark appears. Press [**■**] again to cancel.

• When you switch between the “Video” and “Play List” tab, the check mark is cancelled.

Transferring (dubbing) list icons



Titles and play lists that can be transferred (dubbed) in high speed mode to DVD-R (⇒ page 48)



Title with “One time only recording” restriction



Titles erased from the HDD by “One time only recording” restriction after transferring (dubbing).



Title or play list contains still picture(s)
• Still picture(s) cannot be transferred (dubbed).

Data size of each registered item

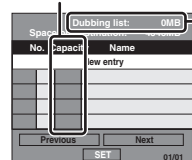

Data size recorded to the transfer (dubbing) destination

• For normal speed transfer (dubbing), the total data size changes according to the recording mode.

• When transferring (dubbing) to the HDD using high speed mode, data management information is automatically added so the total data size becomes larger than the sum of the data size for all registered items.

■ To stop transferring (dubbing)

Press and hold [RETURN] for 3 seconds.

• If stopped partway, transferring (dubbing) will be up to that point. However, in high speed mode, only titles that have completed transferring (dubbing) at the point stopped are transferred (dubbed). [Even if the title was not transferred (dubbed) to the DVD-R, the amount of remaining writable disc space becomes less.]

■ To return to the previous screen

Press [RETURN].

■ Recording and playing while transferring (dubbing)

You can record and play using the HDD while high speed transferring (dubbing).

Press [ENTER] to cancel the screen display.

• To confirm the current progress

Press [STATUS].

Note

• You cannot perform chasing play or edit, etc. while transferring (dubbing).

• Timer recordings executed while transferring (dubbing) are recorded to the HDD regardless of the recording drive settings.

• You cannot play a play list while transferring (dubbing) titles with “One time only recording” restriction (⇒ page 37).

Refer to the control reference on page 38.

Transferring (dubbing) a finalized DVD-R

DVD-V → HDD

While playing a disc, the content being played is transferred (dubbed) to the HDD according to the set time.



- Operations and on screen displays during transfer (dubbing) are also recorded.
- Almost all DVD-Video on sale have been treated to prevent illegal copying, and cannot be transferred (dubbed).
- The following cannot be transferred (dubbed): DVD-Audio, Video CD, Audio CD and so on.

After performing steps 1–4 (⇒ page 38, right column)

5 Press [▲, ▼] to select “Time to end” and press [▶].

6 Press [◀, ▶] to select “Hour” and “Min.” and press [▲, ▼] to set the recording time.

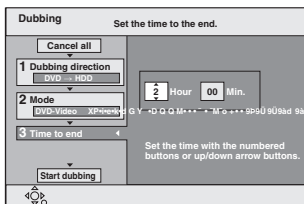

- You can also set the recording time with the numbered buttons.
- Set a few minutes longer than the source title, in order to include the operation time before play begins.

7 Press [◀] to select “Time to end”.

8 Press [▲, ▼] to select “Start dubbing” and press [ENTER].

Press [◀, ▶] to select “Yes” and press [ENTER] to start transferring (dubbing).

The disc top menu is displayed.

- Disc play automatically begins from title 1 when “Title 1” is selected from the “Select First play” menu when finalizing the disc (⇒ page 45).

9 When the top menu is displayed Press [▲, ▼, ▶, ◀] to select the title you want to start transferring (dubbing), and press [ENTER].

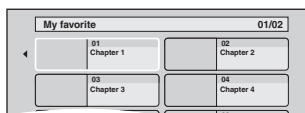

While playing in order, all the titles after the selected title are recorded until the set time. (After the last title on the disc has finished playing the top menu is recorded until the set time is reached.)

Note

- The screen on the right (screen saver) is recorded at the beginning.
- Recorded as 1 title from the start of transfer (dubbing) to the end.
- If play does not begin automatically or if the top menu does not display automatically, press [▶] (PLAY) to start.
- Even if you transfer (dub) a high quality video/audio DVD, the original picture and audio quality cannot be exactly replicated.

To stop transferring (dubbing)

Press [■].

You can also press and hold [RETURN] for 3 seconds to stop transferring (dubbing).

- If stopped partway, transferring (dubbing) will be up to that point.

To return to the previous screen

Press [RETURN].

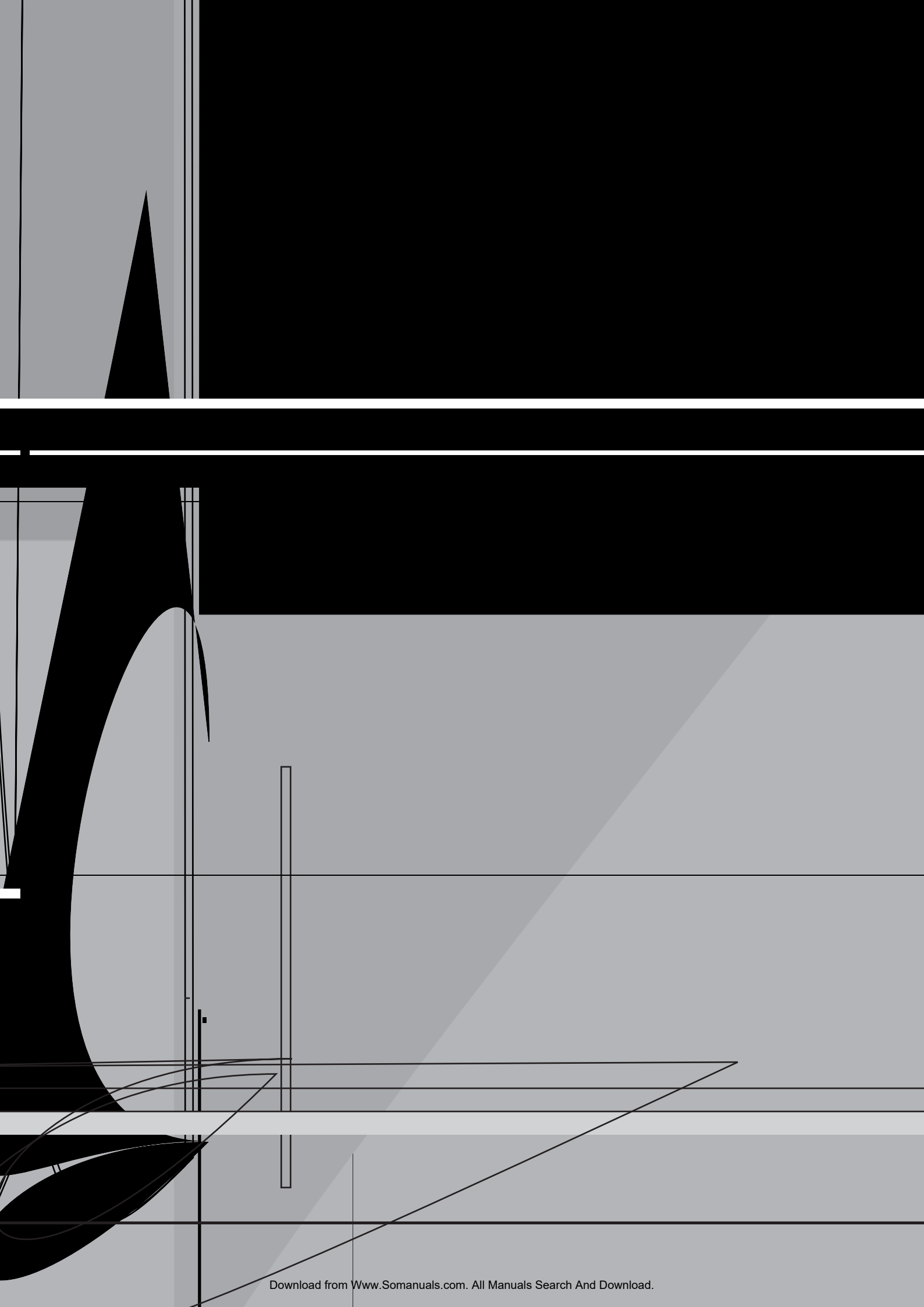

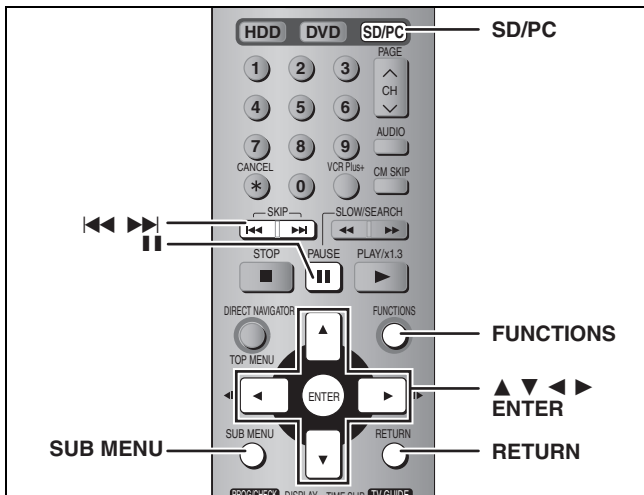

HDD | RAM | SD | PC

Transferring (dubbing) using the transferring (dubbing) list

- While stopped Press [FUNCTIONS].
- Press [▲, ▼, ◀, ▶] to select "DUBBING" and press [ENTER].

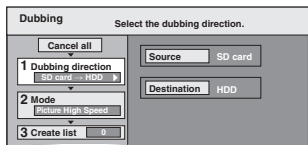

If you are not going to change the registered list press [▼] several times (⇒ step 7).

- Press [▲, ▼] to select "Dubbing direction" and press [▶].
 - Press [▲, ▼] to select "Source" and press [ENTER].
 - Press [▲, ▼] to select the drive and press [ENTER].
 - Press [▲, ▼] to select "Destination" and press [ENTER].
 - Press [▲, ▼] to select the drive and press [ENTER].
The same drive as the transfer (dubbing) source can be selected.
 - Press [◀] to confirm.
- Press [▲, ▼] to select "Mode" and press [▶].
 - Press [▲, ▼] to select "Format" and press [ENTER].
 - Press [▲, ▼] to select "Picture" and press [ENTER].
"Recording mode" is automatically set to "High speed".
 - Press [◀] to confirm.

- Press [▲, ▼] to select "Create list" and press [▶].
Select the transferring (dubbing) items and register on the list.

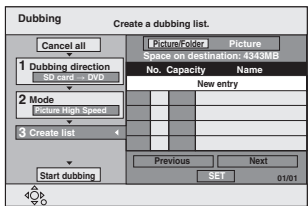

- To register individual still pictures**
 - Press [▲, ▼] to select "New entry" and press [ENTER].
 - Press [▲, ▼, ◀, ▶] to select a still picture and press [ENTER].
 - To select a multiple number of items together, press [■] to add the check mark and press [ENTER] (⇒ right, Multiple editing).
 - To show other pages (⇒ right)
 - To select the still pictures in another folder (⇒ right)
 - To edit the transferring (dubbing) list (⇒ right)

To register on a folder by folder basis

- Press [▲, ▼] to select "Picture/Folder" and press [ENTER].
 - Press [▲, ▼] to select "Folder" and press [ENTER].
 - Press [▲, ▼] to select "New entry" and press [ENTER].
 - Press [▲, ▼] to select the folder and press [ENTER].
- To select a multiple number of items together, press [■] to add the check mark and press [ENTER] (⇒ below, Multiple editing).
 - To show other pages (⇒ below)
 - To switch another higher folder (⇒ below)
 - To edit the transferring (dubbing) list (⇒ below)
- Still pictures and folders cannot be registered on the same list.

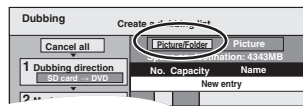

- Press [▲, ▼] to select "SET" and press [ENTER].
The transferring (dubbing) list is registered.

- Press [▲, ▼] to select "Start dubbing" and press [ENTER].

- For individual still pictures only
When specifying another folder as the transferring (dubbing) destination, select "Folder".

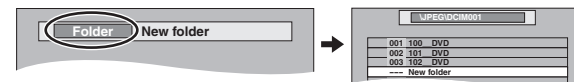

Press [◀, ▶] to select "Yes" and press [ENTER] to start transferring (dubbing).

To stop transferring (dubbing)

Press and hold [RETURN] for 3 seconds.

To return to the previous screen

Press [RETURN].

To select another folder

- Press [▲, ▼, ◀, ▶] to select "Folder" and press [ENTER].
- Press [▲, ▼] to select the folder and press [ENTER].



- The still pictures of different folders cannot be registered on the same list.
- If there is a multiple number of higher folders recognizable, you can switch them using [◀, ▶]. (Folders whose higher folders are different cannot be registered on the same list.)



To edit the transferring (dubbing) list

Select the item in step 5 (⇒ left)

- Press [SUB MENU].
- Press [▲, ▼] to select the operation and press [ENTER].

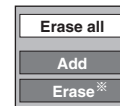

* Multiple editing is possible (⇒ below).

To cancel all registered transferring (dubbing) setting and lists

In step 3 (⇒ left)

- Press [▲, ▼] to select "Cancel all" and press [ENTER].
 - Press [◀, ▶] to select "Yes" and press [ENTER].
- The settings and lists may be cancelled in the following situations.
 - When a still picture or folder has been recorded or erased at the transfer (dubbing) source
 - When steps have been taken, for instance, to turn off the unit, remove the card, open the tray, change the transfer (dubbing) direction, etc.

To show other pages

Press [▲, ▼, ◀, ▶] to select "Previous" or "Next" and press [ENTER].

You can also press [◀◀, ▶▶] to show other pages.

Multiple editing

Select with [▲, ▼, ◀, ▶] and press [■]. (Repeat.) Press [ENTER] to register to the list.

A check mark appears. Press [■] again to cancel.

Transferring (dubbing) all the still pictures on a card—COPY ALL PICTURES

SD or PC → HDD or RAM

Preparation

Press [SD/PC] to select the source drive.

- 1** While stopped
Press [FUNCTIONS].
- 2** Press [▲, ▼, ◀, ▶] to select “COPY ALL PICTURES” and press [ENTER].

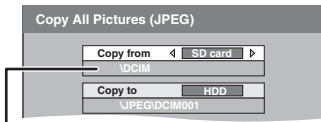

• If there is a multiple number of higher folders recognizable, you can switch them using [◀, ▶].

- 3** Press [▲, ▼] to select “Copy from” and press [◀, ▶] to select the drive.
- 4** Press [▲, ▼] to select “Copy to” and press [◀, ▶] to select the drive.
- 5** Press [▲, ▼, ◀, ▶] to select “Copy” and press [ENTER].

To stop transferring (dubbing)

Press and hold [RETURN] for 3 seconds.

To return to the previous screen

Press [RETURN].

Note

- When transferring (dubbing) the still pictures on a folder by folder or card by card basis, files other than the still picture files inside the folder will also be transferred (dubbed). (This does not apply to the lower folders contained inside the folders.)
- If still pictures are already contained inside the transfer (dubbing) destination folder, the new still pictures are recorded following the existing still pictures.
- If the space on the destination drive runs out or the number of files/folders to be transferred (dubbed) exceeds the maximum (→ page 28), transferring (dubbing) will stop partway through.
- When a name has been input by this unit for the transfer (dubbing) source folder, the folder name will be reflected in the transfer (dubbing) destination folder.
- Print number setting (DPOF) is not transferred (dubbed).
- The sequence in which the still pictures are registered on the transfer (dubbing) list may not be reflected at the transfer (dubbing) destination.

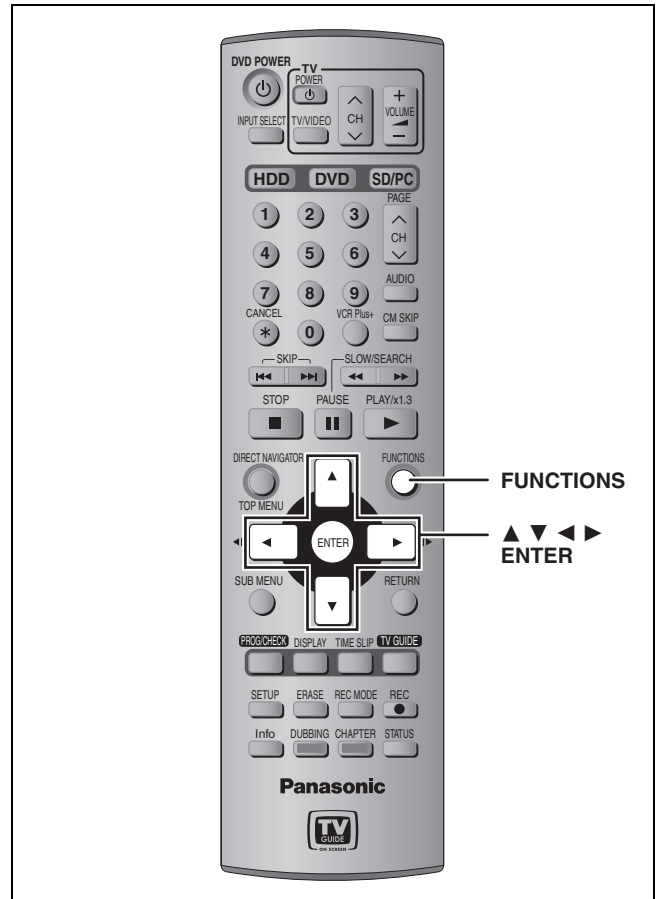

Transfer (Dubbing)

Convenient functions

By using the FUNCTIONS window you may access the main functions quickly and easily.

- 1** While stopped
Press [FUNCTIONS].

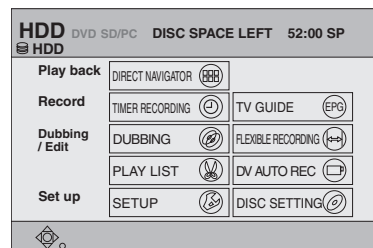

Functions displayed depend on the selected drive or type of disc.

- 2** Press [▲, ▼, ◀, ▶] to select an item and press [ENTER].

To exit the FUNCTIONS window

Press [FUNCTIONS].

Erasing all the contents of a disc or card—Format

HDD RAM SD PC

Preparation

- Press [HDD], [DVD] or [SD/PC] to select the drive.
- Release protection (→ page 44).

- 1 While stopped
Press [FUNCTIONS].
- 2 Press [▲, ▼, ◀, ▶] to select “DISC SETTING” or “CARD SETTING” and press [ENTER].
- 3 Press [▲, ▼] to select “Format” or “Format disc” and press [ENTER].
- 4 Press [◀, ▶] to select “Yes” and press [ENTER].
- 5 Press [◀, ▶] to select “Start” and press [ENTER].
A message appears when formatting is finished.
- 6 Press [ENTER].

Note

- Formatting erases all contents (including computer data), and it cannot be restored. Check carefully before proceeding. The contents are erased when you format it even if you have set protection.
- Do not disconnect the AC power supply cord while formatting. This can render the disc unusable. Formatting normally takes a few minutes, however it may take up to a maximum of 70 minutes (RAM).

To stop formatting

- Press [RETURN].
(You can cancel formatting if it takes more than 2 minutes. The disc or card must be reformatted if you do this.)
- Formatting cannot be performed on DVD-R or CD-R/RW.
 - When a disc or card has been formatted using this unit, it may not be possible to use it on any other equipment.
 - You cannot format a Microdrive or mobile hard disk on this unit.

Enabling DVD-R to be played on other equipment—Finalize

DVD-R

Preparation

Press [DVD] to select the DVD drive.

- 1 While stopped
Press [FUNCTIONS].
- 2 Press [▲, ▼, ◀, ▶] to select “DISC SETTING” and press [ENTER].

3 Press [▲, ▼] to select “TOP MENU” and press [ENTER].

Press [▲, ▼, ◀, ▶] to select the background and press [ENTER].

You can select the background that will be displayed as the DVD-Video top menu after finalizing.

- You can change thumbnails displayed in the top menu. (→ page 33, Change Thumbnail)

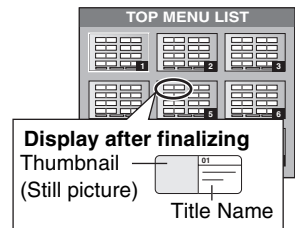

4 Press [▲, ▼] to select “Select First play” and press [ENTER].

Press [▲, ▼] to select “Top Menu” or “Title 1” and press [ENTER].

You can select whether to show the top menu after finalizing. Top Menu: The top menu appears first.

Title 1: The disc content is played without displaying the top menu.

5 Press [▲, ▼] to select “Finalize” and press [ENTER].

- ① Press [◀, ▶] to select “Yes” and press [ENTER].
- ② Press [◀, ▶] to select “Start” and press [ENTER].
A message appears when finalizing is finished.
- ③ Press [ENTER].

Note

After finalizing

- The disc becomes play-only and you can no longer record or edit.
- When transferring (dubbing) in high speed, chapters will be replicated.
- Titles are divided into about 5-minute* chapters, if
 - the titles were directly recorded to DVD-R.
 - the titles were transferred (dubbed) using any mode other than the high speed mode.
- * This time varies greatly depending on the condition and mode of recording.
- There is a pause of several seconds between titles and chapters during play.

Do not disconnect the AC power supply cord while finalizing. This will render the disc unusable.

- Finalizing takes up to 15 minutes.
- You cannot finalize DVD-R recorded on other manufacturer's equipment.
- If you finalize a recorded DVD-R on Panasonic equipment other than this unit, the background selected as “TOP MENU” may not display.

	Before finalizing	After finalizing
Disc display on this unit	DVD-R	DVD-V
Recording/Editing/Entering name	○	×
Play on other players	×	○

DVD-R finalized on this unit may not be playable on other players due to the condition of the recording.

- Visit Panasonic's homepage for more information about DVDs.
<http://www.panasonic.com/playDVD-R>

To exit the screen

Press [RETURN] several times.

To return to the previous screen

Press [RETURN].

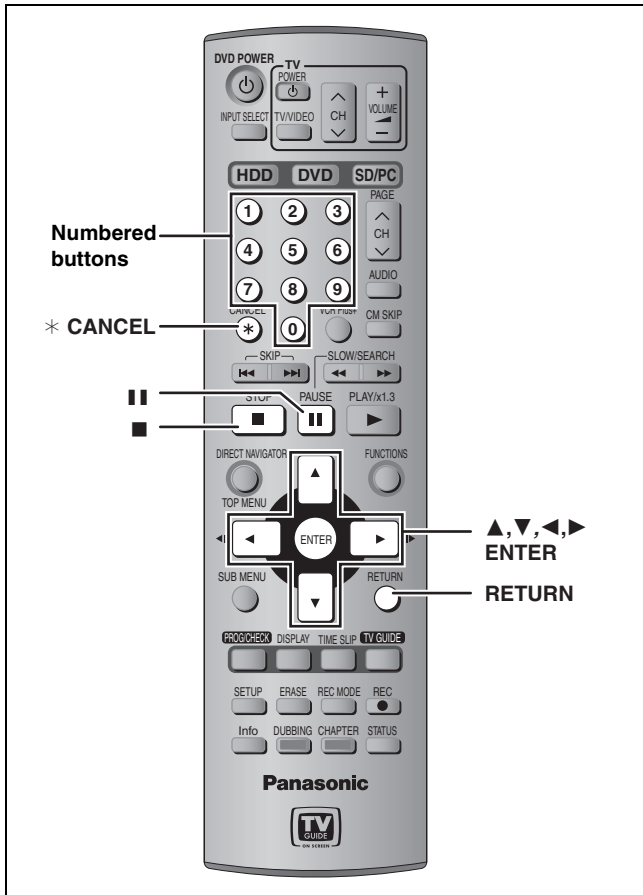

HDD RAM DVD-R SD PC

You can give names to recorded titles, etc.

The maximum number of characters:

HDD RAM	Characters
Title	64
Play list	64
Disc	64
Folder of still pictures	36

DVD-R	Characters
Title	44
Disc	40

SD PC	Characters
Folder of still pictures	36

Note

If a name is long, parts of it may not be shown in some screens.

1 Show Enter Name screen.

- Title**
Select "Enter Name" in step 4 on page 32.
- Play list**
Select "Enter Name" in step 4 on page 35.
- Disc**
Select "Disc Name" in step 3 on page 44.
- Folder of still pictures**
Select "Folder Name" in step 4 on page 36.

Name field: shows the text you have entered

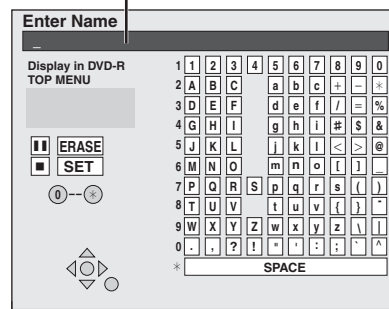

2 Press [▲, ▼, ◀, ▶] to select a character and press [ENTER].

Repeat this step to enter other characters.

• **To erase a character**

Press [▲, ▼, ◀, ▶] to select the character in the name field and press [■].

• **Using the numbered buttons to enter characters**

e.g., entering the letter "R"

- ① Press [7] to move to the 7th row.
- ② Press [7] twice to highlight "R".
- ③ Press [ENTER].

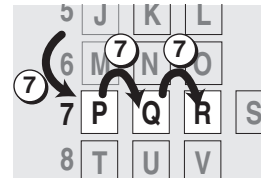

• **To enter a space**

Press [* CANCEL] and press [ENTER].

3 Press [■] (SET).

Returns to the previously displayed screen.

To end partway

Press [RETURN].
Text is not saved.

For your reference

If you enter a long name, only part of it is shown in the TOP MENU after finalization (➡ page 45). When entering a title name, the name that will appear in the TOP MENU can be previewed in "Display in DVD-R TOP MENU" window.

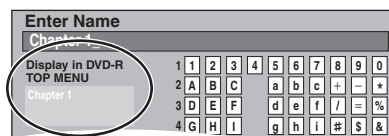

Changing the unit's settings

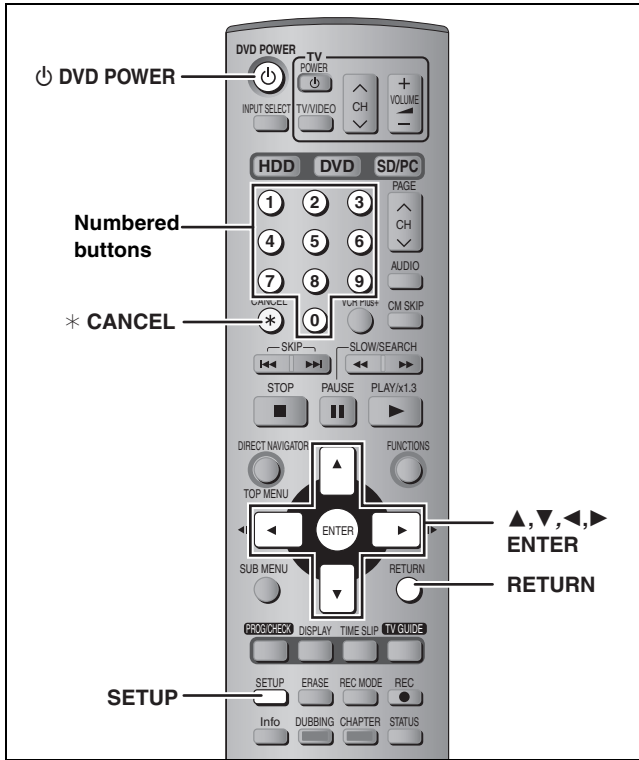

Common procedures

- 1 While stopped
Press [SETUP].
-
- 2 Press [▲, ▼] to select the tab and press [▶].
 - 3 Press [▲, ▼] to select the menu and press [ENTER].
 - 4 Press [▲, ▼] to select the option and press [ENTER].

To exit the screen

Press [SETUP].

To return to the previous screen

Press [RETURN].

Summary of settings

The settings remain intact even if you switch the unit to standby.

*1 You need to set these menus only when you do not use TV Guide On Screen™ system. These menus turn gray and become un-selectable after this unit downloads the television program list.



*2 You can set these menus only after "Auto Channel Setting" is completed.

Tabs	Menus	Options (Underlined items are the factory presets.)
Channel	TV GUIDE Setting Set the TV Guide On Screen™ system.	
	Antenna System *2 Select to suit the type of antenna you are using.	●TV ● <u>CATV</u>
	Auto Channel Setting *1 (⇒ page 50)	—
	Preset Channel Captions *2 (⇒ page 51)	—
	Manual Channel Captions *2 (⇒ page 51)	—
Set Up	Off Timer Select how long the unit remains on when it is not being used.	●2 hr ● <u>6 hr</u> ●Off
	Remote Control Code (⇒ page 13)	● <u>Set Code 1</u> ●Set Code 2 ●Set Code 3
	Auto Clock Setting *1 (⇒ page 50)	—
	Manual Clock Setting *1 (⇒ page 11)	—
	Time Zone Adjust *1 (⇒ page 50)	●-1 ● <u>0</u> ●+1
	Re-initialize Settings This returns all values in the SETUP menus, except for the clock, channel settings, ratings level, and on-screen language, to the default settings.	●Yes ● <u>No</u>
Disc	Languages Choose the language for audio, subtitle and disc menus. DVD-V ●Press [ENTER] to show the following settings. ●Some discs start in a certain language despite any changes you make here.	●Enter a code (⇒ page 55) with the numbered buttons when you select "Other ****". When the selected language is not available on the disc, the default language is played. There are discs where you can only switch the language from the menu screen (⇒ page 24).
	Audio Language	● <u>English</u> ●French ●Spanish ●Original: The original language of each disc will be selected. ●Other ****
	Subtitle Language	● <u>Automatic</u> : If the language selected for "Audio Language" is not available, subtitles of that language will automatically appear if available on that disc. ●English ●French ●Spanish ●Other ****
	Menu Language	● <u>English</u> ●French ●Spanish ●Other ****

Continued on next page

Tabs	Menus	Options (Underlined items are the factory presets.)
Disc Continued	Ratings Set a ratings level to limit DVD-Video play. Follow the on-screen instructions. Enter a 4-digit password with the numbered buttons when the password screen is shown. ● Do not forget your password.	● <u>8 No Limit</u> : All DVD-Video can be played. ● <u>1 to 7</u> : Prohibits play of DVD-Video with corresponding ratings recorded on them. ● <u>0 Lock All</u> : Prohibits play of all DVD-Video.
	Recording Time in EP Mode Select the maximum number of hours for recording in EP mode (⇒ page 17, Recording modes and approximate recording times).	● <u>EP (6H)</u> : You can record for 6 hours on an unused 4.7 GB disc. ● <u>EP (8H)</u> : You can record for 8 hours on an unused 4.7 GB disc.
	Play DVD-Audio in Video Mode Select "Video (On)" to play DVD-Video content on some DVD-Audio.	● <u>Video (On)</u> : The setting returns to "Audio (Off)" when you change the disc or turn the unit off. ● <u>Audio (Off)</u>
	DVD-R High-Speed Recording When high speed transferring (dubbing) a title to DVD-R, it is necessary to turn this setting "On" before recording to HDD; however, the screen size, etc. is restricted (⇒ right). We recommend turning the setting "Off" if high speed transfer (dubbing) to DVD-R is not necessary when recording a program.	● <u>On</u> : Makes high speed mode transferring (dubbing) to DVD-R possible. Press [◀, ▶] to select "Yes" and press [ENTER]. ["▶▶▶"] appears in the transferring (dubbing) list (⇒ page 38). – Pictures are saved at 4:3. – Hybrid VBR Resolution (⇒ below) setting is "Fixed". – Select the type of audio in advance from "Select MTS" (⇒ below). ● <u>Off</u>
Video	3-D Y/C Separation	● <u>On</u> : Reduces noise by separating the luminance (Y) and color (C) signals when recording. ● <u>Off</u> : Reduces the ghosting that occurs when recording fast moving images.
	Hybrid VBR Resolution (⇒ page 53, VBR)	● <u>Automatic</u> : The resolution is automated to provide efficient recording with less block noise. HDD RAM ● <u>Fixed</u> : The resolution is fixed to ensure that there is no loss of source picture resolution while recording.
	Still Mode Select the type of picture shown when you pause play (⇒ page 53, Frames and fields).	● <u>Automatic</u> ● <u>Field</u> : Select if jittering occurs when "Automatic" is selected. ● <u>Frame</u> : Select if small text or fine patterns cannot be seen clearly when "Automatic" is selected.
	Seamless Play Select the play mode for play list chapter segments.	● <u>On</u> : The chapters in play lists are played seamlessly. This does not work when there are several audio types included on the play list and when using Quick View. Additionally, the positioning of chapter segments may change slightly. ● <u>Off</u> : The points where chapters in play lists change are played accurately, but the picture may freeze for a moment.
	Line-in NR Reduces video tape noise while transferring (dubbing). ● When noise reduction is on, "3-D Y/C Separation" (⇒ above) does not work regardless of the setting.	● <u>Automatic</u> : Noise reduction only works on picture input from a video tape. ● <u>On</u> : Noise reduction works for any video input. ● <u>Off</u> : Noise reduction is off. Select when you want to record input as is.
	Black Level Control Select normal, lighter or darker for adjusting the black level control to the desired setting for picture enhancement.	
	Input Level Adjusts the black level of the input signal.	● <u>Lighter</u> ● <u>Darker</u>
	Output Level (Composite/S Video) Adjusts the black level of the output signal from the VIDEO OUT and S-VIDEO OUT terminal.	● <u>Lighter</u> ● <u>Darker</u>
	Output Level (Component) Adjusts the black level of the output signal from the COMPONENT VIDEO OUT (Y/P _B /P _R) terminals.	● <u>Lighter</u> ● <u>Normal</u> ● <u>Darker</u>
Audio	Search Audio & PLAY ×1.3 You may hear sound regardless of this setting with some discs.	● <u>On</u> : Audio is heard during first level search forward. ● <u>Off</u> : Audio is not heard during search. Quick View (⇒ page 25) does not work.
	D. Range Compression DVD-V (Dolby Digital only) Change the dynamic range for late night viewing.	● <u>On</u> ● <u>Off</u>
	Select MTS Select the audio recording type, main or secondary (SAP) audio when: – Recording or transferring (dubbing) to a DVD-R. – Recording or transferring (dubbing) sound in LPCM. (⇒ page 49, Audio for XP Recording)	● <u>Main</u> ● <u>SAP</u> You cannot select this when recording from an external source onto DVD-R. Select audio on the other equipment.

Continued on next page

Audio Continued	Digital Audio Output Change the settings when you have connected equipment through this unit's DIGITAL AUDIO OUT terminal (⇒ page 9). ● Press [ENTER] to show the following settings.	
	PCM Down Conversion Select how to output audio with a sampling frequency of 96 kHz or 88.2 kHz.	<ul style="list-style-type: none"> ● <u>On</u>: Signals are converted to 48 kHz or 44.1 kHz. (Choose when the connected equipment cannot process signals with sampling frequency of 96 kHz or 88.2 kHz.) ● <u>Off</u>: Signals are output as 96 kHz or 88.2 kHz. (Choose when the connected equipment can process signals with sampling frequency of 96 kHz or 88.2 kHz.) Signals are converted to 48 kHz or 44.1 kHz despite the above settings if the signals have a sampling frequency of over 96 kHz or 88.2 kHz, or the disc has copy protection.
	 Dolby Digital Select how to output the signal, to output "Bitstream" so the connected equipment decodes the signal, or to decode on this unit and output the signal as "PCM" (2 channel).  DTS Note Not making the proper settings may result in noise, possibly damage your hearing and speakers, and digital recording may not work properly.	<ul style="list-style-type: none"> ● <u>Bitstream</u>: When connecting to equipment displaying the Dolby Digital logo. ● <u>PCM</u>: When connecting to equipment not displaying the Dolby Digital logo.
	Audio for XP Recording Choose the audio type when recording or transferring (dubbing) with XP mode.	<ul style="list-style-type: none"> ● <u>Dolby Digital</u> (⇒ page 53) ● <u>LPCM</u> (⇒ page 53) <ul style="list-style-type: none"> –The picture quality of LPCM recordings may be lower than that of normal XP mode recordings. –The audio recording becomes Dolby Digital even if you selected LPCM when using a recording mode other than XP. –When recording MTS broadcast, select the type of audio in advance from "Select MTS" (⇒ page 48).
Select Audio CH for DV Input You can select the kind of audio when recording from the unit's DV terminal (⇒ page 41).	<ul style="list-style-type: none"> ● <u>Stereo 1</u>: Records audio (L1, R1). ● <u>Stereo 2</u>: Records added audio such as narration (L2, R2) subsequent to original recording. ● <u>Mix</u>: Records both Stereo 1 and Stereo 2. When recording MTS broadcast, select the type of audio in advance from "Select MTS" (⇒ page 48).	
Display	Status Messages Choose whether to show status messages automatically.	<ul style="list-style-type: none"> ● <u>Automatic</u> ● <u>Off</u>
	On-screen Language Choose the language for these menus and on-screen messages.	<ul style="list-style-type: none"> ● <u>English</u> ● <u>Español</u> ● <u>Français</u> –Only English is displayed in the TV Guide On Screen™ system regardless of the settings. Other languages cannot be displayed.
	Blue Background Select "Off" if you do not want to have the unit show the blue background when reception is weak.	<ul style="list-style-type: none"> ● <u>On</u> ● <u>Off</u>
	Front Display Changes the brightness of the unit's display.	<ul style="list-style-type: none"> ● <u>Bright</u> ● <u>Dim</u> ● <u>Automatic</u>: The display turns dark during play, and reappears momentarily if a button is pressed. When the unit is turned off all displays disappear. While using this mode the standby power consumption can be reduced.
TV Screen	TV Type (⇒ page 12)	<ul style="list-style-type: none"> ● <u>Aspect 4:3 & 480i</u> ● <u>Aspect 16:9 & 480i</u> ● <u>Aspect 4:3 & 480P</u> ● <u>Aspect 16:9 & 480P</u>
	4:3 TV Settings for DVD-Video Select how DVD-Video widescreen picture is shown on a 4:3 standard aspect television.	<ul style="list-style-type: none"> ● <u>Pan & Scan</u>: Video recorded for a widescreen is played as Pan & Scan (unless prohibited by the producer of the disc). ● <u>Letterbox</u>: Video recorded for a widescreen is played in the letterbox style.
	4:3 TV Settings for DVD-RAM Select how DVD-RAM widescreen picture is shown on a 4:3 standard aspect television.	<ul style="list-style-type: none"> ● <u>4:3</u>: Titles played as recorded. ● <u>Pan & Scan</u>: Video recorded for a widescreen is played as Pan & Scan. ● <u>Letterbox</u>: Video recorded for a widescreen is played in the letterbox style.

Channel captions

You can use the preset captions, or manually enter new ones yourself.

The captions you enter are displayed when the channel is displayed and in the Direct Navigator screen.

- You can set channel captions only after “Auto Channel Setting” is completed.

1 Press [SETUP].

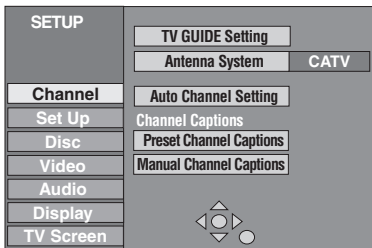

2 Press [▲, ▼] to select “Channel” and press [▶].

Preset Channel Captions

3 Press [▲, ▼] to select “Preset Channel Captions” and press [ENTER].

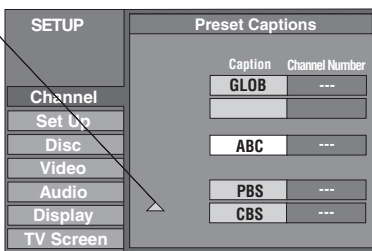

4 Press [▲, ▼] to select the caption and press [▶].

You can choose from the following captions.

ABC, PBS, CBS, CNN, FOX, ESPN, NBC, HBO, A&E, AMC, FAM, MAX, MTV, SHOW, TBS, USA, TNT, CBC, UPN, CTV, WB, TSN, DSC, GLOB

- When selecting the caption, press and hold [▲, ▼] to scroll up and down the screen.

5 Press [▲, ▼] to select the channel corresponding to the caption and press [◀].

- Channels are only displayed if they contain a station and if captions have not been added manually.
- To delete the channel number, press [* CANCEL].

Repeat steps 4 and 5 to enter other channels.

6 Press [ENTER].

3 Press [▲, ▼] to select “Manual Channel Captions” and press [ENTER].

4 Press [▲, ▼] to select the channel and press [▶].

- Channels are only displayed if they contain a station and if preset captions have not been added.

5 Press [▲, ▼] to select the first character and press [▶].

- You can choose from the following characters:
A–Z, 0–9, -, &, !, /, (space)
- To delete the caption, press [* CANCEL].
- Repeat this step to enter the other characters.

6 Press [◀, ▶] to return to the “Channel Number” column.

Repeat steps 4–6 to enter other channels.

7 Press [ENTER].

To exit the screen

Press [SETUP].

To return to the previous screen

Press [RETURN].

Specifications

Recording system: DVD Video Recording format (DVD-RAM)
DVD-Video format (DVD-R)

Recordable discs:
DVD-RAM :
12 cm (5") 4.7 GB, 12 cm (5") 9.4 GB, 8 cm (3") 2.8 GB
12 cm (5") 4.7 GB (Ver. 2.1/3×-SPEED DVD-RAM Revision 1.0)
DVD-R :
12 cm (5") 4.7 GB, 8cm (3") 1.4 GB (for General Ver. 2.0)
12 cm (5") 4.7 GB (for General Ver. 2.0/4×-SPEED DVD-R
Revision 1.0)

Recording time:
●Maximum 8 hours (with 4.7 GB disc)
XP: Approx. 1 hour SP: Approx. 2 hours
LP: Approx. 4 hours EP: Approx. 6 hours/8 hours
●Maximum 284 hours (with built-in 160 GB HDD)
XP: Approx. 36 hours SP: Approx. 70 hours
LP: Approx. 138 hours EP: Approx. 212 hours/284 hours

Playable discs:
DVD-RAM :
12 cm (5") 4.7 GB, 12 cm (5") 9.4 GB, 8 cm (3") 2.8 GB
12 cm (5") 4.7 GB (Ver. 2.1/3×-SPEED DVD-RAM Revision 1.0)
DVD-R :
12 cm (5") 4.7 GB, 8cm (3") 1.4 GB (for General Ver. 2.0)
12 cm (5") 4.7 GB (for General Ver. 2.0/4×-SPEED DVD-R
Revision 1.0)
DVD-Video, DVD-Audio, Video CD, CD-Audio (CD-DA)
CD-R/CD-RW (MP3, CD-DA, Video CD formatted discs)

Built-in HDD Capacity: 160 GB
Drive unit: High Speed Drive (correspond to 4 times speed with
DVD-R disc and 3 times speed with DVD-RAM disc)

LASER Specification
Class I LASER Product
Wave length:
795 nm wavelength (for CDs), 658 nm wavelength (for DVD)
Laser power:
No hazardous radiation is emitted with the safety protection

Audio system
Recording system:
Dolby Digital 2 ch, Linear PCM (XP mode, 2ch)
Input: LINE (pin jack)×3
Reference input: 309 mVrms, FS: 2 Vrms (1 kHz, 0 dB)
Input Impedance: 47 kΩ
Output: LINE (pin jack)×2
(Load impedance: 10 kΩ)
Reference output: 309 mVrms, FS: 2 Vrms (1 kHz, 0 dB)
Output Impedance: 1 kΩ
Digital Audio Out: Optical terminal (PCM, Dolby Digital, DTS)

Television system
Tuner system: NTSC-M
Antenna reception input: TV Channel: 2 ch-69 ch, 75 Ω
CATV Channel: 1 ch-125 ch, 75 Ω
RF Converter Output: Not provided

Video system
TV system: NTSC color signal, 525 lines, 60 fields
Recording system: MPEG2 (Hybrid VBR)
Input: LINE (pin jack)×3, 1.0 Vp-p; 75 Ω
S connector×3 Y: 1.0 Vp-p; C: 0.286 Vp-p; 75 Ω
Output: LINE (pin jack)×2, 1.0 Vp-p; 75 Ω
S connector×2 Y: 1.0 Vp-p; C: 0.286 Vp-p; 75 Ω
Component video output (480P/480I): Y: 1.0 Vp-p; 75 Ω
Pb: 0.7 Vp-p; 75 Ω
Pr: 0.7 Vp-p; 75 Ω

Card unit: Still picture (JPEG, TIFF)
Card slot: SD Memory Card/PC Card Type II
Compatible media: SD Memory Card, MultiMediaCard
A PC Card adaptor conforming to PC Card Standards,
ATA Flash PC Card,
PC Card adaptor (SD Memory Card, MultiMediaCard,
CompactFlash, SmartMedia, MEMORYSTICK, xD-Picture Card,
Microdrive), Mobile hard disk
Format: FAT12, FAT16
Image format: JPEG

DCF (Design rule for Camera File system),
(sub sampling 4:2:2 or 4:2:0),
TIFF (uncompressed RGB chunky),
DPOF Compatible
Number of pixels: 34×34 to 6144×4096
Thawing time: Approx. 7 sec. (2 M pixels)
DV input: IEEE 1394 Standard, 4 pin

Others
Regional code: # 1
Clock unit: Quartz-controlled 12-hour digital display
Operating temperature: 5 °C-40 °C (41 °F-104 °F)
Operating humidity range: 10 %-80 % RH (no condensation)
Power supply: AC 120 V, 60 Hz
Power consumption: 39 W
Dimensions (W×H×D): Approx. 430 mm×79 mm×291 mm
(Approx. 16¹⁵/₁₆"×3¹/₈"×11¹⁵/₃₂")
Mass: Approx. 4.5 kg (9.9 lbs)

Power consumption in standby mode: approx. 15 W

Note
Specifications are subject to change without notice.
Mass and dimensions are approximate.

User memo:

DATE OF PURCHASE _____
DEALER NAME _____
DEALER ADDRESS _____

TELEPHONE NUMBER _____

The model number and serial number of this product can be found on either the back or the bottom of the unit. Please note them in the space provided below and keep for future reference.

MODEL NUMBER _____ DMR-E95H _____
SERIAL NUMBER _____

Bitstream

This is the digital form of multi-channel audio data (e.g., 5.1 channel) before it is decoded into its various channels.

CPRM (Content Protection for Recordable Media)

CPRM is technology used to protect broadcasts that are allowed to be recorded only once. Such broadcasts can be recorded only with CPRM compatible recorders and discs.

Dolby Digital

This is a method of coding digital signals developed by Dolby Laboratories. Apart from stereo (2-channel) audio, these signals can also be multi-channel audio. A large amount of audio information can be recorded on one disc using this method.

When recording on this unit Dolby Digital (2 channel) is the default audio.

Down-mixing

This is the process of remixing the multi-channel audio found on some discs into two channels. It is useful when you want to listen to the 5.1-channel audio recorded on DVDs through your television's speakers. Some discs prohibit down-mixing and this unit can then only output the front two channels.

DPOF (Digital Print Order Format)

DPOF is the standard printing format for still picture data taken by a digital camera, etc. It is used for automatic printing at a photo developing store or on your home printer.

Drive

In the instance of this unit, this refers to the hard disk (HDD), disc (DVD), SD card (SD) and PC card (PC). These perform the reading and writing of data.

DTS (Digital Theater Systems)

This surround system is used in many movie theaters. There is good separation between the channels, so realistic sound effects are possible.

Dynamic range

Dynamic range is the difference between the lowest level of sound that can be heard above the noise of the equipment and the highest level of sound before distortion occurs.

Dynamic range compression means reducing the gap between the loudest and softest sounds. This means you can listen at low volumes but still hear dialog clearly.

Film and video

DVD-Video are recorded using either film or video. This unit can determine which type has been used, then uses the most suitable method of progressive output.

Film is 24 or 30 frames per second, with motion picture film generally being 24 frames per second.

Video is 60 fields per second (two fields making up one frame).

Finalize

A process that makes play of a recorded CD-R, CD-RW, DVD-R, etc. possible on equipment that can play such media. You can finalize DVD-R on this unit.

After finalizing, the disc becomes play-only and you can no longer record or edit.

Folder

This is a place on the hard disk or memory card where groups of data are stored together. In the case of this unit, it refers to the place where still pictures (JPEG, TIFF) are stored.

Formatting

Formatting is the process of making media such as DVD-RAM recordable on recording equipment.

You can format the HDD, DVD-RAM and memory cards on this unit. Formatting erases irrevocably all contents.

Frames and fields

Frames refer to the single images that constitute the video you see on your television. Each frame consists of two fields.

- A frame still shows two fields, so there may be some blurring, but picture quality is generally better.
- A field still shows less picture information so it may be rougher, but there is no blurring.

HDD (Hard disk drive)

This is a mass data storage device used in computers, etc. A disk with a surface that has been treated with magnetic fluid is spun and a magnetic head is brought in close proximity to facilitate the reading and writing of large amounts of data at high speed.

JPEG (Joint Photographic Experts Group)

Frequently asked questions

Set up		Page
What equipment is necessary to play multi channel surround sound?	<ul style="list-style-type: none"> ● DVD-Video: You can play DVD-Video multi channel surround by digitally connecting an amplifier equipped with a Dolby Digital and a DTS decoder. ● DVD-Audio: This unit plays DVD-Audio in 2 channels. You cannot play multi channel surround sound. 	9 —
Are the headphones and speakers directly connected to the unit?	<ul style="list-style-type: none"> ● You cannot directly connect to the unit. Connect through the amplifier, etc. 	9
The television has both S-VIDEO IN terminal and COMPONENT VIDEO IN terminals. Which terminal should I connect with?	<ul style="list-style-type: none"> ● We recommend the COMPONENT VIDEO IN terminal. Component signal outputs the color difference signals (P_B/P_R) and luminance signal (Y) separately in order to achieve high fidelity in reproducing colors. If the television is compatible with progressive output, a high quality picture can be output because this unit's component video output terminal outputs a progressive output signal. 	7
Is my television progressive output compatible?	<ul style="list-style-type: none"> ● All Panasonic televisions that have 480P input terminals are compatible. Consult the manufacturer if you have another brand of television. 	—

Disc		
Can I play DVD-Video, DVD-Audio and Video CDs bought in another country?	<ul style="list-style-type: none"> ● You can play them if the video standard is NTSC. ● However, you cannot play DVD-Video if their region number does not include "1" or "ALL". 	— Cover
Can a DVD-Video that does not have a region number be played?	<ul style="list-style-type: none"> ● The DVD-Video region number indicates the disc conforms to a standard. You cannot play discs that do not have a region number. 	—
Please tell me about DVD-R and DVD-RW compatibility with this unit.	<ul style="list-style-type: none"> ● This unit records and plays DVD-R. However, you cannot record onto DVD-R discs that are finalized. ● This unit also records and plays high speed recording compatible discs. ● This unit does not record or play DVD-RW. 	— — —
Please tell me about CD-R and CD-RW compatibility with this unit.	<ul style="list-style-type: none"> ● This unit plays CD-R/CD-RW discs (audio recording discs) which have been recorded under one of the following standards: CD-DA, MP3 and Video CD. Close the session or finalize the disc after recording. ● You cannot write to a CD-R or CD-RW with this unit. 	14, 27 —

Recording		
Can I record from a commercially purchased video cassette or DVD?	<ul style="list-style-type: none"> ● Most commercially sold video cassettes and DVD are copy protected; therefore, recording is usually not possible. 	—
Can a DVD-R recorded on this unit be played on other equipment?	<ul style="list-style-type: none"> ● You can play on DVD-R compatible players after finalizing the disc on this unit; however, due to the condition of the recording, play may not be possible. 	45
How many times can I write to a DVD-RAM disc?	<ul style="list-style-type: none"> ● You can write to the disc approximately 100,000 times depending upon the conditions of use. 	—
Can I high speed transfer (dub) to a disc?	<ul style="list-style-type: none"> ● You can record up to 32× recording speed to DVD-R and up to 24× recording speed to DVD-RAM when using a high speed compatible disc. 	37
Can I record digital audio signals using this unit?	<ul style="list-style-type: none"> ● You cannot record digital signals. The digital audio terminals on this unit are for output only. (The audio recorded using the DV automatic recording function from a digital video camcorder, for example, is recorded digitally.) 	—
Can a digital audio signal from this unit be recorded to other equipment?	<ul style="list-style-type: none"> ● You can record if using the PCM signal. When recording DVD, change the "Digital Audio Output" settings to the following from the SETUP menu. —PCM Down Conversion On —Dolby Digital PCM —DTS PCM However, only —As long as digital recording from the disc is permitted. —As long as the recording equipment is compatible with a sampling frequency of 48 kHz. ● You cannot record MP3 signals. 	49 —
Can I switch to SAP during recording?	<ul style="list-style-type: none"> ● With HDD and DVD-RAM, you can, and the audio recorded also changes. Just press [AUDIO]. ● With DVD-R, you cannot. Change before recording with "Select MTS" in the SETUP menu. 	17 48

TV Guide On Screen™ system		
I do not want TV Guide On Screen™ system to automatically appear on screen.	<ul style="list-style-type: none"> ● Select "Off" in "Review options" menu, so that TV Guide On Screen™ system appears only when you press [TV GUIDE]. 	23
I do not want to use TV Guide On Screen™ system.	<ul style="list-style-type: none"> ● Set the unit with "Auto Channel Setting". Note that you can set timer recording only manually after you set the unit with "Auto Channel Setting". 	50

Error messages

On the television

		Page
Cannot finish recording completely.	•The program was copy-protected.	—
Cannot play.	•The HDD or disc may be full.	—
Cannot record on the disc. Please check the disc.	•You inserted an incompatible disc (Discs recorded in PAL video, etc.).	—
Unable to format.	•The disc may be dirty or scratched.	60
Cannot play back on this DVD-Recorder.	•You cannot format a Microdrive or mobile hard disk on this unit.	—
Cannot record. Disc is full.	•You tried to play a non-compatible image.	28
Cannot record. Maximum number of titles exceeded.	•Turn the unit off and re-insert the card.	28
Error has occurred. Please press ENTER.	•Create space by erasing any unnecessary titles. HDD RAM (Even if you erase recorded content from the DVD-R, there is no increase in disc space.)	26, 33, 44, 45
	•Use a new disc.	—
	•Press [ENTER] to start recovery process. You cannot operate the unit while it is recoveris vtD 0.0041 Tcv EEoou can (i) 1	—

On the unit's display

Troubleshooting guide

Before requesting service, make the following checks. If you are in doubt about some of the check points, or if the remedies indicated in the chart do not solve the problem, refer to the "Customer Services Directory" on page 61.

The following do not indicate a problem with this unit:

- | | |
|---|---|
| <ul style="list-style-type: none"> ●Regular disc rotating sounds. ●Poor reception due to atmospheric conditions. ●Image disturbance during search. | <ul style="list-style-type: none"> ●Interruptions in reception due to periodic satellite broadcasting breaks. ●A sound is heard when the HDD goes into SLEEP mode, or operations are slow to respond in SLEEP mode. |
|---|---|

Power

		Page
No power.	●Insert the AC power supply cord securely into a known active AC outlet.	7
The unit switches to standby mode.	<ul style="list-style-type: none"> ●This is a power saving feature. Change "Off Timer" in the SETUP menu, if you would prefer. ●One of the unit's safety devices is activated. Press [POWER ⏻/I] on the main unit to turn the unit on. 	47 —

Displays

The display is dim.	●Change "Front Display" in the SETUP menu.	49
"12:00" is flashing on the unit's display.	●Set the clock.	11
Compared to the actual recorded time, the remaining time displayed is less.	●The displayed recording/play time is converted from the number of frames at 29.97 frames (equal to 0.999 seconds) to one second. There will be a slight difference between the time displayed and the actual elapsed time (e.g., actual one-hour elapsed time may display as approximately 59 minutes 56 seconds). This does not affect the recording.	—
The time recorded on the disc and the available time shown do not add up.	<ul style="list-style-type: none"> ●Times shown may disagree with actual times. ●More disc space than the actual recording time is used after recording or editing the DVD-R 200 times or more. 	— —
The play time shown for MP3 does not agree with the actual time.	<ul style="list-style-type: none"> ●While searching, the elapsed time may not display correctly. ●Even if you erase recorded content from the DVD-R, there is no increase in disc space. 	— —

TV screen and video

Television reception worsens after connecting the unit.	●This can occur because the signals are being divided between the unit and other equipment. It can be solved by using a signal booster, available from audio-visual suppliers.	—
Status messages do not appear.	●Select "Automatic" in "Status Messages" in the SETUP menu.	49
The blue background does not appear.	●Select "On" in "Blue Background" in the SETUP menu.	49
The 4:3 aspect ratio picture expands left and right.	<ul style="list-style-type: none"> ●Use the television to change the aspect. If your television does not have that function, set "Progressive" in the Video menu to "OFF". ●Check the settings for "TV Type", "4:3 TV Settings for DVD-Video" or "4:3 TV Settings for DVD-RAM" in the SETUP menu. 	31 49
Screen size is wrong.		
There is a lot of after-image when playing video.	●Change the settings for "3D NR", and "Integrated DNR" to "0" or turn "MPEG-DNR" off if it is on.	31
When playing DVD-Video using progressive output, one part of the picture momentarily appears to be doubled up.	●Set "Progressive" in the Video menu to "OFF". This problem is caused by the editing method or material used on DVD-Video, but should be corrected if you use interlace output.	31
There is no apparent change in picture quality when adjusted with the Video menu in the on-screen menus.	●The effect is less perceivable with some types of video.	—
The images from this unit do not appear on the television.	<ul style="list-style-type: none"> ●Make sure that the television is connected to the VIDEO OUT terminal, S-VIDEO OUT terminal or COMPONENT VIDEO OUT terminals on this unit. ●Make sure that the television's input setting (e.g., VIDEO 1) is correct. 	7 —
Picture is distorted.	●The television isn't compatible with progressive signals. Press and hold [■] and [TIME SLIP] on the main unit at the same time for about 5 seconds. The setting will change to interlace.	—

Sound

Page

No sound. Low volume. Distorted sound. Cannot hear the desired audio type.	<ul style="list-style-type: none"> • Check the connections and settings. Check the input mode on the amplifier if you have connected one. • Press [AUDIO] to select the audio. • Turn off V.S.S. in the following cases. <ul style="list-style-type: none"> – When using discs that do not have surround sound effects such as Karaoke discs. – When playing MTS broadcast programs. • The disc may have a restriction on the method of audio output. If “D.MIX” does not appear in the display when playing multi-channel DVD-Audio, only audio for the two front channels will be output. Refer to the disc’s jacket. DVD-A 	<p>7–9, 49</p> <p>17, 26 31</p> <p>—</p>
	Cannot switch audio.	<ul style="list-style-type: none"> • You cannot switch the audio in the following cases. <ul style="list-style-type: none"> – When a DVD-R disc is in the disc tray while DVD drive is selected. – When the recording mode is XP and “Audio for XP Recording” is set to “LPCM”. – When “DVD-R High-Speed Recording” is set to “On” • You have used digital connection. Set “Dolby Digital” to “PCM” or connect using audio cables (analog connection). • There are discs for which audio cannot be changed because of how the disc was created.

Operation

Cannot operate the television. The remote control doesn’t work.	<ul style="list-style-type: none"> • Change manufacturer code. Some televisions cannot be operated even if you change the code. • The remote control and main unit are using different codes. Change the code on the remote control. 	<p>12</p> <p>13</p>
	 <p>Press and hold [ENTER] and the indicated number button at the same time for more than 2 seconds.</p>	
	<ul style="list-style-type: none"> • The batteries are depleted. Replace them with new ones. • Colored glass may obstruct the signal reception/transmission. • Don’t place the signal sensor in direct sunlight or in areas that may be subject to sunlight exposure. 	<p>4</p> <p>—</p> <p>—</p>
	<ul style="list-style-type: none"> • Recording drive or playback drive has not been selected properly. • Some operations may be prohibited by the disc. • The unit is hot (“U14” appears on the display). Wait for “U14” to disappear. • One of the unit’s safety devices may have been activated. <p>Reset the unit as follows: Press [POWER ⏻/I] on the main unit to switch the unit to standby. If the unit doesn’t switch to standby, press and hold [POWER ⏻/I] on the main unit for about 10 seconds. The unit is forcibly switched to standby. Alternatively, disconnect the AC power supply cord, wait one minute, then reconnect it.</p>	<p>16, 24</p> <p>—</p> <p>—</p> <p>—</p>
HDD activation is slow.	<ul style="list-style-type: none"> • The HDD is in SLEEP mode. (“HDD SLP” appears in the unit’s display.) 	<p>60</p>
Cannot eject disc.	<ul style="list-style-type: none"> • The unit may have a problem. While the unit is off, press and hold [■] and [CH ^] on the main unit at the same time for about 5 seconds. Remove the disc and consult the dealer. 	<p>—</p>

Recording/Timer recording/Transferring (dubbing)

Cannot record.	<ul style="list-style-type: none"> • You haven’t inserted a disc or the disc you inserted cannot be recorded on. Insert a disc the unit can record onto. • The disc is unformatted. Format the disc. RAM • The write-protect tab on the cartridge is set to PROTECT, or the disc is protected with DISC SETTING. • Some programs have limitations on the number of times they can be recorded. (CPRM) • You cannot record when there is not enough space or when the number of titles has reached its limit. Erase unwanted titles. • You cannot record on finalized DVD-R discs. • Due to peculiarities of DVD-R, you may be unable to record onto them if you either insert and remove the disc or switch the unit on and off while a disc is loaded, a total of fifty times. • A DVD-R recorded on this unit may not be recordable on other Panasonic DVD recorders. 	<p>14</p> <p>45</p> <p>44</p> <p>53</p> <p>26, 33, 44, 45</p> <p>—</p> <p>—</p> <p>—</p>	
	Timer recording does not work properly.	<ul style="list-style-type: none"> • The timer program is incorrect or different timer program times overlap. Correct the program. • Timer recording program may be deleted if there is an interruption to the power. • VCR Plus+ system works only after this unit downloads the television program list. 	<p>22</p> <p>—</p> <p>—</p>
	VCR Plus+ system does not work properly.		
	Timer recording does not stop even when [■] is pressed.	<ul style="list-style-type: none"> • Press [■] and then [ENTER] within 5 seconds. Recording stops. 	<p>19, 20, 21</p>
	The timer program remains even after recording finishes.	<ul style="list-style-type: none"> • The timer program remains unless set to “Once”. 	<p>19, 20</p>
	A part or whole of a recorded title has been lost.	<ul style="list-style-type: none"> • If there is a power failure or the plug is disconnected from the household AC outlet while recording or editing, the title may be lost or the HDD/disc may become unusable. You will have to format the disc (HDD RAM) or use a new disc. We cannot offer any guarantee regarding lost titles or discs. 	<p>45</p>

Continued on next page

	automatic recording may not operate properly.	—
TV Guide On Screen™ system		
Television program list does not display when [TV GUIDE] is pressed.	TV Guide On Screen™ system again. are using a cable TV box. in your area. Set the unit using “Auto Channel Setting”. ording manually after you set the unit using “Auto	— 7, 8, 10 — 50
“Cable code -INCOMPLETE-” appears in the TV Guide On Screen™ system setup.	ode for the cable TV box. Consult your service provider.	—
As soon as the unit is turned on, and when you try to start timer recording, the TV Guide On Screen™ system setup begins.	TV Guide On Screen™ system, you need to complete the (until [ENTER] is pressed after the “Watch TV” not be displayed after this point.	10
Several days of television program listings are blank.	ere are several days of blank listings. You can display without any blank listings by downloading program lists	—
Channel changes even when no operation is performed.	TV box, the cable TV box channel changes while the the television program list.	—
Play		
Play fails to start even when [▶] (PLAY) is pressed. Play starts but then stops immediately.	acing up. VD-R, or disc unplayable on this unit. One time only recording” title that was recorded to DVD- Recorder to this unit’s HDD, but play is not possible	24 14 —
Audio and video momentarily pause.	P (8H) mode, play may not be possible on DVD players in this case use EP (6H) mode. omatic recording.	48 —
DVD-Video is not played.	s. h partially deleted titles on finalized DVD-R that have igh speed mode.	— —
Alternative soundtrack and subtitles cannot be selected.	hen you change the ratings level.	48
No subtitles.	disc. to select languages.	— —
Angle cannot be changed.	captions cannot be displayed.	— — 30
You have forgotten your ratings password.	enes where different angles are recorded.	—
Quick View does not work.	[D] then press and hold [◀◀/◀◀] and [▶▶/▶▶] on more seconds.	—
The resume play function does not work.	” in “Search Audio & PLAY ×1.3”. er than Dolby Digital. n XP or FR mode. RAM is flashing on the unit display. hen the unit is turned off or when the tray is opened. The also canceled when the play list and title are edited.	48 — — — —

Edit		Page
Cannot format.	●The disc is dirty. Use a special cleaner and wipe clean.	60
	●You tried formatting a disc that is not compatible with this unit.	14
Cannot create chapters.	●The unit writes the chapter division information to the disc when you turn it off or remove the disc. The information is not written if there is an interruption to the power before this.	—
Cannot mark the start point or the end point during “Shorten” operation.	●These operations are not possible with still pictures.	—
	●You cannot set points if they are too close to each other. You cannot set an end point before a start point.	—
Cannot erase chapters.	●When the chapter is too short to erase, use “Combine Chapters” to make the chapter longer.	33
The available recording time doesn’t increase even after erasing recordings on the disc.	●Available recording space on the DVD-R does not increase even after erasing previously recorded titles.	—
Cannot create a play list.	●You cannot select all the chapters at once in a title if the title also includes still pictures. Select them individually.	—

Still pictures

Cannot display Direct Navigator screen.	●This screen cannot be displayed during recording or transfer (dubbing) or while the unit is standing by for linked timer recording with external equipment.	—
Cannot edit or format a card.	●Release the card’s protection setting. (With some cards, the “Write protection Off” message sometimes appears on the screen even when protection has been set.)	44
The contents of the card cannot be read.	●The card format is not compatible with the unit. (The contents on the card may be damaged.) Format using FAT 12 or FAT 16 with other equipment or format the card with this unit.	15, 28
	●The card contains a folder structure and/or file extensions that are not compatible with this unit.	45
	●Turn off and then turn on the unit again.	15
		—
Recording (dubbing), setting protection time.	●When there are a lot of folders and files, it may sometimes take a few hours. ●When repeating transferring (dubbing) or erasing, it may sometimes take a long time. Format the disc or card.	— 45
Card cannot be removed.	●Make sure the PC card is slotted home firmly before attempting to remove.	28
Recording cannot be stopped in the middle.	●If it comes to the time scheduled for timer recording, the recording may start even though you are editing.	—

Service

The unit should be serviced by qualified service personnel if:

- the video adaptor has been damaged; or
- the unit; or

or

- the unit exhibits a marked change in performance; or
- the unit has been damaged.

Do not attempt to service the unit beyond that described in these operating instructions. Refer all other servicing to authorized service centers.

When having the unit serviced, please ensure the servicer uses parts specified by the manufacturer or parts that have the same specifications. The use of unauthorized substitutes may result in fire, electric shock, or other hazards.

After servicing, please have the servicer perform safety checks to confirm that the unit is in proper working condition.

Unit care

The precision parts in this unit are readily affected by the environment, especially temperature, humidity, and dust. Cigarette smoke also can cause malfunction or breakdown.

To clean this unit, wipe with a soft, dry cloth.

- Never use alcohol, paint thinner or benzine to clean this unit.
- Before using chemically treated cloth, read the instructions that came with the cloth carefully.

Observe the following points to ensure continued listening and viewing pleasure.

Dust and dirt may adhere to the unit's lens over time, making it impossible to record or play discs.

Use the DVD-RAM/PD lens cleaner (LF-K123LCA1, where available) about once every year, depending on frequency of use and the operating environment. Read the lens cleaner's instructions carefully before use.

Disc and card handling

How to hold a disc or card

Do not touch the recorded surface or the terminal surface.



If there is dirt or condensation on the disc

RAM DVD-R

- Clean with an optional DVD-RAM/PD disc cleaner (LF-K200DCA1, where available).
- Do not use cleaners for CDs or cloths.

DVD-A DVD-V VCD CD

Wipe with a damp cloth and then wipe dry.



Handling precautions

- Do not attach labels or stickers to discs. (This may cause disc warping and un-balanced rotation, rendering it unusable.)
- Do not write on the label side with a ball-point pen or other writing instrument.
- Do not use record cleaning sprays, benzine, thinner, static electricity prevention liquids or any other solvent.
- Do not use scratch-proof protectors or covers.
- Do not expose the terminals of the card to water, garbage or other strange things.
- Do not use the following discs:
 - Discs with exposed adhesive from removed stickers or labels (rented discs, etc).
 - Discs that are badly warped or cracked.
 - Irregularly shaped discs, such as heart shapes.
- Do not place in the following areas:
 - In direct sunlight.
 - In very dusty or humid areas.
 - Near a heater.
 - Where static electricity or electromagnetic waves occur



HDD (Hard disk drive) handling care

The HDD is a high precision recording instrument and because of its long recording capability and high speed operation it is a very special device that is easily susceptible to damage.

As a basic rule, save important video content to a DVD disc as backup.

The HDD is a device that is not built to withstand vibration/shock or dust

Depending on the setup environment and handling of the HDD some content may become damaged and play and recording may no longer be possible. Especially during operation, do not subject the unit to any vibration, shock, or remove the AC power plug from the household AC outlet. In the event of a power failure the content, during recording or play, may be damaged.

The HDD is a temporary storage device

The HDD is not an everlasting storage device for recorded content. Use the HDD as a temporary storage place for viewing once, editing, or for saving to a DVD disc.

Immediately save (backup) all content as soon as you feel there may be problem with the HDD

If there is an irregularity within the HDD, strange sounds or problems with picture (block noise, etc.) may result. Using the HDD in this condition may worsen the problem and in the worst case the HDD

may no longer become usable. As soon as you notice this type of problem, save all content to the DVD disc.

Recorded content (data) on an HDD that has become unusable is unrecoverable.

Setup precautions

- Do not place in an enclosed area so the rear cooling fan and the cooling vents on the side are covered up.
- Place the unit on a surface that is flat and not subject to vibration or impact.

- Do not place on anything that generates heat like a video cassette recorder, etc.



- Do not place in an area often subject to temperature changes.
- Do not place in an area where condensation does not occur. Condensation is a phenomenon where moisture forms on a cold surface when there is an extreme change in temperature. Condensation may cause internal damage to the unit.

Conditions where condensation may occur

- When there is an extreme change in temperature (moving from a very hot location to a very cold location, or vice versa, or when subjected to an air conditioner or when cooled air directly impacts the unit.) When the HDD (warms during operation) is subjected to cold air, condensation may form on the inside of the HDD and may cause damage to the HDD heads, etc.
- When there is high humidity or a lot of steam in the room.
- During the rainy season.

- In the above situation, **without turning the unit on**, let the unit adjust to the room temperature and wait 2–3 hours until condensation is gone.

Cigarette smoke, etc. causes malfunction or breakdown

The unit may breakdown if cigarette smoke or bug spray/vapor, etc. gets inside the unit.

While operating

- Do not move the unit or subject to vibration or impact. (The HDD may become damaged.)
 - Do not remove the AC power plug from the household AC outlet, or flip the power breaker switch.
- While the unit is on, the HDD is rotating at high speed. Sound or movement due to rotation is normal.

When moving the unit

- ① Turn the unit off. (Wait until "BYE" disappears from the display.)
- ② Remove the AC power plug from the household AC outlet.
- ③ Move only after the unit has come to a complete stop (approx. 2 minutes) in order to avoid subjecting to vibration and shock. (Even after turning the unit off, the HDD continues operating for a short time.)

HDD recording time remaining

This unit records using a VBR (Variable bit rate) data compression system to vary recorded data segments to match video data segments which may cause differences in the displayed amount of time and space remaining for recording.

If the remaining amount of time is insufficient, erase any unwanted titles to create enough space before you start recording. (Erasing a play list will not increase the amount of time.)

When "HDD SLP (SLEEP)" appears in the display

The HDD has been automatically placed in the SLEEP mode. (The HDD continues to rotate at high speed while the unit is on. In order to extend the life of the HDD, the HDD will be placed in the SLEEP mode if no operation has been performed for 30 minutes while there is no disc on the disc tray.)

- Press [HDD] to activate.
- While in SLEEP mode play or recording may not begin right away because the HDD takes time to be re-activated.
- When not using the unit, we recommend removing the disc in the tray in order to set the HDD to the SLEEP mode.

Indemnity concerning recorded content

Panasonic does not accept any responsibility for damages directly or indirectly due to any type of problems that result in loss of recording or edited content (data), and does not guarantee any content if recording or editing does not work properly. Likewise, the above also applies in a case where any type of repair is made to the unit (including any other non-HDD related component).

Limited Warranty

Panasonic Consumer Electronics Company,
Division of Matsushita Electric Corporation of America
One Panasonic Way Secaucus, New Jersey 07094

Panasonic Sales Company, Division of Matsushita Electric
of Puerto Rico, Inc.,
Ave. 65 de Infantería, Km. 9.5
San Gabriel Industrial Park, Carolina, Puerto Rico 00985

Panasonic DVD Recorder Limited Warranty

Limited Warranty Coverage

If your product does not work properly because of a defect in materials or workmanship, Panasonic Consumer Electronics Company or Panasonic Sales Company (collectively referred to as "the warrantor") will, for the length of the period indicated on the chart below, which starts with the date of original purchase ("warranty period"), at its option either (a) repair your product with new or refurbished parts, or (b) replace it with a new or a refurbished product. The decision to repair or replace will be made by the warrantor.

Product or Part Name	Parts	Labor
DVD Recorder	One (1) Year	One (1) Year
Rechargeable Batteries, DVD-RAM Disc (in exchange for defective item)	Ten (10) Days	Not Applicable

During the "Labor" warranty period there will be no charge for labor. During the "Parts" warranty period, there will be no charge for parts. You must carry-in or mail-in your product during the warranty period. If non-rechargeable batteries are included, they are not warranted. This warranty only applies to products purchased and serviced in the United States or Puerto Rico. This warranty is extended only to the original purchaser of a new product which was not sold "as is". A purchase receipt or other proof of the original purchase date is required for warranty service.

Carry-In or Mail-In Service

For Carry-In or Mail-In Service in the United States call 1-800-211-PANA (7262) or visit Panasonic Web Site: <http://www.panasonic.com>
For assistance in Puerto Rico call Panasonic Sales Company (787)-750-4300 or fax (787)-768-2910.

Limited Warranty Limits And Exclusions

This warranty ONLY COVERS failures due to defects in materials or workmanship, and DOES NOT COVER normal wear and tear or cosmetic damage. The warranty ALSO DOES NOT COVER damages which occurred in shipment, or failures which are caused by products not supplied by the warrantor, or failures which result from accidents, misuse, abuse, neglect, mishandling, misapplication, alteration, faulty installation, set-up adjustments, misadjustment of consumer controls, improper maintenance, power line surge, lightning damage, modification, or commercial use (such as in a hotel, office, restaurant, or other business), rental use of the product, service by anyone other than a Factory Servicenter or other Authorized Servicer, or damage that is attributable to acts of God.

THERE ARE NO EXPRESS WARRANTIES EXCEPT AS LISTED UNDER "LIMITED WARRANTY COVERAGE". THE WARRANTOR IS NOT LIABLE FOR INCIDENTAL OR CONSEQUENTIAL DAMAGES RESULTING FROM THE USE OF THIS PRODUCT, OR ARISING OUT OF ANY BREACH OF THIS WARRANTY. (As examples, this excludes damages for lost time, travel to and from the servicer, loss of media or images, data or other recorded content. The items listed are not exclusive, but are for illustration only.) **ALL EXPRESS AND IMPLIED WARRANTIES, INCLUDING THE WARRANTY OF MERCHANTABILITY, ARE LIMITED TO THE PERIOD OF THE LIMITED WARRANTY.**

Some states do not allow the exclusion or limitation of incidental or consequential damages, or limitations on how long an implied warranty lasts, so the exclusions may not apply to you.

This warranty gives you specific legal rights and you may also have other rights which vary from state to state. If a problem with this product develops during or after the warranty period, you may contact your dealer or Servicenter. If the problem is not handled to your satisfaction, then write to the warrantor's Consumer Affairs Department at the addresses listed for the warrantor.

PARTS AND SERVICE WHICH ARE NOT COVERED BY THIS LIMITED WARRANTY ARE YOUR RESPONSIBILITY.

Customer Services Directory

Obtain Product Information and Operating Assistance; locate your nearest Dealer or Servicenter; purchase Parts and Accessories; or make Customer Service and Literature requests by visiting our Web Site at:

<http://www.panasonic.com/support>

or, contact us via the web at:

<http://www.panasonic.com/contactinfo>

You may also contact us directly at:

1-800-211-PANA (7262),

Monday-Friday 9 am-9 pm; Saturday-Sunday 10 am-7 pm, EST.

For hearing or speech impaired TTY users, TTY : 1-877-833-8855

Accessory Purchases

Purchase Parts, Accessories and Instruction Books online for all Panasonic Products by visiting our Web Site at:

<http://www.pasc.panasonic.com>

or, send your request by E-mail to:

npcparts@panasonic.com

You may also contact us directly at:

1-800-332-5368 (Phone) 1-800-237-9080 (Fax Only) (Monday - Friday 9 am to 8 pm, EST.)

Panasonic Services Company

20421 84th Avenue South, Kent, WA 98032

(We Accept Visa, MasterCard, Discover Card, American Express, and Personal Checks)

For hearing or speech impaired TTY users, TTY : 1-866-605-1277

Service in Puerto Rico

Matsushita Electric of Puerto Rico, Inc. Panasonic Sales Company

Factory Servicenter:

Ave. 65 de Infantería, Km. 9.5, San Gabriel Industrial Park, Carolina, Puerto Rico 00985

Phone (787)750-4300, Fax (787)768-2910

Conexión de un televisor y videograbadora

Consulte la ilustración que aparece en la página 7 de la sección en idioma inglés.

- Las conexiones del equipo descritas son ejemplos.
- Antes de hacer la conexión, apague todos los equipos y lea los manuales de instrucciones apropiados.
- El equipo periférico y los cables opcionales se venden por separado a menos que se indique lo contrario.

(A)	<p>— indica accesorios incluidos. - - - indica accesorios no incluidos. ❶ - ❹ son conexiones necesarias. Conecte siguiendo el orden numerado.</p>
(B)	Televisión
(C)	Cuando haga esta conexión, asegúrese de conectar los cables de audio a los terminales de entrada de audio correspondientes del televisor.
(D)	TV por cable
(E)	Antena exterior
(F)	Antena interior
(G)	Cable de alimentación de CA Conecte solamente después de haber terminado todas las otras conexiones.
(H)	Rojo Blanco Amarillo
(I)	A una toma de CA de casa (CA 120 V, 60 Hz)
(J)	Cable coaxial de 75 Ω ⇒ abajo
(K)	Cable de antena
(L)	A la antena
(M)	Cable de audio/vídeo
(N)	Cable de S-Vídeo
(O)	Cable de vídeo componente
(P)	Divisor
(Q)	A OUT1 o OUT2
(R)	Ventilador de refrigeración
(S)	A IN1 (L1)
(T)	Esta unidad
(U)	Terminal S-VIDEO OUT El terminal S-VIDEO OUT proporciona una imagen más viva que la del terminal VIDEO OUT. (Los resultados reales dependen del televisor.)
(V)	Utilice un divisor si también quiere conectar la antena a su videograbadora.
(W)	Terminal COMPONENT VIDEO OUT Estos terminales se pueden utilizar para la salida entrelazada o progresiva y para proporcionar una imagen más pura que la del terminal S-VIDEO OUT. • Conecte a los terminales del mismo color.
(X)	Videograbadora

■ Cable coaxial de 75 Ω

La señal de imagen y sonido procedente de este aparato no pasa a través del cable coaxial de 75 Ω al televisor. Asegúrese de conectar uno de los terminales siguientes de este aparato al televisor: el terminal AUDIO/VIDEO OUT, el terminal S-VIDEO OUT o el terminal COMPONENT VIDEO OUT. Si el televisor no tiene ninguno de estos terminales, consulte a su concesionario local.

■ No conecte la unidad a través de una videograbadora

Las señales de vídeo que pasan a través de videograbadoras afectarán a los sistemas de protección del copyright, y la imagen no se mostrará correctamente en el televisor.

- Cuando conecte a un televisor con videograbadora incorporada, conecte a los terminales de entrada del televisor, no a los de la videograbadora.

Conexión de un receptor de TV por cable

Consulte la ilustración que aparece en la página 8 de la sección en idioma inglés.

- Necesita suscribirse a los servicios de TV por cable para ver su programación.
- Consulte a su proveedor de servicios en cuanto al receptor de TV por cable apropiado.
- **Si recibe únicamente su programación de un servicio de satélite, la guía de programas de esta unidad no recibirá las listas de programas ni la información de los canales. Sin esta información no se podrán hacer grabaciones basadas en programas. Sin embargo, sí se podrán hacer grabaciones manualmente.**

(A)	Televisión
(B)	Esta unidad
(C)	Cable de audio/vídeo*
(D)	Cable coaxial de 75 Ω*
(E)	IR Blaster Introduzca el conector IR Blaster en el terminal G-LINK. El receptor de TV por cable está controlado por una señal IR transmitida a través del IR Blaster. Cuando seleccione canales en esta unidad, los canales correspondientes del receptor de TV por cable también cambiarán en conformidad. • Utilice solamente el IR Blaster suministrado.
(F)	Use IN3 (L3) [no IN1 (L1)].
(G)	Rojo Blanco Amarillo
(H)	Conecte al terminal RF IN o IN3 (L3) de esta unidad.
(I)	Cable de S-Vídeo
(J)	Ajuste del IR Blaster ⇒ más abajo
(K)	Receptor de TV por cable
(L)	De la antena o toma de TV por cable

* Para más información de las conexiones (⇒ izquierda)

■ ¿Debo usar el terminal AUDIO/VIDEO OUT o el RF OUT?

Si su receptor de TV por cable tiene terminales AUDIO/VIDEO OUT y RF OUT, le recomendamos conectar el terminal AUDIO/VIDEO OUT al terminal IN3 (L3) de la unidad. Esta conexión proporciona la mejor calidad de imagen.

- El terminal S-VIDEO proporciona una imagen más viva que la del terminal VIDEO.

Ajuste del IR Blaster

Coloque el IR Blaster delante del sensor de señales del receptor de TV por cable.

(M)	Lea las instrucciones del receptor de TV por cable relacionadas con la posición del sensor de señales.
(N)	Si es necesario, utilice cinta con adhesivo en ambas caras (incluida) para asegurar el IR Blaster a una superficie plana.
(O)	Ej. Superficie de base de televisión
(P)	Receptor de TV por cable
(Q)	Si despegas la cinta adhesiva, la superficie podrá dañarse. Después de confirmar que el receptor de TV por cable esté funcionando correctamente, asegúrelo empleando la cinta adhesiva.

Preparación del sistema de guía de TV en pantalla

Consulte la ilustración que aparece en la página 10 de la sección en idioma inglés.

Después de enchufar la unidad en una toma de CA de casa y pulsar [⏻ DVD POWER] para encender la unidad por primera vez, ésta inicia la preparación del sistema de guía de TV en pantalla.

En el sistema de guía de TV en pantalla sólo se muestra inglés. No se pueden mostrar otros idiomas.

Preparación

● Encienda el televisor y seleccione la entrada de vídeo apropiada a las conexiones de esta unidad.

● Cuando use el receptor de TV por cable, compruebe lo siguiente.
– Asegúrese de que IR Blaster esté conectado y posicionado correctamente (► páginas 8, 62).
– Asegúrese de que el receptor de TV por cable esté encendido.

① Pulse [⏻ DVD POWER].

② Prepare el entorno de funcionamiento de su televisor siguiendo los mensajes de la pantalla.

- Mueva el cursor con [▲, ▼, ◀, ▶] y pulse [ENTER] para confirmar.
- Pulse los botones numerados para introducir números.
- Pulse [ENTER] para avanzar a la pantalla siguiente.
- Consulte las indicaciones de la parte inferior de la pantalla.

Ajuste lo siguiente:

- País (USA (EE.UU.)/Canada (Canadá))
- Código postal
- Servicio de TV por cable conectado a esta unidad [Yes (Sí)/No (No)]
- Receptor de TV por cable conectado a esta unidad [Yes (Sí)/No (No)]

Si está usando un receptor de TV por cable, ajuste lo siguiente:

- Canales de conexión del receptor de TV por cable (Ch2/Ch3/Ch4/L3)
- Marca del receptor de TV por cable
- Código de señal IR

Asegúrese de que su receptor de TV por cable sintonice el canal que aparece en la pantalla y pulse [ENTER]. Se hace una prueba.

– Si el receptor de TV por cable ha cambiado al canal 09, seleccione “Yes (Sí)” y pulse [ENTER].

– Si el receptor de TV por cable sigue sintonizado al mismo canal, seleccione “No (No)” y pulse [ENTER]. Repita este paso hasta que el receptor de TV por cable cambie al canal 09.

El contenido ajustado se visualiza junto

Zip code - 11111 (USA)
Cable - Yes
Cable box - No

– Si la información es correcta, seleccione “Yes, end setup (Sí, finalice la preparación)” y pulse [ENTER].

– Si la información no es correcta, seleccione “No, repeat setup process (No, repita el proceso de preparación)” y pulse [ENTER] para iniciar de nuevo el ajuste.

Una vez confirmado el contenido introducido aparece la pantalla siguiente.

What would you like to do now?

Watch TV

③ Pulse [ENTER].

Se muestra una pantalla de recepción de televisión o una pantalla con fondo azul.

④ Pulse [⏻ DVD POWER].

Deje la unidad apagada hasta que descargue la lista de programas de televisión. Esto puede tardar un máximo de 24 horas.

Cuando la unidad esté conectada a un receptor de TV por cable

- El receptor de TV por cable deberá encenderse para poder descargar la lista de programas de televisión.
- Tenga en cuenta que la lista de programas de televisión tal vez no pueda descargarse correctamente si usted cambia el canal del receptor de TV por cable mientras la unidad está apagada.

Seleccione el idioma y el tipo de televisión

Consulte la ilustración que aparece en la página 12 de la sección en idioma inglés.

- ① Pulse [SETUP].
- ② Pulse [▲, ▼] para seleccionar “Display” y pulse [▶].
- ③ Pulse [▲, ▼] para seleccionar “On-screen Language” y pulse [ENTER].
- ④ Pulse [▲, ▼] para seleccionar “Español” y pulse [ENTER].
- ⑤ Pulse [◀].
- ⑥ Pulse [▲, ▼] para seleccionar “Pantalla TV” y pulse [▶].
- ⑦ Pulse [▲, ▼] para seleccionar “Tipo TV” y pulse [ENTER].
 - Aspecto 4:3/Aspecto 16:9:
 - Televisor de aspecto estándar 4:3
 - Televisor panorámico 16:9
 - 480P/480i:
 - Seleccione “480P” si el televisor es compatible con salida progresiva.
- ⑧ Pulse [▲, ▼] para seleccionar el elemento y pulse [ENTER].

Para salir de la pantalla

Pulse [SETUP].

Para volver a la pantalla anterior

Pulse [RETURN].

Grabación y reproducción

Consulte las ilustraciones de las páginas 16 y 24 en la sección en idioma inglés.

Grabación de programas de televisión

Preparación

Pulse [RETURN] para salir de la lista de programas de televisión si ésta se visualiza en el televisor.

- ① Pulse [HDD] o [DVD] para seleccionar la unidad de grabación.
- ② Si selecciona la unidad DVD
Pulse [▲ OPEN/CLOSE] en la unidad principal para abrir la bandeja e introducir el disco.
 - Pulse de nuevo el botón para cerrar la bandeja.
- ③ Pulse [^ v CH] para seleccionar el canal.
- ④ Pulse [REC MODE] para seleccionar el modo de grabación (XP, SP, LP o EP).
- ⑤ Pulse [● REC] para empezar a grabar.

Reproducción mientras usted está grabando **HDD** **RAM**

Reproducción con presecución

Puede empezar a reproducir desde el comienzo del título que está grabando.

Pulse [▶] (PLAY).

Grabación y reproducción simultáneas

Puede reproducir un título grabado previamente.

- 1 Pulse [DIRECT NAVIGATOR].
- 2 Pulse [▲, ▼, ◀, ▶] para seleccionar un título y pulse [ENTER].
 - Para salir de la pantalla Direct Navigator, pulse [DIRECT NAVIGATOR].

Time Slip

Usando el ajuste de tiempo puede especificar la escena deseada del título grabado o del título que está siendo grabado y ver ambas en dos ventanas de la pantalla.

- 1 Pulse [TIME SLIP].
- 2 Pulse [▲, ▼] introducir el tiempo y pulse [ENTER].
 - Pulse [TIME SLIP] para mostrar las imágenes de reproducción completas. Pulse de nuevo para mostrar las imágenes de reproducción y grabación.

Reproducción de discos

Preparación

Pulse [RETURN] para salir de la lista de programas de televisión si ésta se visualiza en el televisor.

- ① Pulse [HDD] o [DVD] para seleccionar la unidad de reproducción.
- ② Si selecciona la unidad DVD
Pulse [▲ OPEN/CLOSE] en la unidad principal para abrir la bandeja e introducir el disco.
- ③ Pulse [▶] (PLAY).

Para detener

Pulse [■].

Para hacer una pausa

Pulse [⏸].

Angle	30	Erase		Protection	
Antenna system	47	All titles	44	Card	44
Audio		Chapter	26, 33, 35	Cartridge	44
Attribute	30	Folder	36	Disc	44
Language	47	Play list	26, 35	Folder	36
Playback	26	Still picture	36	Still picture	36
Receiving, recording	17	Title	26, 33	Title	33
Change Thumbnail	33	Favorite	23	Quick View	25
Channel		Finalize	45, 53	Ratings level	48
Adjusting, hiding	23	Flexible Recording	18	Recording	
Audio	30	Format	45, 53	DV automatic recording	41
Auto Channel Setting	50	FR (Flexible Recording Mode)	17	Flexible Recording	18
Captions	51	FUNCTIONS window	43	Mode	17
Chapter	26, 32	JPEG	28, 53	Relief	21
Chasing playback	18	Language		Timer	19–22
Cleaning		Audio	47	Re-initialize settings	47
Disc	60	Code list	55	Relief Recording	21
Lens	60	On-screen	49	Remote control code	13
Main unit	60	Sound track	30	Repeat play	31
Clock setting	11, 50	Subtitle	30, 47	Resume play function	25
CM Skip	25	LPCM	49, 53	SD card	15
Connection		Menu		SETUP menu	47
Amplifier, system component	9	MP3	27	Shorten (titles)	33
Antenna	7, 8, 9	On-screen	30	Simultaneous rec and play	18
Cable TV box	8	SETUP	47	Sound track	30
DV input terminal	41	Mode		Status messages	31
IR Blaster	8	Recording	17	Still pictures	
L2 input terminals	41	Still Mode	48	Edit	36
Television	7	MPEG-DNR	31	Play	28
Video cassette recorder	7, 41	MP3	27	Transferring (dubbing)	42
Copy (play list)	35	Noise redction (NR)		Subtitle	30
CPRM	53	Integrated DNR	31	TIFF	28, 53
Create play lists	34	MPEG-DNR	31	Time Slip	18, 25
Dialog Enhancer	31	Line-in NR	48	Timer recording	19–22
Direct Navigator	24, 29, 32, 36	3D NR	31	Transfer	31
Divide Chapter	33	One Touch Transfer (dubbing)	38	Transfer (dubbing)	
Divide Title	33	On-screen		List	38
DPOF	36, 53	Language	49	One Touch Transfer (dubbing)	38
DV automatic recording	41	Menus	30	Still picture	42
DVD-R (Enabling DVD-R to be played on other equipment—Finalize)	45	Status messages	31	TV Guide On Screen™	19, 23
DVD-R High-Speed Recording	48	PC card	15	TV Type	12
DVD-RAM, DVD-R	14	PCM Down Conversion	49	VCR Plus+	21
Enter name		Picture	31	V.S.S.	31
Disc	44	Play list	34		
Entering text	46	Progressive	31, 53		
Folder	36	Properties			
Play list	35	Play list	35		
Title	33	Still picture	29		
		Title	33		

Manufactured under license from Dolby Laboratories.
“Dolby” and the double-D symbol are trademarks of Dolby Laboratories.

“DTS” and “DTS 2.0 + Digital Out” are trademarks of Digital Theater Systems, Inc.

U.S. patent Nos. 4,631,603, 4,577,216, 4,819,098, and 4,907,093.

MPEG Layer-3 audio decoding technology licensed from Fraunhofer IIS and Thomson multimedia.

This product incorporates copyright protection technology that is protected by U.S. patents and other intellectual property rights. Use of this copyright protection technology must be authorized by Macrovision, and is intended for home and other limited consumer uses only unless otherwise authorized by Macrovision. Reverse engineering or disassembly is prohibited.

●SD logo is a trademark.

●Portions of this product are protected under copyright law and are provided under license by ARIS/SOLANA/4C.

Panasonic Consumer Electronics Company, Division of Matsushita Electric Corporation of America
One Panasonic Way Secaucus,
New Jersey 07094
<http://www.panasonic.com>

Panasonic Sales Company, Division of Matsushita Electric of Puerto Rico, Inc. (“PSC”)
Ave. 65 de Infantería, Km. 9.5
San Gabriel Industrial Park, Carolina,
Puerto Rico 00985

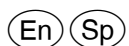

Free Manuals Download Website

<http://myh66.com>

<http://usermanuals.us>

<http://www.somanuals.com>

<http://www.4manuals.cc>

<http://www.manual-lib.com>

<http://www.404manual.com>

<http://www.luxmanual.com>

<http://aubethermostatmanual.com>

Golf course search by state

<http://golfingnear.com>

Email search by domain

<http://emailbydomain.com>

Auto manuals search

<http://auto.somanuals.com>

TV manuals search

<http://tv.somanuals.com>