

# Panasonic®

Operating Instructions

## DVD Recorder

Model No. **DMR-ES45V**  
**DMR-ES46V**

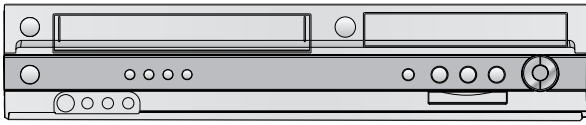

Getting started

Recording

Playing back

Editing

Transferring  
(Copying)

Convenient  
functions

Reference

Español





Rea  
listed b.

- (1) Read u.
- (2) Keep the
- (3) Heed all wa.
- (4) Follow all instr.
- (5) Do not use this ap.
- (6) Clean only with dry c
- (7) Do not block any ventila  
the manufacturer's instruc
- (8) Do not install near any heat s  
registers, stoves, or other appa  
produce heat.
- (9) Do not defeat the safety purpose of u.  
type plug. A polarized plug has two bla  
the other. A grounding-type plug has two c  
grounding prong. The wide blade or the third  
for your safety. If the provided plug does not fit i  
consult an electrician for replacement of the obso

## Unit care

The precision parts in the unit are readily affected by the environment, especially temperature, humidity, and dust. Cigarette smoke also can cause malfunction or breakdown.

To clean the unit, wipe with a soft, dry cloth.

- Never use alcohol, thinner or benzine to clean the unit.
- Before using chemically treated cloth, carefully read the instructions that came with the cloth.

Observe the following points to ensure continued listening and viewing pleasure.

Dust and dirt may adhere to the unit's lens over time, possibly making it impossible to record or play discs.

Use the **DVD lens cleaner** about once every year, depending on frequency of use and the operating environment.

Carefully read the lens cleaner's instructions before use.

Lens cleaner: RF-CL720PP

T,

**Before m.  
Failure to do  
unit.**

### ■ Cautions as to c

Condensation can cause

Condensation may form in t.

- The unit is brought from cold
- The unit is suddenly brought fro  
air-conditioned room or car, to a pl
- During the rainy season.

In any of the above-mentioned conditions,  
at least 2 hours. The unit is not equipped wi.

### ■ Other precautions for installation

- The unit should not be installed or operated near  
electromagnetic devices. Such devices can damage  
VHS recordings.
- Do not place any heavy objects atop the unit, and do not i  
a confined space. Please allow for adequate air circulation.
- The unit should not be mounted in a vertical position. It's desig  
to operate in the horizontal position.

### ■ When the unit is not to be used for a long time

To save power, unplug it from the household AC outlet. The unit consumes a small amount of power even when it is turned off.

### Standby power consumption

### ■ Quick Start (→ 63)

1 Sec. Quick Start for Recording on

- \* From the power off state, recording starts about 1 second after first pressing the [⏻, DVD/VHS POWER] and then sequentially pressing the [●, REC] (Quick Sta

## Getting started

|  |           |
|--|-----------|
| <b>IMPORTANT SAFETY INSTRUCTIONS</b> .....                                       | <b>3</b>  |
| <b>Unit care</b> .....   | <b>3</b>  |
| <b>Accessories</b> .....   | <b>5</b>  |
| <b>Disc and card information</b> .....   | <b>6</b>  |
| Discs you can use for recording and play .....                                   | 6         |
| Play-only discs .....  | 7         |
| Discs that cannot be played .....  | 7         |
| Concerning logo marks .....  | 7         |
| Cards usable on this unit .....  | 8         |
| • Suitable SD Memory Cards .....   | 8         |
| Using DVD-R, DVD-R DL, DVD-RW, +R, +R DL and<br>+RW on this unit .....           | 9         |
| <b>The remote control</b> .....  | <b>10</b> |
| <b>Disc and card handling</b> .....  | <b>10</b> |
| <b>Video cassette information</b> .....  | <b>11</b> |
| <b>Inserting/Removing the SD card</b> .....                                      | <b>11</b> |
| <b>Useful features</b> .....   | <b>11</b> |
| <b>Control reference guide</b> .....   | <b>12</b> |
| Remote control .....   | 12        |
| Main unit .....  | 13        |
| The unit's display .....   | 13        |
| <b>STEP 1 Connection</b> .....   | <b>14</b> |
| Connection with a television .....   | 14        |
| Connection with a television and<br>cable box or satellite receiver .....        | 15        |
| If the antenna connector doesn't match .....                                     | 15        |
| DVD output and DVD/VHS output .....  | 15        |
| To enjoy higher picture quality .....  | 16        |
| • Connecting to the TV S VIDEO IN terminal .....                                 | 16        |
| • Connecting to the TV COMPONENT VIDEO IN terminals .....                        | 16        |
| Connecting an amplifier or system component .....                                | 16        |
| Connecting with an HDMI<br>(High Definition Multimedia Interface) terminal ..... | 17        |
| • Connecting to a TV .....   | 17        |
| • Connecting to an amplifier .....   | 17        |
| Control with HDMI (HDMI Control) .....   | 17        |
| <b>STEP 2 Plug-in Auto Tuning</b> .....  | <b>18</b> |
| • Restart Plug-in Auto Tuning<br>(after relocation, for example) .....           | 19        |
| • Restart Set Channels Automatically .....                                       | 19        |
| • Adding and deleting channels .....   | 19        |
| • Set Clock Manually .....   | 19        |
| <b>Other settings</b> .....  | <b>20</b> |
| Channel captions .....   | 20        |
| • Preset Channel Captions .....  | 20        |
| • Manual Channel Captions .....  | 20        |
| Selecting television type .....  | 20        |
| Television operation .....   | 21        |
| When other Panasonic products respond to<br>this remote control .....            | 21        |
| Clock Settings .....   | 22        |
| • Set Clock Automatically .....  | 22        |
| • Adjust Time Zone .....   | 22        |
| Removing Interference .....  | 23        |

## Recording

|  |           |
|--|-----------|
| <b>Recording television programs</b> .....                         | <b>24</b> |
| Inserting discs .....  | 24        |
| Inserting a video cassette .....                                   | 24        |
| Recording procedures .....   | 25        |
| • Recording modes and<br>approximate recording times (DVD) .....   | 26        |
| • Recording modes (VHS) .....                                      | 26        |
| • Off Timer .....  | 27        |
| • When the format confirmation screen is displayed .....           | 27        |
| • When remove a recorded disc .....                                | 27        |
| To specify a time to stop recording<br>– One Touch Recording ..... | 27        |
| Selecting audio to record .....                                    | 27        |
| Auto Bilingual Choice Function .....                               | 27        |
| Playing DVD while recording VHS .....                              | 28        |
| Playing VHS while recording DVD .....                              | 28        |
| Watching the TV while recording .....                              | 28        |
| Playing while you are recording .....                              | 28        |

|  |           |
|--|-----------|
| • Playing from the beginning of the title you are recording<br>– Chasing playback .....    | 28        |
| • Playing a title previously recorded while recording<br>– Simultaneous rec and play ..... | 28        |
| Flexible Recording<br>(Recording that fits the remaining disc space) .....                 | 29        |
| <b>Scheduled Recording</b> .....   | <b>30</b> |
| Cautions for using scheduled recording on<br>DVD and VHS .....                             | 30        |
| Programming scheduled recordings .....   | 30        |
| • Cancel scheduled recording that has already begun .....                                  | 31        |
| • Release program from recording standby .....   | 31        |
| • Auto SP/EP mode .....  | 31        |
| • Check, change or delete programs .....   | 31        |





## Playing back

|   |           |
|---|-----------|
| <b>Playing discs</b> .....  | <b>32</b> |
| Playing discs .....   | 32        |
| • When a menu screen appears on the TV .....                                | 32        |
| Selecting recorded titles to play .....                                     | 32        |
| Quick View (Play ×1.3) .....  | 32        |
| Fast forward and rewind– SEARCH .....                                       | 32        |
| Skipping .....  | 33        |
| Slow-motion play .....  | 33        |
| Frame-by-frame viewing .....  | 33        |
| Direct play .....   | 33        |
| CM Skip .....   | 33        |
| Create chapters .....   | 33        |
| Skipping the specified time — Time Slip .....                               | 33        |
| Changing audio during play .....  | 33        |
| <b>Using menus to play MP3 and<br/>still pictures (JPEG/TIFF)</b> .....     | <b>34</b> |
| Playing discs which contain both MP3 and<br>still pictures .....            | 34        |
| Playing MP3 .....   | 34        |
| • Using the tree screen to find a group .....                               | 34        |
| To show Pictures Menu .....   | 35        |
| Playing still pictures (JPEG/TIFF) .....                                    | 35        |
| Useful functions during still picture play .....                            | 35        |
| • To select the still pictures in another folder .....                      | 35        |
| • Start Slideshow/Slideshow settings .....                                  | 36        |
| • To rotate a still picture .....   | 36        |
| • To zoom in/out .....  | 36        |
| • To delete a still picture .....   | 36        |
| • To show the picture properties .....                                      | 36        |
| <b>Playing a video cassette</b> .....                                       | <b>37</b> |
| Fast-forward/Rewind .....   | 37        |
| Cue/Review .....  | 37        |
| Jet Search .....  | 37        |
| Slow .....  | 37        |
| Jet Rewind .....  | 37        |
| S-VHS Quasi Playback (SQPB) .....   | 37        |
| Repeat Playback .....   | 37        |
| Adjusting the playback picture .....  | 38        |
| • Manual tracking .....   | 38        |
| • Vertical locking adjustment .....   | 38        |
| VHS Index Search System (VISS) .....  | 38        |
| Various on-screen display indications .....                                 | 38        |
| <b>Using on-screen menus/FUNCTIONS window and<br/>Status messages</b> ..... | <b>39</b> |
| Using on-screen menus .....   | 39        |
| • Common procedures .....   | 39        |
| - Disc menu – Setting disc content .....                                    | 39        |
| - Play menu – Change play sequence .....                                    | 39        |
| - Video menu – Change picture quality .....                                 | 40        |
| - Audio menu – Change sound effect .....                                    | 40        |
| - Other menu – Change the display position .....                            | 40        |
| FUNCTIONS window .....  | 40        |
| Status messages .....   | 40        |



- \*1 You can record onto the second layer of dual- or double-layer discs after closing the first layer (→ 62). You will no longer be able to record to the first layer after you do this (→ 9).  
When playing a title recorded on both layers, video and audio may momentarily cut out when the unit is switching layers.
  - \*2 You may not be able to use +R recorded on this unit in another Panasonic DVD recorder and vice versa. Once the disc is finalized, however, it can be played in the other unit.
  - \*3 The amount of the recordable disc space doesn't increase even if the program is deleted when you use a one time recording disc.
  - \*4 This unit can use the high-speed recording discs shown in the chart, but using them will not shorten the recording time.
  - \*5 You can play 8x recording speed discs recorded on another equipment.
  - \*6 Play on DVD-R DL compatible equipment.
  - \*7 CPRM (→ 76) compatible discs only
  - \*8 The recording space may increase slightly when other titles are deleted.
- The explanations concerning discs are indicated by **DVD**, and those concerning video are indicated by **VHS**.
  - We recommend using Panasonic discs. We recommend using DVD-RAM discs with cartridges to protect them from scratches and dirt.
  - You may not be able to record depending on the condition of the discs and you may not be able to play due to the condition of the recording.
  - You cannot record programs that allow "One time only recording" to CPRM compatible DVD-R, DVD-R DL and DVD-RW on this unit. You can record other programs as DVD-Video format.
  - For the recording time, refer to "Recording modes and approximate recording times (DVD)" on page 26.

## Play-only discs

| Disc type                            | DVD-Video   | DVD-Audio   | DVD-RW<br>(DVD Video Recording format)  | Audio CD  |  | Video CD  |
|--------------------------------------|---|---|---|---|--|---|
| Logo                                 |  |  |    |  | —  |  |
| Indicated in these instructions with | <b>DVD-V</b>  | <b>DVD-A</b>  | <b>-RW(VR)</b>  | <b>CD</b>   |  | <b>VCD</b>  |
| Instructions                         | High quality movie and music discs  | High fidelity music discs<br>● Played on this unit in 2 channels                  | DVD-RW* recorded on another DVD recorder<br>● You can play programs that allow "One time only recording" if they have been recorded to a CPRM compatible disc.<br>● By formatting (→ 61) the disc, you can record to it in DVD-Video format.<br>● It may be necessary to finalize the disc on the equipment used for recording. | Recorded audio and music (including CD-R/RW*)                                       | CD-R* and CD-RW* with music recorded in MP3 (→ 34) Still pictures (JPEG and TIFF) recorded on CD-R/RW* | Recorded music and video (including CD-R/RW*)                                       |

\* Play may be impossible on some DVD-RW (DVD Video Recording format), CD-R or CD-RW discs due to the condition of the recording.

- You can play still pictures (JPEG/TIFF), CD-DA, Video CD and MP3 format data recorded on CD-R/RW. Close the session or finalize the disc after recording.
- The producer of the disc can control how discs are played. So you may not always be able to control play as described in these operating instructions. Read the disc's instructions carefully.

### Note about using a DualDisc

The digital audio content side of a DualDisc does not meet the technical specifications of the Compact Disc Digital Audio (CD-DA) format so play may not be possible.



### Regarding DVD-Audio

Some multi-channel DVD-Audio will prevent down-mixing (→ 76) of all or part of their contents if this is the manufacturer's intention. Tracks that are prevented from being down-mixed will not play properly on this unit (e.g. audio is played from the front two channels only). Refer to the disc's jacket for more information.

## Discs that cannot be played

- 2.6/5.2 GB DVD-RAM, 12 cm (5")
- 3.95/4.7 GB DVD-R for Authoring
- DVD-R recorded in DVD Video Recording format
- DVD-R (DVD-Video format), DVD-R DL, DVD-RW (DVD-Video format), +R, +R DL recorded on another unit and not finalized (→ 61, "Enabling discs to be played on other equipment –Finalize")
- PAL discs (you can still play the audio on DVD-Audio)
- DVD-Video with a region number other than "1" or "ALL"
- Blu-ray
- DVD-ROM, +R 8cm (3"), CD-ROM, CDV, CD-G, Photo CD, CVD, SVCD, SACD, MV-Disc, PD, DivX Video Disc, etc.

## Concerning logo marks

|   |  |
|---|--|
|  | <b>Dolby Digital (→ 64)</b><br>This is a method of coding digital signals developed by Dolby Laboratories. Not only stereo (2 channel) audio, these signals can also be multi-channel audio. A large amount of audio information can be recorded on one disc by this method. |
|  | <b>DTS Digital Surround (→ 64)</b><br>This surround system is used in many movie theaters around the world. The separation between channels is good and the compression ratio is low, so realistic sound effects are possible.   |

**The manufacturer accepts no responsibility and offers no compensation for loss of recorded or edited material due to a problem with the unit or recordable media, and accepts no responsibility and offers no compensation for any subsequent damage caused by such loss.**

### Examples of causes of such losses are

- A disc recorded and edited with this unit is played in a DVD Recorder or computer disc drive manufactured by another company.
- A disc used as described above and then played again in this unit.
- A disc recorded and edited with a DVD Recorder or computer disc drive manufactured by another company is played in this unit.

**Cards usable on this unit**

|                                      |  |
|--------------------------------------|--|
| Type                                 | SD Memory Card, miniSD™ Card*, MultiMediaCard  |
| Indicated in these instructions by   | <b>SD</b>  |
| Data that can be recorded and played | Still pictures   |
| Instructions                         | <p>You can insert directly into the SD card slot.</p> <p>* A miniSD™ card adaptor included with the miniSD™ card is necessary.</p> <ul style="list-style-type: none"> <li>• You can play and copy still pictures taken on a digital camera, etc. (→ 35, 55)</li> <li>• You can set the DPOF (Digital Print Order Format) for automatic printing on your home printer or at a photo developing store. (→ 48, 76)</li> </ul> |

**Structure of folders displayed by this unit**

The following  can be displayed on this unit.

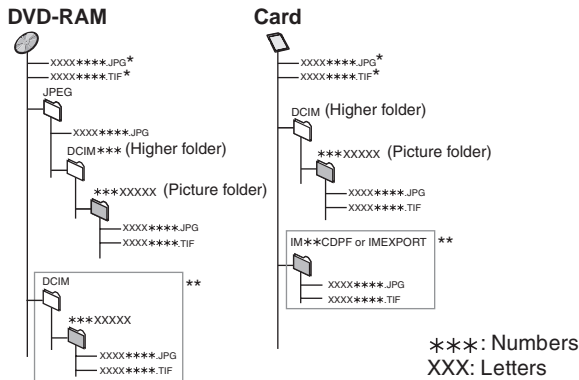

\* This can be also displayed

\*\* Folders can be created on other equipment. However, these folders cannot be selected as a copying destination.

• The folder cannot be displayed if the numbers are all "0" (e.g., DCIM000, etc.).

• If a folder name or file name has been input using other equipment, the name may not be displayed properly or you may not be able to play or edit the data.

**■ Suitable SD Memory Cards**

• You can use SD Memory Cards with the following capacities (from 8 MB to 2 GB).

**8 MB, 16 MB, 32 MB, 64 MB, 128 MB, 256 MB, 512 MB, 1 GB, 2 GB (Maximum)**

• Useable memory is slightly less than the card capacity.  
 • Please confirm the latest information on the following website.  
<http://panasonic.co.jp/pavc/global/cs> (This site is in English only.)

• If the SD Memory Card is formatted on other equipment, the time spent for recording may become longer. Also if the SD Memory Card is formatted on a PC, you may not be able to use it on this unit.

In these cases, format the card on this unit. (→ 61, 76)

• This unit supports SD Memory Cards formatted in FAT 12 system and FAT 16 system based on SD Memory Card Specifications.





# The remote control

## About batteries

- Insert so the poles (+ and -) match those in the remote control.
- Do not use rechargeable type batteries.

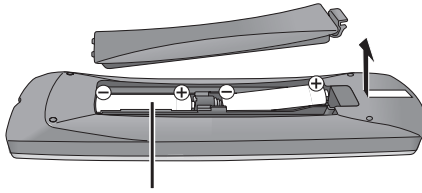

R6/LR6, AA

### Do not:

- mix old and new batteries.
- use different types at the same time.
- heat or expose to flame.
- take apart or short circuit.
- attempt to recharge alkaline or manganese batteries.
- use batteries if the covering has been peeled off.

Mishandling of batteries can cause electrolyte leakage which can damage items the fluid contacts and may cause a fire.

Remove if the remote control is not going to be used for a long period of time. Store in a cool, dark place.

### Note

- If you cannot operate the unit or TV using the remote control after changing the batteries, please re-enter the codes (→ 21).

## How to use the remote control

Aim at the sensor, avoiding obstacles, at a maximum range of 7 m (23 feet) directly in front of the unit.

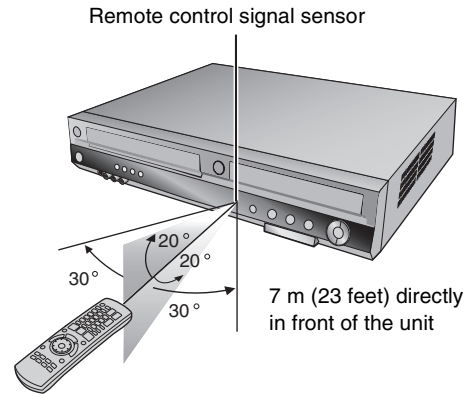

### Notes

- Keep the transmission window and the unit's sensor free from dust.
- Operation can be affected by strong light sources, such as direct sunlight, inverter fluorescent lamps, and the glass doors on cabinets.

# Disc and card handling

## How to hold a disc or card

Do not touch the recorded surface or the terminal surface.

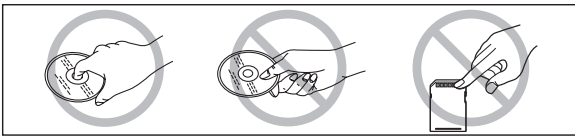

## Concerning non-cartridge discs

Be careful about scratches and dirt.

## If there is dirt or condensation on the disc

Wipe with a damp cloth and then wipe dry.

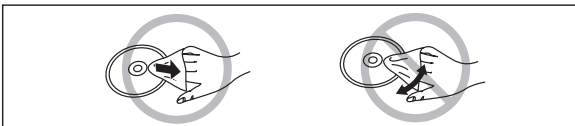

## Handling precautions

- Do not attach labels or stickers to discs. (This may cause disc warping and unbalanced rotation, rendering it unusable.)
- Write on the label side of the disc only with a soft, oil-based felt pen. Do not use ballpoint pens or other hard writing implements.
- Do not use record cleaning sprays, benzene, thinner, static electricity prevention liquids or any other solvent.
- Do not use scratch-proof protectors or covers.
- Do not expose the terminals of the card to water, garbage or other strange things.
- Do not drop, stack, or cause impact to discs. Do not place objects on them.
- Do not use the following discs:
  - Discs with exposed adhesive from removed stickers or labels (rental discs etc.).
  - Discs that are badly warped or cracked.
  - Irregularly shaped discs, such as heart shapes.

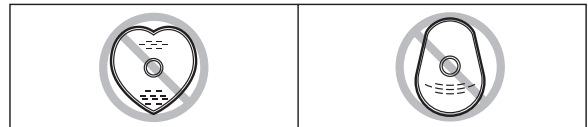

- Do not place in the following areas:
  - In direct sunlight.
  - In very dusty or humid areas.
  - Near a heater.
  - Locations susceptible to significant differences in temperature changes (condensation can occur).
  - Where static electricity or electromagnetic waves occur.
- To protect discs from scratches and dirt, return them to their cases or cartridges when you are not using them.

## Video cassette information

### ■ Video cassettes

- Break off the video cassette's tab to prevent accidental erasure. Cover the hole with a double adhesive tape when you want to use the video cassette for recording again.
- You can use video cassettes with the VHS and S-VHS marks, but the unit is unable to make full use of the characteristics of S-VHS video cassettes.

### ■ Video cassette care

- Poor quality or damaged video cassettes can cause the heads to become dirty and malfunction. Discard them when they become dirty or damaged.
- Never use video cassettes on which juice has been spilled or those that are extremely damaged. They may become dirty, but will also make the unit malfunction.

### ■ Maintenance



#### Cleaning the video heads

Dirt on the video heads can cause poor recording and play.

If the picture does not improve, use an optional head-cleaning cassette (part number NV-TCL30PT). If the problem persists, seek advice from a qualified service person.

## Inserting/Removing the SD card

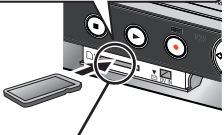
When the card indicator ("SD") on the unit's display is flashing, the card is being read from or written to. Such action may result in malfunction or loss of the card's contents.

| Opening the cover   | Inserting the card   | Removing the card   |
|---|--|---|
| <p>Press down.</p>                  | <p>Press on the center of the card until it clicks into place.</p>  <p>If you are using a miniSD™ card, insert it into the miniSD™ card adaptor that comes with the card. Insert and remove this adaptor from the unit.</p>  | <p>1</p> <p>2</p>  |
| <p>Insert the card label up with the cut-off corner on the right.<br/>(Do not forget to close the cover. → right)</p> |  |   |

#### Protect function

When the unit is stopped, the "SD Card Operations" screen is displayed. If you remove an SD card, the DVD drive is automatically closed.

Memory cards such as the SD Memory Card should be handled carefully.

with the unit.

and sounds in the unit.

The following

## Remote control

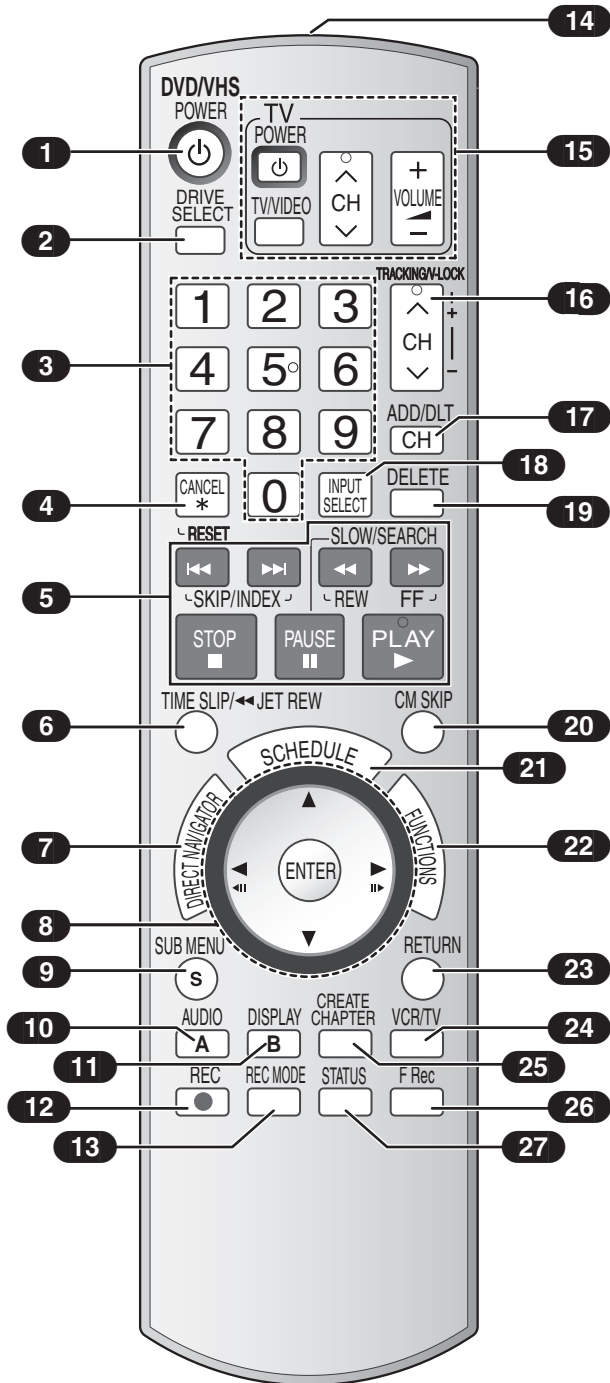

### ■ [DRIVE SELECT] button

- 1 Turn the unit on . . . . . → 18
- 2 Select drive (DVD, VHS or SD) . . . . . → above
- 3 Select channels and title numbers etc./Enter numbers
- 4 Cancel/Reset the tape counter
- 5 Basic operations for recording and play
- 6 Skip the specified time/ . . . . . → 33  
Jet rewind button (JET REW) . . . . . → 37
- 7 Direct Navigator . . . . . → 32, 34
- 8 Selection/Enter, Frame-by-frame . . . . . → 18, 33
- 9 Show sub menu. . . . . → 36, 41, 45
- 10 Select audio. . . . . → 27, 33  
View select (A) . . . . . → 53
- 11 Show on-screen menu . . . . . → 39  
View select (B) . . . . . → 53
- 12 Start recording . . . . . → 25
- 13 Change recording mode. . . . . → 25, 30
- 14 Transmission window
- 15 TV operations . . . . . → 21, 28
- 16 Channel select/  
TRACKING/V-LOCK. . . . . → 38
- 17 Add/delete channel. . . . . → 19
- 18 Input select (IN1, IN2, DV) . . . . . → 57
- 19 Delete items. . . . . → 59
- 20 Skip a minute forward. . . . . → 33
- 21 Show scheduled recording list . . . . . → 30
- 22 Show FUNCTIONS window . . . . . → 40
- 23 Return to previous screen
- 24 Select VCR/TV . . . . . → 23
- 25 Create chapters. . . . . → 33
- 26 Start Flexible Recording. . . . . → 29
- 27 Show status messages . . . . . → 38, 40

### Notes

- Buttons such as the [●, REC] button do not protrude as much as other buttons to stop them from being pressed accidentally.
- The word "button" is not used in these operating instructions so "Press the [ENTER] button." is shown as "Press [ENTER]."
- You can use this remote control to operate your TV if you set the TV manufacturer code (→ 21).

## Main unit

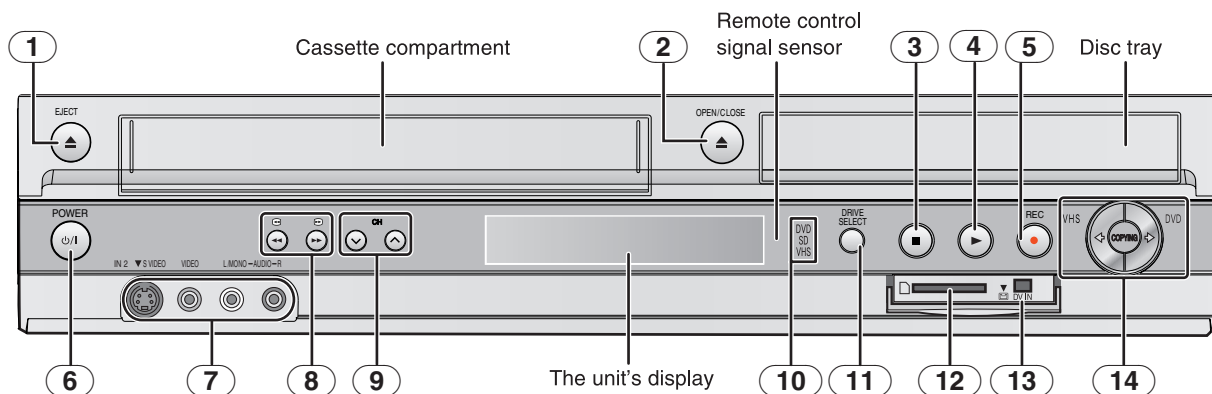

- 1** Cassette eject button (▲, EJECT) ..... → 24  
**2** Disc tray open/close button (▲, OPEN/CLOSE) ..... → 24  
**3** Stop button (■) ..... → 32, 37  
**4** Play/X1.3 button (▶) ..... → 32, 37  
**5** Recording button (●, REC) ..... → 25, 57  
**6** DVD/VHS POWER on/off button (⏻, POWER) ..... → 18  
 •To switch the unit from on to standby mode or vice versa.  
 In the standby mode, the unit is still consuming a small amount of power.  
**7** IN2 input terminals (IN2) ..... → 57  
**8** DVD-SEARCH, VHS-REW/FF buttons (◀◀/▶▶) ..... → 38  
**9** Channel up/down buttons (CH, v, ^) ..... → 38  
**10** DVD/VHS/SD drive indicator  
 •Lights when the DVD, VHS or SD drive is selected.  
**11** DRIVE SELECT button  
 •Drive changes each time you press [DRIVE SELECT].  
**12** SD card slot ..... → 11  
**13** Connector for a digital video (DV) camcorder ..... → 57  
**14** One Touch Transfer (copying) operation button  
 •From VHS to DVD ..... → 50  
 •From DVD to VHS ..... → 52

## The unit's display

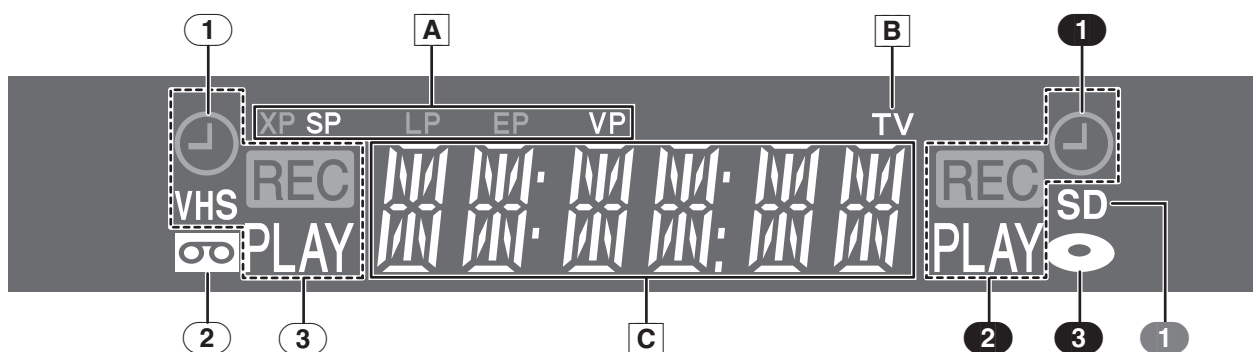

## Common to DVD/VHS/SD

## A Recording mode indicator

## DVD:

XP, SP, LP, EP: (→ 26)

XP SP LP EP (all on): FR mode (→ 29)

## VHS:

SP, LP\*, EP, VP: (→ 26)

\* Playback only

## B TV indicator

•The indicator lights during the TV mode and it goes out during the VCR mode. You can switch the mode by using [VCR/TV]. (→ 23)

## C Main display

- Current time
- Disc recording and play counter
- VHS recording and play counter
- Transfer (Copying) messages
- Miscellaneous messages, etc.

## VHS

## 1 Scheduled recording indicator (⌚) (→ 30)

## On:

When a scheduled recording program is registered and recordable tape is inserted.

## Flashes:

The scheduled recording indicator flashes when the unit cannot go to scheduled recording standby (e.g. there is no tape, etc).

## 2 Tape indicator

## 3 Tape operation status

## DVD

## 1 Scheduled recording indicator (⌚) (→ 30)

## On:

When a scheduled recording program is registered and a recordable disc is inserted.

## Flashes:

The scheduled recording indicator flashes when the unit cannot go to scheduled recording standby (e.g. there is no disc, etc).

## 2 Disc operation status

## 3 Disc indicator

## SD

## 1 SD Card indicator

# STEP 1 Connection

This section includes diagrams of two common methods of connection (A-B, pages 14 to 15). Please connect using the one that best suits you.

- Visit Panasonic's homepage for more information about connection methods. (This is in English only.)  
[http://www.panasonic.com/consumer\\_electronics/dvd\\_recorder/dvd\\_connection.asp](http://www.panasonic.com/consumer_electronics/dvd_recorder/dvd_connection.asp)
- Before doing any connection, turn off all the equipments and read the appropriate operating instructions.
- Peripheral equipments and optional cables are sold separately unless otherwise indicated.
- You need to subscribe to a cable TV service to enjoy viewing their programme.
- Consult your service provider regarding appropriate cable box.

## ■ The unit's RF OUT terminal

The picture and sound signal from this unit go through the RF OUT terminal to the television.  
 Refer to page 15 if the antenna connector doesn't match.

## ■ When the unit is not to be used for a long time

To save power, unplug it from the household AC outlet. This unit consumes a small amount of power, even when it is turned off (approx. 8 W).

## ■ Do not connect the unit through a video cassette recorder

Video signals sent through video cassette recorders will be affected by copyright protection systems and the picture will not be shown correctly on the TV.

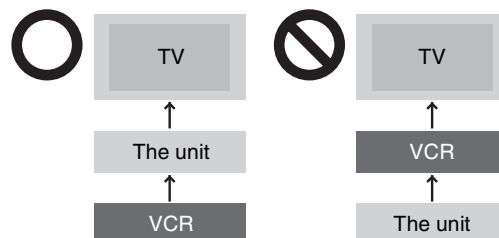

## A Connection with a television

### ■ Connection (with Audio/Video cable)

Connect in numerical order ① to ④.

- After this connection, set the RF output channel "OFF" (→ 18), and then press TV/VIDEO button of TV remote controller to select the AV input mode to the connected TV terminal. You can watch a video from this unit on your TV.

### ■ Connection (without Audio/Video cable)

You do not need to connect "③".

The unit supplies a signal to the TV via the 75 Ω coaxial cable on channel 3 or 4. It is possible to view the video picture on your TV in the same way that you watch TV broadcasts.

- After this connection, set the RF output channel "CH3" or "CH4" (→ 18).

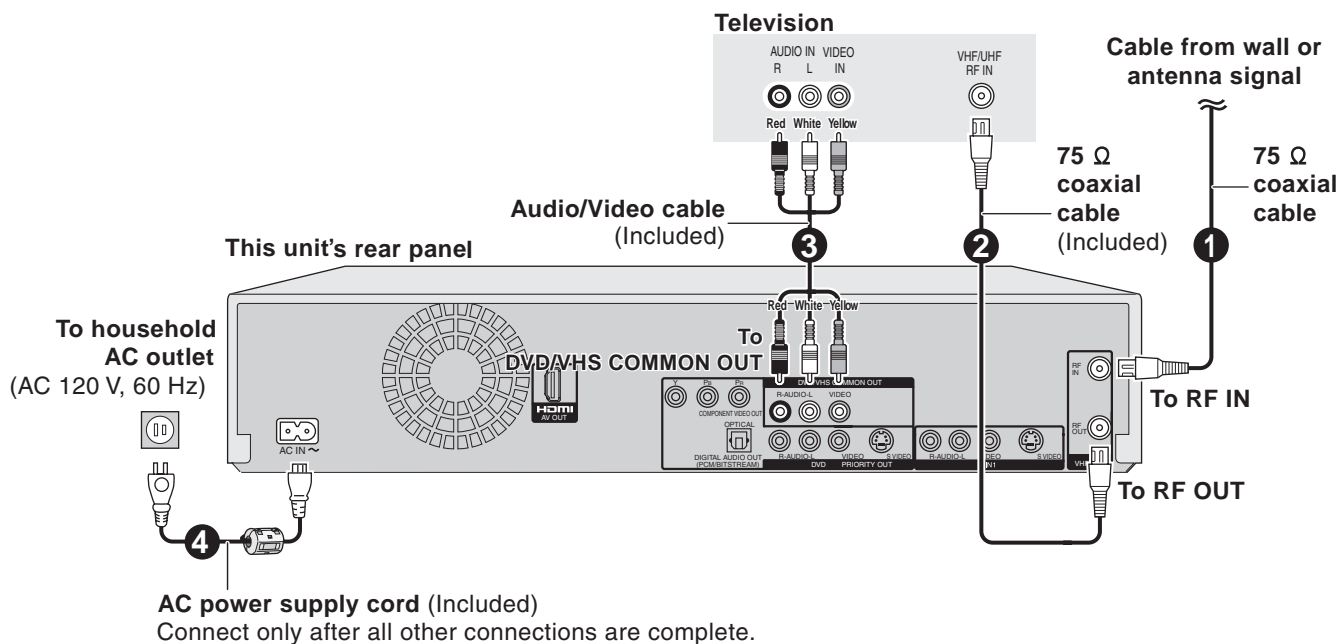

**B Connection with a television and cable box or satellite receiver**

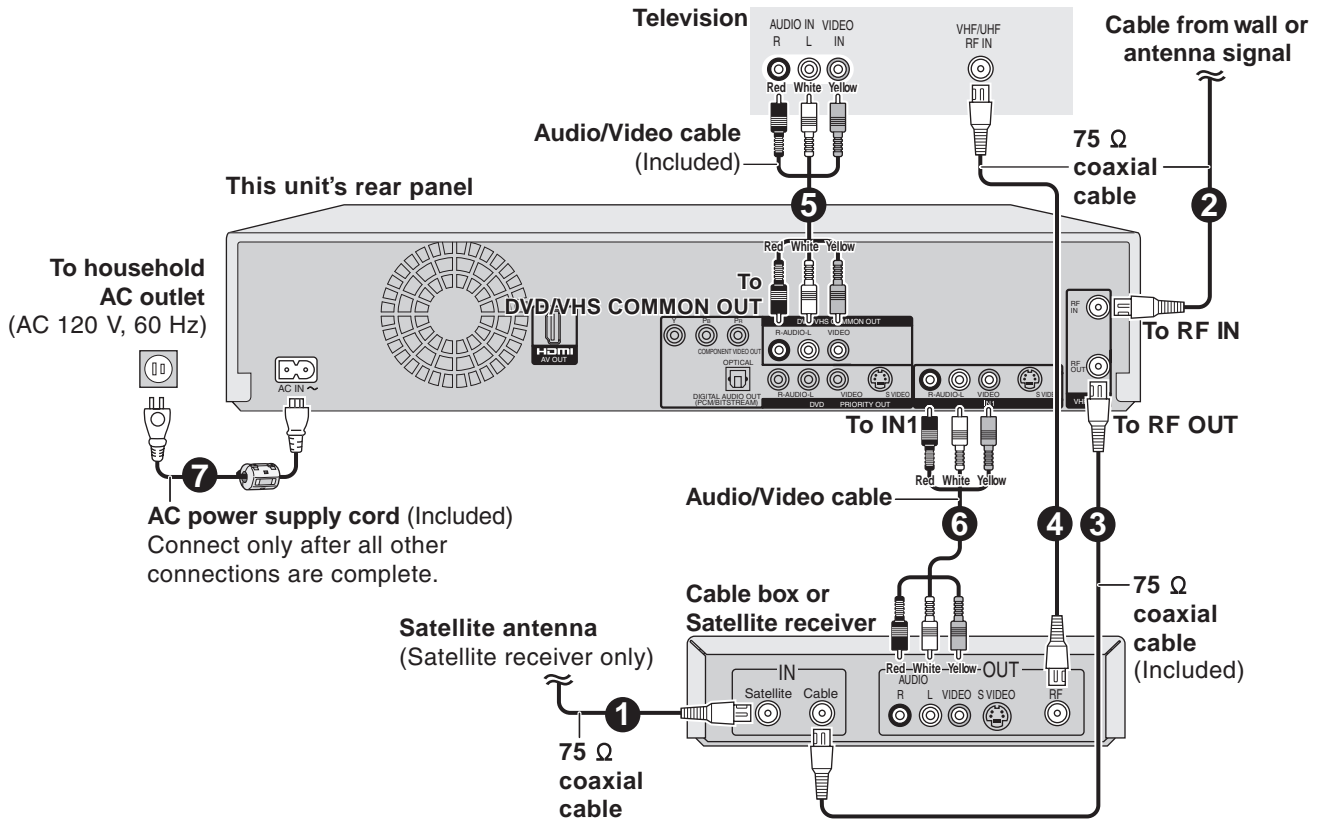

**If the antenna connector doesn't match**

Use one of the following connections to suit the antenna lead to the unit's RF IN terminal, and the 75 Ω coaxial cable to the antenna terminals on the equipment (television etc.). Refer to other equipment's operating instructions.

| Other antenna connections to the unit   | Other antenna connections to the television   |
|---|---|
| <p>■ <b>A single twin lead</b> from the antenna</p> <p>(Flat) Twin lead 300 Ω cable</p> <p>300-75 Ω transformer</p> <p>To this unit's RF IN terminal</p>  | <p>■ <b>A twin lead terminal</b></p> <p>75-300 Ω transformer</p> <p>75 Ω coaxial cable</p> <p>VHF or UHF</p> <p>Television</p>                        |
| <p>■ <b>A twin lead and a coaxial cable</b> from the antenna</p> <p>(Flat) Twin lead 300 Ω cable</p> <p>(Round) 75 Ω coaxial cable</p> <p>VHF/UHF band mixer</p> <p>To this unit's RF IN terminal</p> | <p>■ <b>A twin lead and coaxial plug terminal</b></p> <p>VHF/UHF band separator</p> <p>75 Ω coaxial cable</p> <p>VHF</p> <p>UHF</p> <p>Television</p> |
| <p>■ <b>Two twin leads</b> from the antenna</p> <p>(Flat) Twin lead 300 Ω cable</p> <p>300-75 Ω transformer</p> <p>VHF/UHF band mixer</p> <p>To this unit's RF IN terminal</p>                        | <p>■ <b>Two twin lead terminals</b></p> <p>VHF/UHF band separator</p> <p>75 Ω coaxial cable</p> <p>VHF</p> <p>UHF</p> <p>Television</p>               |

**DVD output and DVD/VHS output**

The unit has DVD/VHS COMMON output terminals and DVD PRIORITY output terminals.

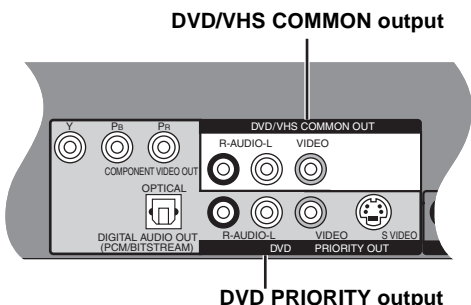

**DVD/VHS COMMON OUT**

- For DVD/VHS COMMON output terminals, both DVD and VHS signals can be output.

**DVD PRIORITY OUT**

- You can also playback a tape with the DVD PRIORITY output terminal except while recording, or making a scheduled recording, on the DVD.

To enjoy higher picture quality

■ Connecting to the TV S VIDEO IN terminal

S VIDEO OUT terminal

The S VIDEO OUT terminal achieves a more vivid picture than the VIDEO OUT terminal. (Actual results depend on the television.) After completing "Connection with a television" (→ 14) or "Connection with a television and cable box or satellite receiver" (→ 15), connect S VIDEO cable as illustration below. Usually you can watch a picture from INPUT2 terminal. When you want to playback VHS while recording on DVD, change to INPUT1 terminal.

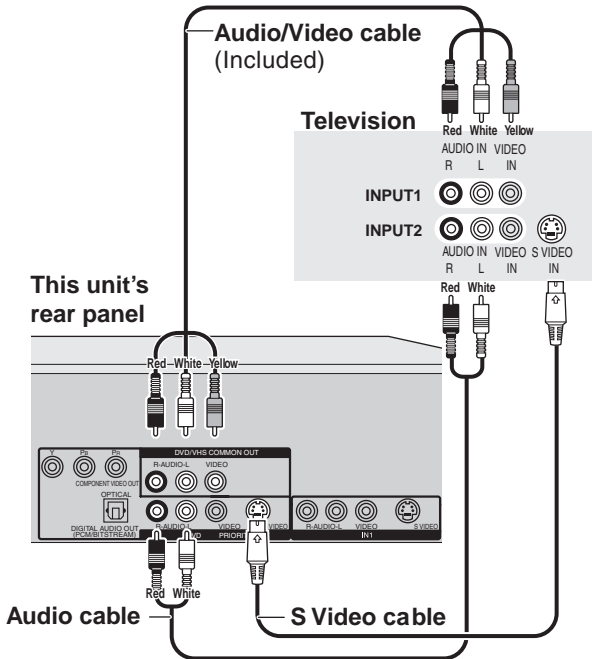

■ Connecting to the TV COMPONENT VIDEO IN terminals

COMPONENT VIDEO OUT terminal

These terminals can be used for either interlace or progressive output (→ 76) and provide a purer picture than the S VIDEO OUT terminal.

After completing "Connection with a television" (→ 14) or "Connection with a television and cable box or satellite receiver" (→ 15), connect COMPONENT VIDEO cable as illustration below. Usually you can watch a picture from COMPONENT VIDEO INPUT terminal. When you want to playback VHS while recording on DVD, change to INPUT1 terminal.

- Connect to terminals of the same color.

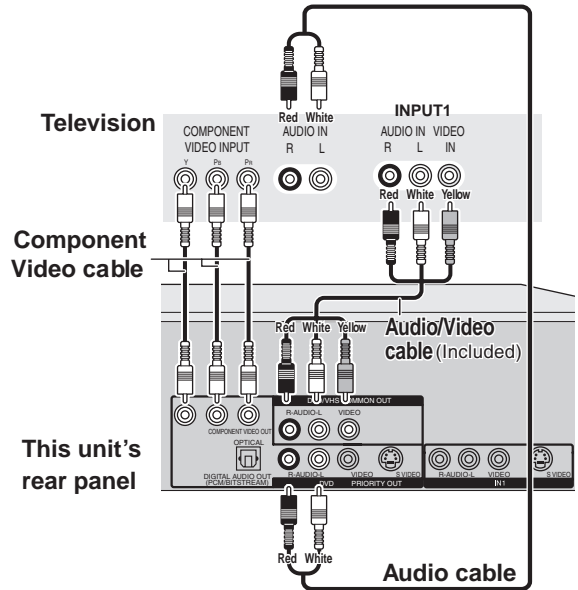

Connecting an amplifier or system component

■ Connecting an amplifier with a digital input terminal

- To enjoy multi-channel surround on DVD-Video, connect an amplifier with a built-in decoder displaying these logo marks using an optical digital audio cable and change the settings in "Digital Audio Output" (→ 64).
- Before purchasing an optical digital audio cable (not included), check the terminal shape of the connected equipment.
- You cannot use DTS Digital Surround decoders not suited to DVD.
- Even if using this connection, output will be only 2 channels when playing DVD-Audio.

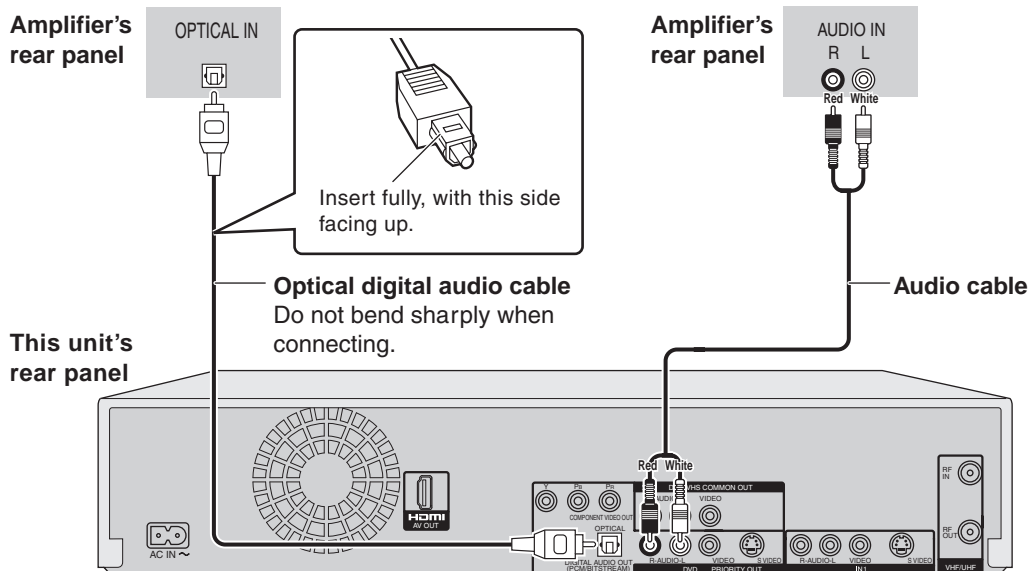



## ...tion Multimedia Interface) terminal

...HDMI compatible unit, an uncompressed digital audio and video  
...when connecting to an HDMI-compatible HDTV (High

]

# STEP 2 Plug-in Auto Tuning

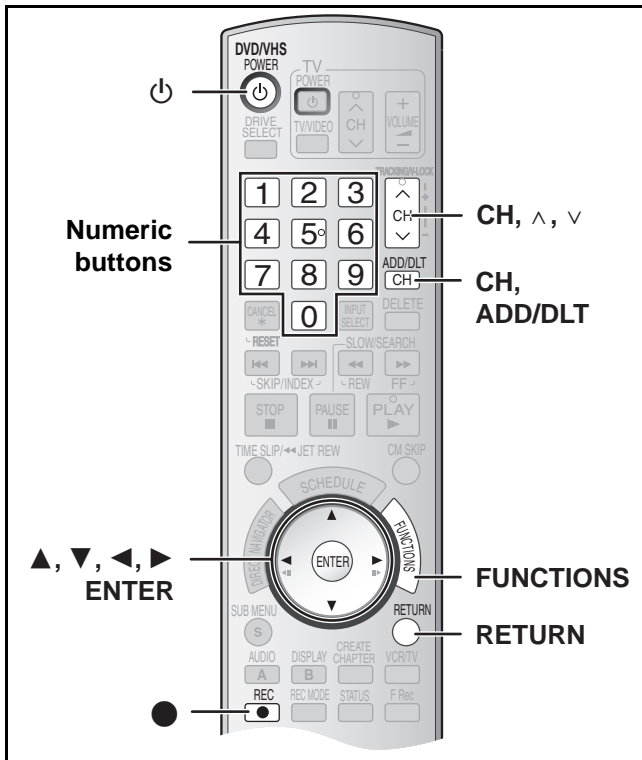

After plugging the unit into your household AC outlet and pressing [⏻, DVD/VHS POWER] to turn the unit on for the first time, the unit assists you to set the on-screen language, and automatically tunes in all the channels it can receive and sets the clock.

The unit automatically determines the type of transmission (airwaves or cable) and puts them into channels as follows.

|                         | Band                 | Channel                |
|-------------------------|----------------------|------------------------|
| Antenna Mode (Airwaves) | VHF                  | 2 to 13                |
|                         | UHF                  | 14 to 69               |
| CableTV Mode (Cable)    | VHF                  | 2 to 13                |
|                         | CATV LOW BAND        | 95 to 99               |
|                         | CATV MID/SUPER BAND  | 14 to 36               |
|                         | CATV HYPER BAND      | 37 to 65               |
|                         | ULTRA BAND           | 66 to 94<br>100 to 125 |
|                         | SPECIAL CATV CHANNEL | 1                      |

### Regarding DST (Daylight Saving Time) (→ 19)

Legal revision is expected to change the DST period in 2007. When you use the unit with DST on, the change may cause the unit's clock to go behind the actual time. Check the DST setting in Set Clock manually in the Setup menu, set DST off and reset the clock precisely if you are using this function.

### Preparation

- Turn on the TV and select the appropriate video input to suit the connections to the unit. (Example: AV input, CH3 or CH4)
- If you connect the unit through a cable box or satellite receiver (→ 15), tune to your local PBS for Auto Clock Setting to work. If there is no local PBS, set the clock manually (→ 19, "Set Clock Manually").

### 1 Press [⏻, DVD/VHS POWER].

### 2 Press [CH, ^, v] to select an RF output channel number.

**Connection (without Audio/Video cable):**

Select "CH3" or "CH4" which displays the screen on the right.

**Connection (with Audio/Video cable):**  
Select "OFF".

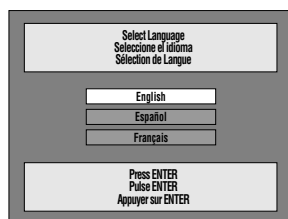

The unit's display



### The unit's display

Each time you press the button:

CH 3 (Default setting) ↔ CH 4 ↔ OFF

### 3 Use [▲, ▼] to select the language and press [ENTER].

### 4 Press [▲, ▼] to select "4:3 TV" or "16:9 Widescreen TV" and press [ENTER].

### 5 Press [▲, ▼] to select "On" or "Off" and press [ENTER].

If you activate "Quick Start" function, select "On".

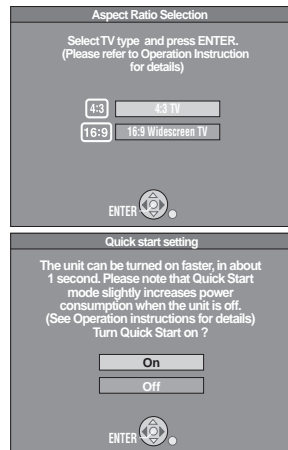

### About "Quick Start" function

If you set Quick Start to on, you can start recording to DVD-RAM about 1 second after you press [⏻, DVD/VHS POWER] to turn the unit on and then sequentially press [●, REC]. The following happens when you have selected "On".

- Power consumption in standby mode increases because power is supplied to the unit.

### 6 Press [▲, ▼] to select "Internal TV Tuner" or "Input" and press [ENTER].

When you do not set channels on this unit, select "Input". The unit then displays "Set Clock Manually" screen.

Set the clock manually. (→ 19)

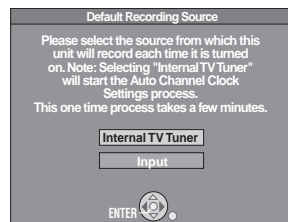

### 7 Press [ENTER] to start Plug-in Auto Tuning.

- The unit then proceeds with Auto Clock Setting. The time is displayed when Auto Clock Setting is finished.

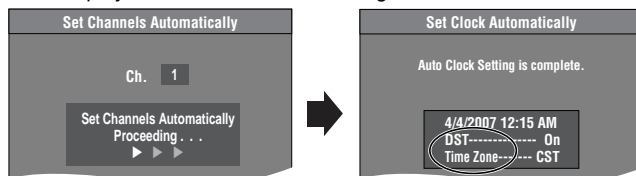

- DST, Daylight Saving Time, shows the summertime setting.
- Time Zone shows the time difference from Greenwich Mean Time (GMT).

EST (Eastern Standard Time) = GMT - 5  
 CST (Central Standard Time) = GMT - 6  
 MST (Mountain Standard Time) = GMT - 7  
 PST (Pacific Standard Time) = GMT - 8  
 AST (Alaska Standard Time) = GMT - 9  
 HST (Hawaii Standard Time) = GMT - 10  
 For other areas: xx hr

### When one of the following screens appears

#### "No channels were found."

After turning off the unit, confirm following and perform setup again.

- Confirm the antenna cable is firmly connected to RF IN terminal.

- If you do not set channels on this unit, select "Input" in step 6.

#### "Auto Clock Setting is incomplete."

Press [ENTER] and set clock manually. (→ 19)

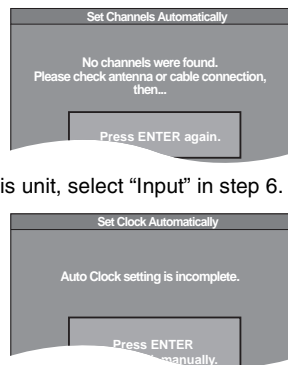

### 8 Press [ENTER].

### ■ If the clock is an hour slower or faster than the actual time

Select “-1” or “+1” in “Adjust Time Zone” in the Setup menu (→ 63).

### ■ Restart Plug-in Auto Tuning (after relocation, for example)

Signal source, RF output channel, channel caption revert to the default values when you perform the procedure below.

Scheduled recording settings are also cleared.

When the unit is on and stopped

- 1 Press and hold [CH, ^] and [CH, v] on the main unit for about 5 seconds.

The unit turns off.

- 2 Press [⏻, DVD/VHS POWER] to turn the unit on. Plug-in Auto Tuning starts.

### ■ Restart Set Channels Automatically

- 1 While stopped Press [FUNCTIONS].

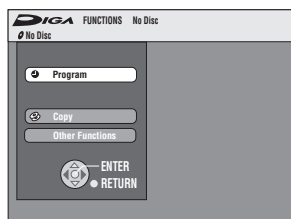

- 2 Select “Other Functions” with [▲, ▼] and press [ENTER].

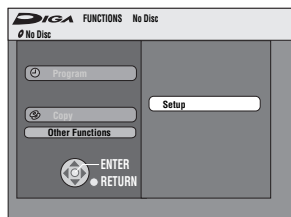

- 3 Select “Setup” with [▲, ▼] and press [ENTER].

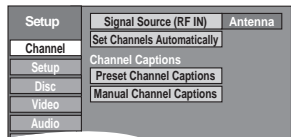

- 4 Select “Channel” with [▲, ▼] and press [◀, ▶].

- 5 Select “Signal Source (RF IN)” with [▲, ▼] and press [ENTER].

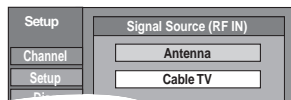

- 6 Select “Antenna” or “Cable TV” with [▲, ▼] and press [ENTER].

- 7 Select “Set Channels Automatically” with [▲, ▼] and press [ENTER].

- 8 Press [ENTER].

• Auto Channel Setting starts. This takes a few minutes.

- 9 Press [ENTER].

### ■ To cancel in the middle

Press [RETURN].

### ■ To exit the screen

Press [RETURN].

### ■ Adding and deleting channels

Add or delete channels if necessary channels are not set or unnecessary channels are set.

- 1 Press the numeric buttons to select a channel.

**Antenna Mode** (Airwaves)

e.g., “5”: [0]→[5]  
“15”: [1]→[5]

**CableTV Mode** (Cable)

e.g., “5”: [0]→[0]→[5]  
“15”: [0]→[1]→[5]  
“115”: [1]→[1]→[5]

The unit's display



• You can also use [CH, v, ^] to select a channel.

- 2 Press [CH, ADD/DLT].

e.g., The channel is deleted.

Channel 15 Deleted

### ■ Set Clock Manually

“Clock Settings” made here are applied to VHS as well.

- 1 While stopped Press [FUNCTIONS].
- 2 Select “Other Functions” with [▲, ▼] and press [ENTER].
- 3 Select “Setup” with [▲, ▼] and press [ENTER].

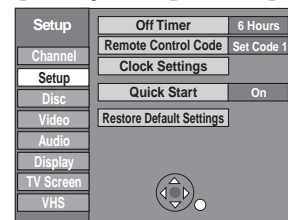

- 4 Select “Setup” with [▲, ▼] and press [◀, ▶].
- 5 Select “Clock Settings” with [▲, ▼] and press [ENTER].
- 6 Select “Set Clock Manually” with [▲, ▼] and press [ENTER].

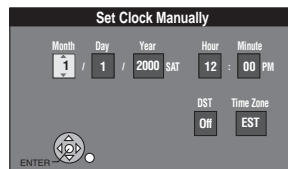

- 7 Use [◀, ▶] to select the item you want to change, and press [▲, ▼] to change the setting.

• DST (Daylight Saving Time): On or Off

If you select “On”, the clock is advanced one hour starting at 2 a.m. on the first Sunday in April and ending at 2 a.m. on the last Sunday in October.

• Time Zone (→ 22)

- 8 Press [ENTER].

• The clock starts.

• When you change the time zone, the recording times for titles recorded before the time zone adjustment also change to correspond to the new time zone.

### ■ To return to the previous screen

Press [RETURN].

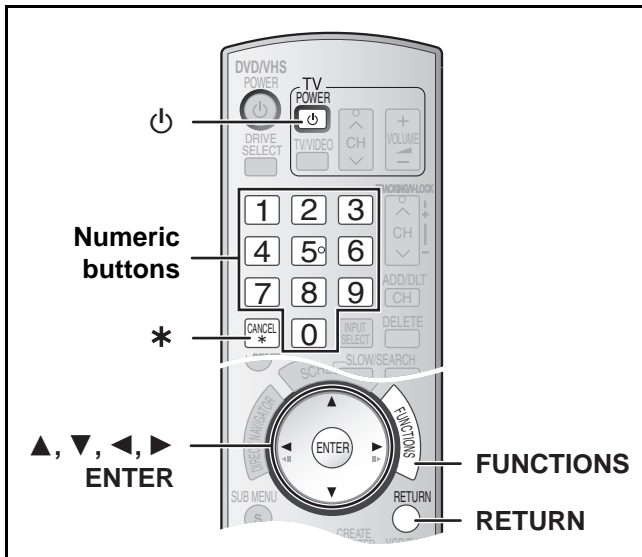

## Channel captions

You can use the preset captions, or manually enter new ones yourself. The captions you enter are used as channel names and displayed on the Direct Navigator screen.

**1** While stopped Press [FUNCTIONS].

**2** Select "Other Functions" with [▲, ▼] and press [ENTER].

**3** Select "Setup" with [▲, ▼] and press [ENTER].

**4** Select "Channel" with [▲, ▼] and press [◀, ▶].  
 • Go to the item you want to set next.

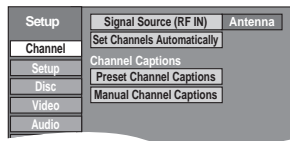
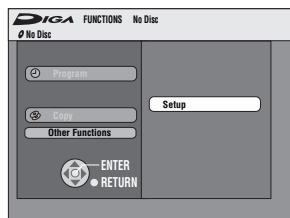

### ■ Preset Channel Captions

• Follow steps 1 to 4 of "Channel captions".

**5** Select "Preset Channel Captions" with [▲, ▼] and press [ENTER].

**6** Use [▲, ▼] to select the caption and press [▶].

You can choose from the following captions.

ABC, PBS, CBS, CNN, FOX, ESPN, NBC, HBO, A&E, AMC, FAM, MAX, MTV, SHOW, TBS, USA, TNT, CBC, UPN, CTV, WB, TSN, DSC, GLOB

• When selecting the caption, press and hold [▲, ▼] to scroll up and down the screen quickly.

**7** Use [▲, ▼] to select the channel corresponding to the caption and press [◀].

• Channels are displayed only when they contain a station and if captions have not been added manually.

• To delete the channel number, press [\*, CANCEL].

• Repeat steps 6 and 7 as necessary.

**8** Press [ENTER].

■ To return to the previous screen

Press [RETURN].

■ To exit the screen

Press [RETURN].

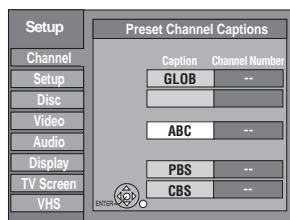

### ■ Manual Channel Captions

• Follow steps 1 to 4 of "Channel captions".

**5** Select "Manual Channel Captions" with [▲, ▼] and press [ENTER].

**6** Use [▲, ▼] to select the channel and press [▶].  
 • Channels are only displayed if they contain a station and if preset captions have not been added.

**7** Use [▲, ▼] to select the first character and press [▶].

• You can choose from the following characters:

A to Z, 0 to 9, -, &, !, /, (space)

• To delete the caption, press [\*, CANCEL].

• Repeat this step to enter the other characters.

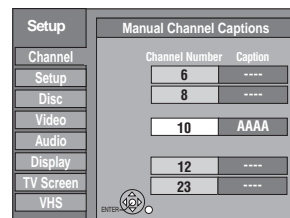

**8** Use [◀, ▶] to return to the "Channel Number" column.

• Repeat steps 6 to 8 to enter other channels.

**9** Press [ENTER].

■ To return to the previous screen

Press [RETURN].

■ To exit the screen

Press [RETURN].

## Selecting television type

You do not have to change the setting when connected to a 4:3 standard aspect TV that is not compatible with progressive output. (→ 76)

**1** While stopped

Press [FUNCTIONS].

**2** Select "Other Functions" with [▲, ▼] and press [ENTER].

**3** Select "Setup" with [▲, ▼] and press [ENTER].

**4** Select "TV Screen" with [▲, ▼] and press [◀, ▶].

**5** Select "TV Type" with [▲, ▼] and press [ENTER].

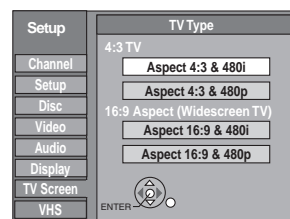

• Aspect 4:3/Aspect 16:9:



4:3 standard aspect TV

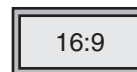

16:9 widescreen TV

• 480p/480i:

Select "480p" if the TV is compatible with progressive output.

**6** Use [▲, ▼] to select the item and press [ENTER].

■ To return to the previous screen

Press [RETURN].

■ To exit the screen

Press [RETURN].

## Television operation

To turn the TV on/off, change the TV input mode, select the TV channel and change the TV volume by means of this remote control, set the remote control as follows.

**Point the remote control at the TV**

**While pressing [POWER TV], enter the code using the numeric buttons.**

e.g., 0250: press [0] → [2] → [5] → [0].

### Manufacturer and Code No.

|            |                     |                |                     |
|------------|---------------------|----------------|---------------------|
| Panasonic  | 0051, 0250          | PHILIPS (RC-5) | 0054                |
| National   |                     | RCA            | 0047                |
| QUASAR     |                     | SAMSUNG        | 0060, 0587,<br>0702 |
| FISHER     | 0154                | SANYO          | 0154                |
| GE         | 0047                | SHARP          | 0093, 0165          |
| GOLDSTAR   | 0178, 0317,<br>0457 | SONY           | 0000                |
| HITACHI    | 0145                | SYLVANIA       | 0054                |
| JVC        | 0053                | THOMSON        | 0047                |
| LG         | 0178, 0317,<br>0457 | TOSHIBA        | 0156                |
| MAGNAVOX   | 0054                | ZENITH         | 0017                |
| mitsubishi | 0150                |                |                     |

- Test by turning on the TV and changing channels. Repeat the procedure until you find the code that allows correct operation.
- If your TV brand is not listed or if the code listed for your TV does not allow control of your TV, this remote control is not compatible with your TV.

## When other Panasonic products respond to this remote control

Change the remote control code on the main unit and on the remote control (the two must match) if you place other Panasonic products close together. When changing the remote control code, make sure the two codes are same.

Use "1", the factory set code, under normal circumstances.

- 1 While stopped**  
Press [FUNCTIONS].
- 2 Select "Other Functions" with [▲, ▼] and press [ENTER].**
- 3 Select "Setup" with [▲, ▼] and press [ENTER].**
- 4 Select "Setup" with [▲, ▼] and press [◀, ▶].**
- 5 Select "Remote Control Code" with [▲, ▼] and press [ENTER].**
- 6 Use [▲, ▼] to select the code (1, 2 or 3) and press [ENTER].**
  - The code on the unit has been set.
- 7 While pressing [ENTER], press and hold for about 2 seconds the numeric button ([1], [2] or [3]) corresponding to the code you selected in step 6.**
  - The code on the remote control has been set.
- 8 Press [ENTER].**

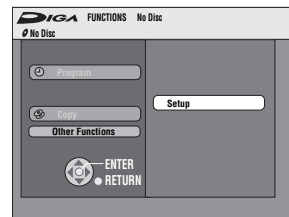

### ■ When the following indicator appears on the unit's display



The unit's remote control code

Change the code on the remote control to match the main unit's code (→ step 7).

### ■ To return to the previous screen

Press [RETURN].

### ■ To exit the screen

Press [RETURN].

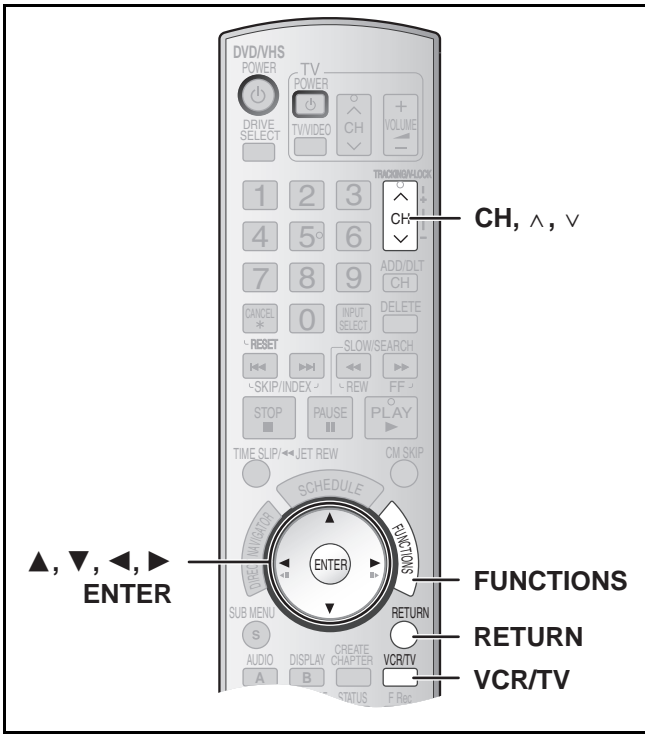

- Time Zone shows the time difference from Greenwich Mean Time (GMT).

EST (Eastern Standard Time) = GMT -5  
 CST (Central Standard Time) = GMT -6  
 MST (Mountain Standard Time) = GMT -7  
 PST (Pacific Standard Time) = GMT -8  
 AST (Alaska Standard Time) = GMT -9  
 HST (Hawaii Standard Time) = GMT -10  
 For other areas: xx hr

**8 Press [ENTER].**

**■ To cancel in the middle**

Press [RETURN].

**■ Adjust Time Zone**

- Follow steps 1 to 5 of “Clock Settings”.

Adjust the time zone (-1 or +1) if it was not set correctly with auto clock setting.

You can set this menu only after “Set Clock Automatically” is completed.

- 6 Select “Adjust Time Zone” with [▲, ▼] and press [ENTER].**

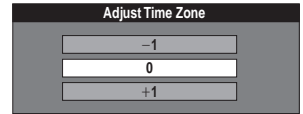

- 7 Select “-1” or “+1” with [▲, ▼] and press [ENTER].**

**■ To return to the previous screen**

Press [RETURN].

**Clock Settings**

“Clock Settings” made here are applied to VHS as well.

- 1 While stopped Press [FUNCTIONS].**

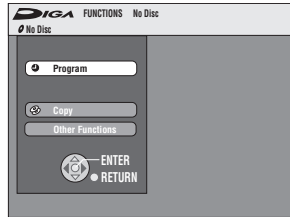

- 2 Select “Other Functions” with [▲, ▼] and press [ENTER].**  
**3 Select “Setup” with [▲, ▼] and press [ENTER].**  
**4 Select “Setup” with [▲, ▼] and press [◀, ▶].**

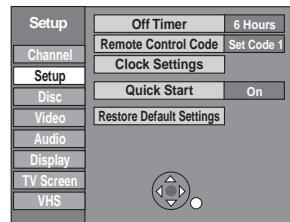

- 5 Select “Clock Settings” with [▲, ▼] and press [ENTER].**

**■ Set Clock Automatically**

- 6 Select “Set Clock Automatically” with [▲, ▼] and press [ENTER].**  
**7 Press [ENTER].**

- Auto setting starts. This can take some time, up to a few hours in some cases. The following screen appears when setting is complete.

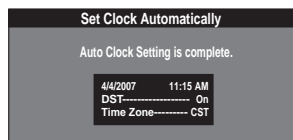

- If the time was not set correctly, use manual clock setting or time zone adjust.
- DST, (Daylight Saving Time) shows the summertime setting.

## Removing Interference

ection (without Audio/Video cable) only



attering) or a very pc  
VD Recorder is  
below to change  
) to remove th

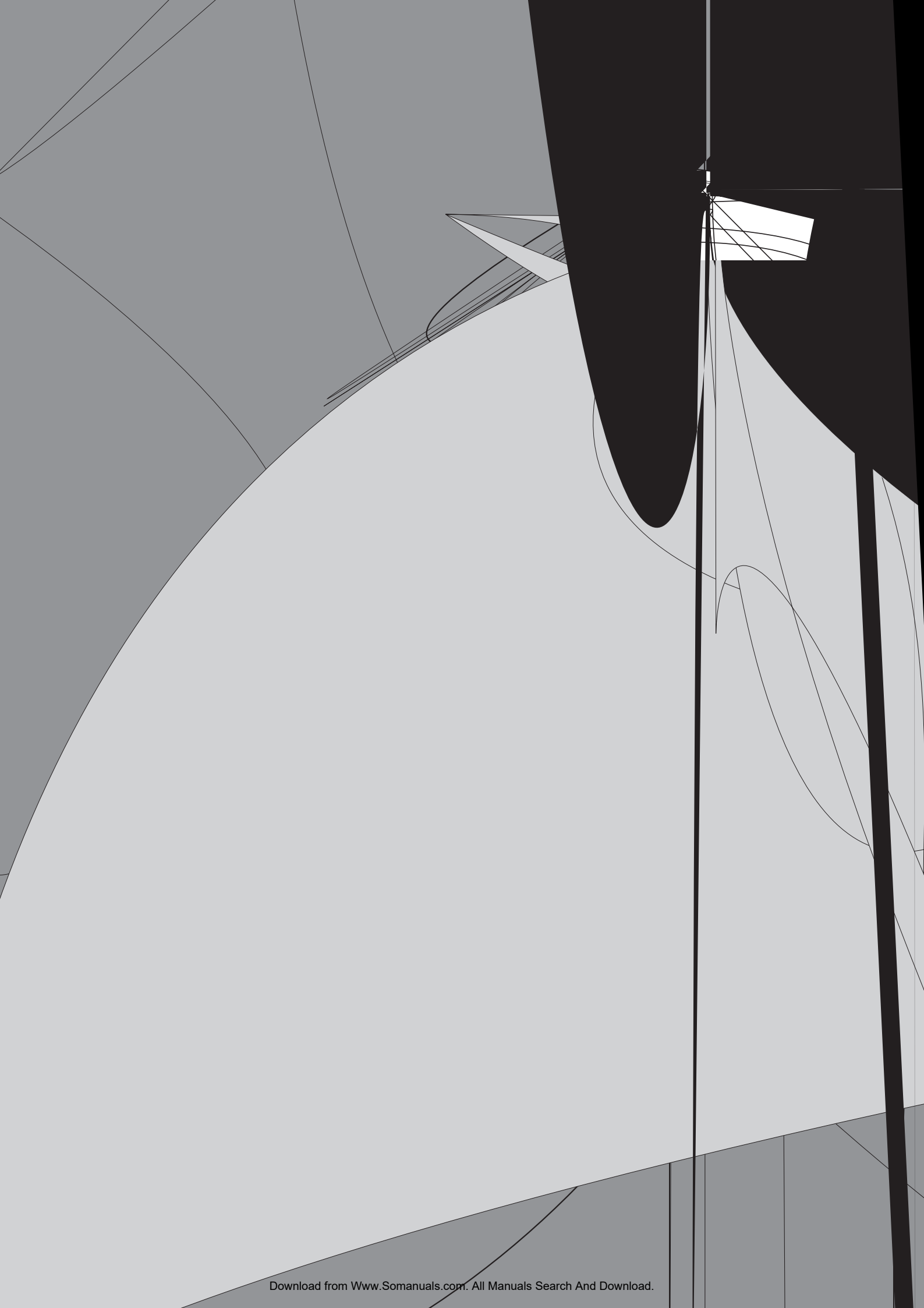



## Recording procedures

RAM -R -R DL -RW(V) +R +R DL +RW VHS

RAM -R -R DL -RW(V)

• You can record up to 99 titles on a disc.

+R +R DL +RW

• You can record up to 49 titles on a disc.

• It is not possible to record digital broadcasts that allow "One time only recording" onto DVD-R, DVD-R DL, DVD-RW, +R, +R DL, +RW or 8 cm (3") DVD-RAM discs. Use a CPRM compatible DVD-RAM.

• Recording will take place on open space on the disc. Data will not be overwritten.

• If there is no space left on the recording disc, you will need to erase unwanted titles (→ 41, 59) or use a new disc.

### When recording to DVD-R, DVD-R DL, DVD-RW (DVD-Video format), +R, +R DL or +RW

• When recording MTS broadcasts

- If you do not connect a cable box  
Select "Main" or "SAP" in "Multi-channel TV sound (MTS)" in the Setup menu (→ 64).

- If you connect a cable box  
Select "Main" or "SAP" on the cable box.

• The aspect ratio of the recorded image will be 4:3.

• To play a DVD-R, DVD-R DL, DVD-RW (DVD-Video format), +R or +R DL recorded using this unit on another playback source, the disc must first be finalized (→ 61).

• +RW To enable play on other DVD equipment, please use "Create DVD Top Menu" in DVD Management menu (→ 62).

### Preparation

• Release protection (disc → 60, cartridge → 60). RAM

• Select the unit viewing channel (e.g. AV input) on the TV.

• Select an audio type you want to record. (→ 27)

**1 Press [POWER, DVD/VHS POWER] to turn the unit on.**

**2 Press [DRIVE SELECT] to select the drive you want to record on (DVD or VHS).**

**3 Insert a disc. (→ 24)**

• When using a DVD-RAM for the first time with the unit, format it to ensure accurate recording (→ 61, "Deleting all contents of a disc or card -Format").

or

**Insert a video cassette with an intact accidental erasure prevention tab. (→ 24)**

**4 Press [CH, ^, v] to select the channel.**

• To select with the numeric buttons:



### Antenna Mode (Airwaves)

e.g., "5": [0]→[5]

"15": [1]→[5]

### CableTV Mode (Cable)

e.g., "5": [0]→[0]→[5]

"15": [0]→[1]→[5]

"115": [1]→[1]→[5]

**5 Press [REC MODE] to select the recording mode.**



Remaining time on the disc

DVD

XP, SP, LP or EP

VHS

SP, EP or VP

**6 Press [●, REC] to start recording.**



• You cannot change the channel or recording mode during recording. You can change them while recording is paused, but the material is recorded as a separate title.

### To pause recording

Press [PAUSE]. (Press again to restart recording.)

• Title is not split into separate titles. DVD

• You can also press [●, REC] to restart recording.

### To stop recording

Press [STOP].

• Recorded as 1 title until the position where stopped. DVD

• -R -R DL -RW(V) +R +R DL +RW

It takes about 30 seconds for the unit to complete recording management information after recording finishes.

### To show the remaining time

DVD

Press [STATUS] several times. (→ 40)

VHS

**1** Select "Select Tape Length" from the Setup and select the corresponding tape length. (→ 65)

**2** Press [STATUS] several times.

The remaining tape time may not be displayed correctly depending on the tape used.

### Notes

• Even if the video cassette you use is labeled "S-VHS", it is not possible to record in the S-VHS system with the unit. It records in the normal VHS system. VHS

• When recording is paused for 5 or more minutes, the unit returns to stop mode. VHS

• The remaining tape time is only displayed during playback or recording. VHS

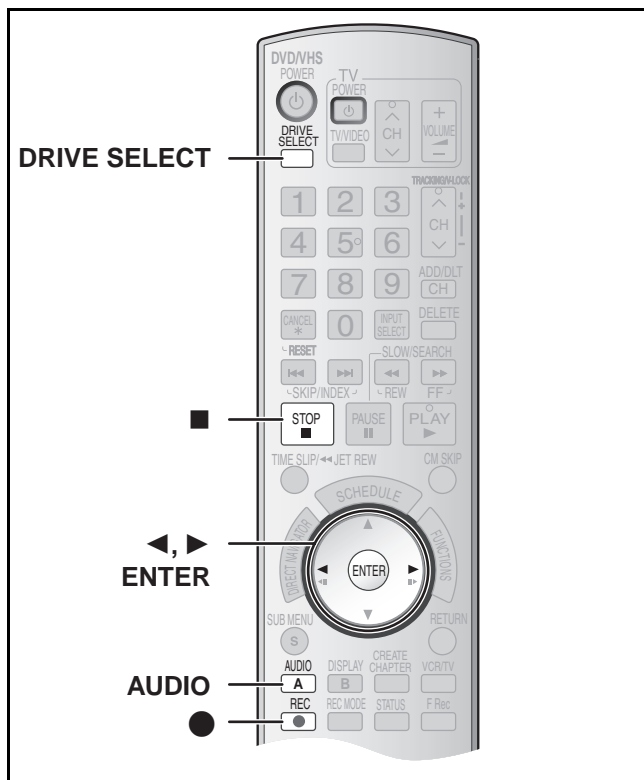

## Recording modes and approximate recording times (DVD)

Depending on the content being recorded, the recording times may become shorter than indicated.

|                           | DVD-RAM               |                              | DVD-R DVD-RW +R, +RW (4.7 GB) |
|---------------------------|-----------------------|------------------------------|-------------------------------|
|                           | Single-sided (4.7 GB) | Double-sided*1 (9.4 GB)      |                               |
| XP (High quality)         | 1 hour                | 2 hours                      | 1 hour                        |
| SP (Normal)               | 2 hours               | 4 hours                      | 2 hours                       |
| LP (Long recording)       | 4 hours               | 8 hours                      | 4 hours                       |
| EP (Extra long recording) | 8 hours (6 hours*2)   | 16 hours (12 hours*2)        | 8 hours (6 hours*2)           |
| FR (Flexible Recording)   | 8 hours maximum       | 8 hours maximum for one side | 8 hours maximum               |

|                           | DVD-R DL, +R DL*3 (8.5 GB)                |   |
|---------------------------|---|---|
|                           | First layer                               | Second layer                              |
| XP (High quality)         | 55 minutes                                | 50 minutes                                |
| SP (Normal)               | 1 hour 50 minutes                         | 1 hour 40 minutes                         |
| LP (Long recording)       | 3 hours 40 minutes                        | 3 hours 20 minutes                        |
| EP (Extra long recording) | 7 hours 25 minutes (5 hours 30 minutes*2) | 6 hours 50 minutes (5 hours 15 minutes*2) |
| FR (Flexible Recording)   | 7 hours 25 minutes maximum                | 6 hours 50 minutes maximum                |

This unit uses variable bit rate (VBR) recording which varies the amount of data recorded to suit the images, so actual recording times and remaining recording times shown by the unit will be different. (The difference will be especially noticeable with DVD-R DL and +R DL.)

Use a disc with plenty of remaining time to be sure.

\*1 It is not possible to record or play continuously from one side of a double sided disc to the other.

\*2 When "Recording Time in EP Mode" has been set to "EP (6H)" in the Setup menu. (→ 64)  
The sound quality is better when using "EP (6H)" than when using "EP (8H)".

\*3 It is not possible to record continuously from first layer to second layer.

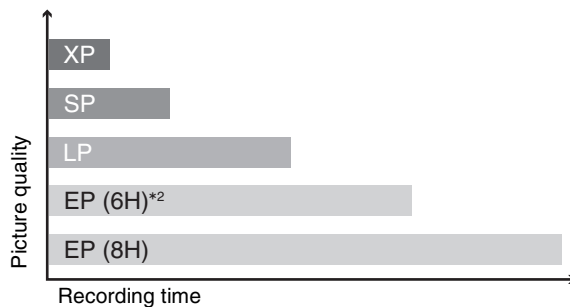

### Note

When recording to DVD-RAM using EP (8H) mode, play may not be possible on DVD players that are compatible with DVD-RAM. In this case use EP (6H) mode.

### FR (Flexible Recording mode → 29):

- You can set FR mode when transferring (copying) or programming scheduled recordings.

## Recording modes (VHS)

### Recording mode

SP: You can record the length shown on the tape.

EP: 3 times the length of SP mode.

VP: 5 times the length of SP mode.

- To have a longer recording capacity, select "EP" or "VP".
- If the image quality is important to you or if you wish to store the tape for a long period, select "SP".
- The unit can play tapes recorded in LP mode on other equipment ("LP" lights on the unit's display).

### VP mode:

- A tape recorded in VP mode by the unit cannot be played back by other VCRs. It is recommended to distinguish it from other tapes by writing "VP" on the tape label, etc.
- It takes more time for automatic tracking to work when playing tapes recorded with VP mode, and it may not work at all with some tapes. Do tracking manually if this is the case (→ 38).

### Note

You cannot play VP recording on other equipment.

## ■ Off Timer

The unit automatically switches to standby when it has not been used for about 6 hours.

You can turn this feature off or change the time to 2 hours. (→ 63, “Off Timer”)

## ■ When the format confirmation screen is displayed

**RAM** **-RW(V)** **+R** **+R DL** **+RW**

When you insert a new disc and a disc recorded on a computer or other equipment, a format confirmation screen might be displayed. Format the disc to use it. However all the recorded contents are deleted.

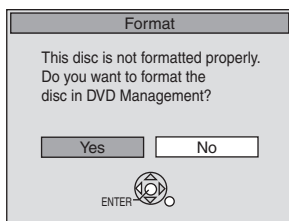

Press [**◀**, **▶**] to select “Yes” and press [**ENTER**].

- Several steps are necessary to format a disc. Refer to “Deleting all contents of a disc or card –Format”. (→ 61)

## ■ When remove a recorded disc

**-R** **-R DL** **-RW(V)** **+R** **+R DL**

When you press [**▲**, OPEN/CLOSE] on the main unit while stopped: The following screen appears when you have not processed the disc for play on other equipment.

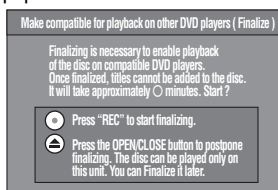

**When finalizing the disc**

Press [**●**, REC].

- You cannot stop this process once you have started it.
- If you want to provide the disc with a name or set play menu select, select “Disc Name” (→ 60) or “Playback will start with” (→ 61) in “DVD Management” before finalizing.

**When opening the tray without disc finalization**

Press [**▲**, OPEN/CLOSE] on the main unit.

## To specify a time to stop recording –One Touch Recording

**While recording**

**1** Press [**DRIVE SELECT**] to select the drive you want to specify the time to stop recording (DVD or VHS).

**2** Press [**●**, REC] to select the recording time.

- On the main unit, press [**●**, REC].

**The unit’s display**

Each time you press the button:

Counter (Cancel) → OFF 0:30 → OFF 1:00 → OFF 1:30  
 ↑ OFF 4:00 ← OFF 3:00 ← OFF 2:00 ←

**For your reference**

- This does not work during scheduled recording or Flexible Recording.
- Recording stops and the set time is cleared if you press [**■**, STOP].
- The set time is cleared if you change the recording mode or channel while recording is paused. **DVD**

## Selecting audio to record

**RAM**

Press [**AUDIO**].

Stereo → SAP Audio → Mono

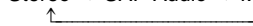

|                   |   |
|-------------------|---|
| <b>Stereo:</b>    | Main audio (stereo). If the broadcast is “Mono+SAP”, audio will be monaural even if you select Stereo mode. |
| <b>SAP Audio:</b> | Secondary audio program (SAP). If recorded in SAP, main audio is also recorded.                             |
| <b>Mono:</b>      | Main audio (monaural). Select “Mono” if reception is poor during a stereo broadcast.                        |

CH 12

- If you change the sound setting while recording, the recorded sound will also change.

**-R** **-R DL** **-RW(V)** **+R** **+R DL** **+RW**

Select the audio (Main or SAP) in “Multi-channel TV sound (MTS)” in the Setup menu. (→ 64)

## Auto Bilingual Choice Function

**VHS**

When a stereo broadcast or SAP broadcast is recorded and played back on the unit, stereo sound will be automatically selected in the case of a stereo broadcast and SAP sound will be automatically selected in the case of a dual-sound broadcast (Mono and SAP or Stereo and SAP).

- This function may not work properly if the program is played back from a mid point. In a case like this, press [**AUDIO**] and select the right sound.
- The function will not work with a cassette which has been recorded using external equipment.



## Flexible Recording

(Recording that fits the remaining disc space)

RAM -R -R DL -RW(V) +R +R DL +RW

The unit calculates a recording rate that enables the recording to fit in the time you set (within the remaining time on the disc) with the best picture quality.

Using "FLEXIBLE RECORDING" is convenient in these kind of situations.

- When the amount of free space on the disc makes selecting an appropriate recording more difficult
- When you want to record a long program with the best picture quality possible

e.g., Recording a 90 minute program to disc

If you select XP mode, the program will not fit one disc.



A second disc is necessary for 30 minutes of the program.

If you select SP mode, the program will fit one disc.



However there will be 30 minutes remaining disc space



If you select "FLEXIBLE RECORDING" the program will fit one disc perfectly.

### Preparation

- Select DVD side with pressing [DRIVE SELECT].
- Select the channel to record.

#### 1 While stopped

Press [F Rec].



Maximum recording time  
This is the maximum recording time in FR mode.

#### 2 Press [◀, ▶] to select "Hour" and "Min." and press [▲, ▼] to set the recording time.

- You can also set the recording time with the numbered buttons.
- You cannot record for more than 8 hours.

#### 3 When you want to start recording

Press [▲, ▼, ▶, ▶] to select "Start" and press [ENTER].

- Recording starts.

### To exit the screen without recording

Press [RETURN].

### To stop recording partway

Press [■, STOP].

### To show the remaining time

Press [STATUS] several times. (→ 40)

### For your reference

- During a Flexible Recording, all recording mode indicators light up on the unit's display.
- It is not possible to change the channel or recording mode while Flexible Recording is paused.

# Scheduled Recording

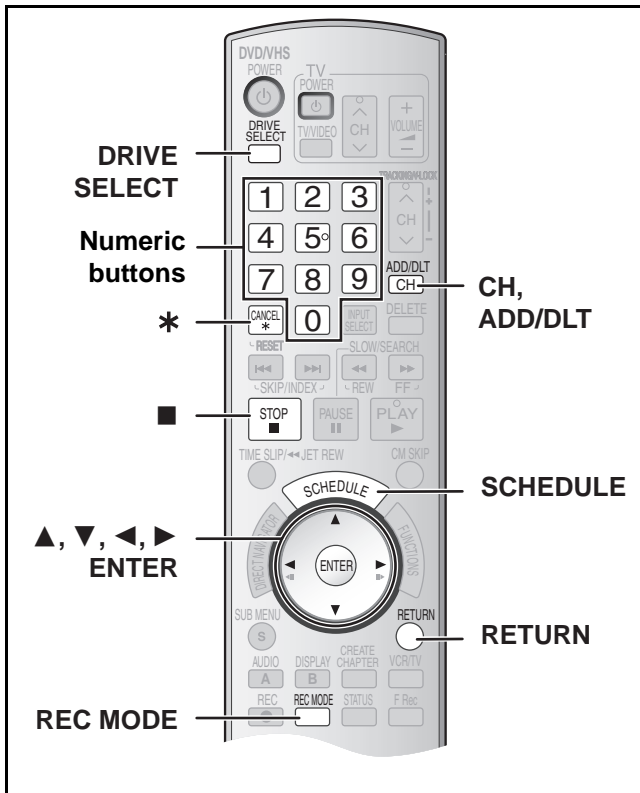

## Cautions for using scheduled recording on DVD and VHS

- **Scheduled recording automatically starts at the set time.**
  - Scheduled recording can be started whether the unit is turned on or off. When the unit is turned off, the sound and the video cannot be outputted to the TV.

- **Scheduled recording for TV programs cannot be executed on both DVD and VHS at the same time.**

Make sure the scheduled recording start times do not overlap on both DVD and VHS Scheduled Recording List screens.

When the scheduled recording settings overlap:

- When the start time of both scheduled recordings is the same, the programme that you register later has priority.
- If there is a VHS scheduled recording that overlaps a DVD scheduled recording that is currently being recorded, it may not be possible to operate the VHS during the overlap.

## Programming scheduled recordings

**RAM -R -R DL -RW(V) +R +R DL +RW VHS**

You can enter up to 16 programs a month in advance.

### Preparation

- Release protection (disc → 60, cartridge → 60) **RAM**.
- Insert a disc (→ 24) and confirm there is sufficient empty space for recording on it (→ 40).
- Check that the clock is set to the correct time.
- When connecting a cable box or satellite receiver, select the channel on the cable box or satellite receiver before scheduled recording starts.

### 1 Press [SCHEDULE].

- Make sure "New Scheduled Recording" is selected.

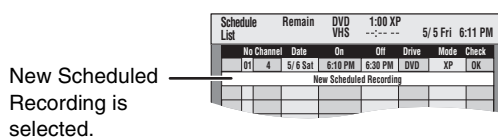

### 2 Press [ENTER], to move and change the items using [▲, ▼, ◀, ▶].

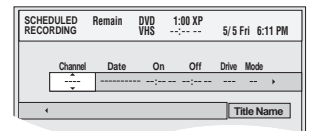

- You may use the numeric buttons to enter "Channel", "Date", "On", and "Off".
- **Channel** (Program Position/TV Station Name)
- **Date**
  - You can also make a daily or weekly program. Each daily or weekly program is counted as one program.
- **On** (start time)/**Off** (finish time)
  - The time increases or decreases in 30-minute intervals if you hold down the button.
- **Drive**
  - You can select DVD or VHS drive. You can also press [DRIVE SELECT] to select the drive. DVD ↔ VHS
- **Mode** (Recording mode)
  - You can also press [REC MODE] to change the recording mode.
    - DVD** XP ↔ SP ↔ LP ↔ EP ↔ FR ↔ XP.. (→ 26)
    - VHS** SP ↔ EP ↔ VP ↔ AUTO\* ↔ SP.. (→ 26)
    - \*Auto SP/EP mode (→ 31)
- **Title Name**
  - Press [◀, ▶] to select "Title Name" and press [ENTER] (→ 58).

### 3 Press [ENTER] when you have finished making changes.

- "⊖" lights on the unit's display. (→ 13)
- "Invalid Entry" is displayed when you enter the wrong item. Reenter the item.
- Make sure that the scheduled recording has been programmed correctly on the SCHEDULE LIST screen (→ 31).
- To continue programming:
  - Select "New Scheduled Recording" and repeat steps 2 to 3.

### 4 Press [RETURN].

### Notes

- When the unit is carrying out a scheduled recording, you may utilize playback.
- When the disc or video cassette is removed, scheduled recording standby is cancelled (the "⊖" indicator goes out). You can put the unit back on standby by inserting a recordable disc or video cassette (the "⊖" indicator comes on again).
- When a video cassette is not inserted or a video cassette with no accidental erasure prevention tab is inserted, the warning message appears before the recording starts because scheduled recording cannot be executed.
- When recording more than one program in a row, for DVD-RAM the first few seconds, and for DVD-R, DVD-R DL, DVD-RW, +R, +R DL or +RW about the first 30 seconds of all programs from the second one onwards will not be recorded.
- Even if you set the Title Name on the scheduled recording screen, it is not recorded on video cassette.
- If you set "DST" (Daylight Saving Time) to "ON" when manually setting the clock (→ 19), scheduled recording may not work when summer switches to winter and vice versa.

## Preparation

- Select the drive with the scheduled recording you want to cancel by pressing [DRIVE SELECT].

### 1 When unit is on

Press [■, STOP].

- Confirmation screen appears.

### 2 Press [◀, ▶] to select “Stop Recording” and press [ENTER].

- Recording stops and the scheduled recording is deleted. (Daily and weekly schedules remain and scheduled recording will start as programmed.)

### 1 Press [SCHEDULE].

### 2 Press [▲, ▼] to select the program and press [SUB MENU].

### 3 Press [▲, ▼] to select “Schedule set to Off” and press [ENTER].

- Cancelled icon is displayed in left column.

- Be sure to select “Schedule set to On.” in step 3 before the scheduled time to put the program on recording standby.

## Note

- When a scheduled recording program cannot start (no tape, etc.), “Schedule set to On.” is cancelled one minute before the start time. (If a daily or weekly scheduled recording program cannot start, the following daily or weekly scheduled recording will not be affected.)

### VHS

### VHS

If, at the beginning of a scheduled recording, there is not enough tape remaining to complete the recording, the SP/EP function will automatically run the tape at EP speed for recording. This ensures that the entire program will be recorded. If EP mode is not enough to stretch the remaining tape to fit the whole program you will not be able to record the whole TV program.

- It is not possible to automatically activate VP mode.
- The tape length must be set correctly. (→ 65)
- Some tapes may not work correctly.
- If the recording mode changes from SP to EP during a scheduled recording, some picture distortion occurs at that point.

Even when the unit is turned off, you can display the scheduled recording list by pressing [SCHEDULE].

### 1 Press [SCHEDULE].

## Icon explanations (Ⓐ)

- : Currently recording
- Ⓜ: Programs are overlapped. Recording of the program with the later start time starts when the earlier program finishes recording.
  - : Scheduled recording standby is cancelled. Recording will not start at the scheduled time.
- Ⓞ: You stopped a weekly or daily scheduled recording. The icon disappears when the next scheduled recording starts.
- Ⓢ: The disc was full. (not enough space)
  - : The TV program may not be recorded due to copy-protect. (disc)
- Ⓧ: Recording stopped (Dirty disc or tape, etc.)

## Check (ⓑ)

OK: Recordable (disc)

→ (Date): The last day of daily or weekly recording. (disc)

!: It may not be possible to record because:

- the disc is write-protected.
- there is no more space left (disF3 1 Tf-1.240 F3 1 Tf-1.240 F3 1 Tf6)



## Preparation

- Turn on the TV and select the appropriate video input to suit the connections to the unit.

## Playing discs

**RAM -R -R DL -RW(V) +R +R DL +RW DVD-A DVD-V**  
**-RW(VR) VCD CD**

- 1 Press [**POWER**, DVD/VHS POWER] to turn the unit on.
- 2 Insert a disc. (→ 24)
- 3 Press [**DRIVE SELECT**] to select the DVD drive.
- 4 Press [**▶**, PLAY].

- The disc tray closes and play begins.  
(The unit takes some time to read the disc before play starts.)
- Playback starts from the most recently recorded title.
- **RAM -R -R DL -RW(V) +R +R DL +RW -RW(VR)**  
Playback starts from the beginning of the disc.

**DVD-A DVD-V VCD CD**

### ■ To stop play

Press [**■**, STOP].

The stopped position is memorized.

### Resume play function

Press [**▶**, PLAY] to restart from this position.

- Depending on the disc, resume play function may not be effective.

**VCD**

- The stopped position is cleared when:
  - You press [**■**, STOP] several times.
  - You open the tray.
  - You turn the unit off. **DVD-A VCD CD**
- The screen saver on the right may appear when you stop play. Press [**■**, STOP] again and you can use the unit's tuner to watch TV.

**DVD-A DVD-V VCD CD**

### ■ To pause play

Press [**⏸**, PAUSE]. (Press again to restart play.)

### Notes

- The unit stops playing a disc when scheduled recording starts.  
**RAM -R -R DL -RW(V) +R +R DL +RW**
- Press [**▶**, PLAY] when you wish to start playing the disc while recording (→ 28, "Playing from the beginning of the title you are recording—Chasing playback"). **RAM**

**VCD**

Press the numeric buttons to select an item.

e.g.: "5": [0]→[5]  
 "15": [1]→[5]

**DVD-A DVD-V**

Press [**▲**, **▼**, **◀**, **▶**] to select an item and press [ENTER].

- You can sometimes use the numeric buttons to select an item.

### Other buttons used to operate menus

Read the disc's instructions for further details about operation.

### Note

- If " " appears on the TV, the operation is prohibited by the unit or disc.

**RAM -R -R DL -RW(V) +R +R DL +RW -RW(VR)**

### 1 Press [DIRECT NAVIGATOR].

### 2 Use [**▲**, **▼**, **◀**, **▶**] to select the title you want to watch and press [ENTER].

- Play starts.
- You can also select titles by entering a 2-digit number with the numeric buttons.  
e.g.: "5": [0]→[5]  
"15": [1]→[5]
- **RAM** Press [A] to switch to the Title View screen, when the Album View screen is displayed.
- If you enter a number larger than the total number of titles, the last title is selected.
- "To show other pages" (→ 41)

### ■ To exit the Title View screen

Press [RETURN].

### For your reference

- Direct Navigator screen icons
  - : Title protected
  - : Copy-protected so it was not recorded
  - x: Unable to play
  - : Currently recording
  - : Title with "One time only recording" restriction (→ 76, CPRM)

**RAM**

The play speed can be increased without distorting the audio.

### During Play

Press and hold [**▶**, PLAY].

### ■ To return to normal speed

Press [**▶**, PLAY].

**RAM -R -R DL -RW(V) +R +R DL +RW DVD-A DVD-V**  
**-RW(VR) VCD CD**

### During Play

Press [**◀◀**, SLOW/SEARCH] or [**▶▶**, SLOW/SEARCH].

- There are 5 search speeds. Each press increases the search speed. (**+R +RW** Up to 3 speeds)
- Press [**▶**, PLAY] to restart playback.

### For your reference

- Sound is output only in the first level of fast forward. In the case of DVD-Audio (except motion picture parts), CD and MP3, it is output in all levels.
- Depending on the disc, search may not be possible.



## Skipping

RAM -R -R DL -RW(V) +R +R DL +RW DVD-A DVD-V  
-RW(VR) VCD CD

During play or while paused

Press [**◀◀**, SKIP] or [**▶▶**, SKIP].

- Each press increases the number of skips.

## Slow-motion play

RAM -R -R DL -RW(V) +R +R DL +RW  
DVD-A (Motion picture parts only) DVD-V -RW(VR) VCD

While paused

Press [**◀◀**, SLOW/SEARCH] or [**▶▶**, SLOW/SEARCH].

- When slow motion play is continued for about 5 minutes it pauses automatically (excluding DVD-A DVD-V VCD).
- There are 5 play speeds. Each press increases the play speed.
- Press [**▶**, PLAY] to restart playback.
- **VCD** Forward direction ([**▶▶**, SLOW/SEARCH]) only.

## Frame-by-frame viewing

RAM -R -R DL -RW(V) +R +R DL +RW  
DVD-A (Motion picture parts only) DVD-V -RW(VR) VCD

While paused

Press [**◀◀◀**] ([**◀◀**]) or [**▶▶▶**] ([**▶▶**]).

- Each press shows the next or previous frame.
- Press and hold to change in succession forward or backward.
- Press [**▶**, PLAY] to restart playback.
- **VCD** Forward direction ([**▶▶▶**], [**▶▶**]) only.

## Direct play

RAM -R -R DL -RW(V) +R +R DL +RW DVD-A DVD-V  
-RW(VR) VCD CD

You can play from the title, chapter or track you select.

During Play

Press the numeric buttons to select an item.

**CD** (MP3, JPEG and TIFF disc only)

e.g.: "5": [0]→[5] "5": [0]→[0]→[5]  
"15": [1]→[5] "15": [0]→[1]→[5]

**DVD-A**

A group number can be specified while the screen saver (→ 32) is displayed.

e.g.: "5": [5]

- This works only when stopped (screen saver is displayed) with some discs.
- **Playing bonus groups**  
Some discs contain bonus groups. If a password screen appears after selecting a group, enter the password with the numeric buttons and press [ENTER]. For the password, refer to the disc's jacket, etc.

## CM Skip

RAM -R -R DL -RW(V) +R +R DL +RW -RW(VR)

You can skip approximately 1 minute with one press.

During play

Press [**CM SKIP**].

## Create chapters

RAM

During play

Press [**CREATE CHAPTER**].

- Press [**◀◀**, SKIP] or [**▶▶**, SKIP] to skip to the start of a chapter.
- You cannot activate this function when you are carrying out transfer (copy).

## Skipping the specified time — Time Slip

RAM -R -R DL -RW(V) +R +R DL +RW -RW(VR)

1 During play  
Press [**TIME SLIP**].

2 Press [**▲**, **▼**] to select the time and press [**ENTER**].

Play skip to the specified time.

- Each time you press [**▲**, **▼**] the time increases [**▲**] or decreases [**▼**] by 1 minute intervals. (Press and hold for 10-minute intervals.)

## Changing audio during play

Press [**AUDIO**] to select the audio type.

- You can select audio types depend on the recording medium.

RAM -RW(VR) VCD  
Stereo → Mono L → Mono R

e.g.: **RAM**  
"Stereo" is  
selected.



RAM -RW(VR) [When playing an SAP broadcast recorded on DVD-RAM, DVD-RW (DVD Video Recording format)]  
MAIN Audio ↔ SAP Audio

DVD-A DVD-V

This allows you to change items like the audio channel number and the sound track language. (→ 39)



e.g.: English is the selected language. **DVD-V**

**VHS**

Stereo → Mono L → Mono R → No display (Normal audio track)

### Note

- If you cannot change the audio type when you have used only an optical digital cable for connection, set "Dolby Digital" to "PCM" (→ 64). Alternatively, you may connect to an amplifier with an Audio/Video cable and change the input on the amplifier to suit the connection.

# Using menus to play MP3 and still pictures (JPEG/TIFF)

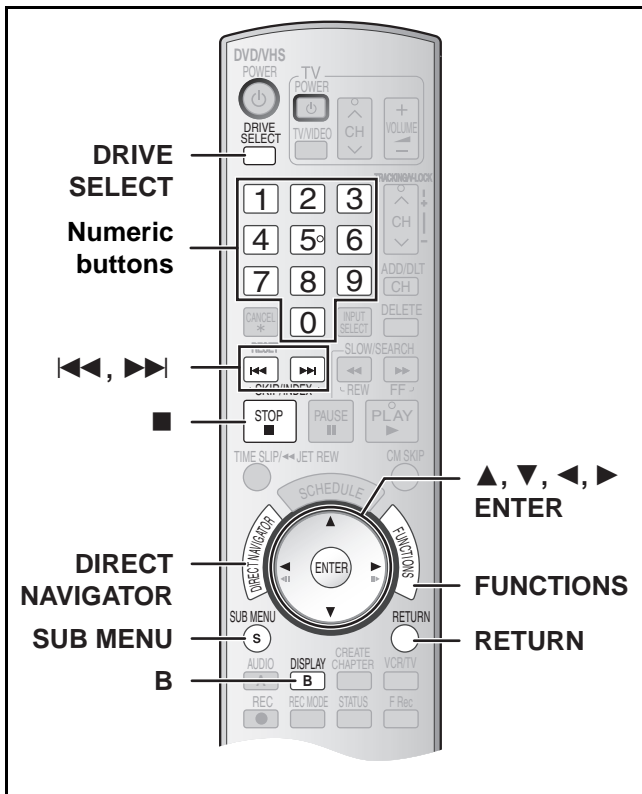

## Preparation

- Turn on the TV and select the appropriate video input to suit the connections to the unit.
- Select DVD side with pressing [DRIVE SELECT].

## Playing discs which contain both MP3 and still pictures

### CD

The screen shown below is displayed when you insert a disc containing MP3 files and still pictures (JPEG/TIFF).

Press [ENTER].

### To play MP3

Refer to "Playing MP3". (→ below)

### To play still pictures

Refer to "To show Pictures Menu". (→ 35)

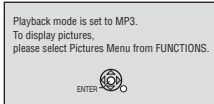

## Playing MP3

### CD

The unit plays MP3 files recorded on CD-R/RW designed for audio recording that are finalized (→ 76) on a computer. Files are treated as tracks and folders are treated as groups.

### 1 During stop or play

Press [DIRECT NAVIGATOR].

- The file list appears.

Selected Group No. and Name

**G:**

The Group Number

**T:**

Track Number in the Group

**Total:**

Selected Track Number/  
Total Track Number

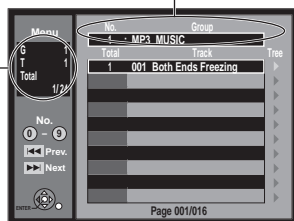

### 2 Press [▲, ▼] to select the track and press [ENTER].

- Play starts on the selected track.
- "□" indicates the track currently playing.
- You can also directly select the track with the numeric buttons. e.g.:

"6": [0]→[0]→[6]

"10": [0]→[1]→[0]

### Using the tree screen to find a group (→ right)

### To show other groups

Press [◀] (Prev.) or [▶] (Next) to show other pages.

- After listing all the tracks in one group, the list for the next group appears.

### To exit the file list

Press [DIRECT NAVIGATOR] or [RETURN].

### Regarding MP3

- Compatible formats: ISO9660 level 1 or 2 (except for extended formats) and Joliet
- Maximum number of files (tracks) and folders (groups) recognizable: 999 files\* (tracks) and 99 (including the root folder) folders (groups)
- \* Total number for all the MP3, JPEG and other types of files
- This unit is compatible with multi-session but reading or play of the disc may take time if there are a lot of sessions.
- Operation may take time to complete when there are many files (tracks) and/or folders (groups) and some files (tracks) may not display or be playable.
- The display order on this unit may differ from how the order is displayed on a computer.
- Depending on how you create the disc (writing software), files (tracks) and folders (groups) may not play in the order you numbered them.
- This unit is not compatible with packet-write format.
- Depending on the recording, some items may not be playable.
- File format: MP3  
Files must have the extension ".mp3" or ".MP3".
- Bit rates: 32 kbps to 320 kbps
- Sampling frequency: 16 kHz/22.05 kHz/24 kHz/32 kHz/44.1 kHz/48 kHz
- This unit is not compatible with ID3 tags.
- If there is a large amount of still picture data etc. within a MP3 file, play may not be possible.

- You can play MP3 on this unit by making folders as shown below. However depending on how you create the disc (writing software), play may not be in the order you numbered the folders.
- English alphabetical characters and Arabic numerals are displayed correctly. Other characters may not be displayed correctly.
- When the highest level folders are "DCIM" folders, they are displayed first on the tree.

### Structure of MP3 folders

Prefix with 3-digit numbers in the order you want to play them.

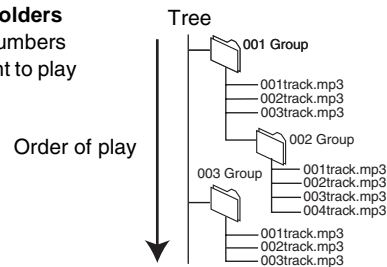

### Using the tree screen to find a group

#### 1 While the file list is displayed (→ left)

Press [▶] while a track is highlighted to display the tree screen.

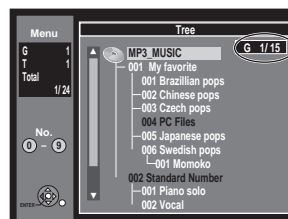

### Selected Group Number/Total Group Number

- If the group has no track, "—" is displayed as group number.

- A folder which has no MP3 files is indicated in black. You cannot select groups with no MP3 files.
- Press [◀, ▶] to jump layers in the tree screen.

#### 2 Press [▲, ▼] to select a group and press [ENTER].

- The file list for the selected group appears.

### To return to the file list

Press [RETURN].

- 1** Press [FUNCTIONS].
- 2** Select “Menu” with [▲, ▼] and press [ENTER].
- 3** Select “Pictures” with [▲, ▼] and press [ENTER].

#### **Press [DIRECT NAVIGATOR].**

##### **■ To show other pages**

Press [◀◀] (Previous) or [▶▶] (Next) to show other pages.

- You can also press [▲, ▼, ◀, ▶] to select “Previous” or “Next” and press [ENTER] to show other pages.

##### **■ To exit the Pictures Menu**

Press [DIRECT NAVIGATOR] or [RETURN].

**RAM**



# Playing a video cassette

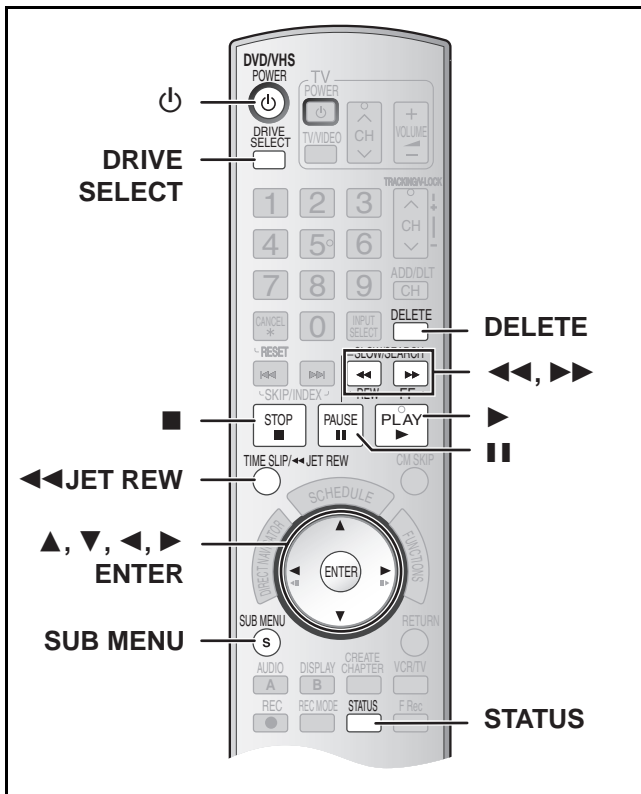

- 1 Press [⏻, DVD/VHS POWER] to turn the unit on.
- 2 Select VHS side with pressing [DRIVE SELECT].
- 3 Select the unit viewing channel (e.g. the AV input) on the TV.
- 4 Insert a recorded video cassette. (→ 24)
- 5 Press [▶, PLAY].

- Play starts automatically if you insert a video cassette with the tab removed.

#### ■ To pause play

Press [⏸, PAUSE]. (Press again to restart play.)

#### ■ To stop play

Press [■, STOP].

#### Notes

- When the unit is on standby, an inserted video cassette can be played back by pressing [▶, PLAY].
- When the tape reaches its end, the unit automatically rewinds it to the beginning. This function does not work during scheduled recording, fast-forwarding and specified stop recording.
- Jet Search, cue, review or slow playback will be automatically canceled after 10 minutes, and pause after 5 minutes.
- When viewing a still picture or during slow playback, the picture that appears in VP mode may be distorted.
- When playing back a tape which was recorded on another VCR, it may be necessary to adjust the tracking (→ 38). In some cases the picture quality may still be inferior. This is due to format constraints.

## Fast-forward/Rewind

While stopped

Press [◀◀] (backward)/[▶▶] (forward).

## Cue/Review

During play

Tap or keep pressing [◀◀] (backward)/[▶▶] (forward).

- If you keep pressing these buttons, normal playback restarts by releasing them.
- Tap [▶, PLAY] to restart normal playback.

## Jet Search

During play

Tap [◀◀] (backward)/[▶▶] (forward) twice. You can increase Cue/Review search speed.

- Press [▶, PLAY] to restart normal playback.
- You can select search speed to view the recorded picture. (→ 65)
- The picture recorded in EP or VP mode may be distorted if it is played at approx. 35 times speed. A vertical scroll may occur. It is not a malfunction but if it happens, change to approx. 27 times speed.
- The picture may not be in color or may be distorted depending on the TV.

## Slow

During play

Press and hold [⏸, PAUSE] for about 2 seconds or more.

- Press [▶, PLAY] to restart normal playback.

## Jet Rewind

To perform a Higher Speed Rewind

Press [◀◀JET REW].

- Depending on the tape or an operating condition, the rewind speed may change somewhat.
- The tape counter is reset to "0:00.00" when the tape is rewound to the beginning.
- Depending on the tape, this function may not work.

## S-VHS Quasi Playback (SQPB)

It is also possible to play back tapes recorded in the S-VHS system.

- Some picture noise may occur depending on the type of tape used.
- It is not possible to fully obtain the high resolution that S-VHS is capable of.
- It is not possible to record in the S-VHS system with the unit.

## Repeat Playback

During play or while stopped

Keep pressing [▶, PLAY] for about 5 or more seconds.

- At the end of the program, the tape rewinds to the beginning of the program and plays it again (it only works if there is at least 5 seconds blank space at the end of the program). This repeats until you cancel it.

#### ■ To restart normal playback

Press [▶, PLAY].

#### ■ To stop play

Press [■, STOP].

## On-screen display indications

The following information appears during play on VHS.

To view the on-screen display, set the "Status Messages" item in the "Setup" menu to "On".

The following details appear on the screen.

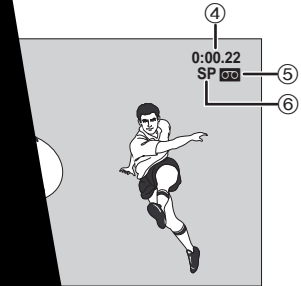

The Right (Mono R) indicators show the selected audio track. The indicators are selected as follows:

- When the Right (Mono R) indicator appears.
- When the Left (Mono L) indicator appears.
- When the Stereo (Stereo) indicator appears.
- When the Mono L nor R indicator appears.

### Remaining tape time

Pressing the **Remaining tape time** button repeatedly to change the on-screen display.

→ Remaining tape time

The tape counter (elapsed time) is automatically reset when a new video cassette is inserted. It will be incorrect if the "Select Tape Length" in the "Setup" menu is set to "Auto" quality. (→ 65)

Pressing the **Remaining tape time** button repeatedly to change the on-screen display.

Depending on the

## Using on-screen menus

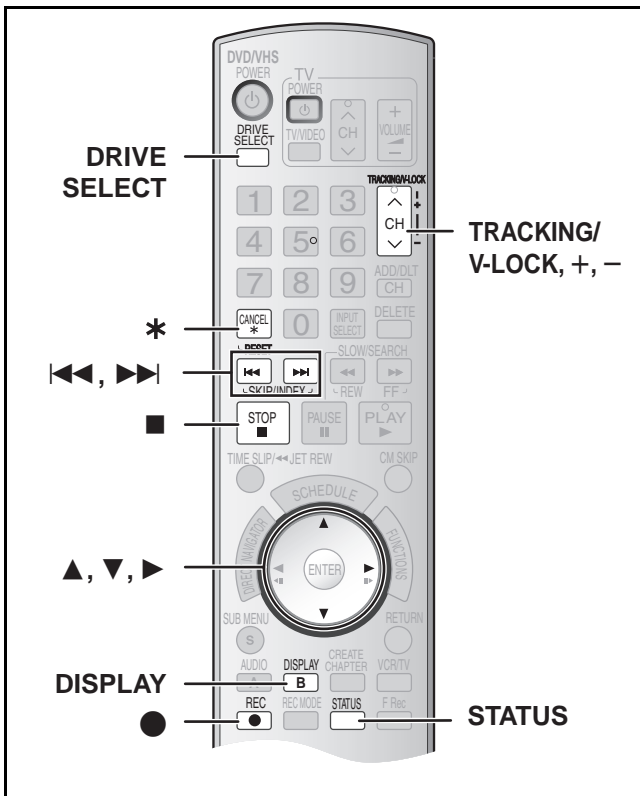

### Common procedures

RAM -R -R DL -RW(V) +R +R DL +RW DVD-A DVD-V  
-RW(VR) VCD CD

#### Preparation

- Select DVD side with pressing [DRIVE SELECT].

#### 1 Press [DISPLAY].

|       |               |        |                  |
|-------|---------------|--------|------------------|
| Disc  | Soundtrack    | 1      | DD Digital 2/0ch |
| Play  | Subtitle      | Off    |                  |
| Video | Audio channel | Stereo |                  |
| Audio |               |        |                  |
| Other |               |        |                  |

Menu                      Item                      Setting

#### 2 Select a menu with [▲, ▼] and press [▶].

#### 3 Select an item with [▲, ▼] and press [▶].

#### 4 Select a setting with [▲, ▼].

- Different operations are required depending on settings. Follow the on-screen instructions.

### To exit the screen

Press [DISPLAY].

#### For your reference

- The screens depend on the disc contents.
- Depending on the condition of the unit (playing, stopped, etc.) and the type of software you are playing, there are some items that you cannot select or change.

### ▶ Disc menu-Setting disc content

RAM -R -R DL -RW(V) +R +R DL +RW DVD-A DVD-V -RW(VR)  
VCD

#### Soundtrack

RAM -R -R DL -RW(V) +R +R DL +RW -RW(VR)

The disc's audio attributes appear.

DVD-A DVD-V

Select the audio and language. (See [B] Audio attributes)

#### Subtitle

DVD-A DVD-V

Turn the subtitle on/off and select the language (See [A] Sound track/Subtitle language)

RAM -R -R DL -RW(V) +R +R DL +RW -RW(VR)

(Only disc that contain subtitle on/off information)

Turn the subtitle on/off.

- Subtitle on/off information cannot be recorded using this unit.

- If the subtitles overlap the closed captions recorded on discs, turn the subtitles off.

#### Audio channel RAM -RW(VR) VCD

"Changing audio during play" (→ 33)

#### Angle DVD-A DVD-V

Change the number to select an angle.

#### Still-P (Still picture) DVD-A

Selects the play method for still pictures.

**Slide Show:** Plays according to the default order on the disc.

**Page:** Select the still picture number and play.

**RANDOM:** Plays in random order.

**Return:** Returns to the default still picture on the disc.

#### PBC (Playback control) VCD (→ 76)

Indicates whether menu play (playback control) is on or off.

#### [A] Sound track/Subtitle language

|                |                 |                |
|----------------|-----------------|----------------|
| ENG: English   | DAN: Danish     | THA: Thai      |
| FRA: French    | POR: Portuguese | POL: Polish    |
| DEU: German    | RUS: Russian    | CES: Czech     |
| ITA: Italian   | JPN: Japanese   | SLK: Slovak    |
| ESP: Spanish   | CHI: Chinese    | HUN: Hungarian |
| NLD: Dutch     | KOR: Korean     | FIN: Finnish   |
| SVE: Swedish   | MAL: Malay      | *: Others      |
| NOR: Norwegian | VIE: Vietnamese |                |

#### [B] Audio attributes

LPCM/PPCM/DD Digital/DTS/MPEG: Signal type

k (kHz): Sampling frequency

b (bit): Number of bits

ch (channel): Number of channels

#### For your reference

- The display changes according to the disc content. You cannot make a change when there is no recording.
- Some discs allow changes to sound tracks, subtitles, and angles only by using the disc's setup menus.

### ▶ Play menu-Change play sequence

RAM -R -R DL -RW(V) +R +R DL +RW DVD-A DVD-V -RW(VR)  
VCD CD

#### Repeat play

This function works only when the elapsed play time is displayed.

Select the item for repeat play. Depending on the disc, the items that can be selected will differ.

- All VCD CD (excluding MP3 discs)
  - Chapter RAM -R -R DL -RW(V) +R +R DL +RW DVD-V -RW(VR)
  - Group DVD-A CD (MP3 discs only)
  - Playlists RAM -RW(VR)
  - Title RAM -R -R DL -RW(V) +R +R DL +RW DVD-V -RW(VR)
  - Track DVD-A VCD CD
- Select "Off" to cancel.

▶ **Video menu-Change picture quality**

RAM -R -R DL -RW(V) +R +R DL +RW DVD-A DVD-V -RW(VR)  
VCD

**Picture**

To select the picture mode during play

**Normal:** Default setting

**Soft:** Soft picture with fewer video artifacts

**Fine:** Details are sharper

**Cinema:** Mellows movies, enhances detail in dark scenes.

**DNR**

Reduces noise and picture degradation.

On ↔ Off

\* **Progressive** (→ 76)

Select "On" to enable progressive output.

• Select "Off" if the picture is stretched horizontally.

• When progressive output is on, closed captions cannot be displayed.

On ↔ Off

\* **Transfer** (When "Progressive" is set to "On")

Select the method of conversion for progressive output to suit the type of material being played (→ 76, "Film and Video").

**Auto1 (normal):**

Detects 24 frame-per-second film content and appropriately converts it.

**Auto2:** Compatible with 30 frame-per-second film content in addition to 24 frame-per-second film content.

**Video:** Select when the video content is distorted by using Auto1 and Auto2.

**Line-in NR** (Only when IN1, IN2 or DV is selected)

Reduces video tape noise during transfer (copy).

Depending on the software, jittering may occur.

**Automatic:**

Noise reduction only works on picture input from a video tape.

**On:** Noise reduction works for any video input.

**Off:** Noise reduction is off. Select when you want to record input as is.

\* Only when you have selected "480p" in "TV Type" (→ 20).

▶ **Audio menu-Change sound effect**

RAM -R -R DL -RW(V) +R +R DL +RW DVD-A DVD-V -RW(VR)

**V. Surround Sound**

RAM -R -R DL -RW(V) +R +R DL +RW DVD-A DVD-V -RW(VR)

(Only for Dolby Digital with 2.0 or more channels)

Enjoy a surround-sound effect if you are using 2 front speakers (L/R) only.

Natural ↔ Emphasis ↔ Off

↑ ↓

**Notes**

• Turn V. Surround Sound off if it causes distortion.

• V. Surround Sound does not work for SAP recordings.

**Dialog Enhancer**

RAM -R -R DL -RW(V) +R +R DL +RW DVD-A DVD-V -RW(VR)

(Dolby Digital, 3-channel or over only, including a center channel)

The volume of the center channel is raised to make dialog easier to hear.

On ↔ Off

▶ **Other menu-Change the display position**

**Position**

To change the display position

**1 (Standard) –5:**

The higher the setting the lower the screen moves.

**FUNCTIONS window**

By using the FUNCTIONS window you can access the main functions quickly and easily.

**1 While stopped**

**Press [FUNCTIONS].**

• Functions displayed depend on the type of disc.

**2 Select an item with**

**[▲, ▼] and press**

**[ENTER].**

• If you select "Other Functions", press [▲, ▼] to select

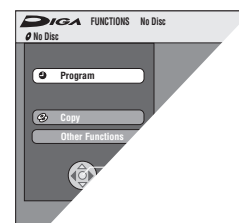

■ **To exit the FUNCTIONS v**

Press [FUNCTIONS].

**Status mes**

Status messages appear on the screen to inform you what operation was performed and what condition the unit is in.

**Press [STATUS] to change the information displayed.**

The display changes each time you press the button.

For example,

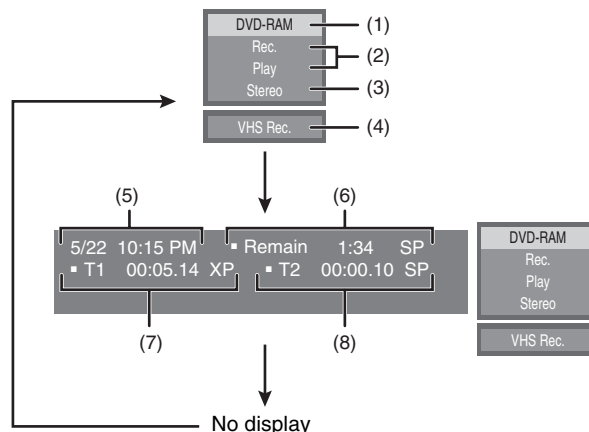

■ **Display examples**

- (1) **Current medium**
- (2) **Current recording or play status, input channel**
  - Shows the current state of the unit and the input channel.
- (3) **Audio type** (→ 27, 33)
- (4) **Other drive mode**
- (5) **The current date and time**
- (6) **Available recording time and recording mode**
  - (e.g.: "1:34 SP" indicates 1 hour and 34 minutes in SP mode)
  - Disc remaining time may slightly differ between different models.
- (7) **Elapsed play time**
- (8) **Recording time**
  - Shows recording time, recording mode and a rough guide to how much space has been used for recording on the disc.



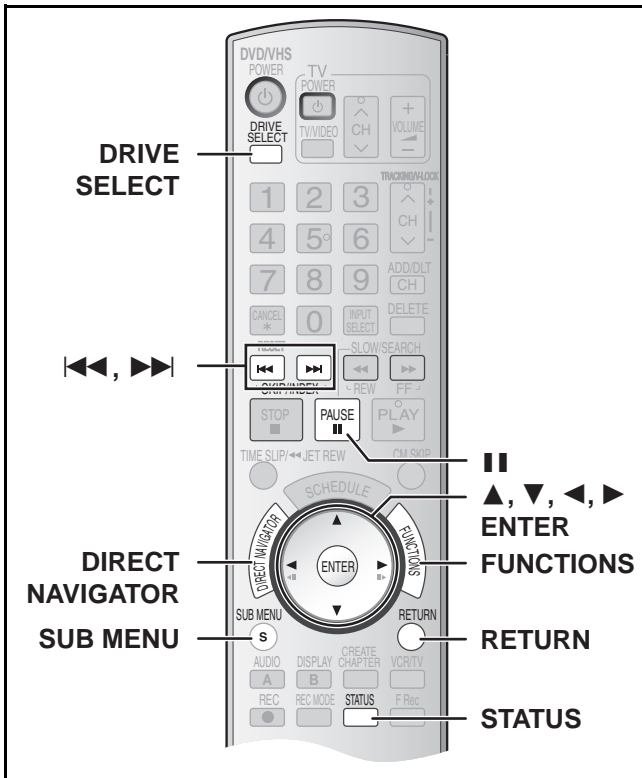

**RAM -R -R DL -RW(V) +R +R DL +RW -RW(VR)**

Press [DIRECT NAVIGATOR] and the list of titles recorded (Title View) is shown. You can play and edit a desired title.

### For your reference

- You cannot edit during recording or transferring (copying), etc.
- You can create a Top Menu using "Create DVD Top Menu" (→ 62). Recording or editing on the disc may delete the menu. In that case, create the menu again. **+RW**
- Management information is recorded in unused sections when you edit discs. The available space these discs decreases each time you edit their contents. **+R +R DL**
- The maximum number of items on a disc:
  - Title: 99 (**+R +R DL +RW**) 49 titles)
  - Chapter: Approximately 1000 (**+R +R DL +RW**) Approximately 254) (Depends on the state of recording.)

**Title/Chapter**  
 Programs are recorded as a single title consisting of one chapter.

Title

Chapter

Start End

↓

You can divide a title into multiple chapters. **RAM** (→ 33, "Create chapters", → 43 "Create Chapter")

Title

Chapter

Chapter

Chapter

Chapter

↓

- You can change the order of chapters and create a playlist (→ 44). **RAM**
- Titles are divided into chapters about 5 minutes after finalizing (→ 61). **-R -R DL -RW(V)** (8 minutes **+R +R DL**)

### Various operations

- To show other pages**  
 Press [▲, ▼, ◀, ▶] to select "Previous" or "Next" and press [ENTER].  
 • You can also press [◀◀, SKIP] or [▶▶, SKIP] to show other pages.
- Multiple editing**  
 Select with [▲, ▼, ◀, ▶] and press [⏸, PAUSE]. (Repeat)  
 A check mark appears. Press [⏸, PAUSE] again to cancel.

## Editing titles/Chapters and playing chapters

### Note

- Once deleted, divided or shortened, the title cannot be restored to its original state. Make certain before proceeding.

### Preparation

- Release protection (disc → 60, cartridge → 60). **RAM**
- Press [DRIVE SELECT] to select the DVD drive.

**1 Press [DIRECT NAVIGATOR].**

e.g.; **RAM**

**2 Use [▲, ▼, ◀, ▶] to select a desired title.**

- "To show other pages" (→ below)

**3 Press [SUB MENU].**

**4 Use [▲, ▼] to select a desired item and press [ENTER].**

- After this operation, follow the desired operation.

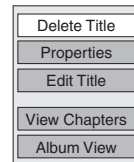

### To stop in the middle

Press [RETURN].

### For your reference

- When the title is protected (→ 42), some items are not accessible. Release the protection to access the inaccessible items. **RAM**

## Title operations

### Delete Title

**RAM -R -R DL -RW(V) +R +R DL +RW**

(Multiple editing is possible. → below)

- Follow steps 1 to 3 of "Editing titles/Chapters and playing chapters".

e.g.; **RAM**

Once title is deleted using this procedure, it cannot be retrieved. Check the title carefully before erasing to ensure it isn't the one you want to keep.

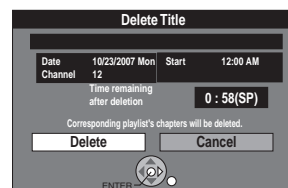

**4 Select "Delete Title" with [▲, ▼] and press [ENTER].**

**5 Select "Delete" with [◀] and press [ENTER].**

### For your reference

- The disc's available recording time may not increase after erasing short titles.
- The available recording space on DVD-R, DVD-R DL, +R or +R DL does not increase when you delete titles.
- The available recording space on a DVD-RW (DVD-Video format) or +RW increases when the last recorded title is deleted. (The recording space may increase slightly when other titles are deleted.)

### Properties

**RAM -R -R DL -RW(V) +R +R DL +RW -RW(VR)**

- Follow steps 1 to 3 of "Editing titles/Chapters and playing chapters".

Title information (e.g., date and time) is shown.

**4 Select "Properties" with [▲, ▼] and press [ENTER].**



### Album View

**RAM**

- Follow steps 1 to 3 of "Editing titles/Chapters and playing chapters".

**4 Select "Album View" with [▲, ▼] and press [ENTER].**

- Album View screen is displayed.  
 ["Playing still pictures (JPEG/TIFF)" → 35]

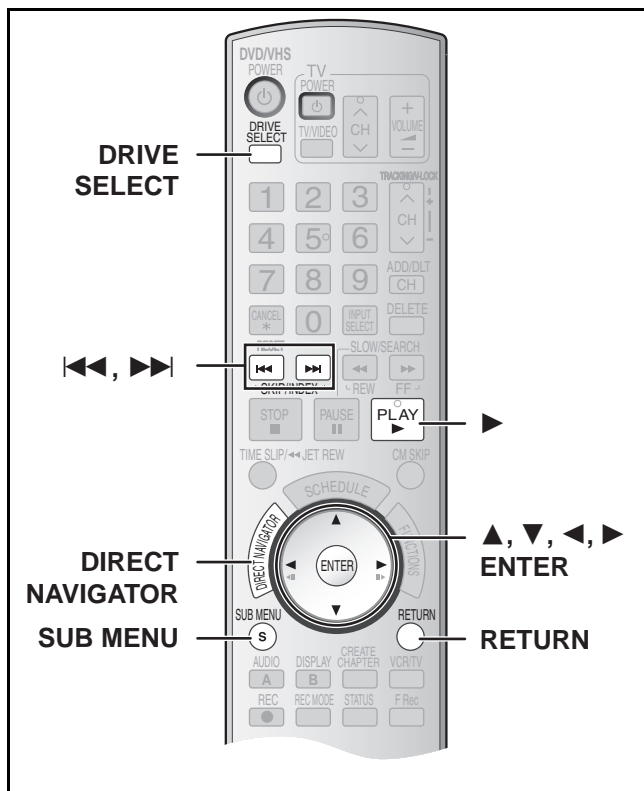

**Edit Title**

You can perform various kinds of title editing.

**Preparation**

- Release protection (disc → 60, cartridge → 60). **RAM**
- Select DVD side with pressing [DRIVE SELECT].

**1** Press [DIRECT NAVIGATOR] and use [▲, ▼, ◀, ▶] to select a desired title.

- “To show other pages” → 41
- “Multiple editing” → 41

**2** Press [SUB MENU].

**3** Select “Edit Title” with [▲, ▼] and press [ENTER].

**4** Use [▲, ▼] to select a desired item and press [ENTER].

- The editing screen for the selected item appears.

e.g.; **RAM**



**To return to the previous screen**

Press [RETURN].

**To exit the screen**

Press [RETURN].

**Title Name**

**RAM -R -R DL -RW(V) +R +R DL +RW**

- Follow steps 1 to 3 of “Edit Title”.

**4** Select “Title Name” with [▲, ▼] and press [ENTER].

- Refer to “Entering text”. (→ 58)

**Set Protection/Cancel Protection**

**RAM +R +R DL +RW** (“Multiple editing” → 41)

- Follow steps 1 to 3 of “Edit Title”.

You can prevent accidental erasure of titles by setting and canceling the write-protection.

**4** Select “Set Protection” or “Cancel Protection” with [▲, ▼] and press [ENTER].

**5** Select “Yes” with [◀] and press [ENTER].

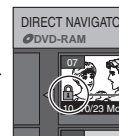

Set up Protection:  
The padlock mark appears.

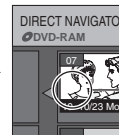
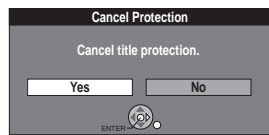

Cancel Protection:  
The padlock mark disappears.

**For your reference**

Titles will be erased even if they are protected if you format the disc with DVD Management (→ 60).

**Shorten Title**

**RAM**

- Follow steps 1 to 3 of “Edit Title”.

You can remove unnecessary parts of the title such as commercials.

**4** Select “Shorten Title” with [▲, ▼] and press [ENTER].



**5** Press [ENTER] at the start point and end point of the section you want to erase. (→ 43, “For quicker editing”)

**6** Select “Exit” with [▲, ▼] and press [ENTER].

**7** Select “Delete” with [◀] and press [ENTER].

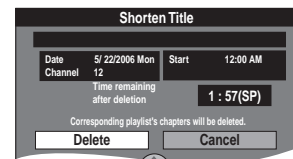

**To erase another part of the same title**

After setting the point in “Start” and “End”, select “Next” in step 5 and perform step 7, then repeat steps 5 to 7.

**For your reference**

- You may not be able to specify start and end points within 3 seconds of each other.
- The disc’s available recording time may not increase after erasing short parts of titles.

**Change Thumbnail**

**RAM -R -R DL -RW(V) +R +R DL +RW**

- Follow steps 1 to 3 of “Edit Title”.

You can change the image to be shown as a thumbnail picture in the Title View.

**4** Select “Change Thumbnail” with [▲, ▼] and press [ENTER].

**5** Press [▶, PLAY] to play.

**6** Press [ENTER] at the point you want to display. (→ 43, “For quicker editing”)

- To change to another point in the same title:

- Select “Change” with [▲, ▼] and press [▶, PLAY] and then repeat step 6.

**7** Select “Exit” with [▲, ▼] and press [ENTER].

- The thumbnail picture will be changed at this point.





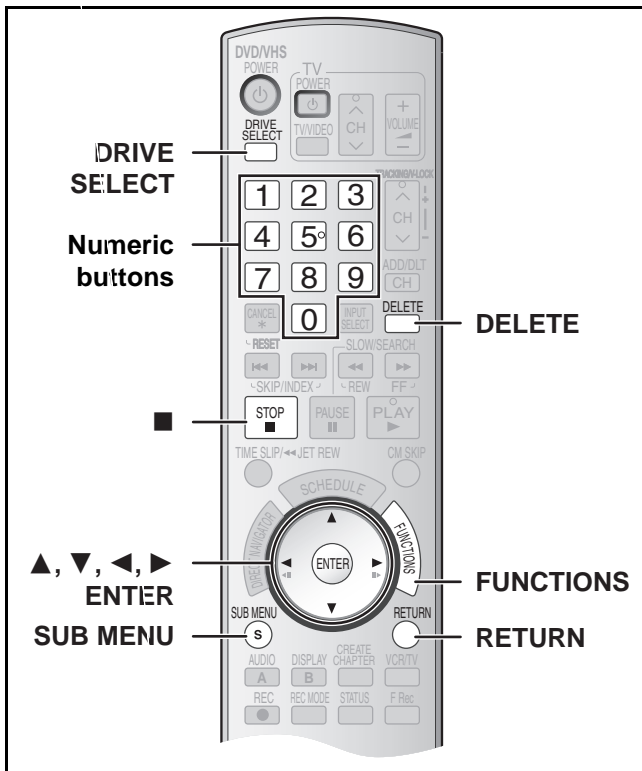

**3** Select “Playlists” with [▲, ▼] and press [ENTER].

- The Playlist View appears.

**4** Select “Create” with [▲, ▼, ◀, ▶] and press [ENTER].

**5** Use [◀, ▶] to select the source title and press [▼].

- When you want to select all chapters in the title, use [◀, ▶] to select the source title and press [ENTER], then skip to step 7.
- Repeat steps 5 to 7 to add other titles or chapters.

**6** Use [◀, ▶] to select the chapter you want to add to a playlist and press [ENTER].

- Press [▲] to cancel.

• You can also create a new chapter in the source title. Press [SUB MENU] to select “Create Chapter” and press [ENTER] (→ 43, “Create Chapter”).

**7** Use [◀, ▶] to select the position to insert the chapter and press [ENTER].

- The chapter is registered in the playlist.
- Repeat steps 6 to 7 to add other chapters.
- To select other source titles, press [▲] several times to return to step 5.

**8** Press [RETURN].

■ **To return to the previous screen**

Press [RETURN].

■ **To exit the screen**

Press [RETURN].

## RAM

You can create a playlist by gathering your favorite chapters (→ 41) from your recordings. You can also play and edit the created playlist.

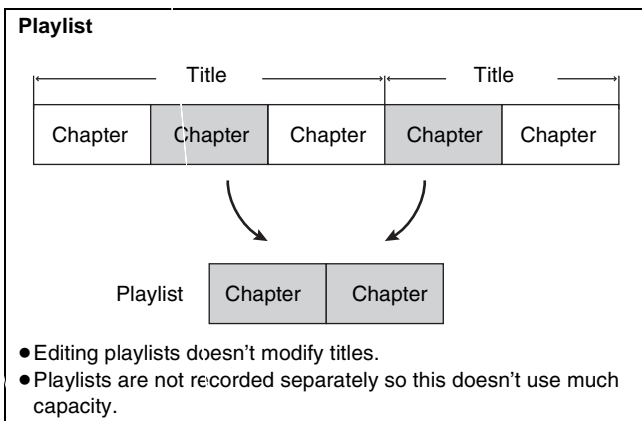

- The maximum number of items on a disc:
  - Playlists: 99
  - Chapters in play lists: Approximately 1000 (Depends on the state of recording.)
- If you exceed the maximum numbers of items for a disc, all the items entered will not be recorded.
- You cannot create or edit a playlist while recording.

## Creating playlists

### RAM

#### Preparation

- Release protection. (disc → 60, cartridge → 60)
- Press [DRIVE SELECT] to select the DVD drive.

**1** While stopped Press [FUNCTIONS].

**2** Select “Other Functions” with [▲, ▼] and press [ENTER].

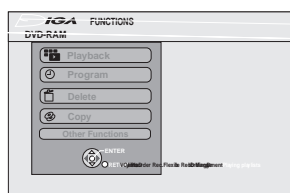

### RAM -RW(VR) (Play only)

#### Preparation

- Create playlists.
- Select DVD side with pressing [DRIVE SELECT].

**1** While stopped Press [FUNCTIONS].

**2** Select “Other Functions” with [▲, ▼] and press [ENTER].

**3** Select “Playlists” with [▲, ▼] and press [ENTER].

- 4 Use [▲, ▼, ◀, ▶] to select a playlist and press [ENTER].**
- Chapters are not displayed if you have not yet created a playlist with the disc.
  - You can also select a playlist from the Playlist View by entering a 2-digit number with the numeric buttons.  
e.g.: "5": [0]→[5]  
"15": [1]→[5]
  - If you enter a number larger than the total number of playlists, "Create" is selected.
  - "To show other pages" → 41

- To stop playlist play**  
Press [■, STOP]. (The Playlist View screen appears.)
- To return to the previous screen**  
Press [RETURN].
- To exit the screen**  
Press [RETURN].
- To delete a playlist during play**
- 1 Press [DELETE].
    - A confirmation message will be displayed.
  - 2 Use [◀] to select "Delete" and press [ENTER].
- For your reference**
- You can use fast-forward, fast-rewind, pause, and slow-motion while playing chapters just as you can during normal play.

## Editing playlists/chapters

- RAM -RW(VR)** (Properties only)
- Preparation**
- Create playlists. (→ 44)
  - Release protection (disc → 60, cartridge → 60). **RAM**
  - Select DVD side with pressing [DRIVE SELECT].
- 1 While stopped  
Press [FUNCTIONS].
  - 2 Select "Other Functions" with [▲, ▼] and press [ENTER].
  - 3 Select "Playlists" with [▲, ▼] and press [ENTER].
    - Chapters are not displayed if you have not yet created a playlist on the disc.
  - 4 Use [▲, ▼, ◀, ▶] to select a playlist. e.g.: **RAM**  
• "To show other pages" → 41
  - 5 Press [SUB MENU].
  - 6 Use [▲, ▼] to select a desired item and press [ENTER].

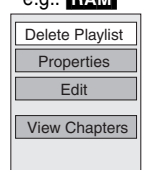

- To return to the previous screen**  
Press [RETURN].
- To exit the screen**  
Press [RETURN].

## Playlist operations

### ■ Delete Playlist

- RAM** ("Multiple editing" → 41)
- Follow steps 1 to 5 of "Editing playlists/chapters".
- 6 Select "Delete Playlist" with [▲, ▼] and press [ENTER].
  - 7 Select "Delete" with [◀] and press [ENTER].
    - The playlist is deleted.
    - Once a playlist has been deleted, it cannot be restored. Check carefully before proceeding.
    - Even if you delete the playlist, the original title is not deleted.

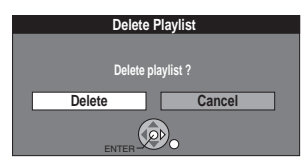

### ■ Properties

- RAM -RW(VR)**
- Follow steps 1 to 5 of "Editing playlists/chapters".
- 6 Select "Properties" with [▲, ▼] and press [ENTER].**
- Playlist information (e.g., date and length) is shown.



### ■ Edit

- RAM**
- You can perform various kinds of playlist editing.
- 1 While stopped  
Press [FUNCTIONS].
  - 2 Select "Other Functions" with [▲, ▼] and press [ENTER].
  - 3 Select "Playlists" with [▲, ▼] and press [ENTER].
  - 4 Use [▲, ▼, ◀, ▶] to select a playlist.  
• "To show other pages" → 41
  - 5 Press [SUB MENU], then select "Edit" with [▲, ▼] and press [ENTER].  
e.g.: **RAM**
  - 6 Use [▲, ▼] to select a desired item and press [ENTER].

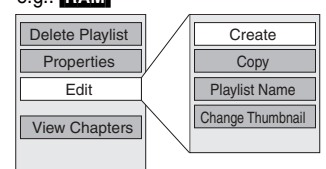

- To return to the previous screen**  
Press [RETURN].
- To exit the screen**  
Press [RETURN].

### ▶ Create

- Follow steps 1 to 5 of "Edit".
- 6 Select "Create" with [▲, ▼] and press [ENTER].**  
Refer to "Creating playlists", steps 5–8. (→ 44)

### ▶ Copy

- ("Multiple editing" → 41)
- Follow steps 1 to 5 of "Edit".
- 6 Select "Copy" with [▲, ▼] and press [ENTER].
  - 7 Select "Copy" with [◀] and press [ENTER].



### ▶ Playlist Name

- Follow steps 1 to 5 of "Edit".
- 6 Select "Playlist Name" with [▲, ▼] and press [ENTER].**  
Refer to "Entering text". (→ 58)

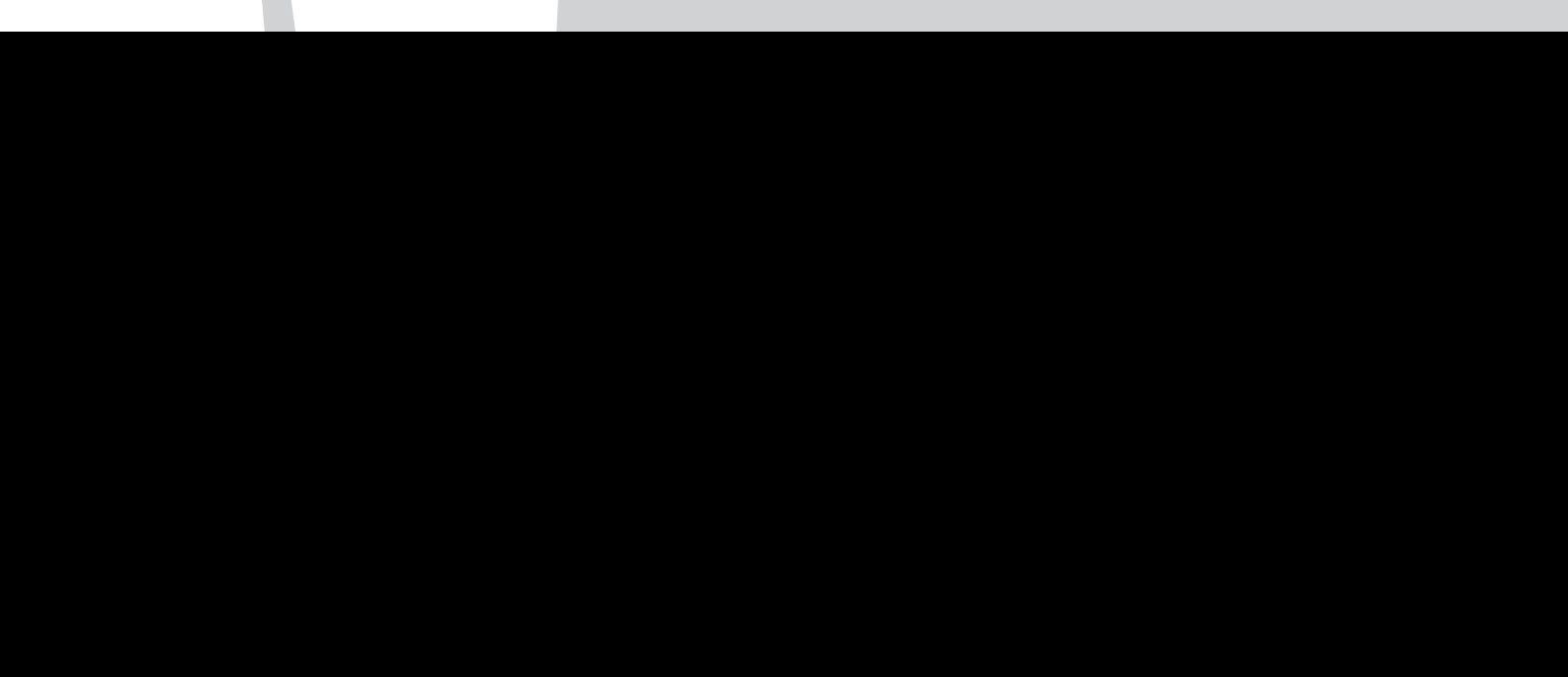



**SD** (Multiple editing is possible. → 47)

- Follow steps 1 to 4 of “Editing still pictures”.

You can select a whole folder or individual pictures for printing and specify the number of prints to be made.

**5** Select “Print Order (DPOF)” with [**▲**, **▼**] and press [**ENTER**].

**6** Press [**◀**, **▶**] to select number of print (0 to 9) and press [**ENTER**].

- The DPOF mark appears.  
(This appears on the still pictures inside a folder when you make the DPOF setting for the folder.)

---

### ■ To cancel the print setting

Set the number of prints to “0”.

#### For your reference

- Print settings (DPOF) made using this unit may not be viewable on other equipment.
- When this is set by this unit, any settings established by other units will be released.
- Settings cannot be made for folders and files not in accordance with DCFes 6( )-15no ranchess on tsa.



## Before transferring (copying)

You can select from a variety of methods to transfer (copy) on the unit.  
 You cannot transfer (copy) titles which have been treated to prevent copying.

| Direction  |   | Type of transfer (copying) you want   | Suitable methods          |
|--|---|---|---------------------------|
| From   | To  |   |                           |
| VHS  | DVD-RAM, DVD-R, DVD-R DL, DVD-RW (DVD-Video format), +R, +R DL or +RW | <b>Easy transferring (copying) with one button</b><br>● When you want to transfer (copy) from the selected start point to the end of the tape   | One Touch Transfer (→ 50) |
|  |   | <b>Transferring (copying) with detailed settings</b><br>● When you want to transfer (copy) from the selected start point to the end of the tape<br>● When you want to transfer (copy) for the limited amount of time<br>● When you want to transfer (copy) to fit in the remaining capacity of the disc | GUI Transfer (→ 51)       |
| DVD-RAM, +RW or DVD-RW (DVD Video Recording format)  | VHS   | <b>Easy transferring (copying) with one button</b><br>● When you want to transfer (copy) a whole disc<br>● When you want to transfer (copy) from the beginning of the selected title and playlist to the end of the disc*   | One Touch Transfer (→ 52) |
|  |   | <b>Transferring (copying) with detailed settings</b><br>● When you want to transfer (copy) multiple titles or playlists in combination*   | GUI Transfer (→ 53)       |
| DVD-R, DVD-R DL, DVD-RW (DVD-Video format), +R or +R DL  | VHS   | <b>Easy transferring (copying) with one button</b><br>● When you want to transfer (copy) a whole disc<br>● When you want to transfer (copy) from the beginning of the selected title to the end of the disc   | One Touch Transfer (→ 52) |
|  |   | <b>Transferring (copying) with detailed settings</b>  | Cannot transfer           |
| Finalized DVD-R, DVD-R DL, DVD-RW (DVD-Video format), +R, +R DL or DVD-Video on sale that are not copy-protected, etc. | VHS   | <b>Easy transferring (copying) with one button</b>  | Cannot transfer           |
|  |   | <b>Transferring (copying) with detailed settings</b><br>● When you want to transfer (copy) whole of a disc<br>● When you want to transfer only for the specified time   | DVD-Video Transfer (→ 54) |

\* Since you cannot create playlists on +RW, you cannot copy those. **+RW**

### ■ Caution for transfer (copying) from VHS to DVD

- Copy-protected video tapes cannot be copied. Most video tapes are copy-protected to prevent illegal copying so they cannot be copied.
- When a copy-protected tape is inserted, a message appears on the display and the recording stops on the spot.
- If a part of a tape recorded in VP mode is copied to disc, noise may appear at the beginning of the copied part.

#### Only the following operations are allowed while transferring (copying):

- Stopping transfer (One Touch or GUI Transfer) by pressing and holding [RETURN] for about 3 seconds or more.
- Stopping transfer (One Touch Transfer) by pressing [■, STOP].

#### When transfer (copying) is started, the following operations also start automatically

- "Status Messages" on Display → "Off" (→ 65) (One Touch or GUI Transfer)

### ■ Caution for transfer (copying) from DVD to VHS

- Copy-protected discs cannot be copied. Most discs are copy-protected to prevent illegal copying so they cannot be copied.

#### Only the following operations are allowed while transferring (copying):

- Stopping transfer (One Touch or GUI Transfer) by pressing and holding [RETURN] for about 3 seconds or more.
- Stopping transfer (One Touch Transfer) by pressing [■, STOP].

#### When transfer (copying) is started, the following operations also start automatically

- "Status Messages" on Display → "Off" (→ 65) (One Touch or GUI Transfer)
- Audio output when playing back DVD → Stereo (L R) **RAM** (One Touch or GUI Transfer)

When the playback location of the disc is recorded by the Resume Function (→ 32) and you start transferring (copying), the transfer (copying) is executed from the top of the title which contains the starting position of playback to the end of the disc.

### ■ Copying still pictures **RAM SD**

- When you want to copy all still pictures on a SD card. (→ 55)
- When you want to copy multiple still pictures in combination. (→ 55)

## Transfer (Copying) from VHS

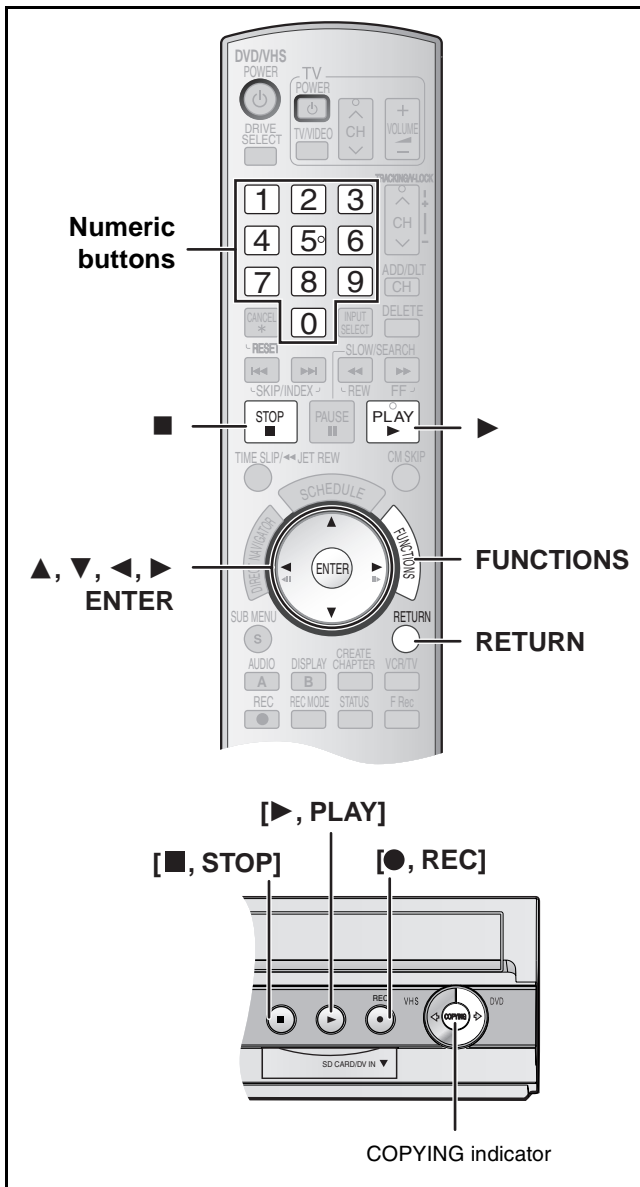

### ■ One Touch Transfer (Copying) (VHS → DVD)

**RAM -R -R DL -RW(V) +R +R DL +RW**

You can transfer (copy) programs recorded on a tape onto a disc\* with one stroke of the button.

In One Touch Transfer (Copying), programs are automatically transferred (copied) onto the disc from the location of playback at the time when the transfer (copying) of the tape starts.

\* Available discs for transfer (copying) from tape are DVD-RAM, non-finalized DVD-R, DVD-R DL, DVD-RW (DVD-Video format), +R, +R DL, and +RW.

#### Preparation

● Select the unit viewing channel (e.g. AV input) on the TV.

#### DVD

- Release protection (disc → 60, cartridge → 60). **RAM**
- Insert a disc and confirm there is sufficient empty space for recording (→ 24, 40).
- Select the recording mode. (→ 26)
- When SAP broadcast program is played back on VHS, select the audio to be recorded on disc in "Multi-channel TV sound (MTS)" in the "Setup" menu. (→ 64) **-R -R DL -RW(V) +R +R DL +RW**

#### VHS

- Insert the video cassette containing the program to be copied (→ 11, 24).

- 1 While both DVD and VHS are stopped  
Press and hold [▶ DVD] on the main unit for about 3 seconds or more (until "START" on the unit's display terminates flashing).

e.g.: **RAM**



**-R -R DL -RW(V) +R +R DL**

And then press [● REC] or [▶ PLAY] on the main unit to copy the disc with or without finalizing.

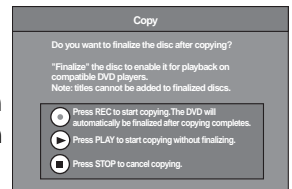

- If you press [● REC] on the main unit, the disc will automatically be finalized after copying completes.
- If you press [▶ PLAY] on the main unit, you can start copying without finalizing.
- If you press [■ STOP] on the main unit, you can cancel to copy.

- Check if transfer (copying) starts properly.
- Copying is automatically completed when the tape reaches its end or the disc becomes full.
- If you press [● REC] on the main unit to finalize; After finalizing, the discs become play-only and you can also play them on other DVD equipment. However, you can no longer record or edit.
- In case the copying doesn't complete due to shortage of remaining time of disc or etc., the finalizing doesn't start.

### ■ To stop transfer (copying) in the middle

Press [■ STOP] or press and hold [RETURN] for about 3 seconds or more.

- However, you cannot stop finalizing after it has started.

#### Notes

- While One Touch Transfer (Copying) is activated, a scheduled recording cannot be started.
- When the transfer (copying) is not started or not executed, the "COPYING" indicator blinks for about 7 seconds. Check if the unit is properly prepared.

### ■ Dividing a title to be copied

In One Touch Transfer (Copying) from VHS to DVD, the title is divided by index signal detected and then recorded. You can search desired titles with Direct Navigator's Title View (→ 41) after transfer (copy) to DVD.

- Titles recorded within 15 minutes (25 minutes in VP mode) of each other may not be divided properly.
- The recording time may become longer than the original title depending on the number of index signals.

**If you want to transfer (copy) without dividing the contents into titles, follow the methods below.**

- Set "Time Limit" to "On" on the GUI transfer (→ 51).

## ■ GUI (Graphical User Interface) Transfer (Copying)

**RAM -R -R DL -RW(V) +R +R DL +RW**

You can transfer (copy) programs recorded on a tape onto a disc\*\* from the location\* of playback as of the transfer (copying) start of the tape.

\* When you set the recording mode to "FR" and "Time Limit" to "Off", you can transfer (copy) the whole tape from the beginning to the end. (→ below)

\*\* Available discs for transfer (copying) from tape are DVD-RAM, non-finalized DVD-R, DVD-R DL, DVD-RW (DVD-Video format), +R, +R DL, and +RW.

### Preparation

● Select the unit viewing channel (e.g. AV input) on the TV.

### DVD

- Release protection (disc → 60, cartridge → 60). **RAM**
- Insert a disc and confirm there is sufficient empty space for recording on it (→ 24, 40).
- When SAP broadcast program is played back on VHS, select the audio to be recorded on discs in "Multi-channel TV sound (MTS)" in the "Setup" menu. (→ 64) **-R -R DL -RW(V) +R +R DL +RW**

### VHS

● Insert the video cassette containing the program to be copied (→ 11, 24).

### 1 While both DVD and VHS are stopped

Press [FUNCTIONS].

### 2 Select "Copy" with [▲, ▼] and press [ENTER].

### 3 Set the transfer (copying) direction.

- Set "Source" to "VHS".
- If you are not going to change the copy direction, press [▼], then skip to step 4.

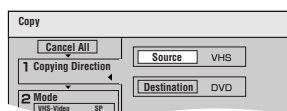

### ■ To change the setting

- (1) Make sure "Copying Direction" is selected and press [▶].
- (2) Make sure "Source" is selected and press [ENTER].
- (3) Press [▲, ▼] to select "VHS" and press [ENTER].
  - When you set "Source" to "VHS", "DVD" is automatically selected on "Destination".
- (4) Press [◀].
- (5) Press [▼].

### 4 Set the recording mode.

- If you are not going to change the recording mode, press [▼], then skip to step 5.

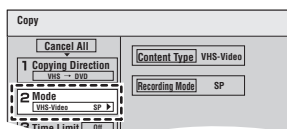

### ■ To change the setting

- (1) Make sure "Mode" is selected and press [▶].
- (2) Make sure "Recording Mode" is selected and press [ENTER].
- (3) Select recording mode (XP, SP, LP, EP or FR) with [▲, ▼] and press [ENTER].
  - "About FR mode" (→ right)
- (4) Press [◀].
- (5) Press [▼].

### 5 Set the time limit.

- If you are not going to change the recording time, press [▼], then skip to step 6.

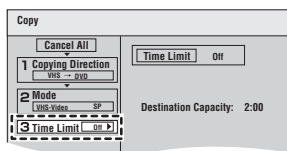

### ■ To change the setting

- (1) Make sure "Time Limit" is selected and press [▶].
- (2) Make sure "Time Limit" is selected and press [ENTER].
- (3) Select time limit ("On" or "Off") with [▲, ▼] and press [ENTER].
  - When you select "Off", proceed to Step (6) below.
- (4) Press [▲, ▼] to select "Set time" and press [ENTER].
- (5) Press [◀, ▶] to select "Hour" and "Min." and press [▲, ▼] to set the recording time, and then press [ENTER].
  - You can also set the set time with the numeric buttons.
  - Maximum recording time is 8 hours.
- (6) Press [◀].
- (7) Press [▼].

### 6 Make sure "Start Copying" is selected and press [ENTER].

- The confirmation screen appears.

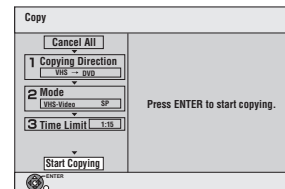

### 7 Select "Yes" with [◀] and press [ENTER].

**-R -R DL -RW(V) +R +R DL**  
**And then press [◀, ▶] to select "Copy and finalize" or "Copy only" and press [ENTER].**

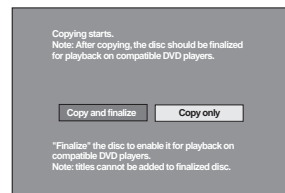

- Transfer (copying) is started.
- Transfer (copying) is automatically stopped when the tape reaches the end or the remaining capacity of the disc is filled. (A message appears on the TV screen and then disappears a few seconds later.)

### ● If "Copy and finalize" is selected;

**After finalizing, the discs become play-only and you can also play them on other DVD equipment.**

**However, you can no longer record or edit.**

- In case the copying doesn't complete due to shortage of remaining time of disc or etc., the finalizing doesn't start.

### ■ To stop transfer (copying) in the middle

Press and hold [RETURN] for about 3 seconds or more.

- However, you cannot stop finalizing after it has started.

### ■ About FR Mode

**When "Time Limit" is set to "Off" in Step 5 above:**

- The recording mode is automatically selected by estimating the remaining capacity of the disc for transfer (copying) of only the recorded parts in the video cassette (unrecorded parts will not be recorded).
- When you press [ENTER] to start transfer (copy), the tape is automatically fast-forwarded to the end and then fast-rewound to the beginning before the transfer (copying) is actually started. It may take time to start transfer (copy). If the remaining capacity of the disc is insufficient, the transfer (copying) will be stopped in the middle.
- The recording is divided into titles every time the tape index signals are detected.

**When "Time Limit" is set to "On" in Step 5 above:**

- The recording mode is automatically determined by estimating the remaining capacity of the disc for transfer (copying) of the contents equivalent to the recording time set from the start point of the transfer (copying) on the video cassette (unrecorded parts will also be recorded).
- The recording is not divided into titles.

Transfer (Copying) from DVD

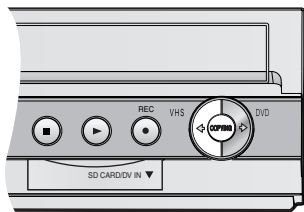
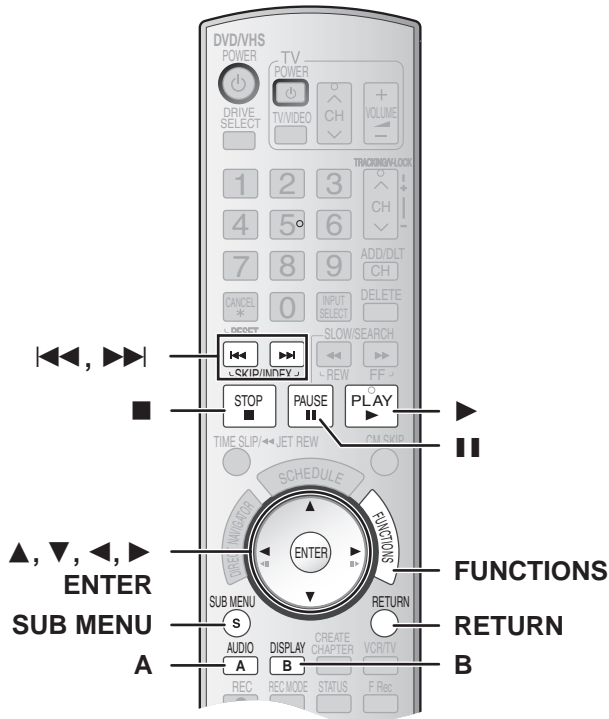

You can transfer (copy) titles recorded on a disc\* onto a tape with one touch of the button.

In One Touch Transfer (copying), all contents on the disc are automatically copied onto the tape.

\* Available discs for transfer (copying) onto tape are

**RAM -R -R DL -RW(V) +R +R DL +RW -RW(VR).**

**Preparation**

- Select the unit viewing channel (e.g. AV input) on the TV.

**DVD**

- Insert the disc containing the program to be copied (→ 24).

**VHS**

- Insert a video cassette with an accidental erasure prevention tab. (→ 11, 24)
- Confirm that the remaining tape time is sufficient for recording. (→ 40)
- Select the recording mode. (→ 26)

- 1 Press and hold [VHS ↵] on the main unit for about 3 seconds or more (until “START” on the unit’s display terminates flashing).**

- Check if transfer (copying) starts properly.
- Copying is automatically completed when playback of the disc is finished or the tape reaches its end.

**■ To stop transfer (copying) in the middle**

Press [■, STOP] or press and hold [RETURN] for about 3 seconds or more.

**Notes**

- While One Touch Transfer (Copying) is activated, a scheduled recording cannot be started.
- When the transfer (copying) is not started or not executed, the “COPYING” indicator blinks for about 7 seconds. Check to make sure the unit is properly prepared.
- If you start transfer (copying) when resume function is activated, the DVD is copied from the beginning of the title which you stopped.

## ■ GUI (Graphical User Interface) Transfer (Copying)

### RAM +RW -RW(VR)

You can transfer (copy) multiple titles or playlists recorded on a disc onto a tape in combination.

- Available discs for transfer (copy) onto tape are **RAM -RW(VR)**.
- Since you cannot create playlists on +RW, you cannot copy those.

### +RW

#### Preparation

- Select the unit viewing channel (e.g. AV input) on the TV.

#### DVD

- Insert the disc containing the program to be copied (→ 24).

#### VHS

- Insert a video cassette with an accidental erasure prevention tab. (→ 11, 24)
- Confirm that the remaining tape time is sufficient for recording. (→ 40)

### 1 While both DVD and VHS are stopped

Press [FUNCTIONS].

### 2 Select "Copy" with [▲, ▼] and press [ENTER].

### 3 Set "Copying Direction".

- Set "Source" to "DVD".
- If you are not going to change the copy direction, press [▼], then skip to step 4.

#### ■ To change the setting

- (1) Make sure "Copying Direction" is selected and press [▶].
- (2) Make sure "Source" is selected and press [ENTER].

- (3) Press [▲, ▼] to select "DVD" and press [ENTER].

- When you set "Source" to "DVD", "VHS" is automatically selected on "Destination".

- (4) Press [◀].

- (5) Press [▼].

### 4 Set the recording mode.

- If you are not going to change the recording mode, press [▼], then skip to step 5.

#### ■ To Change the setting

- (1) Make sure "Mode" is selected and press [▶].
- (2) Make sure "Recording Mode" is selected and press [ENTER].
- (3) Select recording mode (SP, EP or VP) with [▲, ▼] and press [ENTER].
- (4) Press [◀].
- (5) Press [▼].

### 5 Register titles and playlists for transfer (copying).

- If you are going to transfer a registered list without making any changes to it, press [▼], then skip to step 6.

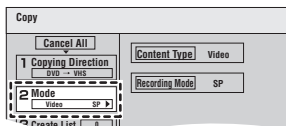
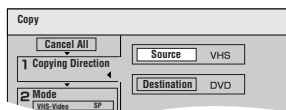

### ■ To set for the registration

- (1) Make sure "Create List" is selected and press [▶].
- (2) Make sure "New Entry (Total = 0)" is selected and press [ENTER].

- (3) Press [A] to select "Video" or press [B] to select "Playlists".
  - You can also select the view by selecting "Other View" from the SUB MENU.

- ① Press [SUB MENU].
  - ② Make sure "Other View" is selected and press [ENTER] twice.

- (4) Press [▲, ▼, ◀, ▶] to select the title or playlist and press [ENTER].

- You can register multiple titles or playlists to the copying list by repeating the above steps 2 to 4.

("To edit the transfer (copying) list" → 54)

- "To show other pages" (→ below)

- "Multiple editing" (→ below)

- (5) Press [◀].

- Before pressing [◀], make sure that the value on "Copying list" is smaller than the value on "Current Remaining".

- (6) Press [▼].

### 6 When you finish creating the copying list, Make sure to select "Start Copying" and press [ENTER].

- The confirmation screen appears.

### 7 Select "Yes" with [◀] and press [ENTER].

- Transfer (copying) is started.

### ■ To stop transfer (copying) in the middle

Press and hold [RETURN] for about 3 seconds or more.

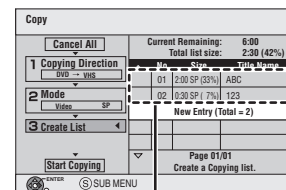
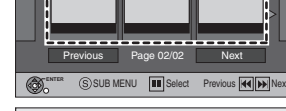
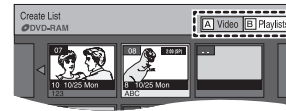
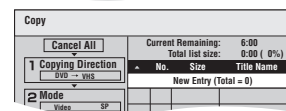
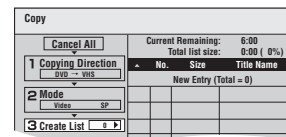

Registered titles

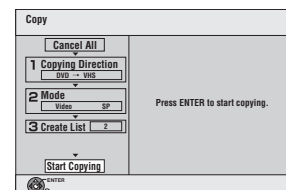

### Various operations

#### ■ To show other pages

Press [◀◀, SKIP] or [▶▶, SKIP].

- Press [▲, ▼, ◀, ▶] to select "Previous" or "Next" and press [ENTER] to show other pages.

#### ■ Multiple editing

Select with [▲, ▼, ◀, ▶] and press [■, PAUSE]. (Repeat) Press [ENTER] to register to the list.

- A check mark appears. Press [■, PAUSE] again to cancel.
- When you switch between the "Video" and "Playlists" tab, the check mark is canceled.
- Titles or playlists are registered to the copying list in ascending order of title number.

**To edit the transfer (copying) list**

Select the item in step 5 (4). (→ 53)

- 1 Select a desired item with [▲, ▼] and press [SUB MENU].
- 2 Press [▲, ▼] to select the operation and press [ENTER].

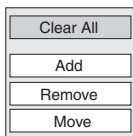

**Clear All:**

Clear all items registered on the transfer (copying) list.

- Press [◀, ▶] to select “Yes” and press [ENTER].

**Add:**

Add new items to the transfer (copying) list.

- Press [▲, ▼, ▶, ◀] to select the titles and playlists to be added and press [ENTER].

**Remove:**

Remove the selected item.

- Press [◀, ▶] to select “Yes” and press [ENTER].
- Multiple editing is possible. (→ 53)

**Move:**

Move selected items or change the order of items on the transfer (copying) list.

- Press [▲, ▼] to select the destination and press [ENTER].

**To cancel all registered transfer (copying) settings and lists**

After performing steps 1 to 4 (→ 53)

- 1 Press [▲, ▼] to select “Cancel All” and press [ENTER].
- 2 Press [◀, ▶] to select “Yes” and press [ENTER].

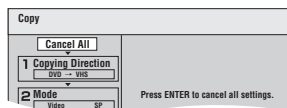

- The settings and lists may be canceled in the following situations.

- When a title or a playlist has been recorded or erased at the transfer (copying) source.
- When steps have been taken, for instance, to turn off the unit or open the tray.

**Transfer (Copying) a DVD-Video, finalized DVD-R, DVD-R DL, DVD-RW (DVD-Video format), +R, or +R DL**

You can transfer (copy) the contents of a disc being played onto a tape for the set time while playing the disc.

**Operations and on screen displays during transfer (copying) are also recorded.**

- Almost all DVD-Video on sale have been treated to prevent illegal copying, and cannot be transferred (copied).
- The following cannot be transferred (copied): DVD-Audio, Video CD, Audio CD and so on.

After performing steps 1 to 4 of “GUI (Graphical User Interface) Transfer (Copying)” (→ 53),

**5 Set “Time Limit”.**

- If you are not going to change the setting, press [▼], then skip to step 6.

**Setting the unit to transfer (copy) according to the set time**

- (1) Make sure “Time Limit” is selected and press [▶].
- (2) Make sure “Time Limit” is selected and press [ENTER].
  - Setting the unit to transfer (copy) all the content on the disc
- (3) Press [▲, ▼] to select “Off” and press [ENTER].
- (4) Press [◀].
  - Setting the transfer (copying) time
- (3) Press [▲, ▼] to select “On” and press [ENTER].
- (4) Press [▲, ▼] to select “Set time” and press [ENTER].
- (5) Press [◀, ▶] to select “Hour” and “Min.” and press [▲, ▼] to set the recording time, and then press [ENTER].
  - You can also set the set time with the numeric buttons.
  - Maximum recording time is 8 hours.
- (6) Press [◀].
- (7) Press [▼].

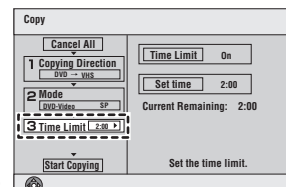

**6 Make sure “Start Copying” is selected and press [ENTER].**

Press [◀] to select “Yes” and press [ENTER] to start transfer (copy).

The disc top menu is displayed.

- Disc play automatically begins from title 1 when “First Title” is selected from the “Playback will start with:” menu when finalizing the disc (→ 61).

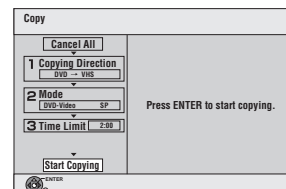

**7 When the top menu is displayed Press [▲, ▼, ▶, ◀] to select the title you want to start transferring (copying), and press [ENTER].**

- While playing in order, all the titles after the selected title are recorded until the set time.
- After the last title on the disc has finished playing, the top menu is recorded until the set time is reached.

**To stop transfer (copying) in the middle**

Press [■, STOP] or press and hold [RETURN] for about 3 seconds or more.

**Notes**

- The screen on the right (screen saver) is recorded at the beginning.
- It is recorded as 1 title from the start of transfer (copying) to the end (even if there are multiple programs).
- If play does not begin automatically or if the top menu does not display automatically, press [▶, PLAY] to start.
- REC only appears on the unit’s display when transferring from DVD-Video.

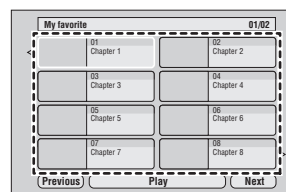

## Transfer (Copying) still picture

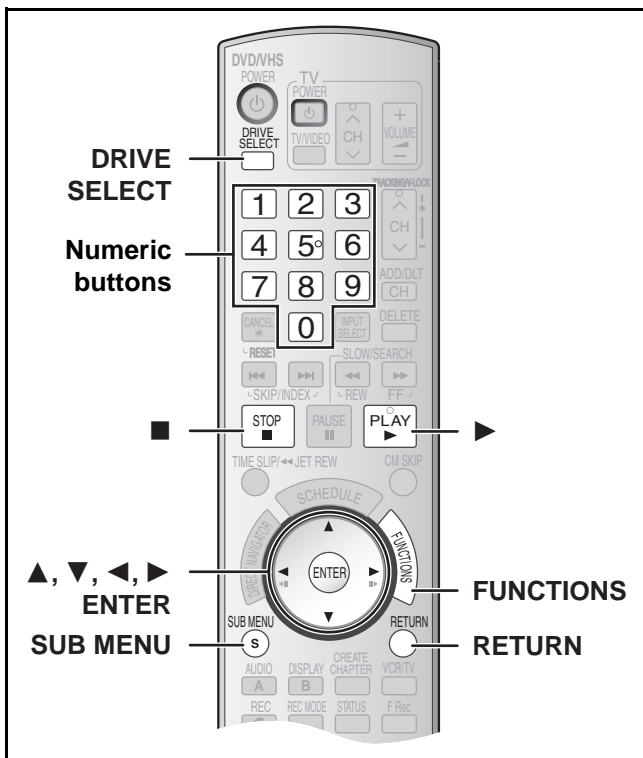

### RAM SD

- You can use SD Memory Cards with capacities from 8 MB to 2 GB (→ 8).
- Still pictures recorded on CD-R or CD-RW cannot be copied.

### SD

Put the card in the slot, and the menu (→ below) is automatically displayed. Press [▲, ▼] to select “Copy Pictures” and press [ENTER]. Then you can continue from step 4 right.

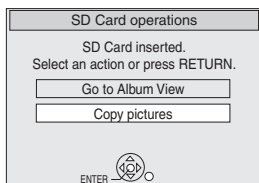

### Notes

- When copying the still pictures on a album by folder basis (→ 56, To register on a folder by folder basis) or card by card basis (→ right, Copy All Pictures), files other than the still picture files inside the folder will also be copied. (This does not apply to the lower folders contained inside the folders.)
- If still pictures are already contained inside the copy destination folder, the new still pictures are recorded following the existing still pictures.
- If the space on the destination drive runs out or the number of files/folders to be copied exceeds the maximum, copying will stop partway through.
- When a name has not been input for the copy source folder, it is possible that this folder's name will not be the same on the copy destination. It is recommended that you input a folder name before copying (→ 48).
- Print number setting (DPOF) is not copied.
- The sequence in which the still pictures are registered on the copy list may not be the same at the copy destination.

### ■ Copying all the still pictures on a card —Copy All Pictures

#### SD → RAM

#### Preparation

- Select the unit viewing channel (e.g. AV input) on the TV.
- Release protection (disc → 60, cartridge → 60). **RAM**
- Insert a disc and confirm there is sufficient empty space for recording on it (→ 24, 40).
- Inserting, Removing the SD card. (→ 11)
- Press [DRIVE SELECT] to select the SD drive.

#### 1 While stopped

Press [FUNCTIONS].

#### 2 Press [▲, ▼] to select “Other Functions” and press [ENTER].

#### 3 Press [▲, ▼] to select “Copy all Pictures” and press [ENTER].

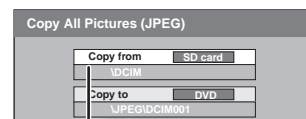

- If there is a multiple number of higher folders recognizable, you can switch them using [◀, ▶].

#### 4 Press [▲, ▼, ◀, ▶] to select “Copy” and press [ENTER].

### ■ To stop transfer (copying) in the middle

Press and hold [RETURN] for about 3 seconds or more.

### ■ To return to the previous screen

Press [RETURN].

### ■ GUI (Graphical User Interface) Transfer (Copying)

#### RAM SD

#### 1 While stopped

Press [FUNCTIONS].

#### 2 Press [▲, ▼] to select “Copy” and press [ENTER].

#### 3 Set “Copying Direction”.

- If you are not going to change the copy direction, press [▼], then skip to step 4.

#### ■ To change the setting

(1) Make sure “Copying Direction” is selected and press [▶].

(2) Make sure “Source” is selected and press [ENTER].

(3) Press [▲, ▼] to select the drive and press [ENTER].

(4) Press [▲, ▼] to select “Destination” and press [ENTER].

(5) Press [▲, ▼] to select the drive and press [ENTER].

- The same drive as the copy source can be selected.

(6) Press [◀].

(7) Press [▼].

#### 4 Press [▼] to select “Create List”.

- “Mode” does not need to be set as “Content Type” and “Recording Mode” are automatically set.

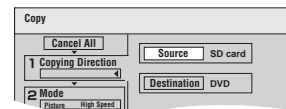

**5 Register still pictures for transfer (copying).**

- If you are going to transfer a registered list without making any changes to it, press [▼], then skip to step 6.
- You can register still pictures or still picture folders.
- Still pictures and folders cannot be registered on the same list.

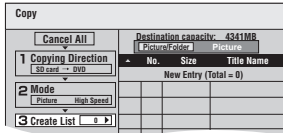

**■ To register individual still pictures**

- (1) Make sure "Create List" is selected and press [▶].
- (2) Make sure "New Entry (Total = 0)" is selected and press [ENTER].
- (3) Press [▲, ▼, ◀, ▶] to select a still picture and press [ENTER].
  - You can register multiple still pictures to the copying list by repeating the above steps 2 to 3. (Copying list display and convenient functions: → right)
  - "To show other pages" → below
  - "Multiple editing" → below
- (4) Press [◀].
- (5) Press [▼].

**■ To register on a folder by folder basis**

- (1) Make sure "Create List" is selected and press [▶].
- (2) Press [▲, ▼] to select "Picture/Folder" and press [ENTER].
- (3) Press [▲, ▼] to select "Folder" and press [ENTER].
- (4) Press [▲, ▼] to select "New Entry (Total = 0)" and press [ENTER].
- (5) Press [▲, ▼] to select the folder and press [ENTER].
  - You can register multiple still folders to the copying list by repeating the above steps 4 – 5. (Copying list display and convenient functions: → right)
  - "To show other pages" → below
  - "Multiple editing" → below
- (6) Press [◀].
- (7) Press [▼].

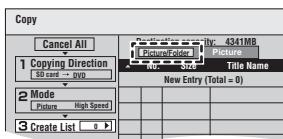

**6 When you finish creating the copying list, Make sure to select "Start Copying" and press [ENTER].**

- For individual still pictures only  
When specifying another folder as the copying destination, select "Folder".

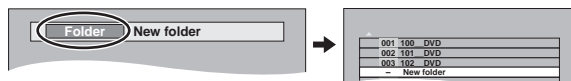

**7 Select "Yes" with [◀] and press [ENTER].**

- Transfer (copying) is started.

**■ To stop transfer (copying) in the middle**

Press and hold [RETURN] for about 3 seconds or more.

**■ To return to the previous screen**

Press [RETURN].

**Various operations**

**■ To show other pages**

- Press [◀◀, SKIP] or [▶▶, SKIP].
- Press [▲, ▼, ◀, ▶] to select "Previous" or "Next" and press [ENTER] to show other pages.

**■ Multiple editing**

- Select with [▲, ▼, ◀, ▶] and press [||, PAUSE]. (Repeat) Press [ENTER] to register to the list.
- A check mark appears. Press [||, PAUSE] again to cancel.
  - Still picture or folder are registered to the copying list in ascending order of number.

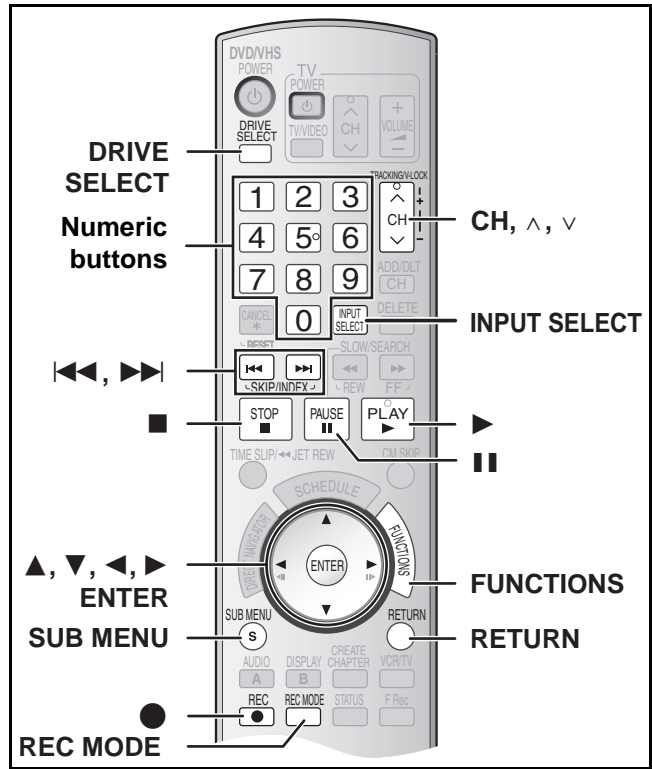

**To edit the transfer (copying) list**

Select the item in step 5–(3) (for a still picture) or 5–(5) (for a folder) (→ left)

- 1 Select a desired item with [▲, ▼] and press [SUB MENU].
- 2 Press [▲, ▼] to select the operation and press [ENTER].

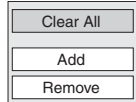

**Clear All:**

Clear all items registered on the transfer (copying) list.

- Press [◀] to select "Yes" and press [ENTER].
- Add:**  
Add new items to the transfer (copying) list.
- Press [▲, ▼, ◀, ▶] to select the still picture or folder to be added and press [ENTER].
- Remove:**  
Remove the selected item.
- Press [◀] to select "Yes" and press [ENTER].
  - Multiple editing is possible. (→ left)

**To cancel all registered transfer (copying) settings and lists**

After performing steps 1 to 2 (→ 55)

- 1 Press [▲, ▼] to select "Cancel All" and press [ENTER].
- 2 Press [◀] to select "Yes" and press [ENTER].

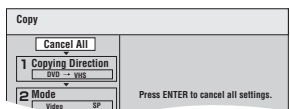

- The settings and lists may be canceled in the following situations.
  - When a title or still picture has been recorded or erased at the transfer (copying) source.
  - When steps have been taken, for instance, to turn off the unit, remove the card, open the tray, change the copy direction, etc.

**To select another folder**

- 1 Press [▲, ▼, ◀, ▶] to select "Folder" and press [ENTER].
  - If you want to switch to another higher folder (→ below)
- 2 Press [▲, ▼] to select the folder and press [ENTER].



- You can also select folders by entering a 3-digit number with the numeric buttons.  
e.g.: "5": [0]→[0]→[5]  
"15": [0]→[1]→[5]
- The still pictures of different folders cannot be registered on the same list.

**To switch to another higher folder**

Only when selecting the source folder  
If there is a multiple number of higher folders recognizable,  
While the screen on the right appears

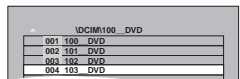

- 1 Press [SUB MENU].
- 2 Press [▲, ▼] to select "Select Root Folder" and press [ENTER].
- 3 Press [◀, ▶] to select the higher folder and press [ENTER].
- 4 Press [▲, ▼] to select the desired folder and press [ENTER].



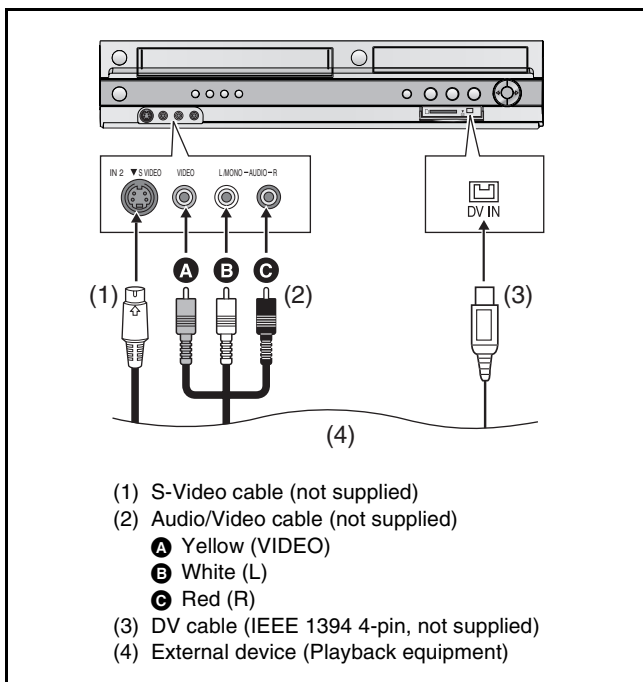

**Before connecting any cables, first make sure that the power for the unit and the external device are off. Then, after connecting cables, turn on both.**

## Recording from an external device

**When connecting the IN2 input terminals on the front of the unit**

- You can also connect to the IN1 input terminals on the rear of the unit.

### Notes

- When recording using the unit's input terminals, only the sound received at the time of recording will be recorded. As long as secondary audio that is recorded on the media in the external device is not output to the unit in play, it is not recorded.
- If the audio output of the other equipment is monaural, connect to L/MONO. (Both left and right channels are recorded when connected through L/MONO.)
- The S-VIDEO terminal achieves a more vivid picture than the VIDEO terminal.

### Preparation

DVD **RAM -R -R DL -RW(V) +R +R DL +RW**

- Release protection (disc → 60, cartridge → 60). **RAM**
- Select DVD side with pressing [DRIVE SELECT].

### VHS

- Insert a video cassette with an accidental erasure prevention tab. (→ 24)
- Select VHS side with pressing [DRIVE SELECT].

### 1 Press [REC MODE] to select the recording mode. (DVD → 26, VHS → 26)

- DVD **RAM -R -R DL -RW(V) +R +R DL +RW**  
 - It is also possible to perform Flexible Recording (FR). (→ 29)

### 2 While stopped

Press [CH, √, ^] or [INPUT SELECT] to select the input channel for the equipment you have connected.

- Select IN1 or IN2.

## DVD

Follow the above steps 1 to 2.

### 3 Start play on the external device.

### 4 Press [●, REC] at the point where you want to start recording.

## VHS

Follow the above steps 1 to 2.

### 3 Press [▶, PLAY].

- Start playing the video cassette and find the recording start point.

### 4 Press [II, PAUSE], then press [●, REC].

- Put the unit in recording standby mode.

### 5 Start play on the external device.

### 6 Press [II, PAUSE] at the point where you want to start recording.

### ■ To skip unwanted parts

Press [II, PAUSE] to pause recording. (Press again to restart recording.)

### ■ To stop recording

Press [■, STOP].

### For your reference

- Almost all videos and DVD software on sale have been treated to prevent illegal copying. Such software cannot be recorded.

## DV camcorder recording

**RAM -R -RW(V) +R +RW**

Programs are recorded as a title while at the same time chapters are created at each break in the images and the playlist is created automatically. **RAM**

### Preparation

- Turn on the main unit and DV equipment.
- Select the type of audio recording from "Select Audio Channel for DV Input" in the Audio menu. (→ 64)  
 When recording from DV equipment (e.g., digital video camcorder), you can record audio/video recordings from DV tape only.
- Pause play on the DV equipment at the point you want recording to start.
- Press [REC MODE] to select the recording mode.

### 1 While stopped

Press [FUNCTIONS].

### 2 Press [▲, ▼] to select "Other Functions" and press [ENTER].

### 3 Press [▲, ▼] to select "DV Camcorder Rec." and press [ENTER].

### 4 Press [◀, ▶] to select "Rec." and press [ENTER].

### When recording finishes

The confirmation screen appears. Press [ENTER] to finish DV automatic recording.

### To stop recording

Press [■, STOP]. The confirmation screen appears. Press [ENTER].

### Notes

- Only one piece of DV equipment (e.g., digital video camcorder) can be connected to the unit via the DV IN terminal.
- If you use video camcorders from other manufacturer's these are not guaranteed to work.
- If the DV equipment is in a mode for operating the SD card, it is not possible to record with "DV Camcorder Rec."
- It is not possible to operate the unit from the connected DV equipment.
- The DV IN terminal on this unit is for use with DV equipment only. (It cannot be connected to a computer, etc.)
- The DV equipment name may not be shown correctly.
- Depending on the DV equipment, the images or audio may not be input properly.
- The date and time information on the tape in the DV equipment will not be recorded.
- You cannot record and play simultaneously.

If the DV automatic recording function does not work properly, check the connections and DV equipment settings, and turn the unit off and back on.  
**If that does not work, follow the instructions for Recording from an external device (→left).**

# Entering text

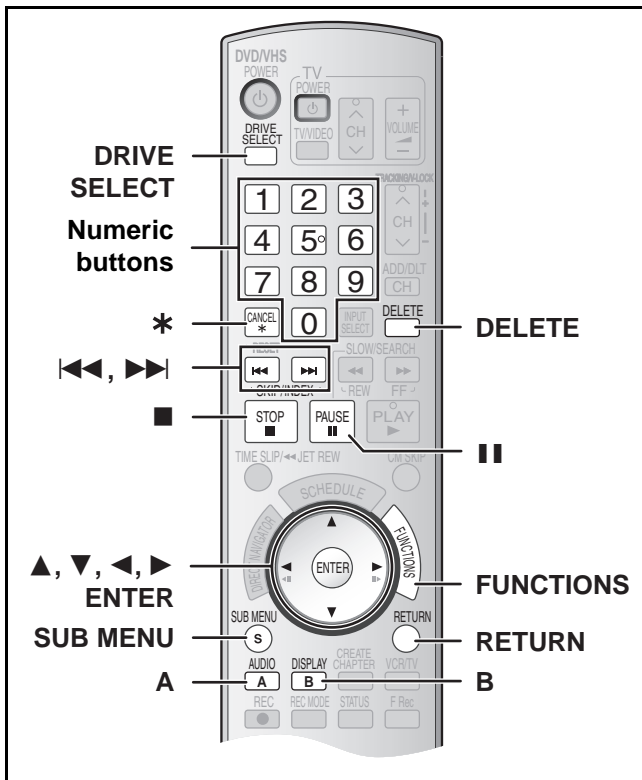

## Entering text

**RAM** -R -R DL -RW(V) +R +R DL +RW SD

You can give names to recorded titles, etc.

The maximum number of characters:

| RAM                           | Characters |
|-------------------------------|------------|
| • Title                       | 64         |
| • Title (scheduled recording) | 44         |
| • Playlist                    | 64         |
| • Album                       | 36         |
| • Disc                        | 64         |

| -R -R DL -RW(V) +R +R DL +RW | Characters |
|------------------------------|------------|
| • Title                      | 44         |
| • Disc                       | 40         |

| SD      | Characters |
|---------|------------|
| • Album | 36         |

### Note

- If a name is long, parts of it may not be shown in some screens.

### Preparation

- Insert a disc or card.
- Release protection (disc → 60, title → 42, album → 48, cartridge → 60, card → 60). **RAM SD**
- Press [DRIVE SELECT] to select the drive (DVD or SD).

### 1 Show Enter Name screen.

Refer to the following pages regarding display of the Enter Name Screen.

|                               |        |
|-------------------------------|--------|
| • Title                       | (→ 42) |
| • Title (scheduled recording) | (→ 30) |
| • Disc                        | (→ 60) |
| • Playlist                    | (→ 45) |
| • Album                       | (→ 48) |

**Name field:** shows the text you have entered

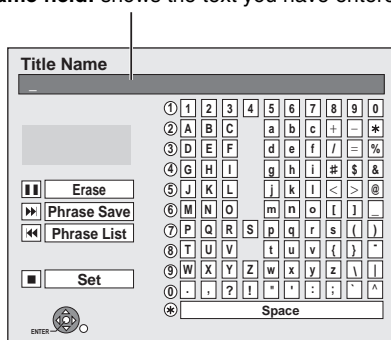

### 2 Use [▲, ▼, ◀, ▶] to select the character you want to enter and press [ENTER].

Repeat this step to enter other characters.

#### • To erase a character

Press [▲, ▼, ◀, ▶] to select the character in the name field and press [II, PAUSE].

#### • Using the numeric buttons to enter characters

e.g., entering the letter "R".

- (1) Press [7] to move to the 7th row.
- (2) Press [7] twice to highlight "R".
- (3) Press [ENTER].

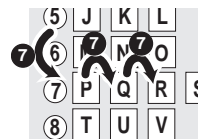

#### • To enter space

Press [\*, CANCEL] and press [ENTER].

#### • Save/recall phrased (→ below)

### 3 After you have finished naming Press [■, STOP].

The title is entered and the screen disappears.

#### ■ To cancel in the middle

Press [RETURN].

- Characters will not be saved.

#### ■ To save phrases

You can save frequently used phrases and recall them later.

Maximum number of saved phrases: 20

Maximum number of characters per phrase: 20

- After entering the phrase (step 1 to 2, "Entering text")

**1** Press [▲, ▼, ◀, ▶] to select "Phrase Save" and press [ENTER].

- You can also press [▶▶], SKIP to select "Phrase Save".

**2** Press [◀, ▶] to select "Save" and press [ENTER].

- Press [RETURN] to cancel.

#### ■ To recall a saved phrases

**1** Press [▲, ▼, ◀, ▶] to select "Phrase List" and press [ENTER].

- You can also press [◀◀], SKIP to select "Phrase List".

**2** Press [▲, ▼, ◀, ▶] to select the phrase to be recalled and press [ENTER].

#### ■ To erase saved phrases

**1** Press [▲, ▼, ◀, ▶] to select "Phrase List" and press [ENTER].

- You can also press [◀◀], SKIP to select "Phrase List".

**2** Press [▲, ▼, ◀, ▶] to select the phrase to be erased.

**3** Press [SUB MENU] to show "Erase Phrase" and press [ENTER].

**4** Press [◀, ▶] to select "Erase" and press [ENTER].

**5** Press [RETURN].

#### For your reference

If you enter a long name, only part of it is shown in the TOP MENU after finalization (→ 61). When entering a title name, the name that will appear in the TOP MENU can be previewed in "Top Menu Preview (Finalized Disc)" window.





# DVD and card Management

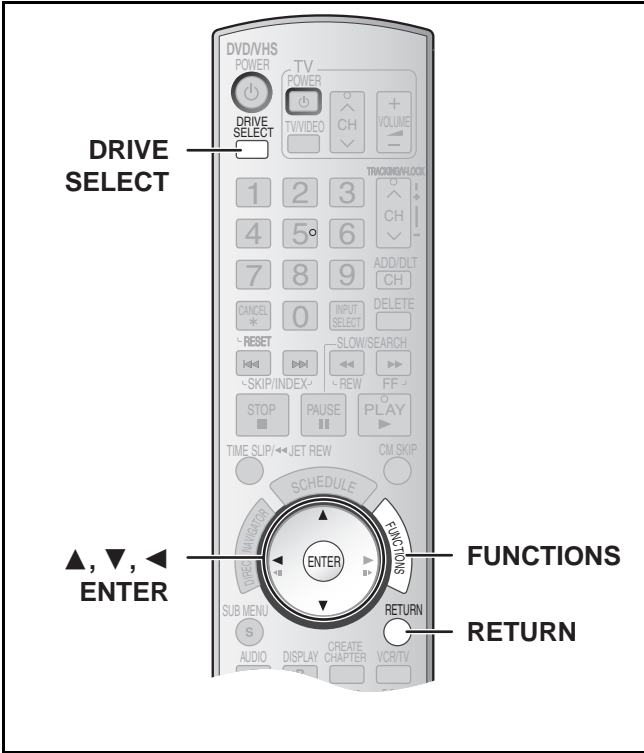

RAM -R -R DL -RW(V) +R +R DL +RW SD

## Preparation

• Please protection (disc → right, cartridge → right, card → right).

• **SD**

• disc or card.

• [DRIVE SELECT] to select the drive (DVD or SD).

• Stopped

• [FUNCTIONS].

• “Other Functions” with [▲, ▼] and press

e.g., **RAM**

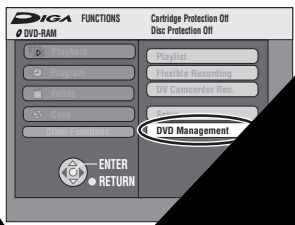

• “” or “Car”  
• and pr

## Providi

RAM -R -R DL

• Follow steps

4 Select “D  
[ENTER]

Refer to “Enteri

• The disc name

• With a finalize  
Menu.

## Setting 1

RAM

• Follow steps 1

This allows you t

and release disc

4 Select “D  
[ENTER].

5 Select “Ye

• To protect

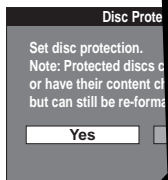

• To releas

## Deleting all contents of a disc or card –Format

**RAM -RW(V) +RW -RW(VR) SD**

**+R +R DL** (New disc only)

- Follow steps 1 to 3 of “DVD and card Management”.

**Formatting deletes all contents (including computer data), and they cannot be restored. Check carefully before proceeding.**

The contents are deleted when you format a disc even if you have set protection.

- 4 Select “Format Disc (DVD)” or “Format memory card” with [**▲**, **▼**] and press [**ENTER**].

- 5 Select “Yes” with [**◀**] and press [**ENTER**].

e.g.: **RAM**



- 6 Select “Start” with [**◀**] and press [**ENTER**].

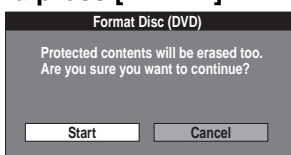

- Formatting starts.
- A message appears when formatting is finished.

### Notes

- Formatting normally takes a few minutes; however it may take up to a maximum of 70 minutes **RAM**.
- Do not disconnect the AC power supply cord while formatting. This can render the disc unusable.

- 7 Press [**ENTER**].

### ■ To stop formatting **RAM**

Press [**RETURN**].

- You can cancel formatting if it takes more than 2 minutes. The disc must be reformatted if you do this.

### Notes

- When a disc or card has been formatted using this unit, it may not be possible to use it on any other equipment.
- DVD-R, DVD-R DL and CD-R/RW cannot be formatted.
- You can format DVD-RW only as DVD-Video format on this unit.
- The disc cannot be formatted if the write protect tab (→ 60) is switched to “PROTECT”. Release the protection to continue.
- The message “Unable to format” appears when trying to format discs the unit cannot use.

## Selecting whether to show the Top Menu first –Playback will start with:

**-R -R DL -RW(V) +R +R DL +RW**

- Follow steps 1 to 3 of “DVD and card Management”.

Select whether to show the top menu after finalizing the disc. Do this before finalizing the disc.

- 4 Select “Playback will start with:” with [**▲**, **▼**] and press [**ENTER**].

- 5 Use [**▲**, **▼**] to select a desired item and press [**ENTER**].

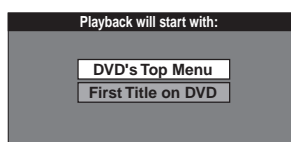

- DVD's Top Menu: The top menu appears first.
- First Title on DVD: The disc content is played without displaying the top menu.

## Enabling discs to be played on other equipment –Finalize

**-R -R DL -RW(V) +R +R DL**

- Follow steps 1 to 3 of “DVD and card Management”.

- Make selection from “Selecting whether to show the Top Menu first –Playback will start with:” before finalizing the disc. (→ lower left)

You can play DVD-R, DVD-R DL, DVD-RW (DVD-Video format), +R or +R DL on compatible DVD players by finalizing it on the unit, effectively making it into DVD-Video that complies with DVD-Video standards.

The menu you create with the unit can also be used on DVD players.

- 4 Select “Finalize” with [**▲**, **▼**] and press [**ENTER**].

- 5 Select “Yes” with [**◀**] and press [**ENTER**].

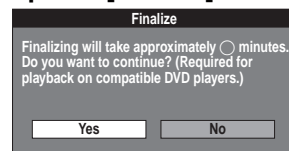

- 6 Select “Start” with [**◀**] and press [**ENTER**].

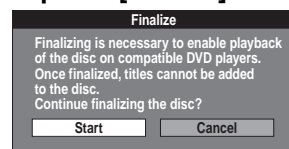

- Finalizing starts.
- You cannot cancel finalizing.
- A message appears when finalizing is finished.

### Notes

- Finalizing can take a few minutes, up to a maximum of 15 minutes, depending on the remaining space on the disc. (**-R DL +R DL** up to 60 minutes)
- Do not disconnect the AC power supply cord while finalizing. This can render the disc unusable.

- 7 Press [**ENTER**].

### Notes

- When finalizing a high-speed recording compatible disc, it may take longer than displayed on the confirmation screen (approximately 4 times).
- **After finalizing**
  - The disc becomes play-only and you can no longer record or edit it. **-R -R DL +R +R DL**
  - You can record and edit the disc after formatting (→ left) although it becomes play-only after finalizing. **-RW(V)**
  - DVD-R, DVD-R DL, DVD-RW (DVD-Video format), +R or +R DL finalized on the unit may not be playable on other players depending on the condition of the recording.
  - There is a pause of several seconds between titles and chapters during play.
  - Titles are divided into about 5-minute chapters\* (**-R DL +R DL** 8 minutes)
  - \* This time varies greatly depending on the condition and mode of recording.

- Visit Panasonic's homepage for more information about DVDs.  
<http://www.panasonic.com/playDVD-R>

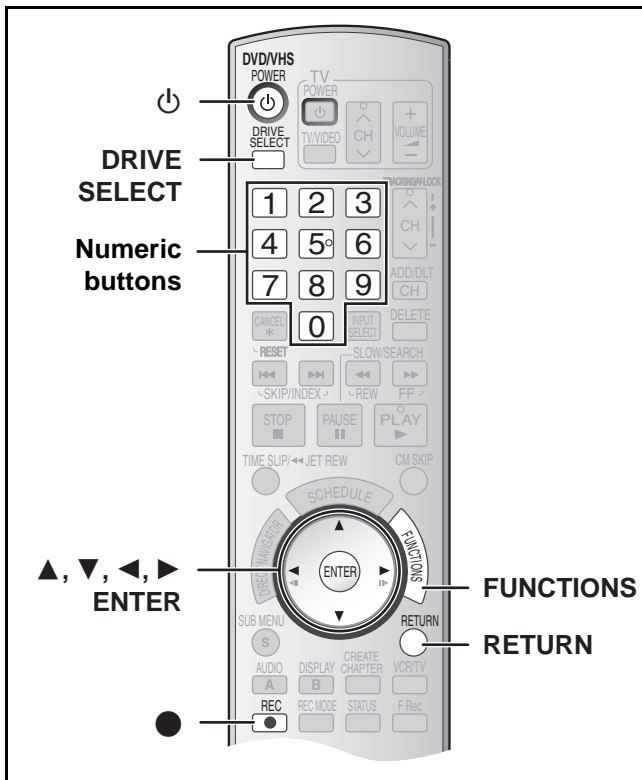

**Enabling the second layer on DL (dual-or double-layer on single side) discs to be recordable  
–Close First Layer**

**-R DL +R DL**

• Follow steps 1 to 3 of “DVD and card Management”.

DVD-R DL and +R DL discs have two layer of recording surface on one side. this unit does not offer seamless recording on two layers. Recording stops when space on the first layer becomes full. You must close the first layer to start recording on the second layer. Closing makes the first layer unavailable for recording (edition is still available. You cannot cancel closing. Make certain before proceeding.

- 4 Press [▲, ▼] to select “Close First Layer” and press [ENTER].**
- 5 Press [◀, ▶] to select “Yes” and press [ENTER].**
- 6 Press [◀, ▶] to select “Start” and press [ENTER].**

Closing the layer starts. You cannot cancel closing. Closing the layer can take several minutes, up to a maximum of 30 minutes, depending on the remaining space on the first layer.

**Note**

- Do not disconnect the AC power supply cord while closing the layer. This will render the disc unusable.

- 7 Press [ENTER].**

**■ To confirm the layer you can record**

You can confirm the remaining recording time on the layer you can record.

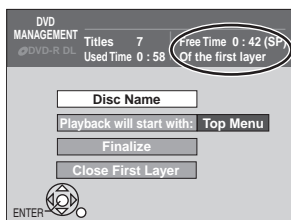

**Notes**

- You cannot close the first layer when it has no recording.
- By closing the layer, you can record or edit discs that have been recorded on the second layer by other equipment.

**Creating Top Menu  
–Create DVD Top Menu**

**+RW**

- Follow steps 1 to 3 of “DVD and card Management”.

+RW discs contain no Top Menu data. Top menu is a convenient function. We recommend you to create the menu before playing a +RW disc on other equipment.

- 4 Press [▲, ▼] to select “Create DVD Top Menu” and press [ENTER].**
- 5 Press [◀, ▶] to select “Yes” and press [ENTER].**
- 6 Press [◀, ▶] to select “Start” and press [ENTER].**  
Creating Top Menu starts. You cannot cancel creating. Creating Top Menu can take a few minutes.
- 7 Press [ENTER].**

**Notes**

- Recording or editing on the disc may delete the menu. In that case, create the menu again.
- You cannot use the title menu for playing on this unit.

## Common procedures

Use the following procedure to change the settings if necessary.

- 1 While stopped Press [FUNCTIONS].
- 2 Select "Other Functions" with [▲, ▼] and press [ENTER].
- 3 Select "Setup" with [▲, ▼] and press [ENTER].

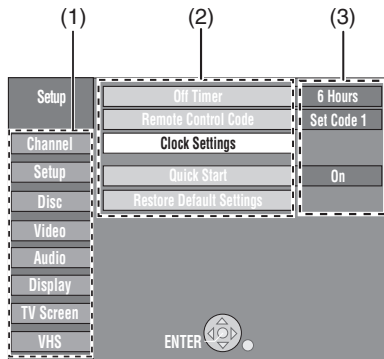
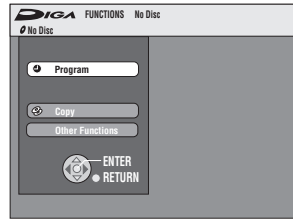

- (1) Menus  
(2) Items  
(3) Options

- 4 Select a menu with [▲, ▼] and press [◀, ▶].
- 5 Select an item to be changed with [▲, ▼] and press [ENTER].
- 6 Select an option with [▲, ▼] and press [ENTER].
  - Some options require different operations. Follow the displayed instructions.

### ■ To return to the previous screen

Press [RETURN]. Even if you have changed an option, the change is not activated until you press [ENTER].

### ■ To exit the screen

Press [RETURN] several times.

### For your reference

- The settings remain intact even if you switch the unit to standby.

## Entering a password (Ratings)

You can limit play of DVDs unsuitable for some audiences (children, for example). Play and changes to the settings are not possible unless you enter a password.

### Preparation

- Select DVD side with pressing [DRIVE SELECT].

### When setting ratings

The password screen is shown when you select levels 0 to 7.

- 1 Input a 4-digit password with the numeric buttons.
  - If you enter a wrong number, press [◀] to erase it before you press [ENTER].
  - Do not forget your password.

2 Press [ENTER].

3 Press [ENTER].

The password is entered and the unit is locked.

Now, when you insert a DVD-Video that exceeds the ratings limit you set, a message appears on the TV. Follow the on-screen instructions.

### When changing ratings

The password screen is shown when you select "Ratings" (→ 64)

- 1 Input a 4-digit password with the numeric buttons and press [ENTER].

**Unlock Recorder:** To unlock the unit and return the rating to 8

**Change Password:** To change your password

**Change Level:** To change the rating level

**Temporary Unlock:** To temporarily unlock the unit (the unit locks again if you switch it to standby or open the disc tray)

- 2 Select a desired item with [▲, ▼] and press [ENTER].

Actual screens depend on the operation. Follow the on-screen instructions.

## Summary of settings

This description shows the initial settings for the unit. For details on menu operation. (→ left)

- Underlined items are the factory default settings.

- indicates settings effective for both DVD and VHS.

- indicates settings effective for DVD only.

- indicates settings effective for VHS only.

### ■ Channel

#### Signal Source (RF IN) (→ 19)

Select to suit the type of antenna you are using.

[Antenna] [CableTV]

#### Set Channels Automatically (→ 19)

#### Preset Channel Captions (→ 20)

#### Manual Channel Captions (→ 20)

### ■ Setup

#### Off Timer

Select how long the unit remains on when it is not being used.

[2 Hours] [6 Hours] [Off]

#### Remote Control Code (→ 21)

[Set Code 1] [Set Code 2] [Set Code 3]

#### Clock Settings

Press [ENTER] to show the following settings.

##### Set Clock Automatically (→ 22)

##### Set Clock Manually (→ 19)

##### Adjust Time Zone (→ 22)

This corrects the time set in Auto Clock Setting.

The status is not displayed on the Setup menu when the Auto Clock Setting is not set.

[-1] [0] [+1]

#### Quick Start

1 Sec. Quick Start for Recording on DVD-RAM\*

\* From the power off state, recording on DVD-RAM starts about 1 second after first pressing the [⏻, DVD/VHS POWER] and then sequentially pressing the [●, REC] (Quick Start Mode).

Power consumption is also higher when the unit is turned off if this is set to "On".

[On] [Off]

#### Restore Default Settings

This returns Setup menus to default settings, except for the clock, channel settings, ratings level, and on-screen language.

[Yes] [No]

- Underlined items are the factory default settings.

## ■ Disc

### Settings for Playback

Press [ENTER] to show the following settings.

**Ratings** ("Entering a password (Ratings)" → 63)

Set a ratings level to limit DVD-Video play.

**Setting ratings (When level 8 is selected)**

[8 No Limit]: All DVD-Video can be played.

[1] to [7]: Prohibits play of DVD-Video with corresponding ratings recorded on them.

[0 Lock All]: Prohibits play of all DVD-Video.

**Changing ratings (When level 0 to 7 is selected)**

[Unlock Recorder] [Change Password]

[Change Level] [Temporary Unlock]

**Play DVD-Audio in Video Mode**

Select "Video Mode (Video On)" to play DVD-Video content on some DVD-Audio.

[Video Mode (Video On)] [Audio Mode (Video Off)]

|                              |  |
|------------------------------|--|
| <b>Video Mode (Video ON)</b> | The setting returns to "Audio Mode (Video Off)" when you change the disc or turn the unit off. |
|------------------------------|--|

**Audio Language**

[English] [French] [Spanish] [Original] [Other \*\*\*\*]

**Subtitle Language**

[Automatic] [English] [French] [Spanish] [Other \*\*\*\*]

**Menu Language**

[English] [French] [Spanish] [Other \*\*\*\*]

Choose the language for audio, subtitles and disc menus. **DVD-V**

- If a language which is not recorded is selected, or if languages are already fixed on the disc, the language set as the default on the disc will be played instead.

**Original**

The original language of each disc will be selected.

**Other \*\*\*\***

This is the language code setting.

Input a code number with the numeric buttons.

(→ 66, "Language code list")

**Automatic**

If the language selected for "Audio Language" is not available, subtitles of that language will automatically appear if available on the disc.

## Settings for Recording

Press [ENTER] to show the following settings.

**Recording Time in EP Mode**

Select the maximum number of hours for recording in EP mode

[→ 26, "Recording modes and approximate recording times (DVD)"].

[EP-Extended Play (6H)] [EP-Extended Play (8H)]

|                              |  |
|------------------------------|--|
| <b>EP-Extended Play (6H)</b> | You can record for 6 hours on an unused 4.7 GB disc. |
| <b>EP-Extended Play (8H)</b> | You can record for 8 hours on an unused 4.7 GB disc. |

## ■ Video

**Still Mode (paused video)**

Select the type of picture shown when you pause play.

(→ 76, "Frame and field")

[Automatic] [Field] [Frame]

|              |  |
|--------------|--|
| <b>Field</b> | Select if jittering occurs when "Automatic" is selected.                                   |
| <b>Frame</b> | Select if you cannot see small text or fine patterns clearly when "Automatic" is selected. |

**Black Level Control**

Select "Normal", "Lighter" or "Darker" to adjust the black level control to the desired setting for picture enhancement.

Press [ENTER] to show the following settings.

**Input Level**

Adjusts the black level of the input signal.

[Lighter] [Darker]

**Output Level (Composite/SVideo)**

Adjusts the black level of the output signal from the VIDEO OUT and S VIDEO OUT terminal.

[Lighter] [Darker]

**Output Level (Component)**

Adjusts the black level of the output signal from the COMPONENT VIDEO OUT (Y/Pb/Pr) terminals.

[Lighter] [Normal] [Darker]

## ■ Audio

**Dynamic Range Compression**

**DVD-V** (Dolby Digital only)

Change the dynamic range (→ 76) for easier listening in low volume.

[On] [Off]

**Multi-channel TV sound (MTS)**

**-R -R DL -RW(V) +R +R DL +RW**

Select whether to record the main or secondary audio type (SAP) when recording or transferring (copying) to DVD-R, DVD-RW (DVD-Video format) or +R. (You cannot select the audio type on the unit when recording audio to DVD-R, DVD-RW (DVD-Video format) or +R from an external device. Select it on the external device.)

[Main] [Secondary Audio Program (SAP)]

**Digital Audio Output**

Change the settings when you have connected equipment through the unit's DIGITAL AUDIO OUT terminal (→ 16).

Press [ENTER] to display the menu.

**PCM Down Conversion**

Select how to output audio with a sampling frequency of 96 kHz or 88.2 kHz.

- Signals are converted to 48 kHz or 44.1 kHz despite the above settings if the signals have a sampling frequency of over 96 kHz or 88.2 kHz, or the disc has copy protection.

[On] [Off]

|            |  |
|------------|--|
| <b>On</b>  | Signals are converted to 48 kHz or 44.1 kHz. (Choose when the connected equipment cannot process signals with sampling frequency of 96 kHz or 88.2 kHz.) |
| <b>Off</b> | Signals are output as 96 kHz or 88.2 kHz. (Choose when the connected equipment can process signals with sampling frequency of 96 kHz or 88.2 kHz.)       |

**Dolby Digital**

Choose whether to output by "Bitstream" which processes Dolby Digital signals on other connected equipment or to convert the signals to "PCM (2ch)" on the unit before output.

[Bitstream] [PCM]



|                  |   |
|------------------|---|
| <b>Bitstream</b> | When you have connected the unit to a piece of equipment having Dolby Digital logo.             |
| <b>PCM</b>       | When you have connected the unit to a piece of equipment that doesn't have Dolby Digital logo*. |

**DTS**

Choose whether to output by "Bitstream" which processes DTS signals on other connected equipment or to convert the signals to "PCM (2ch)" on the unit before output.

[Bitstream] [PCM]



|                  |   |
|------------------|---|
| <b>Bitstream</b> | When you have connected the unit to a piece of equipment having DTS logo.             |
| <b>PCM</b>       | When you have connected the unit to a piece of equipment that doesn't have DTS logo*. |

- \* Incorrect settings can cause noise to be output which can be harmful to your ears and speakers, and audio will not be recorded properly on media such as mini discs.

**Select Audio Channel for DV Input**

You can select the kind of audio when recording from the unit's DV in terminal. (→ 57)

[Stereo 1] [Stereo 2] [Mix]

|                 |  |
|-----------------|--|
| <b>Stereo 1</b> | Records audio (L1, R1)   |
| <b>Stereo 2</b> | Records added audio such as narration (L2, R2) subsequent to original recording. |
| <b>Mix</b>      | Records both Stereo 1 and Stereo 2.  |





## Changing the speaker setting to suit your speakers

Change the speaker setting to suit your speakers

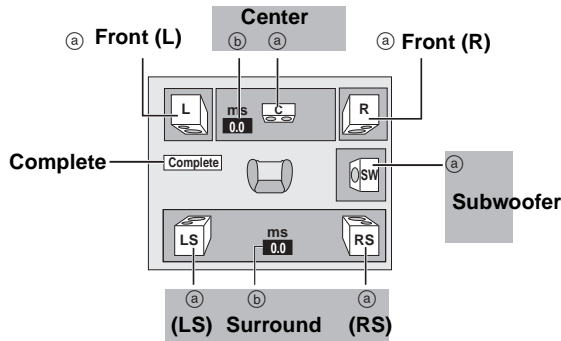

### To set the speaker presence and size (a)

- 1 Press [**▲**, **▼**, **◀**, **▶**] to select the speaker icon (a) and press [**ENTER**].
- 2 Press [**▲**, **▼**] to select the setting and press [**ENTER**].

Icon examples:

Surround speaker (LS)

• **Large:** Select when the speaker supports low-frequency (under 100 Hz) reproduction.



Large

Small

No

• **Small:** Select when the speaker does not support low-frequency reproduction.

If the subwoofer is set to "No", the front speakers will automatically be set to "Large". (In this case, we recommend connecting a speaker that can reproduce bass below 100 Hz.)

### To set the delay time (b)

(Effective only when playing multi-channel audio)

If either distance (c) or (e) is less than (d), find the difference in the relevant table and change to the recommended setting.

- 1 Press [**▲**, **▼**, **◀**, **▶**] to select an item (b) and press [**ENTER**].
- 2 Press [**▲**, **▼**] change the content and press [**ENTER**].

### ④ Center speaker

| Difference   | Setting |
|--|---------|
| Approx. 34 cm (1 <sup>1</sup> / <sub>10</sub> feet)  | 1.0 ms  |
| Approx. 68 cm (2 <sup>1</sup> / <sub>5</sub> feet)   | 2.0 ms  |
| Approx. 102 cm (3 <sup>3</sup> / <sub>10</sub> feet) | 3.0 ms  |
| Approx. 136 cm (4 <sup>2</sup> / <sub>5</sub> feet)  | 4.0 ms  |
| Approx. 170 cm (5 <sup>1</sup> / <sub>2</sub> feet)  | 5.0 ms  |

### ⑤ Surround speakers

| Difference   | Setting |
|--|---------|
| Approx. 170 cm (5 <sup>1</sup> / <sub>2</sub> feet)  | 5.0 ms  |
| Approx. 340 cm (11 feet)                             | 10.0 ms |
| Approx. 510 cm (16 <sup>1</sup> / <sub>2</sub> feet) | 15.0 ms |

□: Recommended placement

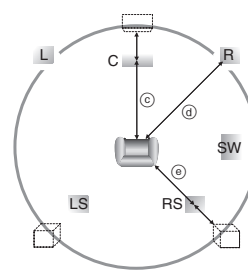

## Language code list

|                       |                   |                        |                      |                      |                  |
|-----------------------|-------------------|------------------------|----------------------|----------------------|------------------|
| Abkhazian: 6566       | Chinese: 9072     | Hausa: 7265            | Lithuanian: 7684     | Romanian: 8279       | Telugu: 8469     |
| Afar: 6565            | Corsican: 6779    | Hebrew: 7387           | Macedonian: 7775     | Russian: 8285        | Thai: 8472       |
| Afrikaans: 6570       | Croatian: 7282    | Hindi: 7273            | Malagasy: 7771       | Samoan: 8377         | Tibetan: 6679    |
| Albanian: 8381        | Czech: 6783       | Hungarian: 7285        | Malay: 7783          | Sanskrit: 8365       | Tigrinya: 8473   |
| Ameharic: 6577        | Danish: 6865      | Icelandic: 7383        | Malayalam: 7776      | Scots Gaelic: 7168   | Tonga: 8479      |
| Arabic: 6582          | Dutch: 7876       | Indonesian: 7378       | Maltese: 7784        | Serbian: 8382        | Turkish: 8482    |
| Armenian: 7289        | English: 6978     | Interlingua: 7365      | Maori: 7773          | Serbo-Croatian: 8372 | Turkmen: 8475    |
| Assamese: 6583        | Esperanto: 6979   | Irish: 7165            | Marathi: 7782        | Shona: 8378          | Twi: 8487        |
| Aymara: 6589          | Estonian: 6984    | Italian: 7384          | Moldavian: 7779      | Sindhi: 8368         | Ukrainian: 8575  |
| Azerbaijani: 6590     | Faroese: 7079     | Japanese: 7465         | Mongolian: 7778      | Singhalese: 8373     | Urdu: 8582       |
| Bashkir: 6665         | Fiji: 7074        | Javanese: 7487         | Nauru: 7865          | Slovak: 8375         | Uzbek: 8590      |
| Basque: 6985          | Finnish: 7073     | Kannada: 7578          | Nepali: 7869         | Slovenian: 8376      | Vietnamese: 8673 |
| Bengali, Bangla: 6678 | French: 7082      | Kashmiri: 7583         | Norwegian: 7879      | Somali: 8379         | Volapük: 8679    |
| Bhutanian: 6890       | Frisian: 7089     | Kazakh: 7575           | Oriya: 7982          | Spanish: 6983        | Welsh: 6789      |
| Bihari: 6672          | Galician: 7176    | Kirghiz: 7589          | Pashto, Pushto: 8083 | Sundanese: 8385      | Wolof: 8779      |
| Breton: 6682          | Georgian: 7565    | Korean: 7579           | Persian: 7065        | Swahili: 8387        | Xhosa: 8872      |
| Bulgarian: 6671       | German: 6869      | Kurdish: 7585          | Polish: 8076         | Swedish: 8386        | Yiddish: 7473    |
| Burmese: 7789         | Greek: 6976       | Laotian: 7679          | Portuguese: 8084     | Tagalog: 8476        | Yoruba: 8979     |
| Byelorussian: 6669    | Greenlandic: 7576 | Latin: 7665            | Punjabi: 8065        | Tajik: 8471          | Zulu: 9085       |
| Cambodian: 7577       | Guarani: 7178     | Latvian, Lettish: 7686 | Quechua: 8185        | Tamil: 8465          |                  |
| Catalan: 6765         | Gujarati: 7185    | Lingala: 7678          | Rhaeto-Romance: 8277 | Tatar: 8484          |                  |

| On the unit's display   |  | Page        |
|---|--|-------------|
| H□□, F□□<br>("□□" stands for a number.)                         | <ul style="list-style-type: none"> <li>An error has occurred. The number following "H" or "F" depends on the status of the unit. Check the items in the "Error messages" section and the "Troubleshooting guide". If the service number still does not disappear after the check, follow the Reset procedure described below.<br/><b>Reset procedure: ("The unit is on but cannot be operated." → 69)</b></li> <li>If the service numbers fail to clear, note the service numbers and contact a qualified service person.</li> </ul> | –           |
| SET □ ("□" stands for a number.)                                | <ul style="list-style-type: none"> <li>The remote control and main unit are using different codes. Change the code on the remote control.</li> </ul>   | 21          |
| HARD ERR  | <ul style="list-style-type: none"> <li>If there is no change after turning the unit on and off, consult the dealer where the unit was purchased.</li> </ul>  | –           |
| NoREAD  | <ul style="list-style-type: none"> <li>The disc is dirty or badly scratched. The unit cannot record, play, or edit.</li> <li>You have used a lens cleaner and it has finished. Press [▲, OPEN/CLOSE] to eject the disc.</li> </ul>   | 6, 10<br>24 |
| PLEASE WAIT<br>("PLEASE" and "WAIT" are alternately displayed.) | <ul style="list-style-type: none"> <li>Displayed when the unit is started. This is not a malfunction.</li> <li>The unit is carrying out its recovery process. You cannot operate the unit while "PLEASE WAIT" is displayed.</li> </ul>   | –           |
| PROG FULL<br>("PROG" and "FULL" are alternately displayed.)     | <ul style="list-style-type: none"> <li>There are already 16 scheduled recording programs. Delete unnecessary scheduled recording programs.</li> </ul>  | 31          |
| UNSUPPORT<br>("UNSUP" and "PORT" are alternately displayed.)    | <ul style="list-style-type: none"> <li>You have inserted a disc the unit cannot play or record on.</li> </ul>  | 7           |
| UNFORMAT<br>("UNFOR" and "MAT" are alternately displayed.)      | <ul style="list-style-type: none"> <li>You have inserted a new DVD-RW/+R/+R DL/+RW or a DVD-RAM/DVD-RW (DVD-Video format) recorded on other equipment.</li> </ul>  | 61          |
| F74   | <ul style="list-style-type: none"> <li>The HDMI connection could not be authenticated due to a transfer malfunction.</li> </ul>  | –           |
| F75   | <ul style="list-style-type: none"> <li>The HDMI connection could not be authenticated due to a internal data malfunction.</li> </ul>   | –           |
| U59   | <ul style="list-style-type: none"> <li>The unit is very warm.<br/>The unit switches to standby for safety reasons. Wait for about 30 minutes until the message disappears. Select a position with good ventilation when installing the unit. Do not block the cooling fan on the rear of the unit.</li> </ul>  | –           |
| U61   | <ul style="list-style-type: none"> <li>There was a power failure or the AC plug was disconnected while the unit was on. The unit is carrying out its recovery process. This process restores the unit to normal operation. The unit is not broken. Wait until the message disappears.</li> </ul>   | –           |
| U71   | <ul style="list-style-type: none"> <li>The connected equipment is not HDMI compatible.</li> </ul>  | –           |
| U72<br>U73  | <ul style="list-style-type: none"> <li>The HDMI connection acts unusually.                             <ul style="list-style-type: none"> <li>The connected equipment is not HDMI compatible.</li> <li>The HDMI cable is too long.</li> <li>The HDMI cable is damaged.</li> </ul> </li> </ul>  | –           |
| U88   | <ul style="list-style-type: none"> <li>There was something unusual detected with the disc while recording, playing or transferring (copying), there was a power failure or the AC plug was disconnected while the unit was on. The unit is carrying out its recovery process. This process restores the unit to normal operation. The unit is not broken. Wait until the message disappears.</li> </ul>  | 69          |
| U99   | <ul style="list-style-type: none"> <li>The unit fails to operate properly. Press [⏻/I, POWER] on the main unit to switch the unit to standby. Now press [⏻/I, POWER] on the main unit again to turn the unit on.</li> </ul>  | –           |

| On the TV   |   | Page            |
|---|---|-----------------|
| Cannot finish recording completely.   | <ul style="list-style-type: none"> <li>The program was copy-protected.</li> <li>The disc may be full.</li> <li>There are already 99 recorded titles (+R +R DL +RW 49 recorded titles).</li> </ul>   | –               |
| Cannot play.  | <ul style="list-style-type: none"> <li>You inserted an incompatible disc (Discs recorded in PAL video, etc.).</li> </ul>  | –               |
| Cannot record on the disc.  | <ul style="list-style-type: none"> <li>The disc may be dirty or scratched.</li> </ul>   | 10              |
| Unable to format.   |   |                 |
| Please check the disc.  |   |                 |
| Cannot record. Disc is full.  | <ul style="list-style-type: none"> <li>Create space by erasing any unwanted titles. RAM -RW(V) +RW<br/>[Even if you erase recorded content from the DVD-R or +R, there is no increase in disc space. Available recording space on a DVD-RW (DVD-Video format) or +RW increases when the last recorded title is deleted. (The recording space may increase slightly when other titles are deleted.)]</li> <li>Use a new disc.</li> </ul> | 41, 59,<br>60   |
| Cannot record. The number of titles has exceeded the maximum limit.   |   | –               |
| Error has occurred. Please press ENTER.   | <ul style="list-style-type: none"> <li>Press [ENTER] to start recovery process. You cannot operate the unit while it is recovering ("SELF CHECK" appears on the unit's display).</li> </ul>   | –               |
| No disc   | <ul style="list-style-type: none"> <li>You haven't inserted a disc. Correctly insert a disc that the unit can play.</li> <li>The disc is upside down. If it is a single-sided disc, insert it so the label is facing up.</li> </ul>   | 6, 10, 24<br>24 |
| No folders.   | <ul style="list-style-type: none"> <li>There is no compatible folder in this unit.</li> </ul>   | 8               |
| No SD Card<br>No valid SD card.   | <ul style="list-style-type: none"> <li>The card is not inserted. If this message is displayed with a compatible card already inserted, turn off the unit, remove and then re-insert the card.</li> <li>The card inserted is not compatible or the card format does not match.</li> </ul>  | 11<br>8         |
| No VHS cassette   | <ul style="list-style-type: none"> <li>A video cassette is not inserted when recording programs. Insert a video cassette with an accidental erasure prevention tab.</li> </ul>  | 11, 24          |
| Now recording on DVD. To watch the VHS playback, connect a TV to DVD/VHS COMMON OUT terminal at the back of the unit, and select the appropriate input on the TV. | <ul style="list-style-type: none"> <li>The VHS plays back while recording on DVD. You can watch the VHS playback by connect to the DVD/VHS COMMON terminals.</li> </ul>   | 15              |
| Please change the disc.   | <ul style="list-style-type: none"> <li>There may be a problem with the disc. Press [▲, OPEN/CLOSE] on the main unit to remove it and check it for scratches or dirt. (The unit turns off automatically after you open the tray.)</li> </ul>   | 10              |
| Please set the clock.   | <ul style="list-style-type: none"> <li>The clock is not set when recording programs or setting the scheduled recording. Set the clock.</li> </ul>   | 19, 22          |
| The VHS cassette is protected.  | <ul style="list-style-type: none"> <li>A video cassette without the accidental erasure prevention tab is inserted when recording programs. Use a video cassette with an accidental erasure prevention tab.</li> </ul>   | 11              |
| This is a non-recordable disc.  | <ul style="list-style-type: none"> <li>The unit cannot record on the disc you inserted. Insert a DVD-RAM or unfinalized DVD-R, DVD-R DL, DVD-RW (DVD-Video format), +R, +R DL or +RW.</li> </ul>  | –               |
| This disc is not formatted properly.  | <ul style="list-style-type: none"> <li>You inserted an unformatted DVD-RAM, DVD-RW, +R, +R DL or +RW. Format the disc with the unit.</li> </ul>   | 61              |
| ⊘   | <ul style="list-style-type: none"> <li>The operation is prohibited by the unit, disc or cassette.</li> </ul>  | 32              |

# Frequently asked questions

## Set up

|  |   | Page    |
|--|---|---------|
| <b>What equipment is necessary to play multi channel surround sound?</b>   | <ul style="list-style-type: none"> <li>You cannot playback multi-channel sound on this unit without other equipment. You must connect this unit with a HDMI cable or an optical digital cable to an amplifier with a built-in (Dolby Digital or DTS) decoder.</li> <li>An amplifier supporting CPPM and the HDMI standard version 1.1 must be connected to this unit to play multi-channel audio on a DVD-Audio.</li> </ul> | 16<br>– |
| <b>Can the headphones and speakers be directly connected to the unit?</b>  | <ul style="list-style-type: none"> <li>You cannot directly connect to the unit. Connect through the amplifier etc.</li> </ul>   | 16      |
| <b>The television has S VIDEO IN terminal, COMPONENT VIDEO IN terminals and HDMI IN terminal. Which should I connect with?</b> | <ul style="list-style-type: none"> <li>The output picture quality increases in the following order.                             <ul style="list-style-type: none"> <li>VIDEO IN terminal, S VIDEO IN terminal, COMPONENT VIDEO IN terminals and HDMI IN terminal. However the unit will take longer to startup when this it is connected with the HDMI IN terminal.</li> </ul> </li> </ul>                                  | –       |
| <b>Is my TV progressive output compatible?</b>   | <ul style="list-style-type: none"> <li>All Panasonic TVs that have 480p input terminals are compatible. Consult the manufacturer if you have another brand of TV.</li> </ul>  | –       |

## Disc

|   |  | Page              |
|---|--|-------------------|
| <b>Can I play DVD-Video, DVD-Audio and Video CDs bought in another country?</b>                     | <ul style="list-style-type: none"> <li>You can play them if the video standard is NTSC.</li> <li>However, you cannot play DVD-Video if its region number does not include "1" or "ALL".</li> </ul>   | –<br>Cover        |
| <b>Can a DVD-Video that does not have a region number be played?</b>                                | <ul style="list-style-type: none"> <li>The DVD-Video region number indicates the disc conforms to a standard. You cannot play discs that do not have a region number.</li> </ul>   | –                 |
| <b>Please tell me about DVD-R, DVD-R DL, DVD-RW, +R, +R DL and +RW compatibility with the unit.</b> | <ul style="list-style-type: none"> <li>The unit records and plays DVD-R, DVD-R DL, DVD-RW (DVD-Video format), +R, +R DL and +RW, and plays DVD-RW (DVD Video Recording format).</li> <li>The unit also records and plays high speed recording compatible discs.</li> <li>After recording but before finalizing +R, +R DL discs                             <ul style="list-style-type: none"> <li>You may not be able to play and record discs on this unit after recording them on other Panasonic products or other manufacturer's equipment.</li> <li>You may not be able to play and record discs on other equipment after recording them on this unit. After finalizing the disc, however, you will be able to play it on any DVD-Video compatible player.</li> </ul> </li> </ul> | 6, 7<br>6<br>–    |
| <b>Please tell me about CD-R and CD-RW compatibility with the unit.</b>                             | <ul style="list-style-type: none"> <li>This unit plays CD-R/CD-RW discs which have been recorded in one of the following standards: CD-DA, Video CD, MP3 and still pictures (JPEG/TIFF). Close the session or finalize the disc after recording. This unit can recognize up to 99 folders (groups) and 999 files (tracks) on a disc with MP3 or still pictures (JPEG/TIFF).</li> <li>You cannot write to a CD-R or CD-RW with the unit.</li> </ul>   | 7, 34,<br>35<br>7 |

## Recording

|   |  | Page     |
|---|--|----------|
| <b>Can I record from a commercially purchased video cassette or DVD?</b>  | <ul style="list-style-type: none"> <li>Most commercially sold video cassettes and DVD are copy protected; therefore, recording is usually not possible.</li> </ul>   | –        |
| <b>Can DVD-R, DVD-R DL, DVD-RW (DVD-Video format), +R, +R DL and +RW recorded on the unit be played on other equipment?</b> | <ul style="list-style-type: none"> <li>You can play on compatible equipment such as DVD players after finalizing the disc on this unit. It is not necessary to finalize +RW. However, depending on the condition of the recording, the quality of the disc and capabilities of the DVD player, play may not be possible. To enable play on other DVD players, please use "Create DVD Top Menu" in the DVD management menu.</li> </ul>  | 61       |
| <b>Can I record digital audio signals using the unit?</b>   | <ul style="list-style-type: none"> <li>You cannot record digital signals. The digital audio terminals on the unit are for output only. (The audio recorded from a digital video camcorder using the DV automatic recording function, for example, is recorded digitally.)</li> </ul>   | –        |
| <b>Can a digital audio signal from the unit be recorded to other equipment?</b>   | <ul style="list-style-type: none"> <li>You can record if using the PCM signal. When recording DVD, change the "Digital Audio Output" settings to the following from the Setup menu.                             <ul style="list-style-type: none"> <li>PCM Down Conversion "On"</li> <li>Dolby Digital "PCM"</li> <li>DTS "PCM"</li> </ul>                             However, only                             <ul style="list-style-type: none"> <li>As long as digital recording from the disc is permitted.</li> <li>As long as the recording equipment is compatible with 48 kHz of sampling frequency.</li> </ul> </li> <li>You cannot record MP3 signals.</li> </ul> | 64<br>–  |
| <b>Can I switch to SAP during recording?</b>  | <ul style="list-style-type: none"> <li>With DVD-RAM, you can, and the audio recorded also changes. Just press [AUDIO].</li> <li>With DVD-R, DVD-R DL, DVD-RW (DVD-Video format), +R, +R DL, +RW you cannot. Change before recording with "Multi-channel TV sound (MTS)" in the Setup menu.</li> </ul>  | 27<br>64 |

# Troubleshooting guide

Before requesting service, make the following checks. If you are in doubt about some of the check points, or if the remedies indicated in the chart do not solve the problem, refer to the "Customer Services Directory" on page 77 if you reside in the U.S.A. In other areas, consult your dealer.

## The following do not indicate a problem with the unit:

- Regular disc rotating sound.
- Poor reception due to atmospheric condition.
- Image disturbance during search.
- Periodic interruptions to reception due to satellite broadcasting breaks.
- Operations do not work due to a poor-quality disc. (Try again using a Panasonic disc.)
- The unit freezes due to the activation of one of its safety devices. (Press and hold [⏻/I, POWER] on the main unit for 10 seconds.)

| <b>Power</b>                                  |   | <b>Page</b> |
|---|---|-------------|
| <b>No power</b>                               | • Insert the AC power supply cord securely into a known active AC outlet.   | 14          |
| <b>The unit switches to the standby mode.</b> | <ul style="list-style-type: none"> <li>• This is a power saving feature. Change "Off Timer" in the "Setup" menu, if you would prefer.</li> <li>• One of the unit's safety devices is activated. Press [⏻/I, POWER] on the main unit to turn the unit on.</li> </ul> | 63<br>–     |

| <b>Displays</b>   |  | <b>Page</b>           |
|---|--|-----------------------|
| <b>The display is dim.</b>  | • Change "FL Display" in the Setup menu.   | 65                    |
| <b>"12:00A" is flashing on the unit's display.</b>  | • Set the clock.   | 19, 22                |
| <b>The recording time display, the transfer (copying) process display and the displayed recording time of MP3 are different from the actual time.</b> | <ul style="list-style-type: none"> <li>• Times shown may disagree with actual times.</li> <li>• In DVD-R, DVD-R DL, +R or +R DL the remaining capacity does not increase even if titles are deleted.</li> <li>• Available recording space on a DVD-RW (DVD-Video format) or +RW increases when the last recorded title is deleted. (The recording space may increase slightly when other titles are deleted.)</li> <li>• If you repeat recording or editing about 200 times or more, the remaining capacity of the DVD-R, DVD-R DL, +R or +R DL is reduced and then recording or editing may be disabled. (For the second layer on DVD-R DL and +R DL, this happens after about 60 times.)</li> <li>• The time during fast forward and rewind, or the process during transfer (copy) may not be displayed accurately.</li> </ul> | –<br>–<br>–<br>–<br>– |
| <b>Compared to the actual recorded time, the elapsed time displayed is less.</b>  | •  |                       |

| <b>Operation</b> | <b>Page</b> |
|------------------|-------------|
|------------------|-------------|

| Picture  |  | Page    |
|--|--|---------|
| TV reception worsens after connecting the unit.  | <ul style="list-style-type: none"> <li>This can occur because the signals are being divided between the unit and other equipment. It can be solved by using a signal booster, available from audio-visual suppliers.</li> </ul>  | –       |
| The images from the unit do not appear on the TV.  | <ul style="list-style-type: none"> <li>Make sure that the TV is connected to the VIDEO OUT terminal, S VIDEO OUT terminal, COMPONENT VIDEO OUT terminals or HDMI AV OUT terminal on the unit.</li> </ul>   | 14–17   |
| Picture is distorted.  | <ul style="list-style-type: none"> <li>Make sure that the TV's input setting (e.g., VIDEO 1) is correct.</li> </ul>  | –       |
|  | <ul style="list-style-type: none"> <li>The TV isn't compatible with progressive signals. Press and hold [■] and [▶ DVD] on the main unit at the same time for about 5 seconds. The setting will change to interlace.</li> </ul>  | –       |
|  | <ul style="list-style-type: none"> <li>When connecting with a component video cable to a television that is incompatible with progressive video, check if there is also an HDMI cable connected to an amplifier, etc. If so, turn the power off to the device connected with an HDMI cable, and set the "HDMI Video Output" to "Off" in the Setup menu.</li> </ul> | –       |
|  | <ul style="list-style-type: none"> <li>To output video from a device connected with an HDMI cable, set "HDMI Video Output" to "On" in the Setup menu.</li> </ul>   | –       |
|  | <ul style="list-style-type: none"> <li>Picture may not be seen when more than 4 devices are connected with HDMI cables. Reduce the number of connected devices.</li> </ul>   | –       |
| Status messages do not appear.   | <ul style="list-style-type: none"> <li>Select "Automatic" in "Status Messages" in the Setup menu.</li> </ul>   | 65      |
| The blue background does not appear.   | <ul style="list-style-type: none"> <li>Select "On" in "Blue Background" in the Setup menu.</li> </ul>  | 65      |
| The 4:3 aspect ratio picture expands left and right.   | <ul style="list-style-type: none"> <li>Use the TV to change the aspect. If your TV does not have that function, set "Progressive" in the Video menu to "Off".</li> </ul>   | 40      |
|  | <ul style="list-style-type: none"> <li>If you connect an HDMI cable, set "HDMI Output Display Aspect" in the Setup menu to "Normal".</li> </ul>  | 65      |
|  | <ul style="list-style-type: none"> <li>Check the settings for "TV Type", "4:3 TV Settings for DVD-Video", or "4:3 TV Settings for DVD-RAM" in the Setup menu.</li> </ul>   | 65      |
| There is a lot of after-image when playing video.  | <ul style="list-style-type: none"> <li>Set "DNR" in the Video menu to "Off".</li> </ul>  | 40      |
| When playing DVD-Video using progressive output, one part of the picture momentarily appears to be doubled up. | <ul style="list-style-type: none"> <li>Set "Progressive" in the Video menu to "Off". This problem is caused by the editing method or material used on DVD-Video, but should be corrected if you use interlace output.</li> </ul>   | 40      |
|  | <ul style="list-style-type: none"> <li>When you use the HDMI AV OUT terminal for video output, follow the steps below for setting.                             <ol style="list-style-type: none"> <li>Connect this unit to the TV with any cable except the HDMI cable</li> <li>Set "HDMI Video Output" in the Setup menu to "Off"</li> </ol> </li> </ul>          | –<br>65 |
| There is no apparent change in picture quality when adjusted with the Video menu in the on-screen menus.       | <ul style="list-style-type: none"> <li>The effect cannot be seen with certain types of video.</li> </ul>   | –       |

| Sound  |   | Page  |
|--|---|---|
| No sound.<br>Low volume.<br>Distorted sound.<br>Cannot hear the desired audio type.  | <ul style="list-style-type: none"> <li>Check the connections and "Digital Audio Output" settings. Check the input mode on the amplifier if you have connected one.</li> </ul>   | 16, 64  |
|  | <ul style="list-style-type: none"> <li>Press [AUDIO] to select the audio.</li> </ul>  | 27, 33  |
|  | <ul style="list-style-type: none"> <li>Set "V. Surround Sound" in the Audio menu to "Off" in the following cases.                             <ul style="list-style-type: none"> <li>When using discs that do not have surround sound effects such as Karaoke discs.</li> <li>When playing MTS broadcast titles.</li> </ul> </li> </ul> | 40  |
|  | <ul style="list-style-type: none"> <li>This unit cannot playback multi-channel discs that prevent down-mixing unless the unit is connected with a HDMI cable to an amplifier supporting CPPM and the HDMI standard version 1.1. Refer to the disc jacket for more information. <b>DVD-A</b></li> </ul>                                  | –   |
|  | <ul style="list-style-type: none"> <li>The sound effects will not work when the bitstream signal is output from the HDMI AV OUT terminal or the OPTICAL DIGITAL AUDIO OUT terminal.</li> </ul>  | –   |
|  | <ul style="list-style-type: none"> <li>Audio may not be heard when more than 4 devices are connected with HDMI cables. Reduce the number of connected devices.</li> </ul>   | –   |
|  | <ul style="list-style-type: none"> <li>When the DIGITAL AUDIO OUT (Optical) terminal is used for audio output and the unit is connected to the television with a HDMI cable, set "HDMI Audio Output" to "Off" in the setup menu.</li> </ul>   | 65  |
|  | <ul style="list-style-type: none"> <li>If the sound is distorted when the unit is connected to an amplifier with the HDMI cable, adjust the settings in "HDMI Connection Speakers Setting" in the Setup menu to match the connection.</li> </ul>  | 65  |
|  | <ul style="list-style-type: none"> <li>Depending on the connected equipment, the sound may be distorted if this unit is connected with a HDMI cable.</li> </ul>   | –   |
|  | Cannot switch audio.  | <ul style="list-style-type: none"> <li>You cannot change the audio type when a DVD-R, a DVD-R DL, a DVD-RW (DVD-Video format), a +R, a +R DL or a +RW is in the disc tray.</li> </ul> |
| <ul style="list-style-type: none"> <li>You cannot change the audio type when playing a DVD-R, a DVD-R DL, a DVD-RW (DVD-Video format), a +R, a +R DL or a +RW. (You can select "Main" or "Secondary Audio Program (SAP)" in "Multi-channel TV sound (MTS)" in the Setup menu before recording.)</li> </ul> |   | 64  |
| <ul style="list-style-type: none"> <li>You have used a digital connection. Set "Dolby Digital" to "PCM" or connect using audio cables (analog connection).</li> </ul>  |   | 16, 64  |
| <ul style="list-style-type: none"> <li>There are discs whose audio cannot be changed because of how the disc was created.</li> </ul>   |   | –   |

| Recording, Scheduled recording, Transfer (Copying), External input   | Page  |
|--|---|
| <b>Cannot record.</b>  | • You haven't inserted a disc or the disc you inserted cannot be recorded on. Insert a disc the unit can record onto. 6   |
|  | • The disc is unformatted. Format the disc. <b>RAM -RW(V) +R +R DL +RW</b> 61   |
|  | • The write-protect tab on the cartridge is set to "PROTECT" or the disc is protected with "DVD Management". 60   |
|  | • Some programs have limitations on the number of times they can be recorded (CPRM). 6, 76  |
|  | • The disc is full or nearly full. Delete unneeded titles or use another disc. 41, 59   |
|  | • You cannot record on finalized DVD-R, DVD-R DL, DVD-RW (DVD-Video format), +R, +R DL or DVD-RW (DVD Video Recording format) discs. 61   |
|  | • If you repeatedly insert discs or turn the unit on and off about 50 times or more, the recording or editing of DVD-R, DVD-R DL, DVD-RW (DVD-Video format), +R, +R DL, +RW may be disabled. -  |
|  | • A DVD-R, DVD-R DL, DVD-RW (DVD-Video format), +R, +R DL, +RW recorded on the unit may not be recordable on other Panasonic DVD recorders. -   |
|  | • The material you are trying to record is copy-protected. -  |
|  | • Scheduled recording will not be activated when in editing or transfer (copy). Scheduled recording will begin after the editing/transfer (copy) is finished. -   |
| <b>Scheduled recording does not work properly.</b>   | • The scheduled recording program is incorrect or different scheduled recording times overlap. Correct the program. 31  |
|  | • The clock is not correct. Set the clock. 19, 22   |
| • Scheduled recording will not be activated during formatting, transfer (copying) and other such operations which should not be interrupted when they are being carried out. - |   |
| <b>Scheduled recording does not stop even when [■, STOP] is pressed.</b>   | • If you start recording immediately after turning on the unit while "Quick Start" is set to "On", you cannot then stop recording for a few seconds. 63   |
| <b>The scheduled recording program remains even after recording finishes.</b>  | • The scheduled recording program remains if set to daily or weekly. 31   |
| <b>A part or whole of a recorded title has been lost.</b>  | • If the power shuts down or the plug is disconnected from the household AC outlet while recording or editing, the program may be lost or the disc may become unusable. We cannot offer any guarantee regarding lost titles or discs. You will have to format the disc ( <b>RAM -RW(V) +RW</b> ) or use a new disc. - |
| <b>Cannot transfer (copy) VHS to DVD.</b>  | • The write-protect tab on the cartridge is set to "PROTECT" or the disc is protected with "DVD Management". 60   |
|  | • Some video tapes on the market (including rental videos) are copy-protected to prevent illegal reproductions. Copy-protected video tapes cannot be properly recorded. -   |
|  | • You cannot use the transfer (copying) function when the FUNCTIONS window, the Scheduled Recording List screen, etc. are displayed. -  |
| <b>Cannot transfer (copy) DVD to VHS.</b>  | • A video cassette without the accidental erasure prevention tab is inserted. Use a video cassette with an accidental erasure prevention tab. 11  |
|  | • Some DVDs on the market (including rental DVD) are copy-protected to prevent illegal reproductions. Copy-protected DVDs cannot be properly recorded. -  |
|  | • You cannot use the transfer (copying) function when the FUNCTIONS window, the Scheduled Recording List screen, etc. are displayed. -  |
| <b>The sound level after editing is not equal on DVD and on VHS.</b>   | • The sound level on DVD and VHS may not match depending on the disc. When the sound level in a particular part of the sound source is soft or loud, the sound may be recorded loudly or softly on a video tape. -  |
| <b>Stripe-shaped black noise is recorded.</b>  | • The device in playback is interfering with the TV because the device is too close to the TV. Move the device away from the TV. -  |
| <b>Cannot record video or sound from the external device.</b>  | • The external device is not correctly connected. 57  |
|  | • The proper external input channel (IN1, IN2 or DV) is not selected. 57  |
| <b>The DV automatic recording function does not work.</b>  | • If images cannot be recorded or if the recording is aborted, check the connections and DV equipment settings. 57  |
|  | • You cannot start recording until the images from the DV equipment appear on the television. -   |
|  | • Recording may not be performed as desired if the time codes on the tape in the DV equipment are not successive. -   |
|  | • Depending on the equipment, the DV automatic recording may not operate properly. -  |
|  | • You can only record audio/video images on a DV tape. -  |

| Play   |   | Page         |
|--|---|--------------|
| <b>Play fails to start even when [▶, PLAY] is pressed.</b><br><b>Play starts but then stops immediately.</b> | ●Insert the disc correctly with the label facing up.  | 24           |
|  | ●The disc is dirty.   | 10           |
|  | ●You tried to play a blank disc or a disc that is unplayable on the unit.   | 7            |
|  | ●You tried to play a +RW that needs to be finalized on the equipment used for recording.  | –            |
|  | ●When recording to DVD-RAM using EP (8H) mode, play may not be possible on DVD players that are compatible with DVD-RAM. In this case use EP (6H) mode.                                   | 64           |
| <b>Audio and video momentarily pause.</b>  | ●You cannot play discs during DV automatic recording.   | –            |
|  | ●This occurs between playlist chapters.<br>●This occurs as scenes change during Quick View.   | 32           |
| <b>DVD-Video is not played.</b>  | ●Some DVD-Video cannot be played when you change the ratings level.   | 63           |
| <b>Alternative sound track and subtitles cannot be selected.</b>   | ●This occurs between playlist chapters.   | –            |
|  | ●This occurs as scenes change during Quick View.  | 32           |
| <b>No subtitles.</b>   | ●Multiple languages are not recorded on the disc.   | –            |
|  | ●You may have to use the disc's own menus to select languages.  | 32           |
|  | ●When progressive output is on, closed captions cannot be displayed.<br>●Subtitles are not recorded on the disc.<br>●Set "Subtitle" in the Disc menu to "On".                             | –<br>–<br>39 |
| <b>Angle cannot be changed.</b>  | ●This function depends on software availability. Angles can only be changed during scenes where different angles are recorded.  | –            |
| <b>You have forgotten your ratings password.</b>   | ●With the tray open, keep pressing [●, REC] and [▶] on the main unit simultaneously for about 5 or more seconds.  | –            |
| <b>Quick View does not work.</b>   | ●This does not work when audio is other than Dolby Digital.   | –            |
|  | ●This does not work when recording is in XP or FR mode.   | –            |
| <b>The resume play function does not work.</b>   | ●Memorized positions are canceled when the unit is turned off or when the tray is opened. The memorized position on the playlist is also canceled when the playlist and title are edited. | –            |

| Edit  |  | Page |
|---|--|------|
| <b>Cannot format.</b>   | ●The disc is dirty. Wipe with a damp cloth and then wipe dry.  | 10   |
|   | ●You tried formatting a disc that is not compatible with the unit.   | 7    |
| <b>Cannot create chapters.</b><br><b>Cannot mark the start point or the end point during "Shorten Title" operation.</b> | ●The unit writes the chapter division information to the disc when you turn it off or remove the disc. The information is not written if there is an interruption in the power before this.    | –    |
|   | ●These operations are not possible with still pictures.  | –    |
|   | ●You cannot set points if they are too close to each other. You cannot set an end point before a start point.  | –    |
| <b>Cannot delete chapters.</b>  | ●When the chapter is too short to delete, use "Combine Chapters" to make the chapter longer.   | 43   |
| <b>The available recording time doesn't increase even after deleting recordings on the disc.</b>                        | ●Available recording space on the DVD-R, the DVD-R DL, the +R or the +R DL does not increase even after deleting previously recorded titles.   | –    |
|   | ●Available recording space on a DVD-RW (DVD-Video format) or +RW increases when the last recorded title is deleted. (The recording space may increase slightly when other titles are deleted.) | –    |
| <b>Cannot create a playlist.</b>  | ●You cannot select all the chapters in a title at once as the source of playlist edition if the title also includes still pictures. Select them individually.                                  | –    |



### Still pictures

|   |  | Page                   |
|---|--|------------------------|
| Cannot display Direct Navigator screen.                             | <ul style="list-style-type: none"> <li>This screen cannot be displayed during recording or copy.</li> </ul>  | -                      |
| Cannot edit or format a card.                                       | <ul style="list-style-type: none"> <li>Release the card's protection setting. (With some cards, the "Write Protection Off" message sometimes appears on the screen even when protection has been set.)</li> </ul>  | 60                     |
| The contents of the card cannot be read.                            | <ul style="list-style-type: none"> <li>The card format is not compatible with the unit. (The contents on the card may be damaged.) Format using FAT 12 or FAT 16 with other equipment or format the card with this unit.</li> <li>The card contains a folder structure and/or file extensions that are not compatible with this unit.</li> <li>Turn off and then turn on the unit again.</li> <li>SD memory cards from 8 MB to 2 GB can be used with this unit.</li> </ul> | 8, 36,<br>60<br>8<br>- |
| Copying, deleting and setting protection takes a long time.         | <ul style="list-style-type: none"> <li>When there are a lot of folders and files, it may sometimes take a few hours.</li> <li>When repeating copying or deleting, it may sometimes take a long time. Format the disc or card.</li> </ul>   | -<br>60                |
| Scheduled recording began in the middle of editing a still picture. | <ul style="list-style-type: none"> <li>If it comes to the time scheduled for recording, the recording may start even though you are editing.</li> </ul>  | -                      |

### VHS Picture

|                                    |  | Page   |
|------------------------------------|--|--------|
| OSD messages do not appear.        | <ul style="list-style-type: none"> <li>Go to Setup and select "Automatic" in "Status Messages". Press [STATUS] to show the on-screen messages constantly.</li> </ul>   | 38, 65 |
| The blue back appears during play. | <ul style="list-style-type: none"> <li>You are playing a blank or poor quality part of the tape.</li> <li>You can damage the unit if you play dirty or damaged tapes and this can cause the blue back to appear. Consult your dealer.</li> </ul> | -<br>- |

### VHS Sound

|   |   | Page    |
|---|---|---------|
| Cannot hear the desired audio type.       | <ul style="list-style-type: none"> <li>Press [AUDIO] to select the audio.</li> </ul>                        | 33      |
| There is noise when playing a video tape. | <ul style="list-style-type: none"> <li>Adjust the tracking.</li> <li>The tape is old or damaged.</li> </ul> | 38<br>- |

### VHS Play

|                               |   | Page   |
|-------------------------------|---|--------|
| Cannot play.                  | <ul style="list-style-type: none"> <li>Tapes recorded under a TV system other than NTSC (PAL, SECAM, etc.) cannot be played.</li> </ul> | -      |
| The playback screen flickers. | <ul style="list-style-type: none"> <li>The video head is dirty.</li> <li>The tape is too old or damaged.</li> </ul>                     | -<br>- |

### VHS Recording, scheduled recording

|   |   | Page     |
|---|---|----------|
| "  " flashes when I try to start recording. Cannot record. | <ul style="list-style-type: none"> <li>A video cassette is not inserted. Insert a video cassette with an accidental erasure prevention tab.</li> <li>The erasure prevention tab has been removed. Cover the hole with adhesive tape.</li> </ul> | 24<br>11 |
| Cannot record TV program.   | <ul style="list-style-type: none"> <li>The desired channel is not selected. Select the desired TV program.</li> </ul>   | -        |

# Product Service

1. **Damage requiring service** — The unit should be serviced by qualified service personnel if:
  - (a) The AC power supply cord or AC adaptor has been damaged; or
  - (b) Objects or liquids have gotten into the unit; or
  - (c) The unit has been exposed to rain; or
  - (d) The unit does not operate normally or exhibits a marked change in performance; or
  - (e) The unit has been dropped or the cabinet damaged.
2. **Servicing** — Do not attempt to service the unit beyond that described in these operating instructions. Refer all other servicing to authorized servicing personnel.
3. **Replacement parts** — When parts need replacing ensure the servicer uses parts specified by the manufacturer or parts that have the same characteristics as the original parts. Unauthorized substitutes may result in fire, electric shock, or other hazards.
4. **Safety check** — After repairs or service, ask the servicer to perform safety checks to confirm that the unit is in proper working condition.

## Product information

For product information or assistance with product operation:

Refer to "Customer Services Directory" on page (→ 77).

The model number and serial number of this product can be found on either the back or the bottom of the unit. Please note them in the space provided below and keep for future reference.

MODEL NUMBER \_\_\_\_\_

SERIAL NUMBER \_\_\_\_\_

### User memo:

DATE OF PURCHASE \_\_\_\_\_

DEALER NAME \_\_\_\_\_

DEALER ADDRESS \_\_\_\_\_

TELEPHONE NUMBER \_\_\_\_\_

|                                   |                 |
|-----------------------------------|-----------------|
| <b>Power supply:</b>              | AC 120 V, 60 Hz |
| <b>Power consumption:</b>         | Approx. 29 W    |
| <b>Standby mode:</b> (Display ON) | Approx. 3.2 W   |
| (Display OFF)                     | Approx. 3.0 W   |

#### Recordable discs:

|          |  |
|----------|--|
| DVD-RAM: | Ver. 2.0<br>Ver. 2.1/3X-SPEED DVD-RAM Revision 1.0<br>Ver. 2.2/5X-SPEED DVD-RAM Revision 2.0   |
| DVD-R:   | for General Ver. 2.0<br>for General Ver. 2.0/4X-SPEED DVD-R Revision 1.0<br>for General Ver. 2.x/8X-SPEED DVD-R Revision 3.0<br>for General Ver. 2.x/16X-SPEED DVD-R Revision 6.0<br>for DL Ver. 3.0<br>for DL Ver. 3.x/4X-SPEED DVD-R for DL Revision 1.0 |
| DVD-RW:  | Ver. 1.1<br>Ver. 1.1/2X-SPEED DVD-RW Revision 1.0<br>Ver. 1.2/4X-SPEED DVD-RW Revision 2.0   |
| +R:      | Ver. 1.0<br>Ver. 1.1<br>Ver. 1.2<br>for DL Ver. 1.0  |
| +RW:     | Ver. 1.1<br>Ver. 1.2/4X-SPEED  |

#### Recording system:

|                        |                            |
|------------------------|----------------------------|
| DVD-RAM:               | DVD Video Recording format |
| DVD-R:                 | DVD-Video format           |
| DVD-R DL (Dual Layer): | DVD-Video format           |
| DVD-RW:                | DVD-Video format           |
| +R                     |                            |
| +R DL (Double Layer)   |                            |
| +RW                    |                            |

#### Recording time:

|      |   |
|------|---|
| Max. | 8 hours (using 4.7 GB disc)                       |
| XP:  | Approx. 1 hour    SP: Approx. 2 hours             |
| LP:  | Approx. 4 hours    EP: Approx. 6 hours or 8 hours |

#### Playable discs:

|  |  |
|--|--|
| DVD-RAM:   | DVD Video Recording format                   |
| DVD-R:   | DVD-Video format                             |
| DVD-R DL (Dual Layer):                           | DVD-Video format                             |
| DVD-RW:  | DVD-Video format, DVD Video Recording format |
| +R   |  |
| +R DL (Double Layer)                             |  |
| +RW  |  |
| DVD-Video, DVD-Audio, CD-Audio (CD-DA), Video CD |  |
| CD-R/CD-RW (CD-DA, Video CD, MP3, JPEG)          |  |

#### Optical pick-up:

System with 1 lens, 2 integration units  
(662 nm wavelength for DVDs, 780 nm wavelength for CDs)

#### LASER Specification:

|                       |  |
|-----------------------|--|
| Class 1 LASER Product |  |
| Wave Length:          | 780 nm (CDs)<br>662 nm (DVDs)                                |
| Laser Power:          | No hazardous radiation is emitted with the safety protection |

#### Television system:

|                                 |   |
|---------------------------------|---|
| <b>TV system:</b>               | NTSC system, 525 lines, 60 fields         |
| <b>Antenna reception input:</b> |   |
| TV Channel:                     | VHF: 2 ch to 13 ch<br>UHF: 14 ch to 69 ch |
| CATV Channel:                   | 5A & A-5 ch to EEE ch                     |

#### Quick Start for Recording (Quick Start : ON)

1 Sec. Quick Start for Recording on DVD-RAM\*  
\* From the power off state, recording on DVD-RAM starts about 1 second after first pressing the Power button and then sequentially pressing the REC button (Quick Start Mode).

#### Video system:

|                                    |                    |  |
|------------------------------------|--------------------|--|
| <b>Recording system:</b> (for DVD) | MPEG2 (Hybrid VBR) |  |
| <b>Input:</b>                      | LINE (pin jack)×2  | 1.0 Vp-p; 75 Ω                           |
|                                    | S connector×2      | Y: 1.0 Vp-p; 75 Ω<br>C: 0.286 Vp-p; 75 Ω |

#### Output: (for DVD PRIORITY)

|                   |  |
|-------------------|--|
| LINE (pin jack)×2 | 1.0 Vp-p; 75 Ω                           |
| S connector×2     | Y: 1.0 Vp-p; 75 Ω<br>C: 0.286 Vp-p; 75 Ω |

#### Component video output: (for DVD PRIORITY)

|                         |   |
|-------------------------|---|
| Y, PB, PR×1 (480i/480p) | Y: 1.0 Vp-p; 75 Ω<br>PB: 0.7 Vp-p; 75 Ω<br>PR: 0.7 Vp-p; 75 Ω |
|-------------------------|---|

#### Audio system:

##### Recording system: (for DVD)

Dolby Digital (2 ch)  
Linear PCM (XP mode 2 ch)

##### Analog Input:

LINE (pin jack)×2  
Reference input: 309 mVrms  
FS: 2 Vrms (1 kHz, 0 dB)  
Input impedance: 22 kΩ

##### Analog Output: (for DVD PRIORITY)

LINE (pin jack)×2  
Reference output: 309 mVrms  
FS: 2 Vrms (1 kHz, 0 dB)  
Output impedance: 1 kΩ  
(Load impedance: 10 kΩ)

##### Number of channels: (for DVD)

Recording: 2 channels  
Playback: 2 channels

##### Number of track: (for VHS)

HiFi: 2 track  
Normal: 1 track

##### Digital Output: (for DVD PRIORITY)

Digital audio optical output connector×1  
(PCM, Dolby Digital, DTS)

#### VHS:

##### Recording format:

VHS Video Cassette System Standard with FM audio  
**Heads:** 4 Helical Scan Heads for Video  
2 Helical Scan Heads for FM audio  
1 Fixed Head for Normal audio

##### Tape speed/Recording time:

SP: 33.35 mm/s, 120 min (with T-120 cassette)  
EP: 11.12 mm/s, 360 min (with T-120 cassette)

##### FF/REW time:

FF/REW: Approx. 60 s (with T-120 cassette)  
Jet REW: Approx. 43 s (with T-120 cassette)

#### HDMI Output:

19 pin typeA×1  
HDMI Ver. 1.2a (EDID Ver. 1.3)

#### DV Input:

IEEE 1394 Standard, 4 Pin×1

#### SD Card Slot:

##### Still picture (JPEG, TIFF):

SD Memory Card Slot 1 pc

##### Compatible media:

SD Memory Card\*, MultiMediaCard  
\* includes miniSD™ Cards (A miniSD™ adaptor needs to be inserted)

##### Format:

FAT12, FAT16

##### Image File Format:

JPEG conforming DCF (Design rule for Camera File system), TIFF (Uncompressed RGB chunky), DPOF Compatible  
Sub sampling 4:2:2 or 4:2:0

##### Number of pixels:

Between 34×34 pixels and 6144×4096 pixels

##### Thawing time:

Approx. 3 sec (6M pixels, JPEG)

#### Regional Code:

# 1

#### Clock unit:

Quartz-controlled 12-hour digital display

#### Operating temperature range:

5 °C to 40 °C (41 °F to 104 °F)

#### Operating humidity range:

10% to 80% RH (no condensation)

#### Dimensions:

Approx. 430 mm (W)×84 mm (H)×343 mm (D)  
[Approx. 16<sup>5</sup>/<sub>16</sub>" (W)×3<sup>5</sup>/<sub>16</sub>" (H)×13<sup>7</sup>/<sub>8</sub>" (D)]

#### Mass:

Approx. 5.4 kg (Approx. 11.9 lbs)

#### Note

Specifications are subject to change without notice.  
Mass and dimensions shown are approximate.  
• Useable capacity will be less (SD Memory Card).

## Bitstream

This is a signal compressed and converted into digital form. It is converted back to a multi-channel audio signal, e.g., 5.1-channel, by a decoder.

## CPPM (Content Protection for Pre-recorded Media)

A copy protection system used for DVD-Audio files. This unit supports CPPM.

## CPRM (Content Protection for Recordable Media)

CPRM is technology used to protect broadcasts that are allowed to be recorded only once. Such broadcasts can be recorded only with CPRM compatible recorders and discs.

## Decoder

A decoder restores the coded audio signals on DVDs to normal. This is called decoding.

## Down-mixing

This is the process of remixing the multi-channel audio found on some discs into two channels. It is useful when you want to listen to the 5.1-channel audio recorded on DVDs through your TV's speakers. Some discs prohibit down-mixing. If this is the case, this unit can only output the front two channels.

Tracks that do not allow down-mixing will not play correctly on this unit except when connecting with an HDMI cable to an amplifier that meets HDMI Ver. 1.1 standards and is CPPM compatible.

## DPOF (Digital Print Order Format)

DPOF is the standard printing format for still picture data taken by a digital camera, etc. It is used for automatic printing at a photo developing store or on your home printer.

## Dynamic range

Dynamic range is the difference between the lowest level of sound that can be heard above the noise of the equipment and the highest level of sound before distortion occurs. Dynamic range compression means reducing the gap between the loudest and softest sounds. This means you can hear dialog clearly at low volume.

## Film and Video

DVD-Videos are recorded using either film or video. The unit can determine which type has been used, then uses the most suitable method of progressive output.

- Film is 24 or 30 frames per second, with motion picture film generally being 24 frames per second.
- Video is 60 fields per second (2 fields making up 1 frame).

## Finalize

A process that makes play of a recorded CD-R, CD-RW, DVD-R, etc. possible on equipment that can play such media. You can finalize DVD-R, DVD-R DL, DVD-RW (DVD-Video format), +R and +R DL on the unit. After finalizing, the disc becomes play-only and you can no longer record or edit. However, finalized DVD-RW can be formatted to become recordable.

## Folder

This is a place on the memory card where groups of data are stored together. In the case of this unit, it refers to the place where still pictures (JPEG, TIFF) are stored.

## Formatting

Formatting is the process of making media such as DVD-RAM recordable on recording equipment. You can format DVD-RAM and DVD-RW (only as DVD-Video format) or +RW and SD memory card on this unit. Formatting irrevocably erases all contents.

## Frame and field

Frame refers to the single images that constitute the video you see on your TV. Each frame consists of 2 fields.

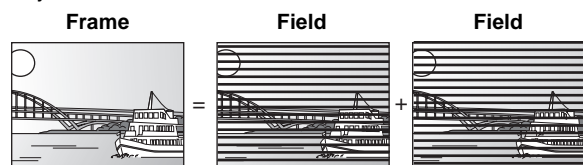

- A frame still shows 2 fields, so there may be some blurring between them, but picture quality is generally better.
- A field still shows less picture information so it may be rougher, but there is no blurring.

## HDMI (High-Definition Multimedia Interface)

HDMI is a next-generation digital interface for consumer electronic products. Unlike conventional connections, it transmits uncompressed digital video and audio signals on a single cable. This unit supports high-definition video output (720p, 1080i) from HDMI AV OUT terminals. To enjoy high-definition video a high definition compatible television is required.

## JPEG (Joint Photographic Experts Group)

This is a system used for compressing/decoding color still pictures. If you select JPEG as the storage system on digital cameras, etc., the data will be compressed to 1/10–1/100 of its original size. The benefit of JPEG is less deterioration in picture quality considering the degree of compression.

## MP3 (MPEG Audio Layer 3)

An audio compression method that compresses audio to approximately one-tenth of its size without any considerable loss of audio quality. You can play MP3s you have recorded onto CD-R and CD-RW.

## Pan & Scan/Letterbox

In general, DVD-Video are produced with the intention that they will be viewed on a widescreen TV (16:9 aspect ratio), so images often don't fit regular TVs (4:3 aspect ratio). 2 styles of picture, "Pan & Scan" and "Letterbox", deal with this problem.

Pan & Scan: The sides are cut off so the picture fills the screen.

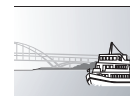

Letterbox: Black bands appear at the top and bottom of the picture so the picture itself appears in an aspect ratio of 16:9.

## Playback control (PBC)

If a Video CD has playback control, you can select scenes and information with menus displayed on the screen. (The unit is compatible with version 2.0 and 1.1.)

## Progressive/Interlace

NTSC, the video signal standard, has 480 interlaced (i) scan lines, whereas progressive scanning uses twice the number of scan lines. This is called 480p.

Using progressive output, you can enjoy the high-resolution video recorded on media such as DVD-Video.

Your TV must be compatible to enjoy progressive video.

## Protection

You can prevent accidental erasure by setting writing protection or erasure protection.

## Sampling frequency

Sampling is the process of converting the heights of sound wave (analog signal) samples taken at set periods into digits (digital encoding). Sampling frequency is the number of samples taken per second, so larger numbers mean more faithful reproduction of the original sound.

## Thumbnail

This refers to a miniature representation of a picture used to display multiple pictures in the form of a list.

## TIFF (Tag Image File Format)

This is a system used for compressing/decoding color still pictures, a common format for storing high quality images on digital cameras and other devices.

# Limited Warranty

Panasonic Consumer Electronics Company,  
Division of Panasonic Corporation of North America  
One Panasonic Way Secaucus, New Jersey 07094

Panasonic Puerto Rico, Inc.  
Ave. 65 de Infantería, Km. 9.5  
San Gabriel Industrial Park, Carolina, Puerto Rico 00985

## Panasonic DVD Recorder Limited Warranty

### Limited Warranty Coverage

If your product does not work properly because of a defect in materials or workmanship, Panasonic Consumer Electronics Company or Panasonic Puerto Rico, Inc. (collectively referred to as "the warrantor") will, for the length of the period indicated on the chart below, which starts with the date of original purchase ("warranty period"), at its option either (a) repair your product with new or refurbished parts, or (b) replace it with a new or a refurbished product. The decision to repair or replace will be made by the warrantor.

| Product or Part Name  | Parts         | Labor          |
|---|---------------|----------------|
| DVD Recorder  | One (1) Year  | One (1) Year   |
| Rechargeable Batteries, DVD-RAM Disc (in exchange for defective item) | Ten (10) Days | Not Applicable |

During the "Labor" warranty period there will be no charge for labor. During the "Parts" warranty period, there will be no charge for parts. You must carry-in or mail-in your product during the warranty period. If non-rechargeable batteries are included, they are not warranted. This warranty only applies to products purchased and serviced in the United States or Puerto Rico. This warranty is extended only to the original purchaser of a new product which was not sold "as is". A purchase receipt or other proof of the original purchase date is required for warranty service.

### Carry-In or Mail-In Service

For Carry-In or Mail-In Service in the United States call 1-800-211-PANA (7262) or visit Panasonic Web Site: <http://www.panasonic.com>  
For assistance in Puerto Rico call Panasonic Puerto Rico, Inc. (787)-750-4300 or fax (787)-768-2910.

### Limited Warranty Limits And Exclusions

This warranty ONLY COVERS failures due to defects in materials or workmanship, and DOES NOT COVER normal wear and tear or cosmetic damage. The warranty ALSO DOES NOT COVER damages which occurred in shipment, or failures which are caused by products not supplied by the warrantor, or failures which result from accidents, misuse, abuse, neglect, mishandling, misapplication, alteration, faulty installation, set-up adjustments, misadjustment of consumer controls, improper maintenance, power line surge, lightning damage, modification, or commercial use (such as in a hotel, office, restaurant, or other business), rental use of the product, service by anyone other than a Factory Servicenter or other Authorized Servicer, or damage that is attributable to acts of God.

**THERE ARE NO EXPRESS WARRANTIES EXCEPT AS LISTED UNDER "LIMITED WARRANTY COVERAGE". THE WARRANTOR IS NOT LIABLE FOR INCIDENTAL OR CONSEQUENTIAL DAMAGES RESULTING FROM THE USE OF THIS PRODUCT, OR ARISING OUT OF ANY BREACH OF THIS WARRANTY.** (As examples, this excludes damages for lost time, travel to and from the servicer, loss of media or images, data or other recorded content. The items listed are not exclusive, but are for illustration only.) **ALL EXPRESS AND IMPLIED WARRANTIES, INCLUDING THE WARRANTY OF MERCHANTABILITY, ARE LIMITED TO THE PERIOD OF THE LIMITED WARRANTY.**

Some states do not allow the exclusion or limitation of incidental or consequential damages, or limitations on how long an implied warranty lasts, so the exclusions may not apply to you.

This warranty gives you specific legal rights and you may also have other rights which vary from state to state. If a problem with this product develops during or after the warranty period, you may contact your dealer or Servicenter. If the problem is not handled to your satisfaction, then write to the warrantor's Consumer Affairs Department at the addresses listed for the warrantor.

**PARTS AND SERVICE WHICH ARE NOT COVERED BY THIS LIMITED WARRANTY ARE YOUR RESPONSIBILITY.**

## Customer Services Directory

Obtain Product Information and Operating Assistance; locate your nearest Dealer or Servicenter; purchase Parts and Accessories; or make Customer Service and Literature requests by visiting our Web Site at:

<http://www.panasonic.com/consumersupport>

or, contact us via the web at:

<http://www.panasonic.com/contactinfo>

You may also contact us directly at:

1-800-211-PANA (7262),  
Monday-Friday 9 am-9 pm; Saturday-Sunday 10 am-7 pm, EST.

For hearing or speech impaired TTY users, TTY : 1-877-833-8855

## Accessory Purchases

Purchase Parts, Accessories and Instruction Books online for all Panasonic Products by visiting our Web Site at:

<http://www.pasc.panasonic.com>

or, send your request by E-mail to:

[npcparts@us.panasonic.com](mailto:npcparts@us.panasonic.com)

You may also contact us directly at:

1-800-332-5368 (Phone) 1-800-237-9080 (Fax Only) (Monday – Friday 9 am to 8 pm, EST.)

Panasonic Services Company

20421 84th Avenue South, Kent, WA 98032

(We Accept Visa, MasterCard, Discover Card, American Express, and Personal Checks)

For hearing or speech impaired TTY users, TTY : 1-866-605-1277

## Service in Puerto Rico

Panasonic Puerto Rico, Inc.

Ave. 65 de Infantería, Km. 9.5, San Gabriel Industrial Park, Carolina, Puerto Rico 00985

Phone (787)750-4300, Fax (787)768-2910

F1003



# Instalación básica

- Antes de hacer la conexión, apague todos los equipos y lea los manuales de instrucciones apropiados.
- El equipo periférico y los cables opcionales se venden por separado a menos que se indique lo contrario.

## Para su referencia

- Las conexiones del equipo descritas son ejemplos.
- El equipo periférico y los cables opcionales se venden por separado a menos que se indique lo contrario.

## ■ Cuando la unidad no vaya a utilizarse durante mucho tiempo

Para ahorrar energía, desenchufe la unidad de la toma de CA. Esta unidad consume una pequeña cantidad de energía aunque se encuentre apagada (**8 W aproximadamente**).

## ■ No conecte la unidad mediante una videogradora

Los sistemas de protección de los derechos de autor afectarán las señales de video enviadas mediante una videogradora y la imagen no se mostrará bien en el televisor.

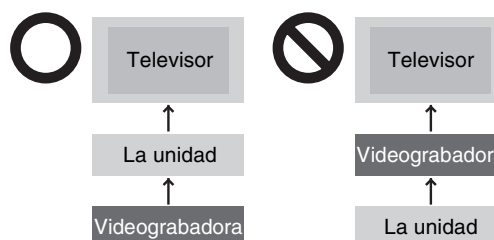

## Conexión con un televisor

### ■ Conexión (con cable de audio/vídeo)

Conecte por orden numérico de **1** a **4**.

- Después de esta conexión, ajuste el canal de salida RF "OFF" (→ 80), y luego pulse el botón TV/VIDEO del mando a distancia del televisor para seleccionar el modo de entrada AV al terminal del televisor conectado. Puede mirar un vídeo desde esta unidad en su televisor.

### ■ Conexión (sin cable de audio/vídeo)

No necesita conectar "**3**".

La unidad envía una señal al televisor a través de un cable coaxial de 75 Ω en el canal 3 o 4. Es posible ver una imagen de vídeo en su televisor de la misma manera que la que ve en las emisiones televisivas.

- Después de esta conexión, ajuste el canal de salida RF "CH3" o "CH4" (→ 80).

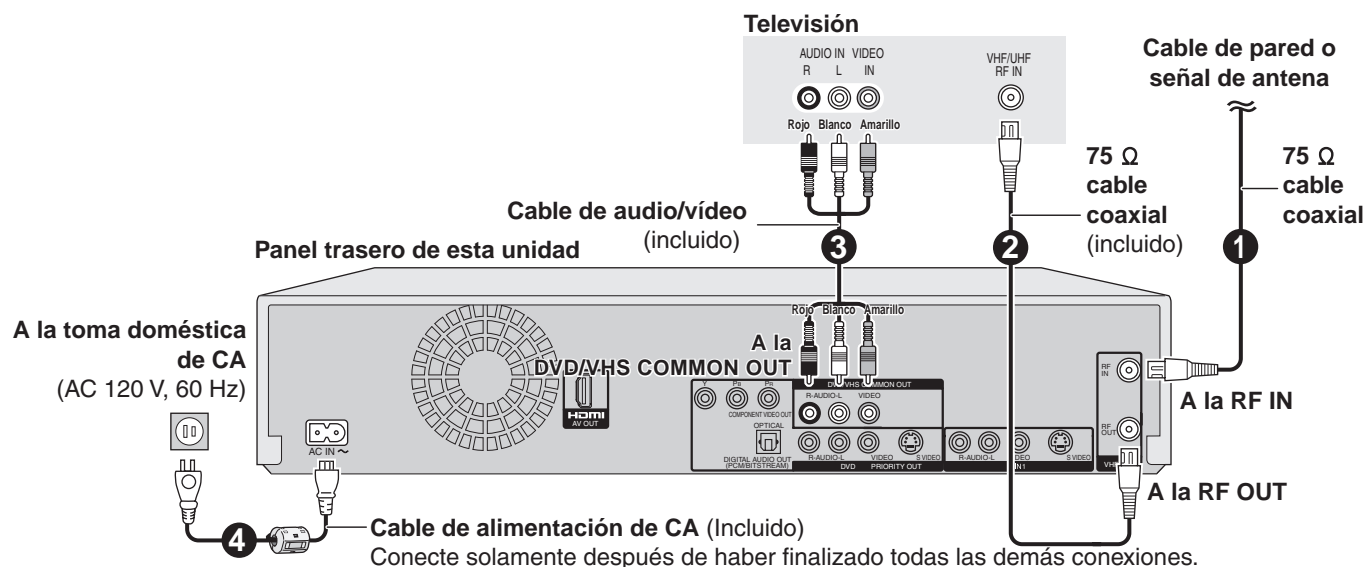

## Salida DVD y salida DVD/VHS

La unidad tiene terminales de salida DVD/VHS COMMON y los de salida DVD PRIORITY.

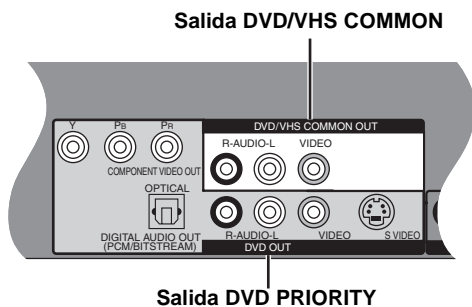

### DVD/VHS COMMON OUT

- Para los terminales de salida DVD/VHS COMMON, pueden lograrse sea las señales DVD sea las VHS.

### DVD PRIORITY OUT

- Salvo mientras que graba o va haciendo una grabación programada, con el terminal de salida DVD PRIORITY puede también reproducir una cinta en el DVD.

## Para gozar de una más alta calidad de la imagen

### ■ Conexión al terminal S VIDEO IN

#### Terminal S VIDEO OUT

Los terminales S VIDEO OUT logran una imagen más viva que la del terminal VIDEO OUT. (El resultado real depende del televisor.) Tras terminar "Conexión con un televisor", conecte el cable S VIDEO. De costumbre puede ver una imagen desde el terminal INPUT2. Cuando quiere reproducir un VHS mientras graba en DVD, cambie al terminal INPUT1.

### ■ Conexión a los terminales COMPONENT VIDEO IN

#### Terminal COMPONENT VIDEO OUT

Estos terminales pueden usarse para el entrelazado o la salida progresiva y proporcionan una imagen más clara que la del terminal S VIDEO OUT.

Tras terminar "Conexión con un televisor", conecte el cable COMPONENT VIDEO.

De costumbre puede ver una imagen desde el terminal COMPONENT VIDEO INPUT. Cuando quiere reproducir un VHS mientras graba en DVD, cambie al terminal INPUT1.

- Conecte a los terminales del mismo color.

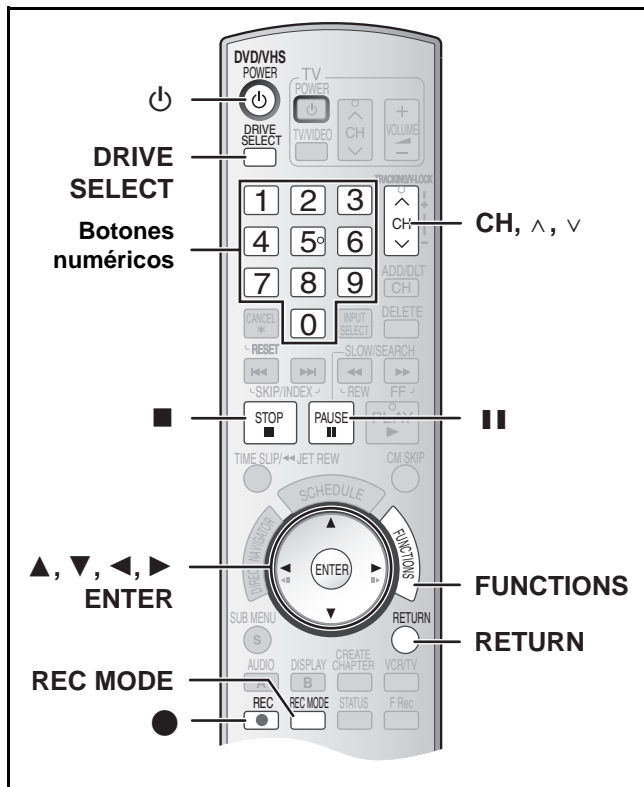

### Sintonización automática por Plug-in

#### Preparación

- Encienda el televisor y seleccione la entrada de vídeo apropiada a las conexiones de la unidad (Ejemplo: entrada AV, CH3 o CH4).
  - Si conecta la unidad a través de una caja para televisor de cable o un receptor de satélite, sintonice su PBS local para que funcione el ajuste automático del reloj.
- Si no hay ningún PBS local, ajuste el reloj manualmente.

#### 1 Pulse [⏻, DVD/VHS POWER].

#### 2 Pulse [CH, ^, v] para seleccionar un número de canal de salida RF.

#### Conexión

(sin cable de audio/vídeo):  
Seleccione "CH3" o "CH4" que visualiza la pantalla a la derecha.

#### Conexión

(con cable de audio/vídeo):  
Seleccione "OFF"

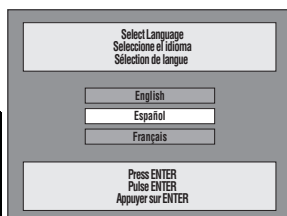

El visualizador de la unidad



#### El visualizador de la unidad

Cada vez que pulsa el botón:

CH 3 (Ajustes predeterminados) ↔ CH4 ↔ OFF

#### 3 Utilice [▲, ▼] para seleccionar el idioma y pulse [ENTER].

#### 4 Pulse [▲, ▼] para seleccionar "TV de 4:3" o "TV ancho de 16:9" y pulse [ENTER].

#### 5 Pulse [▲, ▼] para seleccionar "Encendido" o "Apagado" y pulse [ENTER].

Si activa la función "Accionamiento rápido", seleccione "Encendido".

#### Acerca de la función "Accionamiento rápido"

Si ajusta Accionamiento rápido en activado, puede iniciar a grabar al DVD-RAM alrededor de 1 segundo después de que haya pulsado [⏻, DVD/VHS POWER] para encender la unidad.

Cuando haya seleccionado "Encendido", tiene lugar lo siguiente.

- El consumo de energía en espera aumenta por el hecho de que se suministra energía a los mandos de la unidad.

#### 6 Pulse [▲, ▼] para seleccionar "Sintonizador" o "Entrada" y pulse [ENTER].

Cuando no ajusta los canales en esta unidad, seleccione "Entrada". La unidad entonces muestra la pantalla "Ajuste manual del reloj".

Ajuste manualmente el reloj.

#### 7 Pulse [ENTER] para iniciar la sintonización automática por Plug-in.

- La unidad procede con el ajuste automático del reloj. La hora aparece cuando esté terminado dicho ajuste.

#### ■ Cuando aparece la pantalla "No se ha encontrado ningún canal" o la de "Ajust. automat. del reloj no acabado"

Después de apagar la unidad, confirme lo siguiente y vuelva a configurar.

- Compruebe si el cable de antena está firmemente conectado al terminal RF IN.
  - Si no ajusta los canales en esta unidad, seleccione "Entrada" en el paso 6.
- Pantalla "Ajust. automat. del reloj no acabado."  
Pulse [ENTER] y ajuste manualmente el reloj.

#### 8 Pulse [ENTER].

#### ■ Si el reloj tiene una hora en adelante o retrasada con respecto a la hora real

Seleccione "-1" o "+1" en "Ajustar del huso horario" en el menú CONFIGURACIÓN.

### Seleccionar el tipo de televisor

Usted no tiene que cambiar el ajuste cuando está conectado a un televisor de aspecto estándar de 4:3 que no sea compatible con la salida progresiva.

#### 1 Durante la parada

Pulse [FUNCTIONS].

#### 2 Seleccione "Otras funciones" con [▲, ▼] y pulse [ENTER].

#### 3 Seleccione "CONFIGURACIÓN" con [▲, ▼] y pulse [ENTER].

#### 4 Seleccione "Pantalla TV" con [▲, ▼] y pulse [◀, ▶].

#### 5 Seleccione "Tipo TV" [▲, ▼] y pulse [ENTER].

- Aspecto 4:3/Aspecto 16:9:

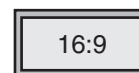

Aspecto estándar de 4:3

Televisor de aspecto panorámico 16:9

- 480p/480i:

Seleccione "480p" si el televisor es compatible con la salida progresiva.

#### 6 Utilice [▲, ▼] para seleccionar el elemento y pulse [ENTER].

#### ■ Para volver a la pantalla anterior

Pulse [RETURN].

#### ■ Para salir de la pantalla

Pulse [RETURN].



## Insertar discos

### 1 Pulse [**▲**, OPEN/CLOSE] en la unidad principal para abrir la bandeja.

- Puede insertar un disco de cartucho o sin cartucho.

### 2 Pulse [**▲**, OPEN/CLOSE] en la unidad principal para cerrar la bandeja.

- Si inserta un DVD-RAM con la lengüeta de protección contra la escritura ajustada en "PROTECT", la reproducción inicia automáticamente.

#### Nota

- Un disco de doble cara tiene que colocarse con la cara que quiere grabar/reproducir mirando hacia abajo.
- No es posible grabar continuamente desde una cara a la otra en un disco de dos caras. Tendrá que expulsar el disco y darlo la vuelta.
- Cuando utilice un DVD-RAM de 8 cm (3") o un DVD-R de 8 cm (3"), quite el disco del cartucho.

Disco sin cartucho

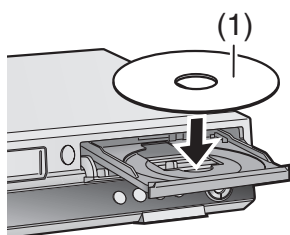

Disco en cartucho

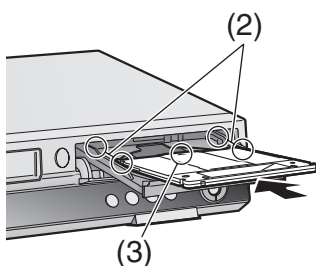

- (1) Insértelo con la cara impresa hacia arriba.  
 (2) Inserte completamente hasta que haga un ruido seco.  
 (3) Insértelo con la etiqueta arriba y la flecha hacia adentro.

## Insertar un videocasete

La superficie a través de la que puede ver el rollo de la cinta tiene que estar de cara hacia arriba, Inserte un videocasete.

- La unidad se enciende automáticamente.

#### ■ Para expulsar un videocasete

- Puede expulsar el videocasete aun cuando la unidad esté en el modo de espera. Ésta vuelve a la espera una vez que lo haya expulsado.

#### Para la unidad principal

- Pulse [**▲**, EJECT] en la unidad principal.

#### Para el mando a distancia

Pulse [DRIVE SELECT] para seleccionar el lado VHS y luego pulse y mantenga pulsado [**■**, STOP] durante 3 segundos o más.

### Antes de grabar

- **+RW** El menú del título creado se borra cuando graba en el disco. Vuelva a crear el menú del título usando "Crear menú superior DVD." en Gestión del DVD.

**Sólo la principal o SAP pueden grabarse para las emisiones MTS, cuando graba al DVD-R, DVD-R DL, DVD-RW, +R, +R DL, +RW**

Si no conecta una caja de cable Seleccione "Main" o "SAP" en "Seleccionar MTS" del menú CONFIGURACIÓN.

Si conecta una caja de cable Seleccione "Main" o "SAP" en la caja de cable.

## Procedimientos de grabación

**RAM -R -R DL -RW(V) +R +R DL +RW VHS**

**RAM -R -R DL -RW(V)**

- Puede grabar hasta 99 títulos en un disco.

**+R +R DL +RW**

- Puede grabar hasta 49 títulos en un disco.

- No es posible grabar emisiones digitales que permiten "Grabación sólo una vez" en el DVD-R, DVD-R DL, DVD-RW, +R, +R DL, +RW o discos DVD-RAM de 8 cm (3"). Utilice un CPRM compatible DVD-RAM
- La grabación se hará en el espacio vacío del disco. Los datos no se escribirán encima de otros.
- Si ya no queda espacio en el disco de grabación, será menester borrar los títulos innecesarios o utilizar un nuevo disco.

### Cuando graba en un DVD-R, DVD-R DL, DVD-RW (Formato DVD-Vídeo), +R, +R DL o +RW

- Cuando graba emisiones MTS
  - Si no conecta una caja para televisor de cable Seleccione "Main" o "SAP" en "Seleccionar MTS" en el menú CONFIGURACIÓN.
  - Si conecta una caja para televisor de cable Seleccione "Main" o "SAP" en el TV box de cable.
- La relación de aspecto de la imagen grabada será 4:3.
- **A fin de reproducir DVD-R, DVD-R DL, DVD-RW (Formato Video DVD) +R, +R DL grabado usando esta unidad en otra fuente de reproducción, antes tiene que finalizar el disco.**

#### Preparación

- Cancele la protección. **RAM**
- Seleccione la unidad que ve el canal (por ejemplo la entrada AV) en el televisor.
- Seleccione un tipo de audio que quiere grabar. (→ 82)

### 1 Pulse [**⏻**, DVD/VHS POWER] para encender la unidad.

### 2 Pulse [DRIVE SELECT] para seleccionar la unidad en la que quiere grabar (DVD o VHS).

### 3 Inserte un disco.

- Cuando usa un DVD-RAM por la primera vez con esta unidad, formateelo para garantizar una esmerada grabación.

o

**Inserte un videocasete que tenga intacta la lengüeta de protección contra el borrado accidental.**

### 4 Pulse [CH, ▲, ▼] para seleccionar el canal.

- Para seleccionar con los botones numéricos:

| Modo de antena (Ondas hertzianas) | Modo televisor de cable (Cable) |
|-----------------------------------|---------------------------------|
| Ej., "5": [0]→[5]                 | Ej., "5": [0]→[0]→[5]           |
| "15": [1]→[5]                     | "15": [0]→[1]→[5]               |
|                                   | "115": [1]→[1]→[5]              |

### 5 Pulse [REC MODE] para seleccionar el modo de grabación.

**DVD**: XP, SP, LP o EP

**VHS**: SP, EP o VP

### 6 Pulse [**●**, REC] para empezar a grabar.

- Durante la grabación no se puede cambiar el canal ni el modo de grabación. Puede cambiarlos mientras que la grabación está en pausa, pero el material se graba como un título distinto.

#### ■ Para hacer una pausa en la grabación

Pulse [**⏸**, PAUSE]. (Pulse de nuevo para reiniciar la grabación.)

- El título no se divide en títulos distintos. **DVD**
- También puede pulsar [**●**, REC] para reiniciar la grabación.

#### ■ Para detener la grabación

Pulse [**■**, STOP].

- Grabado como 1 título hasta el punto donde termina. **DVD**

**-R -R DL -RW(V) +R +R DL +RW**

La unidad tarda unos 30 segundos en completar la información para administrar la grabación después de terminar esta última.

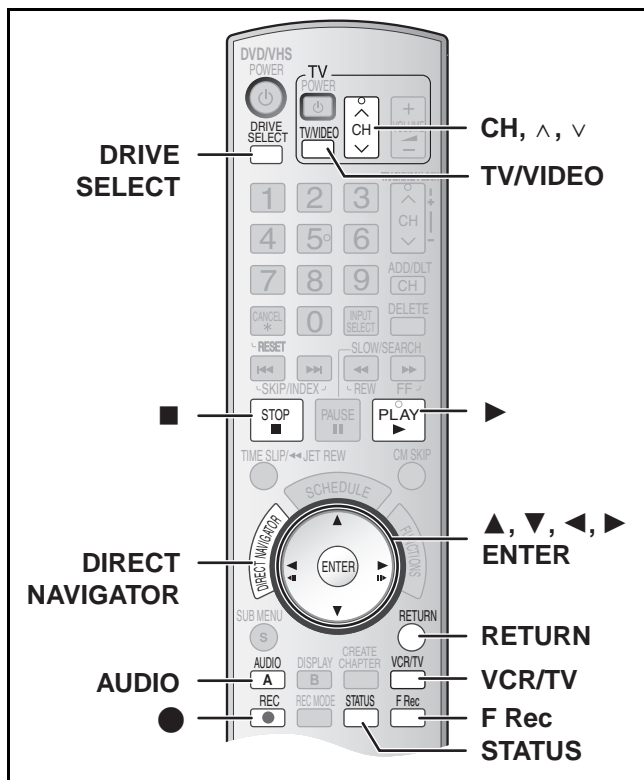

**■ Modos de grabación y tiempos de grabación aproximados (DVD)**

Dependiendo del contenido que está siendo grabado, los tiempos de grabación pueden ser inferiores a los indicados.

|                             | DVD-RAM                  |                                 | DVD-R<br>DVD-RW<br>+R, +RW<br>(4,7 GB) |
|-----------------------------|--------------------------|---------------------------------|--|
|                             | Un solo lado<br>(4,7 GB) | Dos lados*1<br>(9,4 GB)         |  |
| XP (Alta calidad)           | 1 hora                   | 2 horas                         | 1 hora                                 |
| SP (Normal)                 | 2 horas                  | 4 horas                         | 2 horas                                |
| LP (Larga duración)         | 4 horas                  | 8 horas                         | 4 horas                                |
| EP<br>(Duración extralarga) | 8 horas<br>(6 horas*2)   | 16 horas<br>(12 horas*2)        | 8 horas<br>(6 horas*2)                 |
| FR<br>(Grabación flexible)  | 8 horas<br>máximo        | 8 horas máximo<br>para una cara | 8 horas<br>máximo                      |

|                             | DVD-R DL, +R DL*3 (8,5 GB)                   |  |
|-----------------------------|--|--|
|                             | Primera capa (L0)                            | Segunda capa (L1)                            |
| XP (Alta calidad)           | 55 minutos                                   | 50 minutos                                   |
| SP (Normal)                 | 1 hora 50 minutos                            | 1 hora 40 minutos                            |
| LP (Larga duración)         | 3 horas 40 minutos                           | 3 horas 20 minutos                           |
| EP<br>(Duración extralarga) | 7 horas 25 minutos<br>(5 horas 30 minutos*2) | 6 horas 50 minutos<br>(5 horas 15 minutos*2) |
| FR<br>(Grabación flexible)  | 7 horas 25 minutos<br>máximo                 | 6 horas 50 minutos<br>máximo                 |

Esta unidad usa una grabación de velocidad variable de transferencia de bits (VBR) que varía la cantidad de datos grabados para adaptar las imágenes, así que los tiempos reales de grabación mostrados por la unidad resultarán diferentes (la diferencia será sobre todo evidente con el DVD-R DL y +R DL).

Para estar seguro, utilice un disco en el que queda bastante tiempo.

- \*1 No es posible grabar o reproducir continuamente desde una cara a la otra en un disco de dos caras.
- \*2 Cuando "Tiempo de grab. en el modo EP" ha sido ajustado a "EP - Repr. ón ampliada (6H)" en el menú CONFIGURACIÓN. La calidad del sonido es mejor cuando usa "EP - Repr. ón ampliada (6H)" que cuando usa "EP - Repr. ón ampliada (8H)".
- \*3 No es posible grabar continuamente de la primera capa a la segunda.

**Nota**

Cuando grabe en un DVD-RAM utilizando el modo EP (8H), puede que no sea posible reproducir ese disco en reproductores DVD compatibles con DVD-RAM. En este caso, utilice el modo EP (6H).

**FR (modo de grabación flexible):**

- Puede ajustar el modo FR cuando transfiera (copia) o programa grabaciones programadas.

**■ Modos de grabación (VHS)**

**Modo de grabación**

- SP: Puede grabar lo largo mostrado en la cinta.
- EP: 3 veces lo largo del modo SP.
- VP: 5 veces lo largo del modo SP.

- Para lograr una capacidad de grabación más larga, seleccione "EP" o "VP".
- Si la calidad de la imagen es importante para usted o por si desea almacenar la cinta durante un largo período, seleccione "SP".
- La unidad puede reproducir cintas grabadas en el modo LP en otro equipo ("LP" se enciende en el visualizador de la unidad).

**modo VP:**

- Una cinta grabada por la unidad en el modo VP no puede reproducirse por otras videograbadoras. Se recomienda que se la distinga entre las demás cintas escribiendo "VP" en su etiqueta, etc.

Cuando reproduce cintas grabadas con el modo VP, necesita más tiempo para que funcione el alineamiento automático y, con unas cintas, podría no funcionar en absoluto. Haga el alineamiento manualmente si fuera éste el caso.

**Nota**

No puede reproducir una grabación VP en otro equipo.

**■ Cuando se visualiza la pantalla de confirmación del formato**

**RAM -RW(V) +R +R DL +RW**

Cuando inserta un disco nuevo y uno grabado en un ordenador u otro equipo, podría aparecer una pantalla de confirmación del formato. Formatee el disco para usarlo. Sin embargo, todo el contenido grabado se va a borrar.

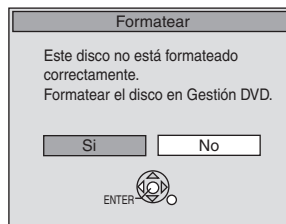

Pulse [◀, ▶] para seleccionar "Si" y pulse [ENTER].

**■ Para formatear un disco**

Son necesarios muchos pasos para formatear un disco.

**■ Cuando quita un disco grabado**

**-R -R DL -RW(V) +R +R DL**

Cuando pulsa [▲, OPEN/CLOSE] en la unidad principal mientras que va a parar:

Aparece la siguiente pantalla cuando no haya procesado el disco para reproducir en otro equipo.

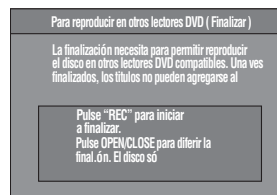

**Cuando finaliza el disco**

Pulse [●, REC].

No puede detener este proceso una vez que lo haya iniciado.

**Para especificar un tiempo para detener la grabación –Grabación de un toque**

**Mientras graba**

Pulse [●, REC] para seleccionar el tiempo de grabación.

- En la unidad principal, pulse [●, REC].

**El visualizador de la unidad**

Cada vez que pulsa el botón:

Contador (cancelar) → OFF 0:30 → OFF 1:00 → OFF 1:30  
 ↑ OFF 4:00 ← OFF 3:00 ← OFF 2:00 ←

**Seleccionar el audio para grabar**

**RAM**

Pulse [AUDIO].

Estéreo → SAP → Mono

## Reproducir DVD mientras graba VHS

Puede reproducir discos mientras graba VHS. La grabación no quedará afectada.

- Reproducción DVD (→ 84)

### Para su referencia

- No puede grabar en discos mientras graba VHS.

## Reproducir VHS mientras graba DVD

Puede reproducir cintas mientras graba DVD. La grabación no quedará afectada.

- Reproducción VHS (→ 86)

### Para su referencia

- No puede grabar en cintas mientras graba DVD.

## Ver el televisor mientras graba

### Preparación

- Conexión (sin cable de audio/vídeo)
  - Asegúrese de que el indicador TV esté encendido en el visualizador de la unidad. Por si no está encendido, pulse [VCR/TV] para encenderlo.
- Conexión (con cable de audio/vídeo)
  - Pulse [TV/VIDEO] para cambiar el modo de entrada a "TV".

**Pulse [CH, ▲, ▼] del televisor para seleccionar el canal TV deseado.**

### Para su referencia

- Puede también hacerlo si la unidad está realizando una grabación programada.
- La grabación no queda afectada.

## Reproducción mientras usted está grabando

### RAM

### Preparación

- Seleccione el lado DVD pulsando [DRIVE SELECT].

### Consejo

- El sonido no se produce durante el avance rápido.

### ■ Reproducción desde el comienzo del título mientras está grabando—Reproducción de persecución

Puede iniciar a reproducir desde el comienzo del título mientras que sigue grabándolo.

**Mientras hace una grabación normal o una programada Pulse [▶, PLAY].**

- La reproducción inicia mientras que procede la grabación.

### Para su referencia

- La reproducción no puede tener comienzo hasta que hayan pasado al menos 2 segundos desde el inicio de la grabación.

### ■ Reproducción de un título previamente grabado mientras graba—Grabación y reproducción simultáneas

Puede reproducir un título grabado anteriormente mientras que graba otro título.

**1 Mientras hace una grabación normal o una programada Pulse [DIRECT NAVIGATOR].**

**2 Pulse [▲, ▼, ◀, ▶] para seleccionar un título y pulse [ENTER].**

- La reproducción inicia mientras que procede la grabación.

### ■ Para salir de la pantalla DIRECT NAVIGATOR

Pulse [DIRECT NAVIGATOR].

### Para su referencia

- Durante la grabación y la reproducción simultáneas, no puede editar ni borrar títulos con el Direct Navigator ni listas de reproducción.
- Aunque inicie a reproducir mientras que la unidad está en espera de la grabación programada, la grabación inicia al llegar la hora establecida.

## Grabación flexible

(Grabación que cabe en el espacio restante del disco)

RAM -R -R DL -RW(V) +R +R DL +RW

La unidad computa una velocidad de grabación que permite adaptarla a la hora establecida (dentro del tiempo que queda en el disco) con la mejor calidad de la imagen.

**La utilización de "GRABACIÓN FLEX." es conveniente en este tipo de situaciones.**

- Cuando el espacio libre del disco haga que la selección del modo de grabación apropiado sea más difícil
- Cuando usted quiere grabar un programa largo con la mejor calidad de imagen posible

Ej., grabación de un programa de 90 minutos en un disco. Si selecciona el modo XP, el programa no cabrá en un disco.



Es necesario un segundo disco para 30 minutos del programa.

Si selecciona el modo SP, el programa no cabrá en un disco.



Sin embargo, quedarán unos 30 minutos de espacio libre en el disco.



Si selecciona "FLEXIBLE RECORDING", el programa cabrá perfectamente en un disco.

### Preparación

- Seleccione el lado DVD pulsando [DRIVE SELECT].
- Seleccione el canal para grabar.

### 1 Durante la parada

**Pulse [F Rec].**

### 2 Pulse [◀, ▶] para seleccionar "Hora" y "Min." y pulse [▲, ▼] para ajustar el tiempo de grabación.

- También puede poner el tiempo de grabación con los botones numéricos.
- No puede grabar durante más de 8 horas.

### 3 Cuando quiere iniciar la grabación

**Pulse [▲, ▼, ▶, ▶] para seleccionar "Empezar" y pulse [ENTER].**

- Empezará la grabación.

### Para salir de la pantalla sin grabar

Pulse [RETURN].

### Para detener la grabación al rato de empezar

Pulse [■, STOP].

### Para mostrar el tiempo restante

Pulse [STATUS].

### Para su referencia

- Durante una grabación flexible, en el visualizador de la unidad se encienden todos los indicadores del modo de grabación.
- No es posible cambiar el canal o el modo de grabación mientras que la grabación flexible está en pausa.

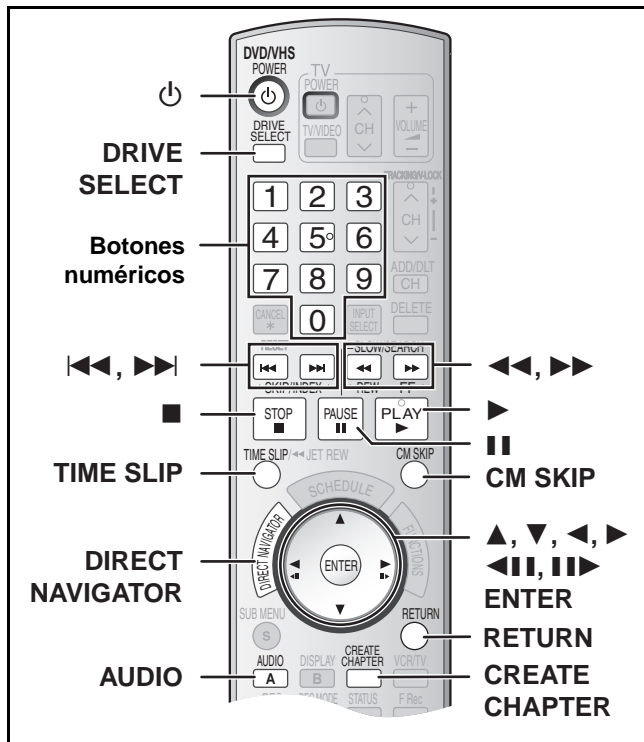

### Preparación

- Encienda el televisor y seleccione la apropiada entrada de vídeo para adaptar las conexiones a la unidad.
- Seleccione el lado DVD pulsando [DRIVE SELECT].

## Reproducir discos

RAM -R -R DL -RW(V) +R +R DL +RW DVD-A DVD-V  
-RW(VR) VCD CD

**1** Pulse [⏻, DVD/VHS POWER] para encender la unidad.

**2** Inserte un disco. (→ 81)

**3** Pulse [▶, PLAY].

- La bandeja del disco se cierra e inicia la reproducción (La unidad necesita algún tiempo para leer el disco antes de iniciar la reproducción).
- La reproducción empieza desde el título grabado más recientemente.

RAM -R -R DL -RW(V) +R +R DL +RW -RW(VR)

- La reproducción empieza desde el comienzo del disco.

DVD-A DVD-V VCD CD

### ■ Para detener la reproducción

Pulse [■, STOP].

La posición de detención se memoriza.

### Función de reanudación de la reproducción

Pulse [▶, PLAY] para reiniciar la reproducción desde esta posición.

- **VCD** Según el disco, puede no ser eficaz la función de reanudación de la reproducción.
- El punto de detención se elimina cuando:
  - Pulsa [■, STOP] muchas veces.
  - Abre la bandeja.
  - **DVD-A VCD CD** Apaga la unidad.

- Podría aparecer el salva-pantalla a la derecha cuando detiene la reproducción. Vuelva a pulsar [■, STOP] y usted puede usar el sintonizador de la unidad para ver el televisor.

Salva-pantalla



DVD-A DVD-V VCD CD

### ■ Para poner en pausa la reproducción

Pulse [⏸, PAUSE]. (Pulse de nuevo para reiniciar la reproducción.)

### ■ Cuando aparece una pantalla de menú en el televisor

#### VCD

Pulse los botones numéricos para seleccionar un elemento.

Ej.: "5": [0]→[5]

"15": [1]→[5]

#### DVD-A DVD-V

Pulse [▲, ▼, ◀, ▶] para seleccionar un elemento y pulse [ENTER].

- Algunas veces puede usar los botones numéricos para seleccionar un elemento.

#### Otros botones usados para obrar en los menús

Lea las instrucciones del disco para más detalles sobre el funcionamiento.

#### Nota

- Si aparece "⊘" en el televisor, la unidad o el disco prohíben la operación.

## Seleccionar títulos grabados para reproducir

RAM -R -R DL -RW(V) +R +R DL +RW -RW(VR)

**1** Pulse [DIRECT NAVIGATOR].

**2** Utilice [▲, ▼, ◀, ▶] para seleccionar el título que quiere ver y pulse [ENTER].

- Inicia la reproducción.
- Puede también seleccionar títulos insertando un número de 2 cifras usando los botones numéricos.

Ej.: "5": [0]→[5]

"15": [1]→[5]

- Si inserta un número más grande que el número total de títulos, se selecciona el último título.

### ■ Para eliminar la lista de títulos

Pulse [RETURN].

#### Para su referencia

- Iconos de la pantalla Direct Navigator

🔒 : Título protegido

🔒 : Protegido contra copia así que él no se pudo grabar.

x : No puede reproducir

● : En grabación

🔒 : Título con restricción "grabación de una sola vez"

## Quick View (Reproducción X1,3)

#### RAM

Puede ser aumentada la velocidad de reproducción sin distorsionar el audio.

#### Durante la reproducción

Mantenga pulsado [▶, PLAY].



### ■ Para volver a la reproducción normal

Pulse [▶, PLAY].

## Avance rápido y rebobinado — BÚSQUEDA

RAM -R -R DL -RW(V) +R +R DL +RW DVD-A DVD-V

-RW(VR) VCD CD

#### Durante la reproducción

Pulse [◀◀, SLOW/SEARCH] o [▶▶, SLOW/SEARCH].

Ej., RAM



- Hay 5 velocidades de búsqueda. Aumenta la velocidad cada vez que se pulsa. (+R +RW hasta 3 velocidades)
- Pulse [▶, PLAY] para reiniciar la reproducción.

#### Para su referencia

- El sonido sólo se produce al primer nivel de avance rápido. En el caso de DVD Audio (salvo las porciones de imágenes en movimiento), CD y MP3, él se produce en todos los niveles.
- Dependiendo del disco puede que la búsqueda resulte imposible.

## Salto

RAM -R -R DL -RW(V) +R +R DL +RW DVD-A DVD-V  
-RW(VR) VCD CD

Durante la reproducción o mientras está en pausa  
Pulse [**◀◀**, SKIP] o [**▶▶**, SKIP].

- Cada pulsación aumenta el número de saltos.

## Reproducción de cámara lenta

RAM -R -R DL -RW(V) +R +R DL +RW  
DVD-A (Partes de imagen móvil solamente) DVD-V -RW(VR) VCD

Durante la pausa

Pulse [**◀◀**, SLOW/SEARCH] o [**▶▶**, SLOW/SEARCH].

- Cuando la reproducción de cámara lenta continúa durante 5 minutos, ésta se detiene automáticamente (excluyendo DVD-A DVD-V VCD).
- Hay 5 velocidades de reproducción. Su velocidad aumenta a medida que se pulse.
- Pulse [**▶**, PLAY] para reiniciar la reproducción.
- VCD Dirección de avance ([**▶▶**, SLOW/SEARCH]) solamente.

## Vista de encuadre en encuadre

RAM -R -R DL -RW(V) +R +R DL +RW  
DVD-A (Partes de imagen móvil solamente) DVD-V -RW(VR) VCD

Durante la pausa

Pulse [**◀◀◀**] ([**◀◀**]) o [**▶▶▶**] ([**▶▶**]).

- A medida que se pulse se visualiza el encuadre siguiente o el anterior.
- Mantenga pulsado para cambiar en orden avance o retroceso.
- Pulse [**▶**, PLAY] para reiniciar la reproducción.
- VCD Dirección de avance ([**▶▶▶**], [**▶▶**]) solamente.

## Reproducción directa

RAM -R -R DL -RW(V) +R +R DL +RW DVD-A DVD-V  
-RW(VR) VCD CD

Puede reproducir desde el título, el capítulo o la pista que selecciona.

Durante la reproducción

Pulse los botones numéricos para seleccionar un elemento.

Ej.: "5": [0]→[5]      "5": [0]→[0]→[5]  
"15": [1]→[5]      "15": [0]→[1]→[5]

DVD-A

Puede especificarse un número de grupo mientras que está visualizado el salva-pantalla (→ 84).

Ej.: "5": [5]

- Esto sólo funciona durante la parada con algunos discos (el salva-pantalla se visualiza).
- **Reproducir grupos adicionales**  
En unos discos caben grupos adicionales. Si después de seleccionar un grupo aparece una pantalla de contraseña, escriba la contraseña con los botones numéricos y pulse [ENTER]. Por lo que respecta a la contraseña, se remite a la funda del disco, etc.

## Salto CM

RAM -R -R DL -RW(V) +R +R DL +RW -RW(VR)

Puede saltar aproximadamente 1 minuto con una presión.

Durante la reproducción

Pulse [**CM SKIP**].

## Crear capítulos

RAM

Durante la reproducción

Pulse [**CREATE CHAPTER**].

- Pulse [**◀◀**, SKIP] o [**▶▶**, SKIP] para saltar al comienzo de un capítulo.
- No puede activar esta función cuando está ejecutando la transferencia (copia).

## Salto del tiempo especificado — Time Slip

RAM -R -R DL -RW(V) +R +R DL +RW -RW(VR)

1 Pulse [**TIME SLIP**].

2 Pulse [**▲**, **▼**] para seleccionar el tiempo y pulse [**ENTER**].

La reproducción salta al tiempo especificado.

- Cada vez que pulsa [**▲**, **▼**] el tiempo aumenta [**▲**] o disminuye [**▼**] en intervalos de 1 minuto. (Mantenga pulsado para cambiar a intervalos de 10 minutos.)

## Cambio del audio durante la reproducción

Pulse [**AUDIO**] para seleccionar el tipo de audio.

- Según es el medio de grabación puede seleccionar el tipo de audio.

RAM -RW(VR) VCD

Estéreo → Mono L → Mono R

↑

RAM -RW(VR) [Cuando reproduce una emisión SAP grabada en un DVD-RAM, DVD-RW (Formato de grabación de vídeo DVD)]  
Principal ↔ SAP

DVD-A DVD-V

Esto le permite cambiar los elementos como el número de canal de audio y el idioma de la pista de sonido.



Ej., es el inglés el idioma seleccionado. DVD-V

VHS

Estéreo → Mono L → Mono R → Sin visualización (pista de audio normal)

↑

Nota

- Si no puede cambiar el tipo de audio cuando para la conexión sólo ha usado un cable óptico digital, ajuste "Dolby Digital" a "PCM". Alternativamente, puede conectar a un amplificador con un cable de Audio/Vídeo y cambiar la entrada en el amplificador para adaptar la conexión.



|   |                       |
|---|-----------------------|
| <b>Angle</b> .....  | <b>39</b>             |
| <b>Antenna System</b> .....                                       | <b>19</b>             |
| <b>Audio</b>  |                       |
| attributes.....   | 39                    |
| channel.....  | 39                    |
| language.....   | 64                    |
| playback.....   | 33                    |
| receiving, recording.....   | 27                    |
| <b>Auto Bilingual Choice</b> .....                                | <b>27</b>             |
| <b>Auto SP/EP mode</b> .....                                      | <b>31</b>             |
| <b>Change Thumbnail</b> .....                                     | <b>42, 46</b>         |
| <b>Channel</b>  |                       |
| adding, deleting.....   | 19                    |
| audio.....  | 39                    |
| captions.....   | 20                    |
| Set Channel Automatically.....                                    | 19                    |
| <b>Chasing playback</b> .....                                     | <b>28</b>             |
| <b>Cleaning</b>   |                       |
| disc.....   | 10                    |
| lens.....   | 3                     |
| main unit.....  | 3                     |
| video heads.....  | 11                    |
| <b>Clock Settings</b> .....                                       | <b>22</b>             |
| <b>CM Skip</b> .....  | <b>33</b>             |
| <b>Connection</b>   |                       |
| amplifier, system component.....                                  | 16                    |
| antenna.....  | 15                    |
| antenna, television.....  | 14                    |
| cable box, satellite receiver.....                                | 15                    |
| DV input terminal.....  | 57                    |
| external device.....  | 57                    |
| <b>Copy (playlist)</b> .....                                      | <b>45</b>             |
| <b>CPRM system</b> .....  | <b>6, 76</b>          |
| <b>Create chapters</b> .....                                      | <b>33, 46</b>         |
| <b>Create playlists</b> .....                                     | <b>44</b>             |
| <b>Delete</b>   |                       |
| album.....  | 48                    |
| all titles.....   | 60                    |
| chapter.....  | 43                    |
| chapter in playlist.....  | 46                    |
| playlist.....   | 45                    |
| title.....  | 41                    |
| <b>Dialog Enhancer</b> .....                                      | <b>40</b>             |
| <b>Direct Navigator</b> .....                                     | <b>32</b>             |
| <b>Divide Title</b> .....   | <b>43</b>             |
| <b>DNR</b> .....  | <b>40</b>             |
| <b>DPOF</b> .....   | <b>48, 76</b>         |
| <b>DV automatic recording</b> .....                               | <b>57</b>             |
| <b>DVD-RAM, DVD-R, DVD-R DL,<br/>DVD-RW, +R, +R DL, +RW</b> ..... | <b>6</b>              |
| <b>Enter Name</b>   |                       |
| album.....  | 48                    |
| disc.....   | 60                    |
| operation.....  | 58                    |
| playlist.....   | 45                    |
| title.....  | 30, 42                |
| <b>Finalize</b> .....   | <b>61, 76</b>         |
| <b>Flexible Recording</b> .....                                   | <b>29</b>             |
| <b>Format Disc</b> .....  | <b>61</b>             |
| <b>FR (Flexible Recording Mode)</b> .....                         | <b>26</b>             |
| <b>FUNCTIONS window</b> .....                                     | <b>40</b>             |
| <b>GUI Transfer (Copying)</b> .....                               | <b>51, 53, 55</b>     |
| <b>HDMI</b> .....   | <b>17, 65, 76</b>     |
| <b>HDAVI</b> .....  | <b>17</b>             |
| <b>Intact erasure prevention tab</b> .....                        | <b>11</b>             |
| <b>Jet Rewind</b> .....   | <b>37</b>             |
| <b>JPEG</b> .....   | <b>35, 36, 76</b>     |
| <b>Language</b>   |                       |
| audio.....  | 64                    |
| code list.....  | 66                    |
| on-screen.....  | 65                    |
| soundtrack.....   | 39                    |
| subtitle.....   | 39, 64                |
| <b>Menu</b>   |                       |
| Picture.....  | 35                    |
| MP3.....  | 34                    |
| on-screen.....  | 39                    |
| Setup.....  | 63                    |
| <b>Mode</b>   |                       |
| recording.....  | 26                    |
| Still Mode.....   | 64                    |
| <b>MP3</b> .....  | <b>34</b>             |
| <b>Noise reduction (NR)</b>                                       |                       |
| DNR.....  | 40                    |
| Line-in NR.....   | 40                    |
| <b>One Touch Transfer (Copying)</b> .....                         | <b>50, 52</b>         |
| <b>On-screen display</b> .....                                    | <b>38</b>             |
| <b>PCM Down Conversion</b> .....                                  | <b>64</b>             |
| <b>Picture</b> .....  | <b>40</b>             |
| <b>Playlist</b> .....   | <b>44</b>             |
| <b>Progressive</b> .....  | <b>16, 20, 40, 76</b> |
| <b>Properties</b>   |                       |
| playlist.....   | 45                    |
| title.....  | 41                    |
| <b>Protection</b>   |                       |
| album.....  | 48                    |
| card.....   | 60                    |
| cartridge.....  | 60                    |
| disc.....   | 60                    |
| still picture.....  | 47                    |
| title.....  | 42                    |
| <b>Quick Start</b> .....  | <b>3, 63</b>          |
| <b>Quick View</b> .....   | <b>32</b>             |
| <b>Ratings</b> .....  | <b>64</b>             |
| <b>Recording modes</b> .....                                      | <b>26</b>             |
| <b>Remaining tape time</b> .....                                  | <b>38</b>             |
| <b>Repeat play</b> .....  | <b>37, 39</b>         |
| <b>Restore default settings</b> .....                             | <b>63</b>             |
| <b>Resume play function</b> .....                                 | <b>32</b>             |
| <b>Scheduled recording</b> .....                                  | <b>30</b>             |
| <b>SD card</b> .....  | <b>8, 11</b>          |
| <b>Setup menu</b> .....   | <b>63</b>             |
| <b>Shorten Titles</b> .....                                       | <b>42</b>             |
| <b>Simultaneous recording and play</b> .....                      | <b>28</b>             |
| <b>Soundtrack</b> .....   | <b>39</b>             |
| <b>SQPB</b> .....   | <b>37</b>             |
| <b>Status messages</b> .....                                      | <b>40</b>             |
| <b>Still pictures</b>   |                       |
| copying.....  | 55                    |
| edit.....   | 47                    |
| play.....   | 35                    |
| <b>Subtitle</b> .....   | <b>39, 64</b>         |
| <b>Thumbnail</b> .....  | <b>42</b>             |
| <b>TIFF</b> .....   | <b>36, 76</b>         |
| <b>Time Slip</b> .....  | <b>33</b>             |
| <b>Tracking</b> .....   | <b>38</b>             |
| <b>Transfer</b> .....   | <b>40</b>             |
| <b>Transfer (Copying)</b> .....                                   | <b>49</b>             |
| <b>TV Type</b> .....  | <b>20</b>             |
| <b>VHS settings</b> .....   | <b>65</b>             |
| <b>VISS</b> .....   | <b>38</b>             |
| <b>VP mode</b> .....  | <b>26</b>             |
| <b>V. Surround Sound</b> .....                                    | <b>40</b>             |





## Free Manuals Download Website

<http://myh66.com>

<http://usermanuals.us>

<http://www.somanuals.com>

<http://www.4manuals.cc>

<http://www.manual-lib.com>

<http://www.404manual.com>

<http://www.luxmanual.com>

<http://aubethermostatmanual.com>

Golf course search by state

<http://golfingnear.com>

Email search by domain

<http://emailbydomain.com>

Auto manuals search

<http://auto.somanuals.com>

TV manuals search

<http://tv.somanuals.com>