

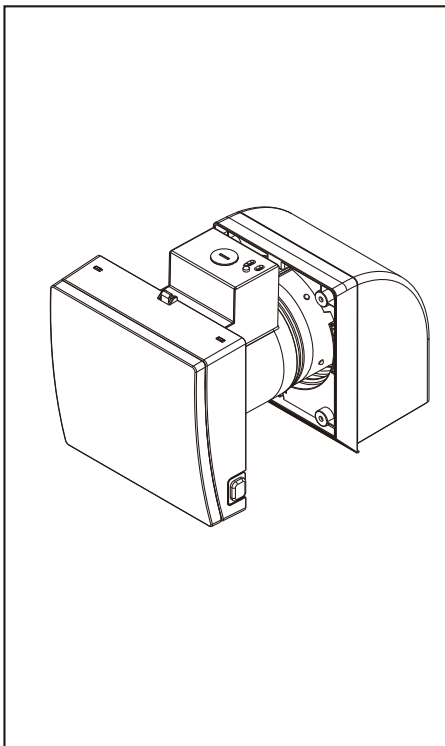

INSTALLATION INSTRUCTIONS

Ventilating Fan

Model No. FV-01WS2 FV-04WS2



Contents

GENERAL SAFETY INFORMATION	2-3
DESCRIPTION	4
UNPACKING	4
SUPPLIED ACCESSORIES	4
DIMENSIONS	5
WIRING DIAGRAM	5
INSTALLATION I (Wall thickness is 4.5"~ 6")	6-8
INSTALLATION II (Wall thickness is 6"~10")	9
MAINTENANCE (CLEANING)	10
SWITCH INDICATION	11
PRACTICAL GUIDE TO INSTALLATION	11
SPECIFICATIONS	11
PRODUCT SERVICE	BACK COVER

READ AND SAVE THESE INSTRUCTIONS

Thank you very much for having purchased our product.

Please read these instructions carefully before attempting to install, operate or service the Panasonic product. Failure to comply with instructions could result in personal injury or property damage. Please explain to users how to operate and maintain the product after installation, and this booklet should be presented to users.

Please retain this booklet for future reference.

GENERAL SAFETY INFORMATION

For Your Safety

To reduce the risk of injury, loss of life, electric shock, fire, malfunction, and damage to equipment or property, always observe the following safety precautions.

Explanation of symbol word panels

The following symbol word panels are used to classify and describe the level of hazard, injury, and property damage caused when the denotation is disregarded and improper use is performed.



Denotes a potential hazard that could result in serious injury or death.









Denotes a hazard that could result in minor injury.

The following symbols are used to classify and describe the type of instructions to be observed.

	This symbol is used to alert users to a specific operating procedure that must not be performed.
	This symbol is used to alert users to a specific operating procedure that must be followed in order to operate the unit safely.
	This symbol is used to alert users to a specific operating procedure that must not be performed.
	This symbol is used to alert users to make sure of grounding when using the equipment with the grounding terminal.





To reduce the risk of fire, electric shock or injury to persons, observe the following:

-  Use this unit only in the manner intended by the manufacturer. If you have any questions, contact the manufacturer.
-  Before servicing or cleaning unit, switch power off at service panel and lock the service disconnecting means to prevent power from being switched on accidentally. When the service disconnecting means cannot be locked, securely fasten a prominent warning device, such as a tag, to the service panel.
-  Installation work and electrical wiring must be done by qualified person(s) in accordance with all applicable codes and standards, including fire-rated construction.
-  When cutting or drilling into wall, do not damage electrical wiring and other hidden utilities.
-  Ducted fans must always be vented to the outdoors.
-  Not to be installed over a tub or shower.
-  Do not use this fan with any solid-state speed control device.













GENERAL SAFETY INFORMATION

WARNING

-  Do not disassemble the unit for reconstruction. It may cause fire or electric shock.
-  When this product is no longer being operated, please remove the product to prevent the possibility of falling.
-  This product must be properly grounded.

CAUTION

To reduce the risk of fire, electric shock or injury to persons, observe the following:

-  Do not install this ventilating fan in the window or ceiling.
-  Do not install this ventilating fan where the children can reach.
-  Do not install this ventilating fan where interior room temperature may exceed 104°F(40°C).
-  Make sure that the electric service supply voltage is AC 120V, 60Hz.
-  Follow all local electrical and safety codes, as well as the National Electrical Code (NEC) and the Occupation Safety and Health Act (OSHA).
-  Always disconnect the power source before working on or near the fan, motor, or junction box.
-  Protect the supply wiring from sharp edges, oil, grease, hot surfaces, chemicals or other objects.
-  Do not kink the supply wiring.
-  The wall must be subjected to static load more than five times the weight of the product.
-  Do not install the product with a method which is not approved in the instruction.
-  Not for use in cooking area. (Fig.A)
-  Condensation may form on the inner cover if the outdoor temperature is less than 23°F(-5°C) and the indoor temperature is above 77°F(25°C) with a 50%RH.
-  Do not install the hood where it can be buried in snow.

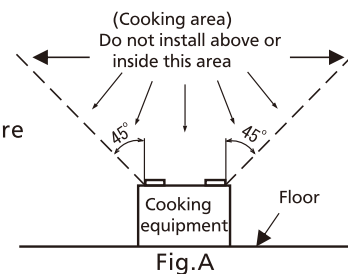





DESCRIPTION

These ventilating fan models are listed by UL under UL file No. E78414.
These ventilating fan models use a propeller fan driven by a capacitor motor.
The motor is designed to have an extended service life with reduced energy consumption.
The motor incorporates a thermal-cutoff for safety.
The inner cover will act as a damper to prevent unintended air entry.
These ventilating fans are equipped with a filter which is replaceable.

UNPACKING

Unpack and carefully remove the unit from carton.
Refer to the supplied accessories list to verify that all parts are present.

SUPPLIED ACCESSORIES

Part name	Appearance	Quantity
Screw I (M4X10)		2
Screw II (ST4.2X20)		8
Installation instructions		2
Warranty sheet		1

CAUTION

 The special-purpose or dedicated parts, such as mounting fixtures, must be used if such parts are provided.

DIMENSIONS

Main unit

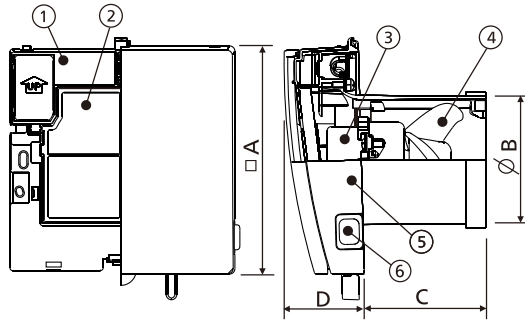

Duct unit

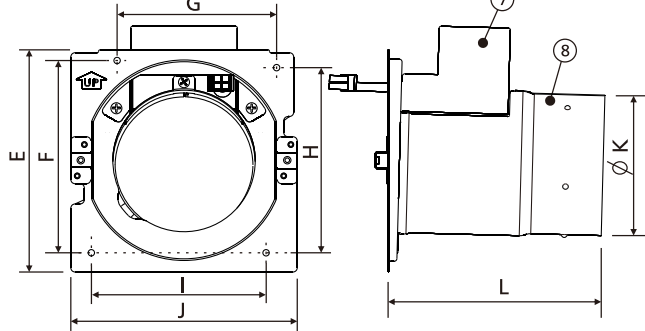

Hood unit

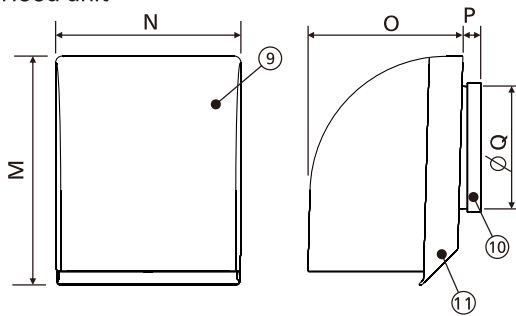

No.	Part name
①	Frame
②	Filter
③	Motor
④	Blade
⑤	Panel
⑥	Switch

No.	Part name
⑦	Junction box
⑧	Duct
⑨	Hood
⑩	Duct collar
⑪	Hood base

Unit: inches (mm)

Model	A	B	C	D	E	F	G	H	I
FV-01WS2	6 3/4 (172)	3 3/4 (95)	3 3/4 (95)	2 3/16 (55)	6 1/8 (156)	5 5/16 (135)	4 7/16 (112)	5 1/8 (130)	4 1/2 (115)
FV-04WS2	8 3/4 (222)	5 9/16 (141)	3 3/4 (95)	2 3/16 (55)	8 (203)	6 7/8 (174)	5 15/16 (151)	6 13/16 (173)	5 13/16 (148)

Model	J	K	L	M	N	O	P	Q
FV-01WS2	6 1/4 (159)	3 7/8 (98)	6 (152)	6 7/8 (174)	5 1/2 (140)	4 7/16 (113)	11/16 (17)	3 5/8 (92)
FV-04WS2	8 3/16 (208)	5 13/16 (148)	6 3/16 (157)	8 7/16 (215)	7 5/16 (186)	5 1/4 (134)	11/16 (17)	5 9/16 (142)

WIRING DIAGRAM

FV-01WS2

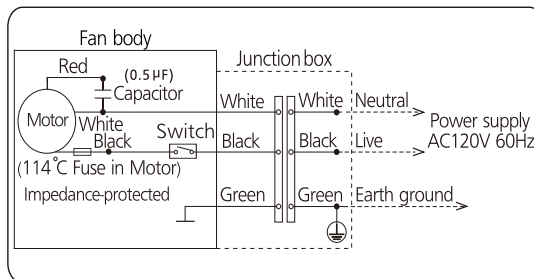

FV-04WS2

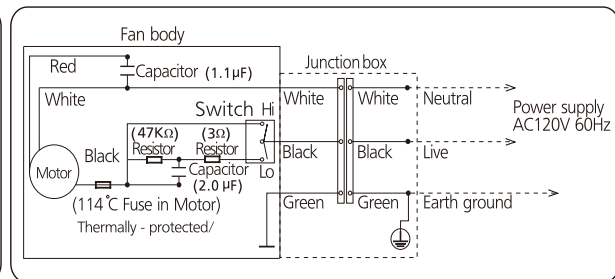

INSTALLATION I – Wall thickness is 4.5" ~ 6" (114mm~152mm)

NOTE:

1. This ventilating fan can be installed with an interior wall covering thickness of 1/2"-1 1/4" (12.7mm-31.8mm).
2. The figures below are applicable to both the FV-01WS2 model and the FV-04WS2 model.

1. Cut an interior and exterior hole matching the fan duct diameter. For the interior hole, maintain an 8" clearance between the outer hole diameter and walls or ceilings. For the exterior hole, the ideal height would be between 72" (1829 mm) and 84" (2137 mm). (Fig 1)

CAUTION

1. The hole should be made in an area where pipes, cables and telephone line are not run, and there are not studs in the way.

2. Separate the product to main unit, duct unit and hood unit. (Fig.2)

3. Unscrew two screws, lower the junction box into the duct and pull it out from duct unit. (Fig.3)

4. Insert the duct unit into wall and secure it to the drywall or other wall covering by screw II (ST4.2X20) in accessory. (Fig.4)
Before installation, adjust the direction of the duct unit in accordance with UP mark. The upper edge should be kept horizontal.

CAUTION

1. Particularly in the extremely cold area, please take thermal insulation around the duct unit, to avoid condensation.

5. Pull flexible conduit or other supply wiring through the junction box hole in the duct unit and into the room 6"-10" . (Fig.5)

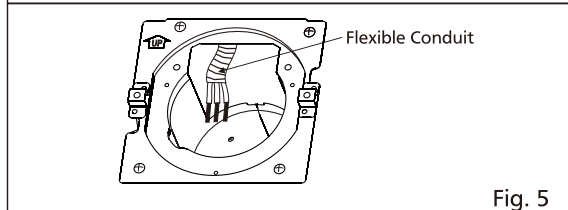
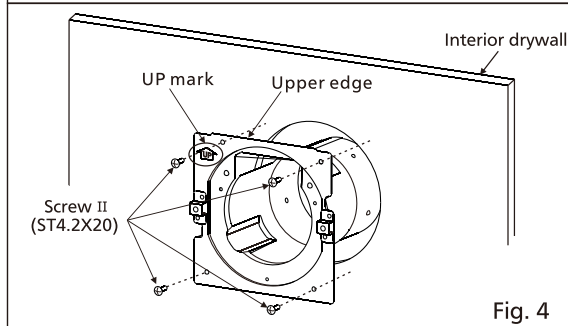
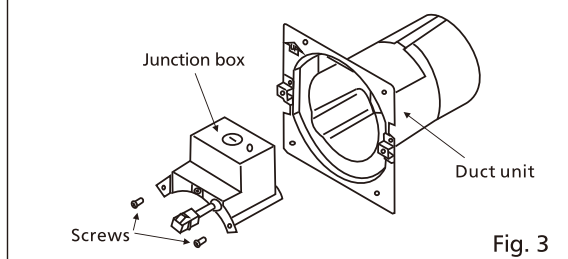
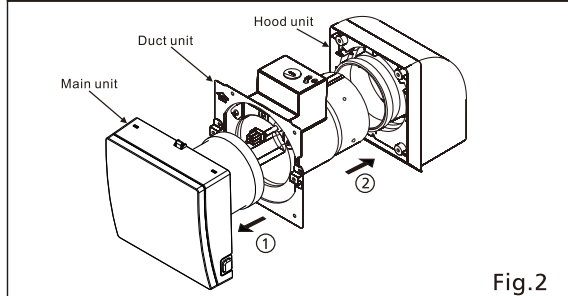
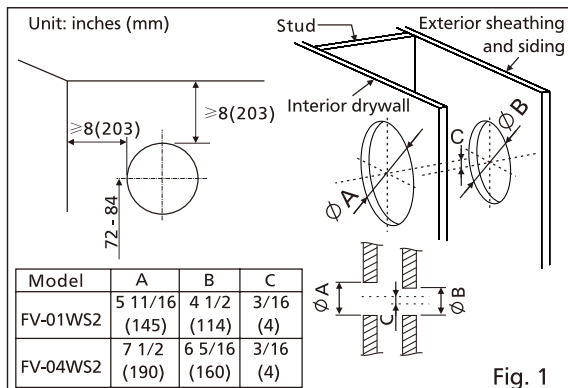

INSTALLATION I – Wall thickness is 4.5"~ 6" (114mm~152mm)

6. Open knock-out hole and unscrew the screw holding the junction box cover. After removing junction box cover, secure conduit or stress relief on the knock-out hole.(Fig.6)

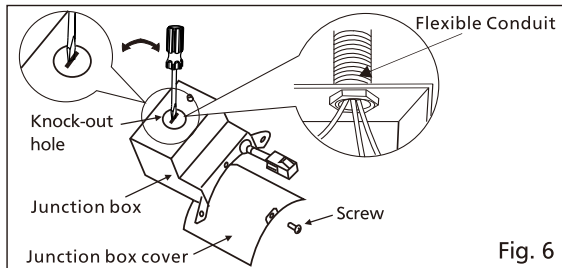

Fig. 6

7. Refer to wiring diagram (page 5). Follow all the local electrical safety codes as well as the National Electrical Code (NEC). Using UL approved wire nuts, connect house power wires to ventilating fan wires. Insure the wires are attached so that the wire connections within the Junction Box can be re-inserted into the Duct Unit. (Fig. 7)

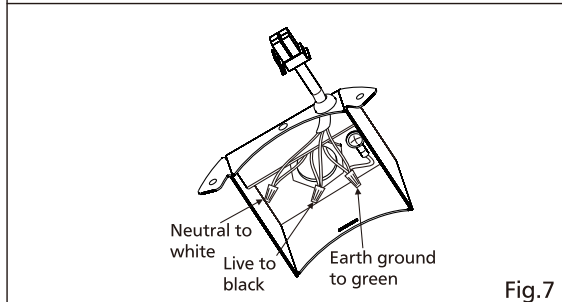

Fig. 7

8. Reattach the junction box cover to junction box by using screw. (Fig. 8)



CAUTION

- ! Mount junction box cover carefully so that lead wires are not pinched.

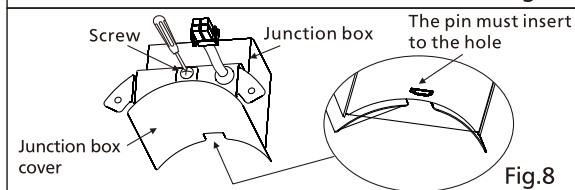

Fig.8

9. Reinstall junction box back into duct unit by using screws . (Fig.9)

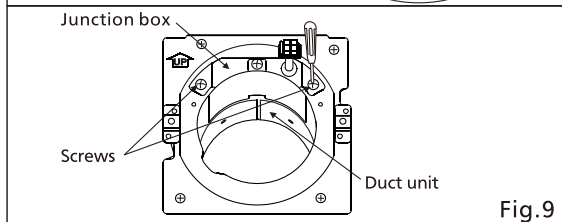

Fig.9

10. Detach the panel from fan body by pushing up and pulling outward the tab at the base of the panel.(Fig.10)

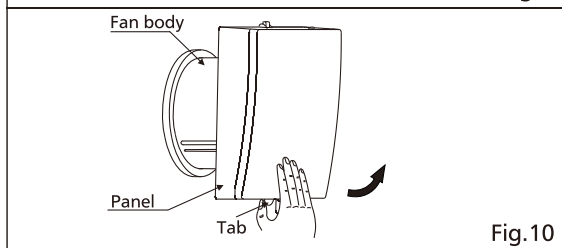

Fig.10

11. Open the cover in the top right corner of the fan body to allow the junction box pigtail and plug to come through. Insert the plastic duct of the fan body into the metal duct unit and secure it with 2 screw I (M4X10) in accessory. (Fig.11)



CAUTION

- ! Mount fan body carefully so that lead wires are not pinched.

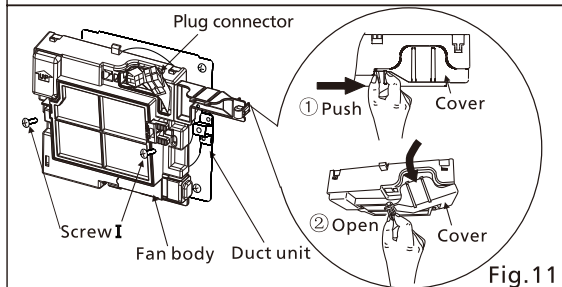

Fig.11

INSTALLATION I – Wall thickness is 4.5"~ 6" (114mm~152mm)

12. Link up the plug connector and close the cover. (Fig.12)



- ! The connection of the plug connector should be tight. After the plug connector is connected and fixed, make sure it does not tilt.

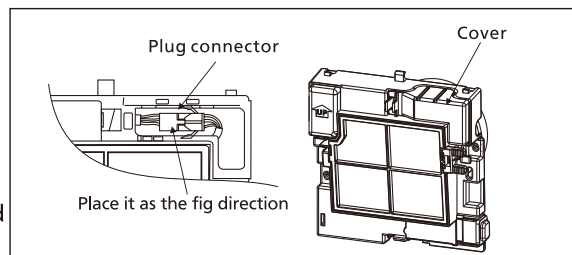

Fig.12

13. Replace the panel by hanging the panel from the mounting hinge on the top of the black plastic frame and "swinging" the cover down into place. After replacing, move the lever left and right to confirm the movement of the shutter. (Fig.13)



- ! Stop the fan while closing the shutter. Open the shutter while running the fan.

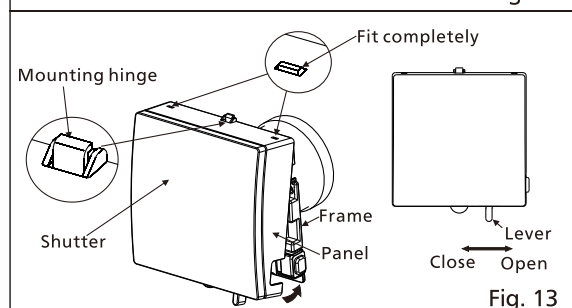

Fig. 13

14. Detach hood and hood base by loosening the screw. (Fig.14)

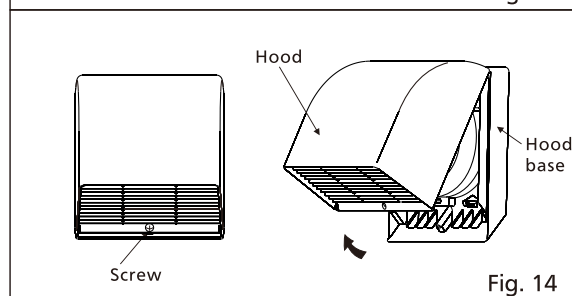

Fig. 14

15. Insert duct collar into duct and adjust the upper edge of hood base to horizontal. Secure hood base by using screwII (ST4.2x20) in accessory and seal the gap between the wall and hood base by sealant. (Fig. 15)

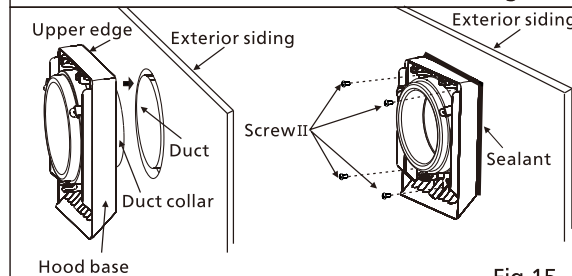

Fig.15

16. Install hood on hood base and secure it by using screw. (Fig. 16)

The rib of the hood should be matched firmly with the claw of the hood base.

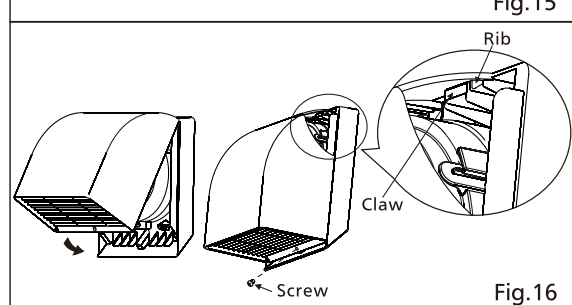

Fig.16

INSTALLATION II – Wall thickness is 6"~10" (152mm~254mm)

NOTE:

1. This ventilating fan can be installed with an interior wall covering a thickness of 1/2"-1 1/4" (12.7-31.8mm).

1. Cut holes in the wall and remove the junction box following the step1~3 of installation I .(Page 6)
2. Slip duct unit into flexible duct (not supplied) and secure it with duct tape. (Fig.17)
According to the thickness of the wall, decide the length of the flexible duct. For 10" wall, it is suggested the flexible duct length is 5" when it is in extension.
3. Insert the duct into wall and secure it with 4 screw II (ST4.2X20) in accessory. (Fig.18)
Before installation, adjust the direction of the duct unit in accordance with UP mark. The upper edge should keep horizontal.
4. Finish indoor installation following step 5~13 of installation I . (Page 6 to 8)
5. Detach hood following step 14 of installation I. (Page 8)
Press buckle on hood base and detach duct collar after loosening three buckles. (Fig.19).
6. Pull flexible duct to a suitable length through the hood base. Keep the upper edge of hood base horizontal and secure it by 4 screw II (ST4.2X20) in accessory. Seal the gap between the wall and hood base by sealant. (Fig. 20)

7. Join the flexible duct and duct collar with mastic tape. (Fig.21)
8. Press duct collar and flexible duct until duct collar fits into hood base completely.(Fig. 22)

CAUTION

 Make sure the three buckles fix the duct collar firmly.

9. Follow steps 16 of installation I (page 8) to complete the installation work.

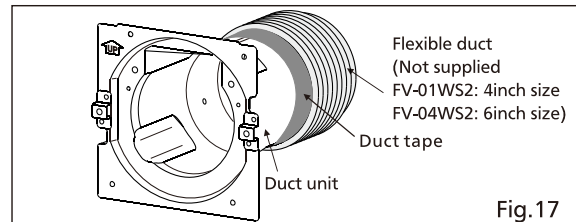

Fig.17

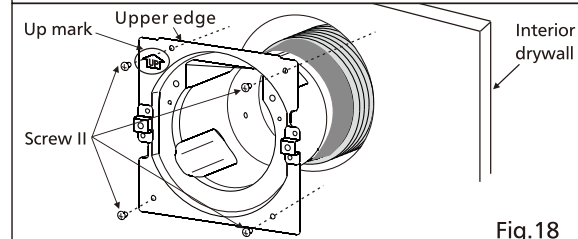

Fig.18

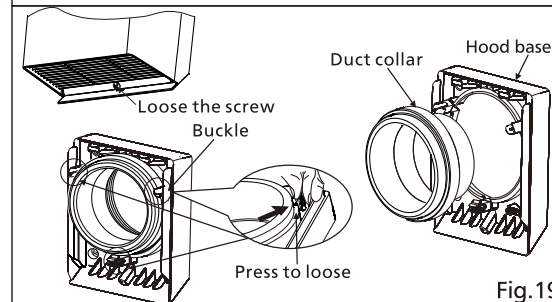

Fig.19

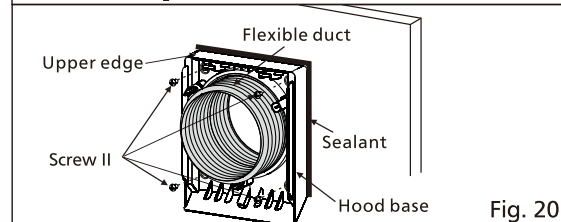

Fig. 20

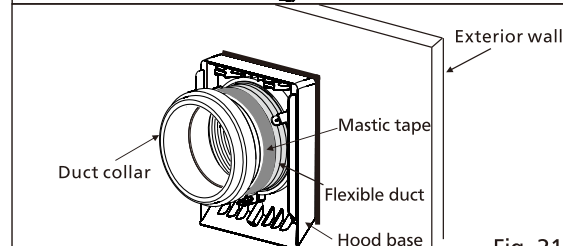

Fig. 21

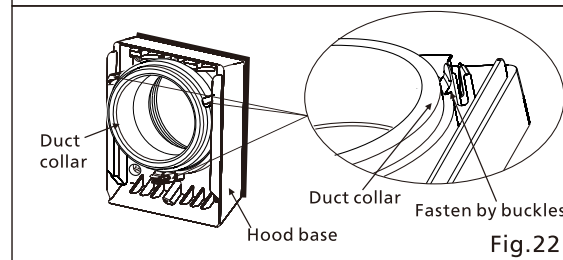











Fig.22

MAINTENANCE (CLEANING)

WARNING

-  Disconnect power source before working on unit. Maintenance must be done every year.
-  When removing the panel, beware of it in case it may fall off and cause an injury.

CAUTION

-  Never use gasoline, benzene, thinner or any other such chemicals for cleaning the ventilating fan.
-  Do not immerse motor in water when cleaning.
-  Do not soak resin parts in water over 140°F (60°C).
-  After long time use, dust may fall down when removing the panel and filter.
-  To maintain the performance of product, please clean the filter every month and replace it every year.
-  When cleaning the product, switch cap can't be removed.
-  If the filter is damaged or the filter has not been installed, insects may get into the unit.

1. Close shutter and detach the panel by pushing up the tab. (Fig.23)
2. Remove dust and dirt inside the panel by using a vacuum cleaner. Clean the surface of the panel with non-abrasive kitchen detergent and wipe dry with clean cloth. (Please do not immerse panel in water while cleaning). (Fig.24)
3. Squeeze the buckle of the filter and detach it. Remove dirt from it by using a vacuum cleaner. (Fig.25)
When replacing the filter, please purchase new filter from our representative. (Model number of filter is FV-FL01WS1 for FV-01WS2 and FV-FL04WS1 for FV-04WS2.)
4. Remove dust and dirt from fan body by using a vacuum cleaner first, and then a cloth dampened with kitchen detergent. Wipe any dirt with clean cloth. (Fig.26)
5. Replace the filter after finishing the cleaning. (Fig.27)
6. Follow step 13 of installation I (page 8) to replace the panel.

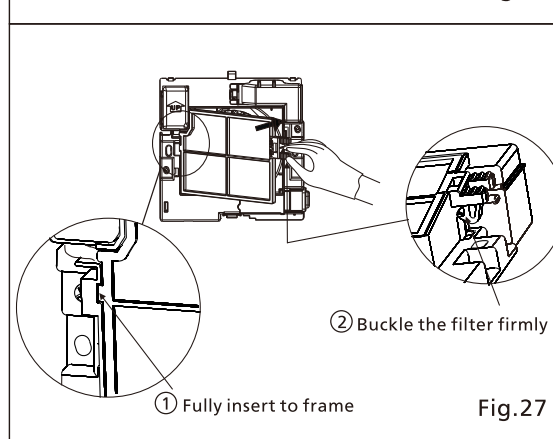
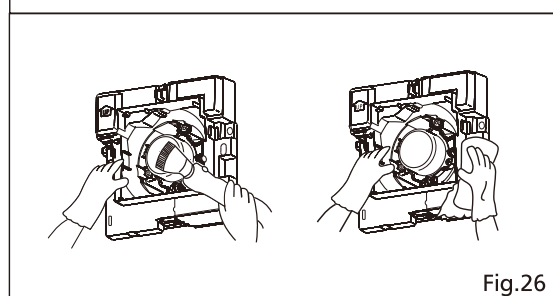
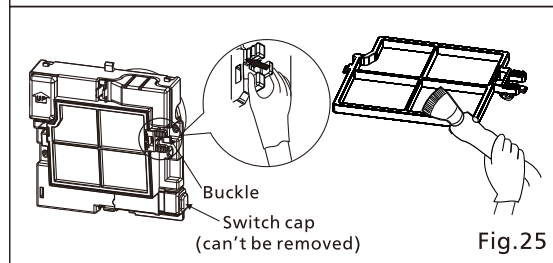
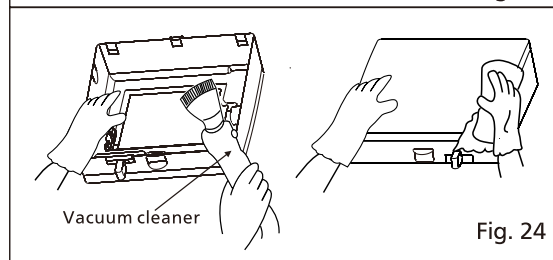
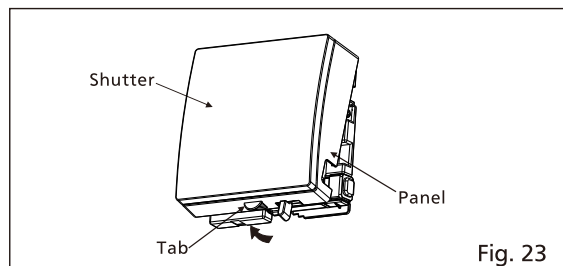

SWITCH INDICATION

FV-01WS2 Switch (Fig. 28)

" I " - Power ON (10 CFM)

" O " - Power OFF

FV-04WS2 Switch (Fig. 28)

" II " - Power ON high speed (40 CFM)

" O " - Power OFF

" I " - Power ON low speed(20 CFM)

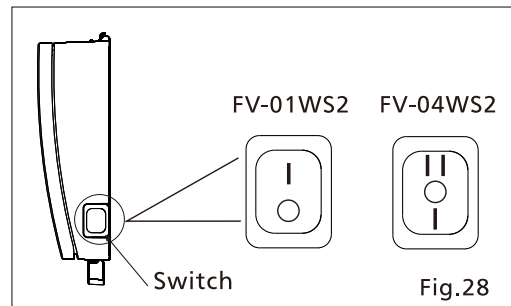

PRACTICAL GUIDE TO INSTALLATION

Properly insulate the area around the fan to minimize building heat loss and gain. (Fig.29)

Loose fill or batt insulation can be placed directly over the duct in the wall.

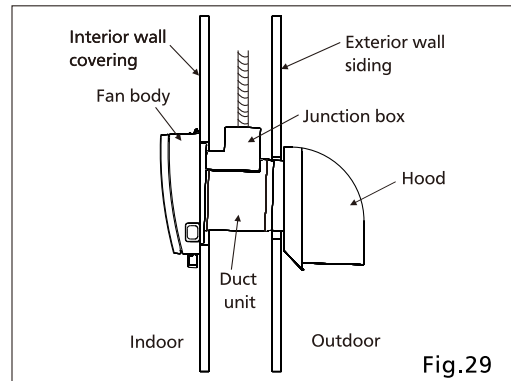

SPECIFICATIONS

Model No.	Duct diameter (inches)	Air direction	Voltage (V)	Frequency (Hz)	Noise (sones)	Power consumption (W)	Speed (r/min)	Air volume at 0.03" WG (CFM)	Weight lb.(kg)	
FV-01WS2	4	Intake	120	60	<0.3	3.0	2590	10	5.3 (2.4)	
FV-04WS2	6	Intake	Hi	120	60	1.2	8.5	2520	40	6.8 (3.1)
			Lo	120	60	<0.3	5.5	1680	20	

HVI Certified performance based on HVI Procedures 915, 916 and 920.

PRODUCT SERVICE

Warning Concerning Removal of Covers.

The unit should be serviced by qualified technicians only.

Your product is designed and manufactured to ensure a minimum of maintenance.

Should your unit require service or parts, call Panasonic Call Center at 1-866-292-7299 (USA)
or 1-800-669-5165 (Canada).

Panasonic Corporation of North America

Two Riverfront Plaza, Newark, NJ 07102
www.panasonic.com

Panasonic Canada Inc.

5770 Ambler Drive, Mississauga, Ontario L4W 2T3
www.panasonic.ca

© Panasonic corporation 2014
Printed in China

T0214-0 01WS24010

Free Manuals Download Website

<http://myh66.com>

<http://usermanuals.us>

<http://www.somanuals.com>

<http://www.4manuals.cc>

<http://www.manual-lib.com>

<http://www.404manual.com>

<http://www.luxmanual.com>

<http://aubethermostatmanual.com>

Golf course search by state

<http://golfingnear.com>

Email search by domain

<http://emailbydomain.com>

Auto manuals search

<http://auto.somanuals.com>

TV manuals search

<http://tv.somanuals.com>