

Panasonic

Multi-Function
Plain Paper FAX

Model No.

KX-F1110NZ

TO GET STARTED
EASILY,
PLEASE READ
THIS SECTION FIRST.



Quick Start

OPERATING INSTRUCTIONS

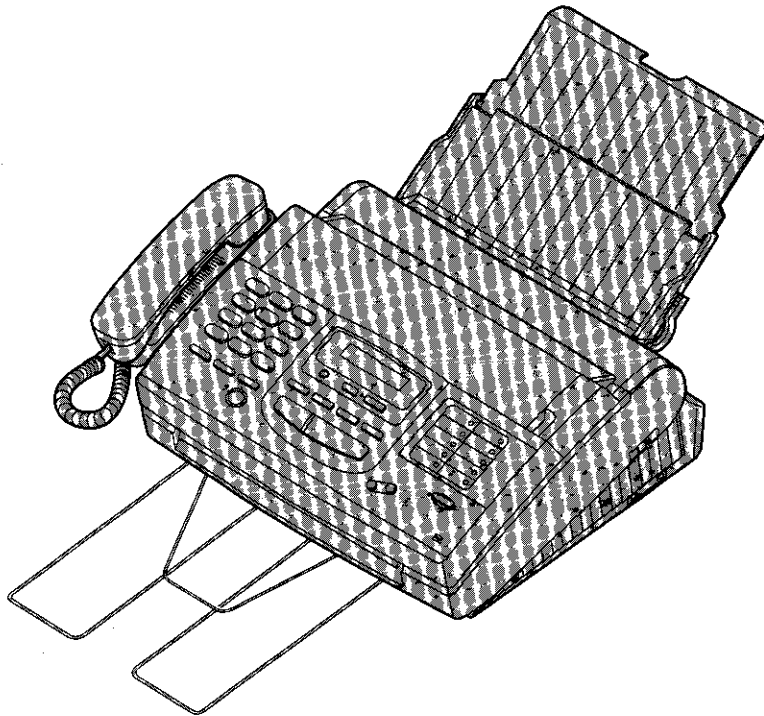

Please read these Operating Instructions
before using the unit and save for future
reference.

Table of Contents

Quick Start

Before you start	
•Included accessories	6
•Accessory order information	6
•Overview	7
Installation	
•Installing the diverter	8
•Installing the paper	8
•Connecting the telephone line and the power outlet	10
•Location of controls	11
•Help function	12
Initial preparation	
•Setting the date and time	13
•Setting your logo	14
•Setting your facsimile telephone number	15
Basic operations	
•Making voice calls	16
•Answering voice calls	17
•Making a copy	18
•Transmitting documents	20
•Receiving documents (receive mode, etc.)	22
•Operating the answering device	26
<hr/>	
	Special receiving modes
FAX mode (receiving fax documents only)	29
TEL/FAX mode (automatic voice and fax recognition)	30
	Automatic dialing
Storing telephone numbers for automatic dialing	33
Making voice calls using automatic dialing	34
Transmitting documents using automatic dialing	34
Electronic telephone directory (selecting a station name in the directory)	35
	Telephone
Voice contact (talking to the caller during or after fax reception or transmission)	36
RECALL and REDIAL/PAUSE buttons	37
	Special sending features
Polling (retrieving fax documents)	38
Delayed transmission (sending a fax at a later time)	39
Transmitting documents from memory	40
Transmitting documents to multistations	41
Reserving transmission during fax reception	43
Printing a cover page	43
	Special receiving features
Remote fax receiving (using an extension telephone to receive a fax message)	44
Junk mail prohibitor (preventing the reception of unwanted fax documents) ..	45
Receiving with a distinctive ring service (FaxAbility)	46
	Answering device
Recording your own greeting messages	47
Transferring incoming call messages	49
Operating the answering device from a remote telephone	51
	Enhanced copy features
Making an extension copy	56
Making a reduction copy	57

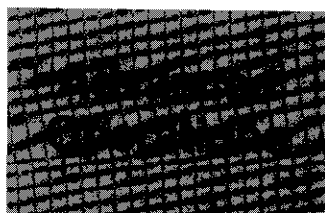

Important safety instructions

When using this unit, basic safety precautions should always be followed to reduce the risk of fire, electric shock, or personal injury.

1. Read and understand all instructions.
2. Follow all warnings and instructions marked on this unit.
3. Unplug this unit from AC outlets before cleaning. Do not use liquid or aerosol cleaners. Use a damp cloth for cleaning.
4. Do not use this unit near water, for example: near a bath tub, wash bowl, kitchen sink, etc.
5. Place this unit securely on a stable surface. Serious damage and/or injury may result if the unit falls.
6. Do not cover slots and openings on the unit. They are provided for ventilation and protection against overheating. Never place the unit near radiators, or in a place where proper ventilation is not provided.
7. Use only the power source marked on the unit. If you are not sure of the type of power supplied to your home, consult your dealer or local power company.
8. For safety purposes this product is equipped with a three prong grounded plug. If you do not have this type of outlet, please have one installed. Do not use any type of adaptor plug to defeat this safety feature.
9. Do not place objects on the power cord. Install the unit where no one can step or trip on the cord.
10. Do not overload wall outlets and extension cords. This can result in the risk of fire or electric shock.
11. Never push any objects through slots in this unit. This may result in the risk of fire or electric shock. Never spill any liquid on the unit.
12. To reduce the risk of electric shock, do not disassemble this unit. Take the unit to an authorized service center when service is required. Opening or removing covers may expose you to dangerous voltages or other risks. Incorrect reassembly can cause electric shock when the unit is subsequently used.
13. Unplug this unit from the wall outlet and refer servicing to an authorized service center when the following conditions occur:
 - A. When the power supply cord or plug is damaged or frayed.
 - B. If liquid has been spilled into the unit.
 - C. If the unit has been exposed to rain or water.
 - D. If the unit does not work normally by following the operating instructions. Adjust only controls covered by the operating instructions. Improper adjustment may require extensive work by an authorized service center.
 - E. If the unit has been dropped or physically damaged.
 - F. If the unit exhibits a distinct change in performance.
14. During thunderstorms, avoid using telephones except cordless types. There may be a remote risk of an electric shock from lightning.
15. Do not use this unit to report a gas leak, when in the vicinity of the leak.

SAVE THESE INSTRUCTIONS

INSTALLATION:

1. Never install telephone wiring during a lightning storm.
2. Never install telephone jacks in wet locations unless the jack is specifically designed for wet locations.
3. Never touch uninsulated telephone wires or terminals unless the telephone line has been disconnected at the network interface.
4. Use caution when installing or modifying telephone lines.

WARNING:

To prevent the risk of fire or electrical shock, do not expose this product to rain or any type of moisture.

OTHER INFORMATION







- Keep the unit away from electrical noise-generating devices, such as fluorescent lamps and motors.
- The unit should be kept free from dust, high temperature and vibration.
- The unit should not be exposed to direct sunlight.
- Do not place heavy objects on top of this unit.
- Do not touch the plug with wet hands.

Before you start

Included accessories

Quick Start

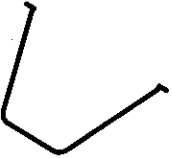
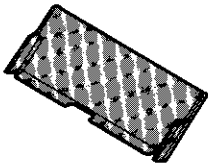
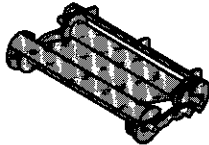
Before you start

Power cord 1 pc. 	Telephone line cord 1 pc. 	Handset 1 pc. 	Handset cord 1 pc. 
Diverter 1 pc. 	Paper tray 1 pc. 	Film cartridge 1 pc. (with starter film)  —The film cartridge is pre-installed.	Panasonic Multi-Function Center Software (Floppy disks) 3 pcs. 

- If any items are missing or damaged, contact your dealer.
- Save the original carton and packing materials for future shipping and transporting of the unit.

To use this unit with your PC

A RS232C cable is required to connect to a personal computer, see page 78. Please purchase at any computer supply store.

Accessory order information

The starter film is only 20 meters (65') long. We recommend buying regular film [100 m (328')] for extra stock.

Model No.	Description	Specifications	Comment
KX-FA135A	Film cartridge	1 cartridge and 1 film [216 mm × 100 m (8½" × 328') roll]	The film has been already installed in the cartridge.
KX-FA136A	Replacement film	2 films [216 mm × 100 m (8½" × 328') rolls]	Film only. Use with your original cartridge.

Note:

The film is not reusable. Do not rewind and use the film again.

Summary of user programmable features	58
Setting the ANS/FAX mode ring count	59
Setting the FAX mode ring count	60
Setting the TEL/FAX mode ring count	61
Setting the silent fax recognition ring count	62
Changing the caller's recording time	62
Changing the logo print position	63
Sending documents overseas	64
Film/Paper save reception	65
Receiving oversized documents	66
Changing the display contrast	67
Setting the message alert	67
Setting the recording time alert	68
Setting the memory reception alert	68
Setting the friendly reception	69
Setting the fax voice guidance	69
Changing the recording time for the ANS/FAX greeting message	70
Setting the ICM monitor	70
Signaling your pager that you have received a fax document	71
Setting the film detection	72
Resetting the advanced features	73
ECM communication	73
Printing reports and lists	74

Features	78
Preparation	78
Connecting to a computer	78
Installing the Multi-Function Center software	79
Included applications	79
Printing/faxing from a Windows application	80
Receiving faxes on your PC	84
Faxing a document on the facsimile unit	87
Making an Address Book	88
Scanning and saving documents	89
Receiving faxes directly to your fax machine	90
Getting help for further information	91

Troubleshooting

Error messages on the display	93
Before requesting help	95
If a power failure occurs... ..	97
Error codes on your PC when using Multi-Function Center software	98
Clearing a recording paper jam	100
Clearing a document jam	102
Adjusting the feeder pressure	102

Routine care

Checking the remaining film	103
Replacing the film or film cartridge	103
Cleaning the inside of the unit	105

Specifications	106
One-touch dialing list	107
Speed dialing list	108
Index	109

Installation

Installing the diverter

Insert the diverter into the slots on the main unit until it clicks into place.

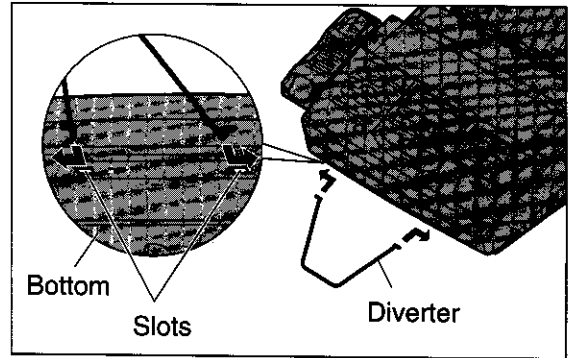

Quick Start

Installation

Installing the paper

The recording paper size that can be loaded is A4. The paper tray can hold up to 150 sheets of 75 g/m² (20 lb.) paper. Use 60 to 90 g/m² (16 to 24 lb.) paper.

- 1 Open the paper tray.

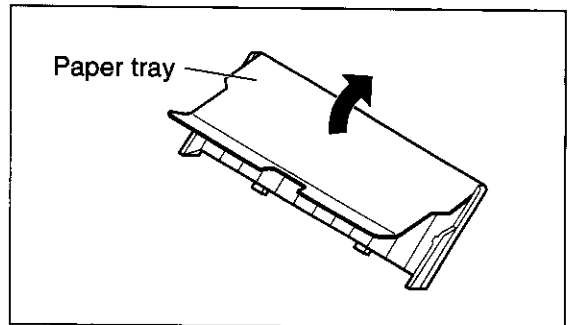

- 2 Insert the two fins on the paper tray into the slots on the back of the unit.

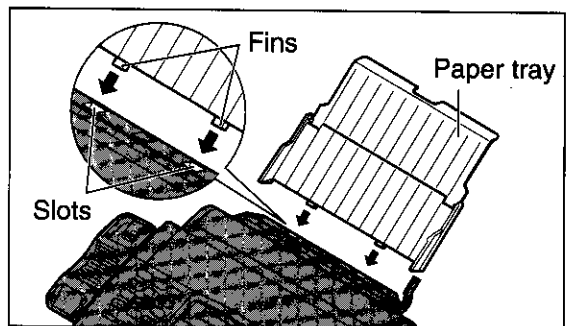

- 3 Pull the recording paper set lever forward.

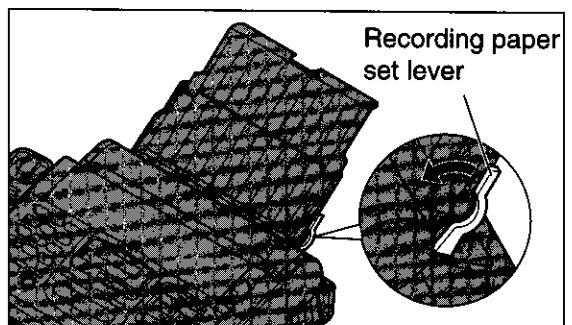

Overview

Quick Start

Before you start

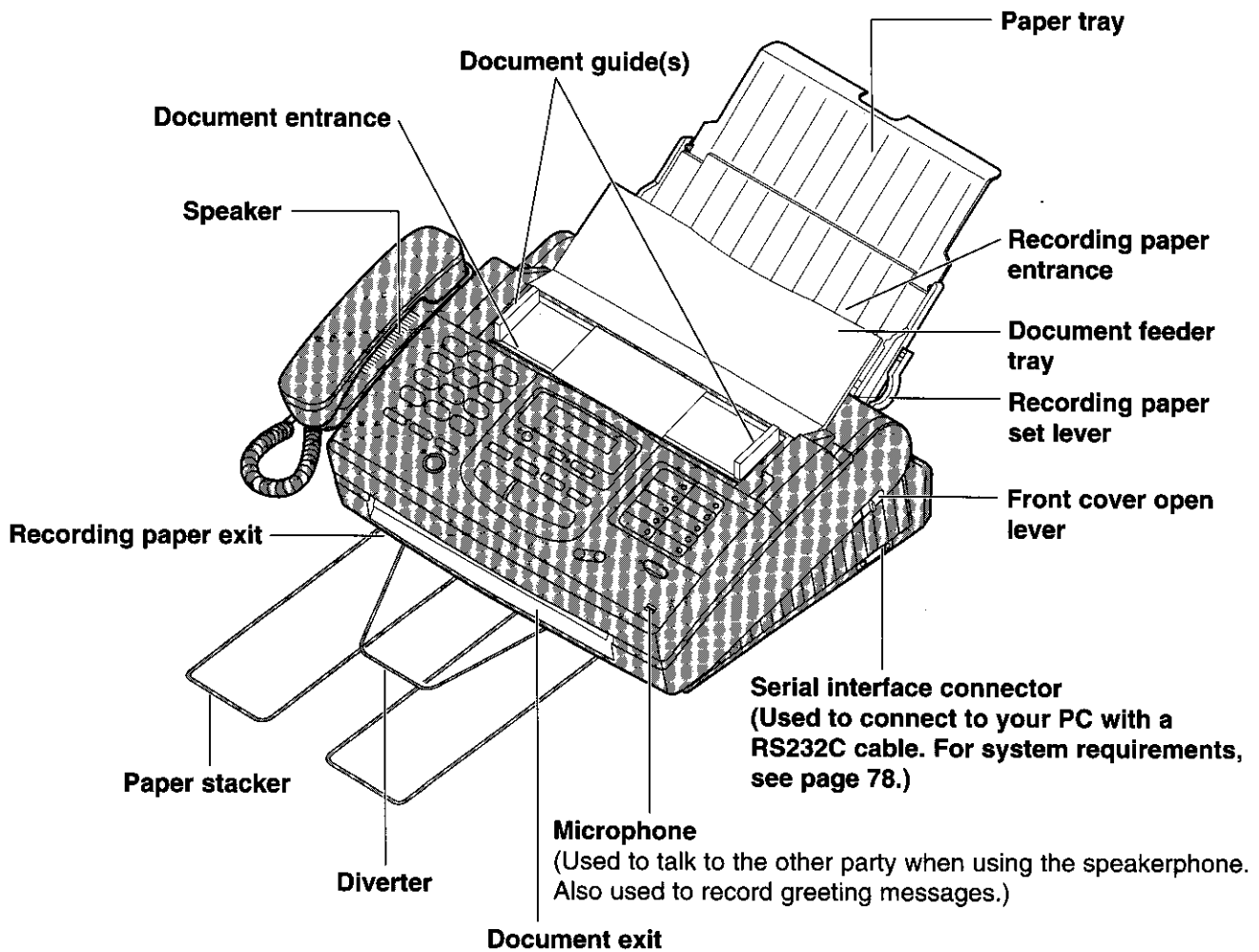

Connecting the telephone line and the power outlet

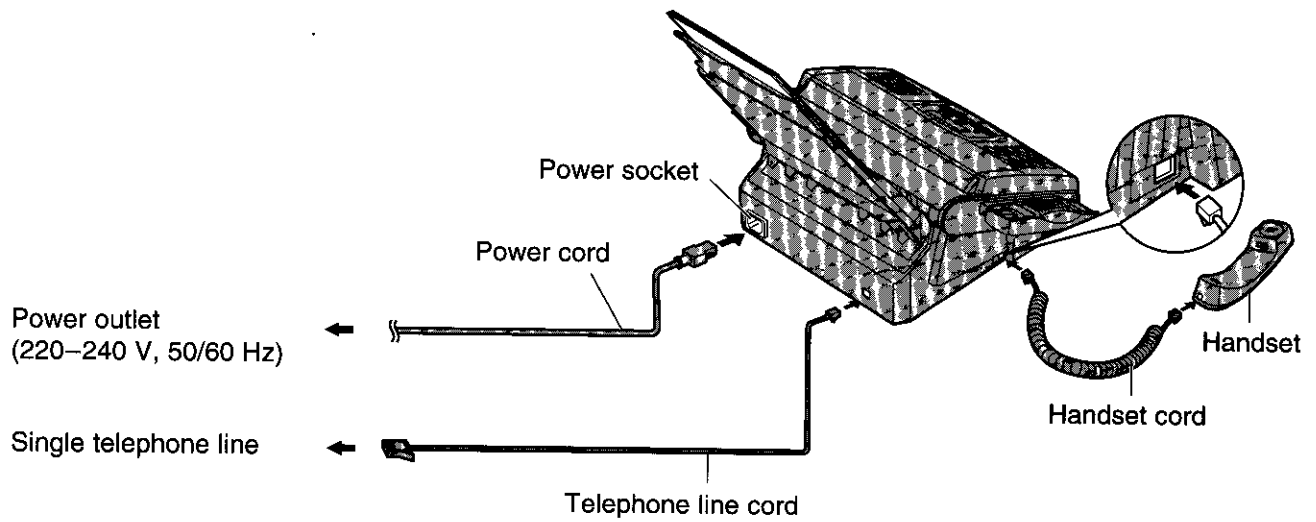
**Note:**

- When you operate this product, the power outlet should be near the product and easily accessible.
- If the following message is displayed when the unit is plugged in, the recording paper set lever is released.

Display:

CHECK LEVER

Move the lever back (see step 5 on page 9).

- 4** Fan the stack of paper to avoid a paper jam and insert the paper into the paper tray.
- The height of the stack of the paper should not exceed the upper limit on the paper tray, or it may cause a paper jam.
 - The paper should not be over the tab.
 - If the paper is not inserted correctly, readjust the paper or a paper jam may occur.

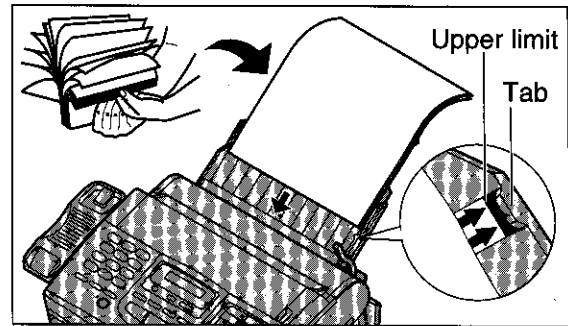
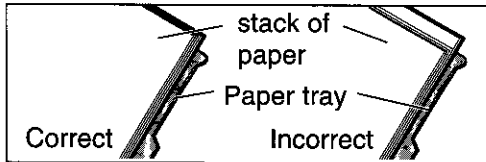

- 5** Move the recording paper set lever back. Pull out the paper stacker completely from the bottom of the unit.
- Do not place the unit in areas where the paper tray may be obstructed by walls, etc.

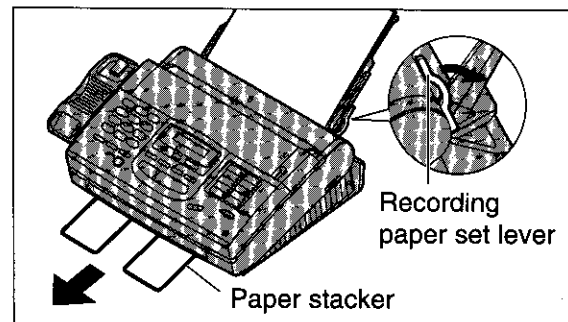

Note:

- Do not use different types or thicknesses of paper in the paper tray at the same time. This may cause a paper jam.
- Avoid extremely smooth or shiny paper that is highly textured. Also avoid paper that is coated, damaged or wrinkled or paper with a cotton and/or fiber content that is over 20%.
- Avoid used paper for double-sided printing.
- Do not use paper printed from this unit for double-sided printing with other copiers or printers, or a paper jam may occur.

Adding paper to the paper tray

1. Pull the recording paper set lever forward.
 - The unit will beep and the following message is displayed.

Display: CHECK LEVER

2. Remove the paper from the paper tray.
3. Add more paper to the removed paper.
4. Fan the entire stack of paper and insert it into the paper tray.
5. Move the recording paper set lever back.

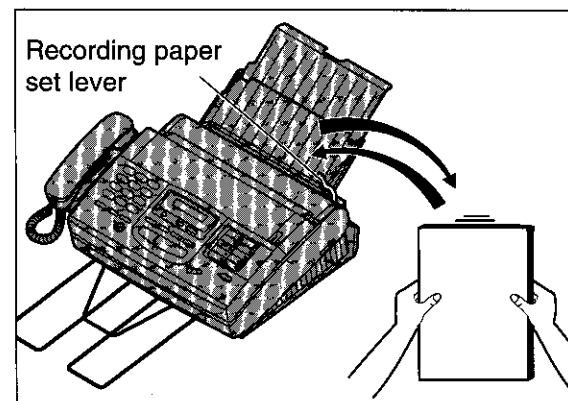

Location of controls (cont.)

Answering control buttons

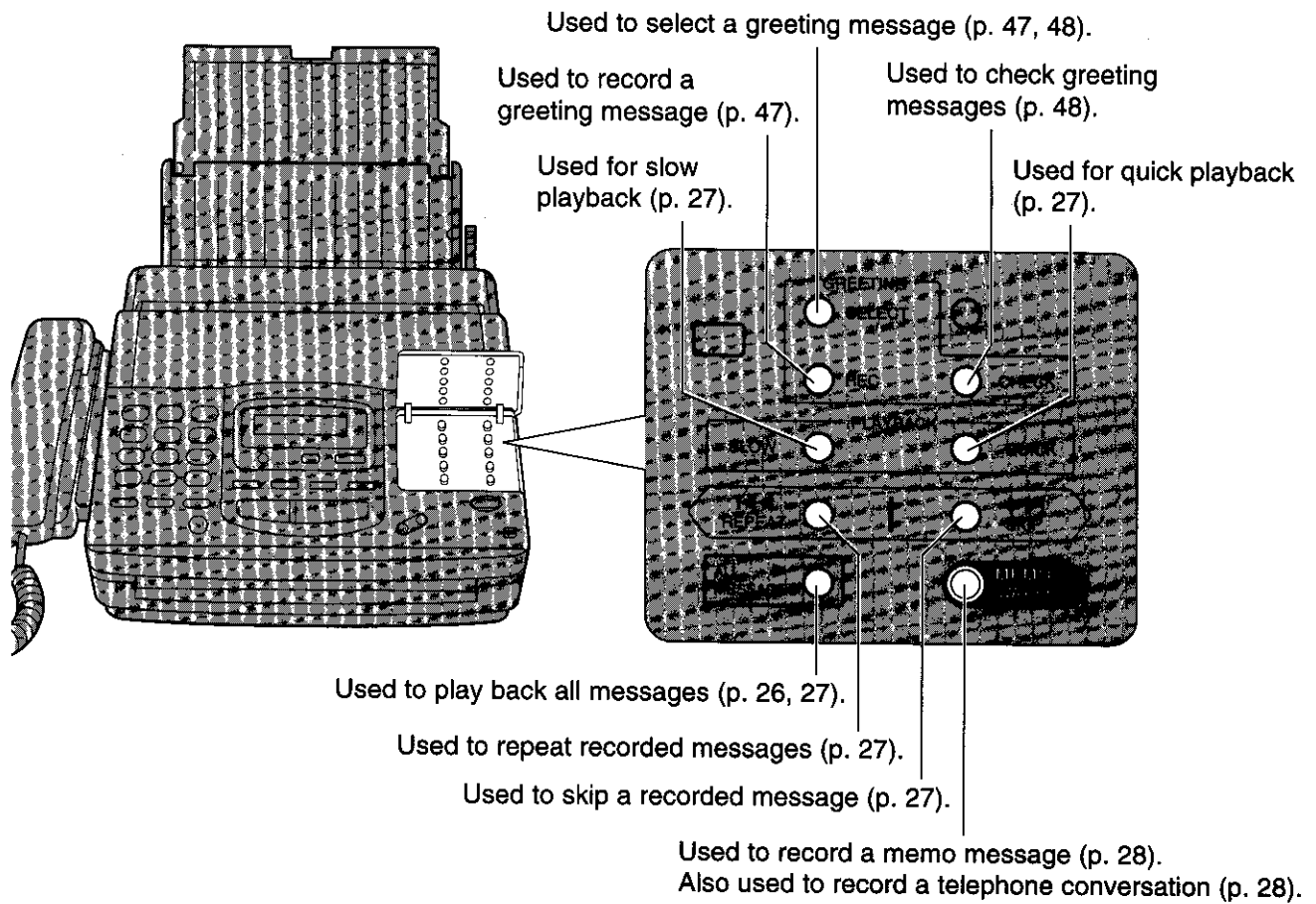

Help function

For assistance, press **HELP**. The unit will print a quick reference.

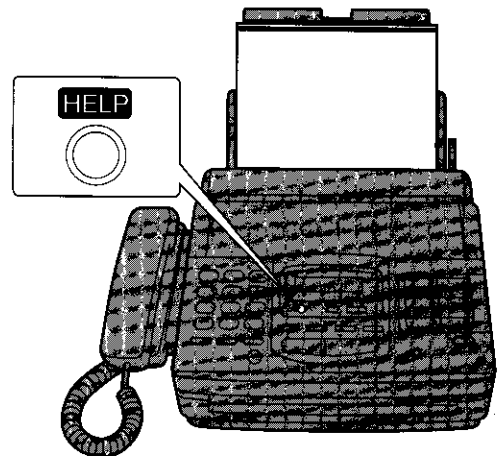

Location of controls

Control panel

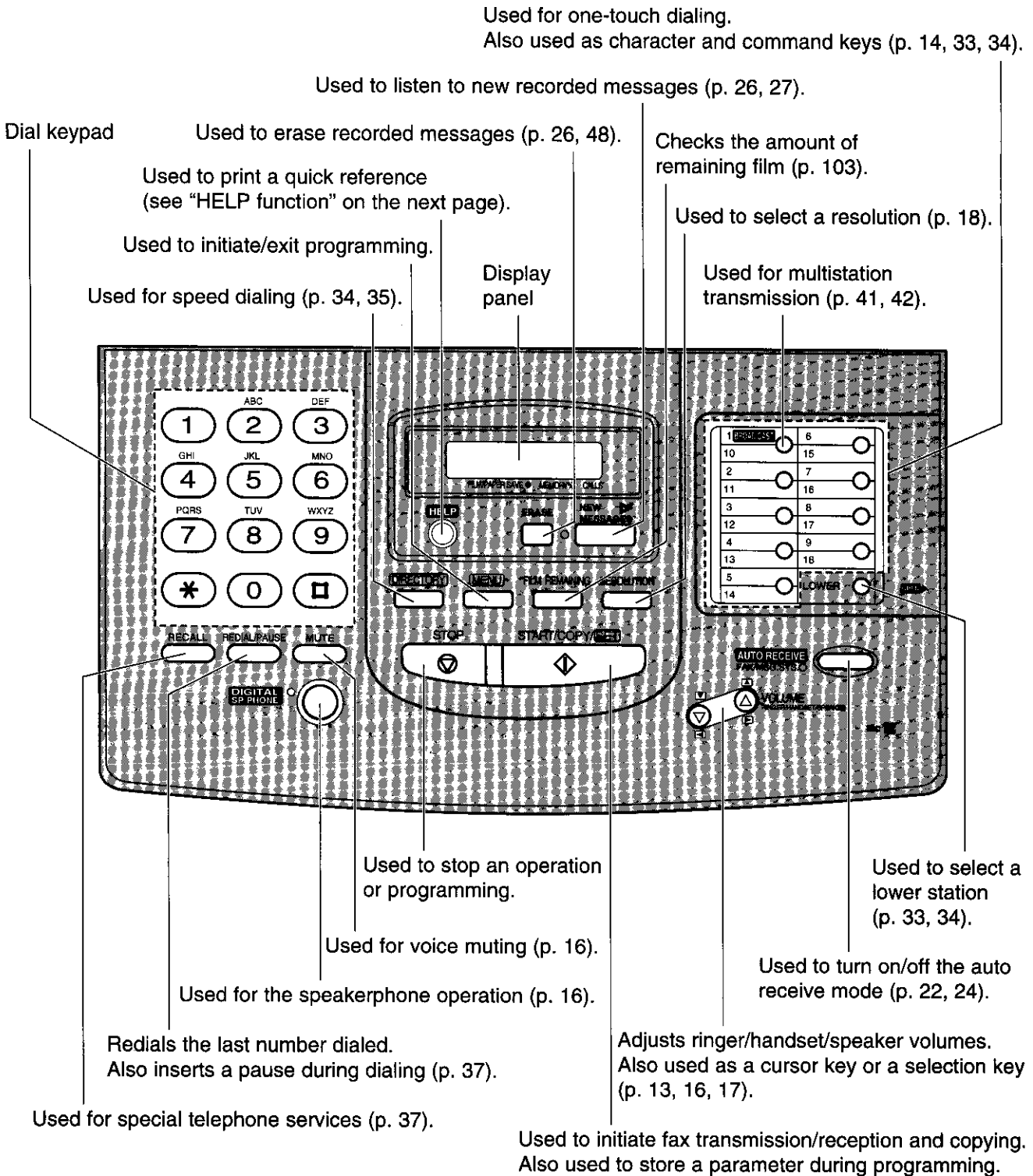

Setting your logo

The logo can be a company, division or personal name in an abbreviated form.

1 Press **MENU**.
 Display: SYSTEM SET UP

2 Press **#**, then **0 2**.
 YOUR LOGO

3 Press **START/COPY/SET**.
 LOGO=

4 Enter your logo up to 30 characters using the dial keypad and direct call station keys.

For example, when entering "Bill" as your logo:

1. Press **2** twice. LOGO=B

2. Press **4** six times. LOGO=Bi

3. Press **5** six times. LOGO=Bill

4. Press **▶** (**VOLUME**) to move the cursor and press **5** six times. LOGO=Bill

Note:
 • If you use the same number key continuously to enter the next character, press **▶** (**VOLUME**) to move the cursor.

5 Press **START/COPY/SET**.

6 Press **MENU**.

To correct a mistake while programming

Use **◀▶** (**VOLUME**) to move the cursor to the incorrect character, then make the correction.
 or
 Press **STOP** to delete the character to the left of the cursor.

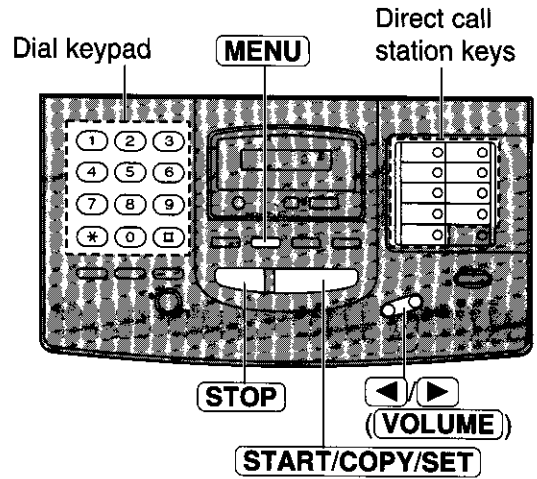

Character table

Keys	Characters
1	1 [] { } + - / = . , _ ' `
2	A B C a b c 2
3	D E F d e f 3
4	G H I g h i 4
5	J K L j k l 5
6	M N O m n o 6
7	P Q R S p q r s 7
8	T U V t u v 8
9	W X Y Z w x y z 9
0	0 () < > ! " # \$ % & ¥
1	: ; ? * @ ^ ' →
2	INSERT key (Used to insert one character or one space.)
3	SECRET key (Used for automatic dialing on page 33.)
6	SPACE key (Used to replace one character with a space.)
7	DELETE key (Used to delete one character.)
8	HYPHEN key (Used to insert a hyphen.)
◀	◀ key (Used to move the cursor to the left.)
▶	▶ key (Used to move the cursor to the right.)

Initial preparation

Before using your unit, program the correct date and time, your logo and your facsimile telephone number.

This information will be printed on the top of each page transmitted from your unit.

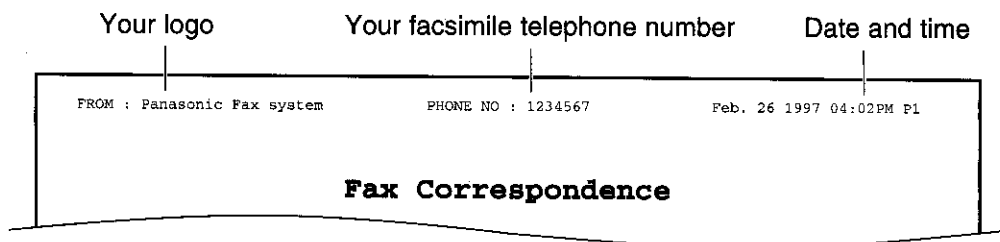

Setting the date and time

1 Press **MENU**.
Display: SYSTEM SET UP

2 Press **#**, then **0 1**.
SET DATE & TIME

3 Press **START/COPY/SET**.

4 Enter the correct month/day/year by selecting each 2 digits.

Example: Aug. 10 1997

Press **0 8 1 0 9 7**.

M:08/D:10/Y:97

- If you make a mistake, press **◀/▶** (**VOLUME**) to move the cursor to the incorrect number, then make corrections.

5 Press **START/COPY/SET**.

6 Enter the correct hour/minute by selecting each 2 digits.

Press ***** to select AM or PM.

Example: 3:00PM

Press **0 3 0 0**, then press ***** until PM is displayed.

TIME: 03:00PM

- If you make a mistake, press **◀/▶** (**VOLUME**) to move the cursor to the incorrect number, then make corrections.

7 Press **START/COPY/SET**.

8 Press **MENU**.

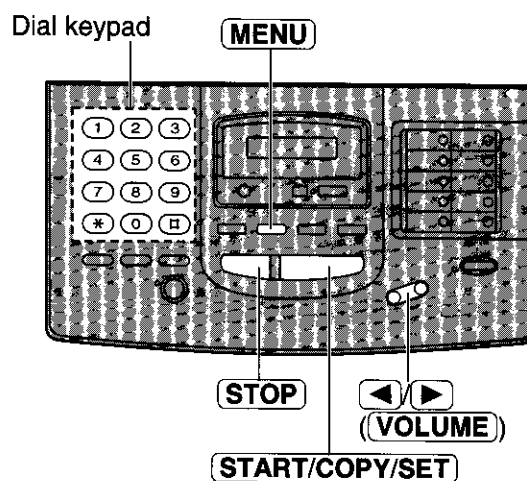

Note:

- If you press **STOP** while programming, the display will return to the previous one.
- The accuracy of the clock will be approximately ± 60 seconds a month.

Basic operations

Making voice calls

Quick Start

- 1 Press **DIGITAL SP-PHONE** or lift the handset.
- 2 Dial the telephone number.
 - If you misdial, press **DIGITAL SP-PHONE** or hang up and dial again.
- 3 When the other party answers, speak into the microphone or handset.
- 4 When finished, press **DIGITAL SP-PHONE** or hang up the handset.

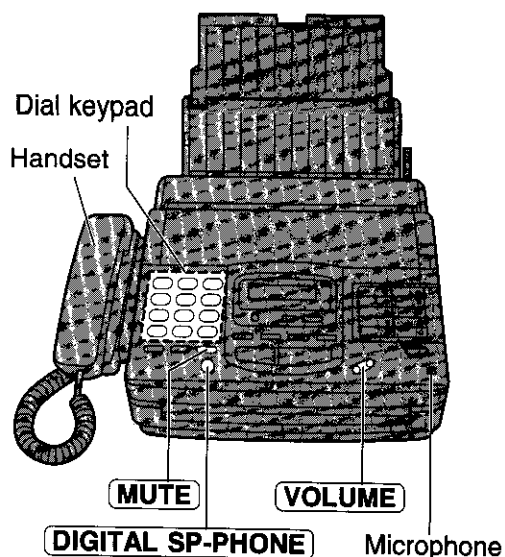

Basic operations

Voice muting

Using this feature, the other party cannot hear you but you can hear them.

1. Press **MUTE** during a telephone conversation.

Display: <MUTE>

2. To resume the conversation, press **MUTE**.

Handset volume

Press **VOLUME** (▼/▲) while using the handset.

- 3 levels (high/middle/low) are available.

Speaker volume

Press **VOLUME** (▼/▲) while using the speakerphone.

- 8 levels (high to low) are available.

Hints for speakerphone operation:

- Use the speakerphone in a quiet room.
- If you have difficulty hearing the other party, adjust the volume using **VOLUME**.
- If you and the other party speak at the same time, parts of your conversation will be cut off.
- To switch to the handset, lift the handset. To switch back to the speakerphone, press **DIGITAL SP-PHONE**.

Setting your facsimile telephone number

- 1 Press **MENU**.
Display: SYSTEM SET UP
- 2 Press **#**, then **0** **3**.
YOUR TEL NO.
- 3 Press **START/COPY/SET**.
NO. =

- 4 Enter your facsimile telephone number up to 20 digits.
 - The **#** button inserts a space and the ***** button a "+".
 - To correct a mistake:
Use **◀/▶** (**VOLUME**) to move the cursor to the incorrect character, then make the correction.
or
Press **STOP** to delete the character to the left of the cursor.

Example for New Zealand:

+64 9 1234567

Press ***64#9#1234567**.

- 5 Press **START/COPY/SET**.
- 6 Press **MENU**.

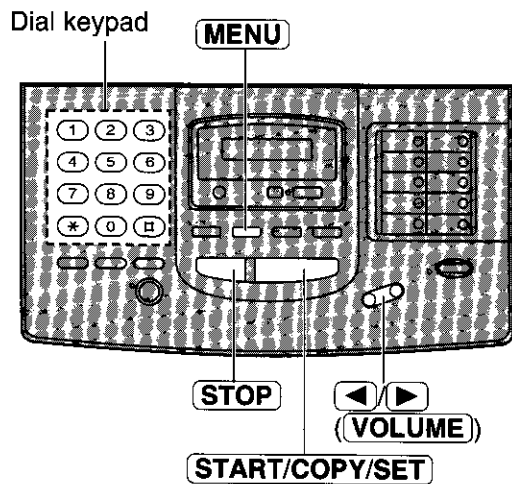

Making a copy

Any transmittable document can be copied.

- 1** Open the document feeder tray.
- 2** Insert the documents (up to 15 sheets) **FACE DOWN** until a beep tone is heard.
- 3** Adjust the document guides to the width of the document.
- 4** Press **RESOLUTION** repeatedly to the desired setting, if needed (see below).
- 5** Press **START/COPY/SET**.
 - The unit will start printing.

Note:

- If a resolution is not set, FINE resolution will automatically be selected.
- You can make or receive a voice call while making a copy.

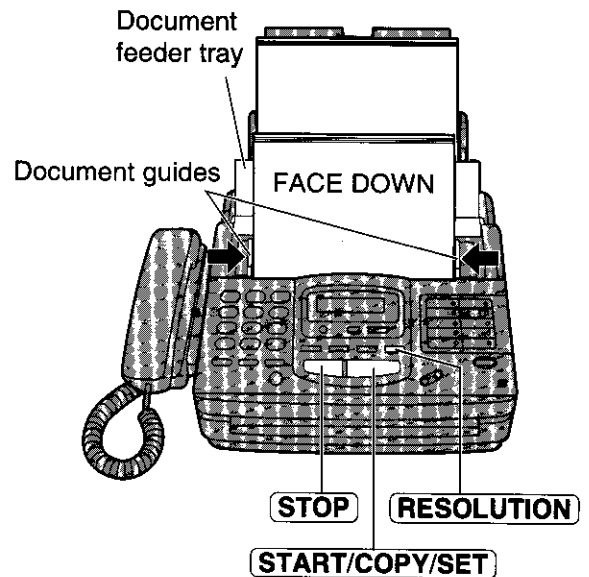

To stop copying

Press **STOP**.

Selecting the resolution

You can select the desired resolution by pressing **RESOLUTION**.

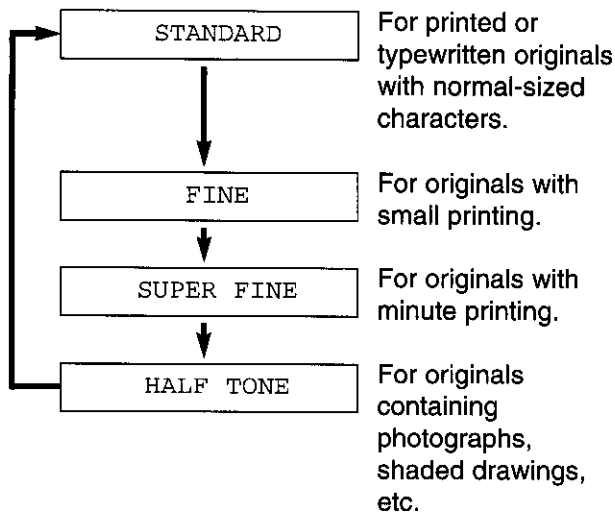

Note:

- Using the fine, super fine or half tone setting will increase the transmission time.
- If the resolution setting is changed during feeding, it will be effective from the next sheet.
- The super fine resolution only works with other compatible machines.

To feed 16 or more sheets at a time

Insert the first 15 sheets of the document. Add the extra sheets (up to 15) before the last sheet is fed into the unit.

Answering voice calls

- 1 When the unit rings, press **DIGITAL SP-PHONE** or lift the handset.
- 2 When finished, press **DIGITAL SP-PHONE** or hang up the handset.

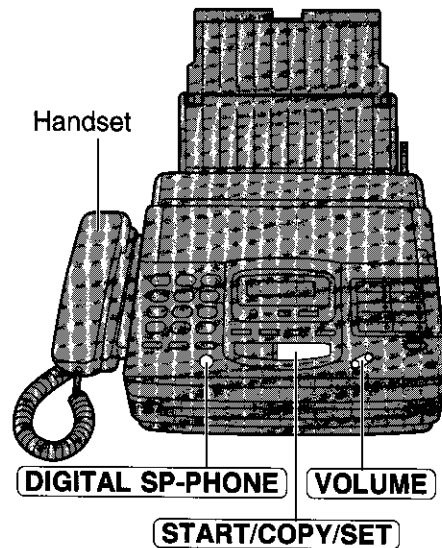

Ringer volume

Press **VOLUME** (▼/▲) while the unit is idle.

- 4 levels (high/middle/low/off) are available.

To turn the ringer off:

1. Press **VOLUME** (▼) repeatedly.
 - The following messages will be shown alternately:

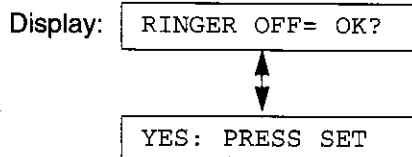

2. Press **START/COPY/SET**.

While the ringer volume is set to off:

The display will show the following message and the unit will not ring when receiving a call:

RINGER OFF

When receiving a call, the unit will not ring, but will show the following message:

INCOMING CALL

Transmitting documents

- 1 Open the document feeder tray.
- 2 Insert the documents FACE DOWN (up to 15 sheets) until a beep tone is heard.
- 3 Adjust the document guides to the width of the document.
- 4 Press **RESOLUTION** repeatedly to the desired setting, if needed (see page 18).
- 5 Press **DIGITAL SP-PHONE** or lift the handset.
- 6 Dial the telephone number.
 - If you misdial, hang up and dial again.
- 7 When a fax tone is heard, press **START/COPY/SET**.
- 8 Hang up the handset if using it.

Note:

- If the other party answers your call, ask them to start receiving a fax, then press your **START/COPY/SET**.

To stop transmission

Press **STOP**.

- To eject the document, press **STOP** again.

Fax voice guidance about transmission

After transmission, one of the following messages will tell you the result.

— *Transmission is complete.*

— *Transmission has failed.*

— *Transmission has been interrupted.*

You can set this feature to OFF and the guidance will not be heard. Or you can set this feature to ERROR and the guidance will prompt you only when fax transmission fails (see page 69).

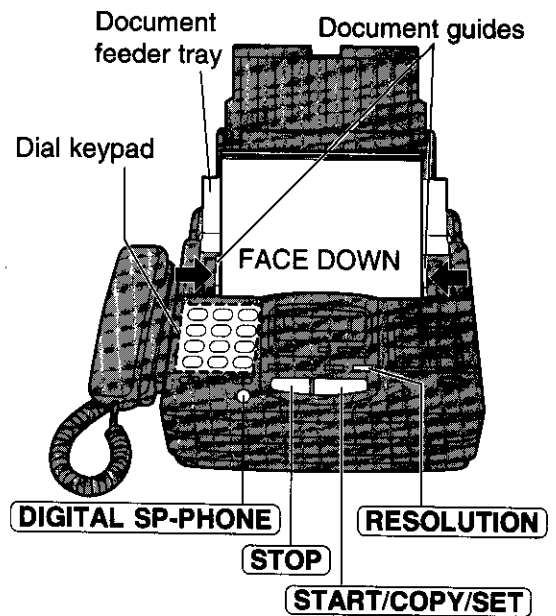

Documents the unit can feed

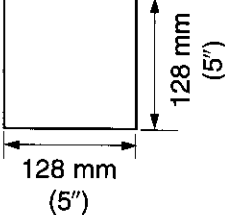
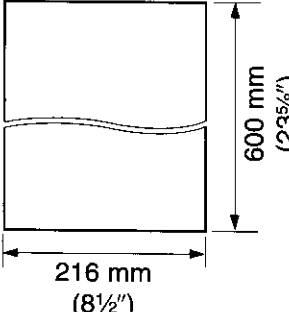
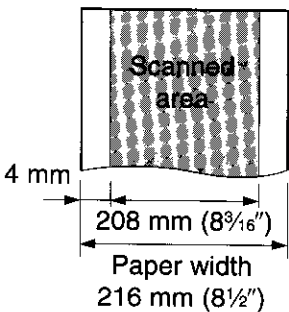
Minimum size	Maximum size	Effective scanning area	Document weight
 <p>128 mm (5")</p>	 <p>600 mm (23⁵/₈")</p> <p>216 mm (8¹/₂")</p>	 <p>4 mm</p> <p>208 mm (8³/₁₆")</p> <p>Scanned area</p> <p>Paper width 216 mm (8¹/₂")</p>	<p>Single sheet: 45 to 90 g/m² (12 to 24 lb.)</p> <p>Multiple sheets: 60 to 75 g/m² (16 to 20 lb.)</p>

Note:

- Remove clips, staples or other similar fastening objects.
- Check that ink, paste or correction fluid has dried.
- Do not send the following types of documents: (Use copies for fax transmission.)
 - Chemically treated paper, such as carbon or carbonless duplicating paper
 - Electrostatically charged paper
 - Heavily curled, creased or torn paper
 - Paper with a coated surface
 - Paper with a faint image
 - Paper with printing on the opposite side that can be seen through the front (e.g. newspaper)

Receiving documents (receive mode, etc.)

Setting the receive mode

The unit has two receive modes:

The **AUTO RECEIVE** mode allows your unit to receive all calls automatically without your assistance. Use this mode when you wish to use the unit solely as a facsimile machine or when you are going out.

The **MANUAL RECEIVE** mode lets you answer calls by lifting the handset. Use this mode when you are in and wish to answer voice and fax calls.

These modes can be selected by pressing the **AUTO RECEIVE** button.

AUTO RECEIVE and MANUAL RECEIVE have two different receive settings.

MANUAL RECEIVE MODE

AUTO RECEIVE
FAX/MSG.SYS. ●

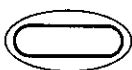

The FAX/MSG.SYS. indicator is off.

TEL mode (pre-selected)

Allows you to answer all calls manually.

When the unit rings, you must answer all calls by picking up the handset.

- When a fax call is received, you can start fax reception by pressing **START/COPY/SET**. For further details, see page 23.
- You can change to the ANS/FAX mode from a remote location. Call your unit from a touch tone telephone and wait for 15 rings. The answering system will temporarily answer the line. Then enter the remote operation ID (page 52) during the greeting message. The unit will switch to the ANS/FAX mode.

TEL/FAX mode

Automatic voice and fax recognition

When a fax call is detected, the unit will automatically answer the line and start reception. When a voice call is detected, the unit will start to ring. You can lift the handset to answer the call.

For further information about this mode, see pages 30 through 32. To change the number of rings before a call is answered, see page 61.

AUTO RECEIVE MODE

AUTO RECEIVE
FAX/MSG.SYS. ●



The FAX/MSG.SYS. indicator is on.

ANS/FAX mode (pre-selected)

Records voice messages and/or receives fax documents.

When a voice call is detected, the telephone answering system will record the voice message. When a fax call is detected, the unit will receive fax documents (see pages 24 and 25). To change the number of rings before a call is answered, see page 59.

FAX mode

Receives fax documents only.

The unit will answer all calls automatically and activate the fax function (see page 29). To change the number of rings before a call is answered, see page 60.

Note:

- Regardless of the mode you select, you can always place calls and send faxes.
- See page 44, "Remote fax receiving (using an extension telephone to receive a fax message)".

Need help?—Follow the voice guide

1 Press **MENU** until the following is displayed.
 Display: **XMT VOICE GUIDE**

2 Press **HELP**.
Voice guide:
To transmit, insert the document face down until you hear the beep.

3 Insert the documents **FACE DOWN** until a beep tone is heard.
Voice guide:
Press the speaker phone button, then dial the phone number. When the fax tone is heard, press the start button.

4 Press **DIGITAL SP-PHONE**.

5 Dial the telephone number.

6 When a fax tone is heard, press **START/COPY/SET**.
Voice guide:
Start transmission.

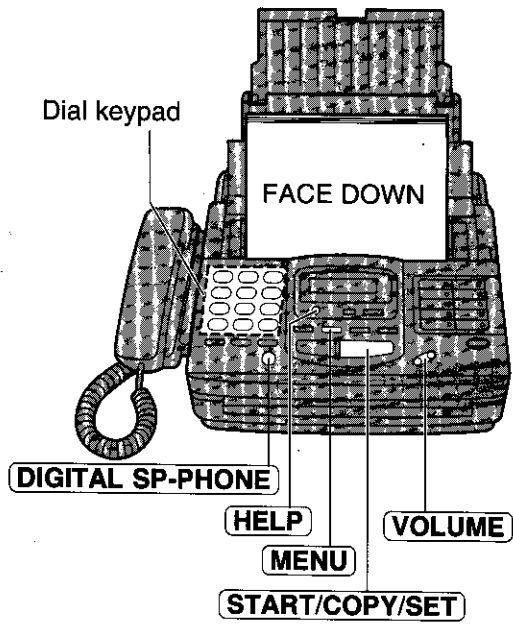

Note:
 • You can lift the handset instead of pressing **DIGITAL SP-PHONE** in step 4.

Fax voice guidance volume

Press **VOLUME** (**▼**/**▲**) while listening to the voice guidance.
 • 9 levels (high to off) are available.

Receiving documents (receive mode, etc.) (cont.)

Receiving fax documents and/or recording incoming voice messages automatically (ANS/FAX mode)

When you turn on the AUTO RECEIVE mode (pre-selected setting is ANS/FAX), the unit will work as a facsimile machine and/or answering device.

If a fax call is detected, the unit will automatically switch to receive faxes.

If a voice call is detected, the answering system will begin recording, then the caller can leave a voice message.

- You can use a pre-recorded greeting message (see the next page) or record your own greeting message (see page 47).

Setup of voice message and document reception

The total recording time (including the greeting messages) is about 18 minutes. If messages are recorded in a noisy environment, the recording time may be shortened up to 11 minutes.

To record incoming voice messages and receive fax documents, follow the steps below:

- 1 Make sure that the AUTO RECEIVE mode is set to ANS/FAX (see page 29).

- 2 To turn on the AUTO RECEIVE mode, press **AUTO RECEIVE** until the FAX/MSG.SYS. indicator light goes on.

- The display shows the following message:

Display: ANS/FAX MODE

The remaining time for recording incoming messages will be displayed.

Example: TIME LEFT=10m13s

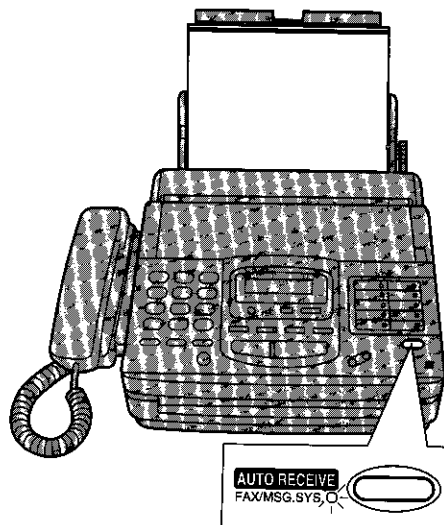

The FAX/MSG.SYS. indicator is on.

Note:

- Each incoming message recording time can be set to either 1 minute or unlimited. To change the setting, see page 62.
- When the remaining time is low, erase unnecessary messages from memory (see pages 26 and 54).
- While an incoming call is being recorded, you can monitor it through the speaker. If this feature is not required, set the ICM monitor feature to OFF (see page 70).

Allowing you to answer all calls manually (TEL mode)

- 1** When the unit rings, press **DIGITAL SP-PHONE** or lift the handset to answer the call.
- 2** When:
 - document reception is required,
 - a slow beep is heard, or
 - no sound is heard,
 press **START/COPY/SET**.
- 3** Hang up the handset, if using it.

Note:

- If you do not answer a call by 15 rings, the unit will temporarily activate the fax function to receive documents.
- See page 44, "Remote fax receiving (using an extension telephone to receive a fax message)".

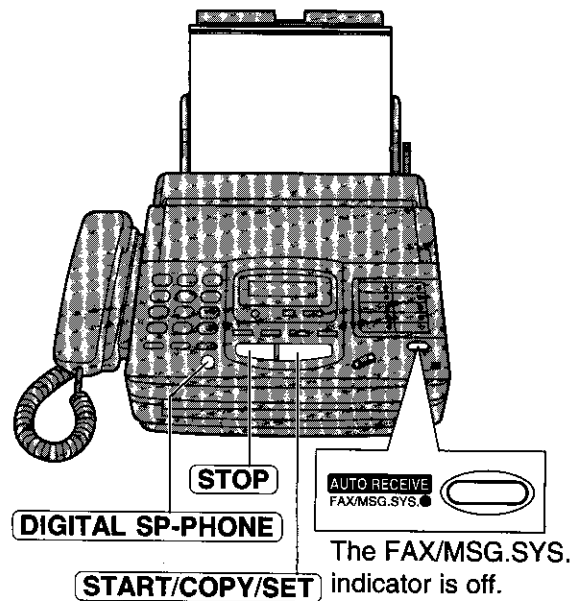

Friendly reception

When you answer the call and hear a slow beep, the unit will automatically start fax reception even if you do not press **START/COPY/SET**.

- If this feature is not required, set to OFF (see page 69).

When friendly reception is activated, one of the following messages will be heard.

- *Please hang up the handset for reception.*
- *Start reception.*

- If the voice guidance feature is set to OFF, these messages will not be heard (see page 69).

Fax voice guidance about reception

After reception, one of the following messages will tell you the result.

- *Reception is complete.*
- *Reception has failed.*
- *Reception has been interrupted.*

- You can set this feature to OFF. Or you can set this feature to ERROR and the guidance will prompt you only when fax reception fails (see page 69).
- When the unit receives fax documents automatically, the voice guidance will not be played.

Memory reception

When a printing problem is detected, the unit will temporarily store the received document into memory.

While documents are in memory, the unit will:

- display an error message and the following message alternately:

Display: **FAX IN MEMORY**

— alert you with a slow beep (Receive alert).

- Follow the instructions on pages 93 and 94 to clear the problem and print the stored document.
- For memory capacity, see page 106.

To stop reception

Press **STOP**.

Operating the answering device

Listening to recorded messages

When the unit receives voice messages;

- the NEW MESSAGES indicator will flash,
- the call counter will show the total number of recorded messages, and
- a slow beep will sound if message alert (page 67) is set to ON.

■ To listen to new messages

Press **NEW MESSAGES**.

■ To listen to all messages

Open the station key panel, then press **ALL MESSAGES**.

Note:

- During playback, the display shows the recorded order of the messages.
- Adjust the speaker volume using **VOLUME**.
- The number of calls in the call counter will not reset until you erase your message.

Voice time/day stamp:

During playback, a synthesized voice will announce the time and day when each message was recorded.

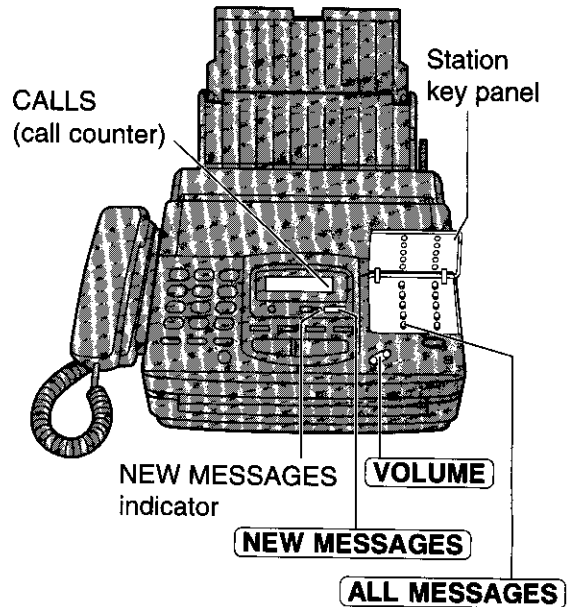

Erasing recorded messages

Erase unnecessary messages to prevent memory from becoming full.

■ To erase specific messages

Press **ERASE** while listening to the message you want to erase.

- 3 beeps will sound and following message is displayed.

Display: STOP=CANCEL

To stop erasing, press **STOP** during 3 beeps.

■ To erase all messages

1. Press **ERASE** after listening to all of the messages.

Display: CLEAR MESSAGES?

YES: PRESS SET

- To stop erasing, press **STOP**.

2. Press **START/COPY/SET**.

ERASING

ERASE COMPLETED

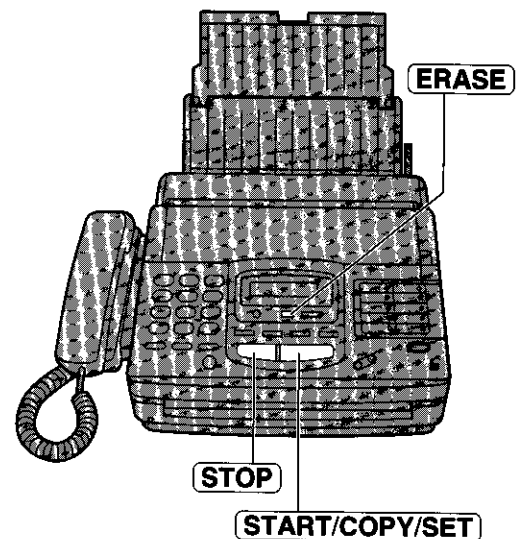

Pre-recorded greeting messages

The unit has pre-recorded greeting messages. According to the situation, one of the following messages will be played to the caller.

- When you do not record your own greeting message (page 47), the following message will be played.

*Hello! We are unable to answer right now.
To send a fax, please start transmission.
To leave a voice message, please speak after the beep.
Thank you.*

- When the unit detects a problem, one of the following pre-recorded greeting messages will be played.

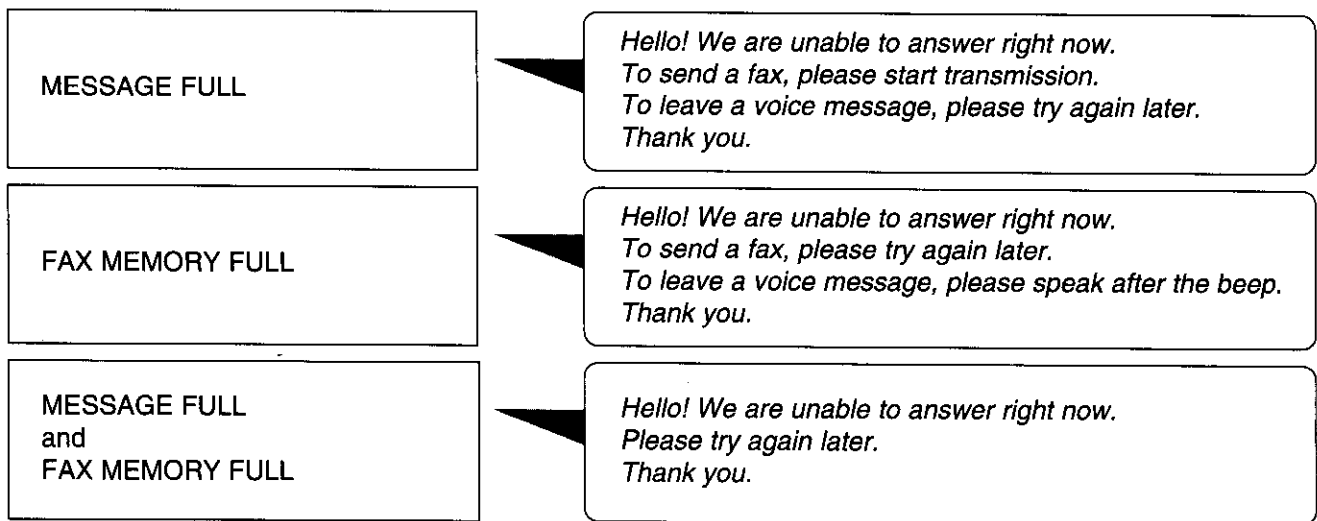

Note:

- If you erase your own greeting messages, the pre-recorded greeting messages will play automatically.

Operating the answering device (cont.)

Recording a memo message

To leave a private message for someone, you can record a voice memo. This memo can be played back later, either directly or remotely.

- 1 Open the station key panel.
- 2 Press **MEMO/2WAY REC**.
 - A long beep will sound.
- 3 Speak clearly into the microphone.
- 4 When finished, press **STOP**.

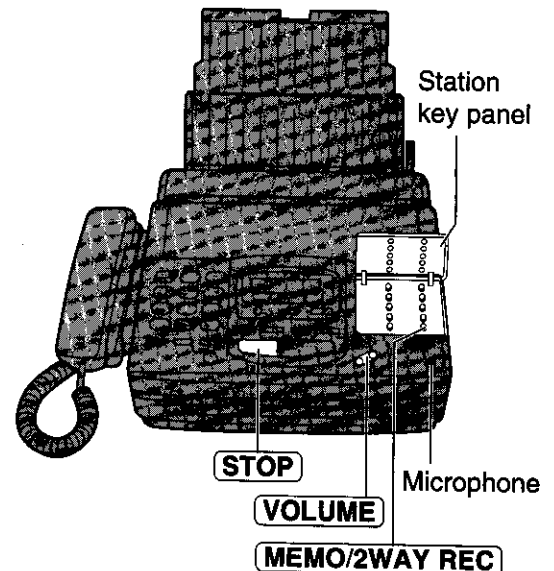

Recording a telephone conversation

- 1 During the telephone conversation, open the station key panel.
- 2 Press **MEMO/2WAY REC**.

Display: 2WAY RECORDING
- 3 To stop recording, press **STOP** or hang up.

Note:

- All persons using this device for recording telephone conversations shall comply with New Zealand law. This requires that at least one party to the conversation is to be aware that it is being recorded. In addition, the Principles enumerated in the Privacy Act 1993 shall be complied with in respect to the nature of the personal information collected, the purpose for its collection, how it is used and what is disclosed to any other party.

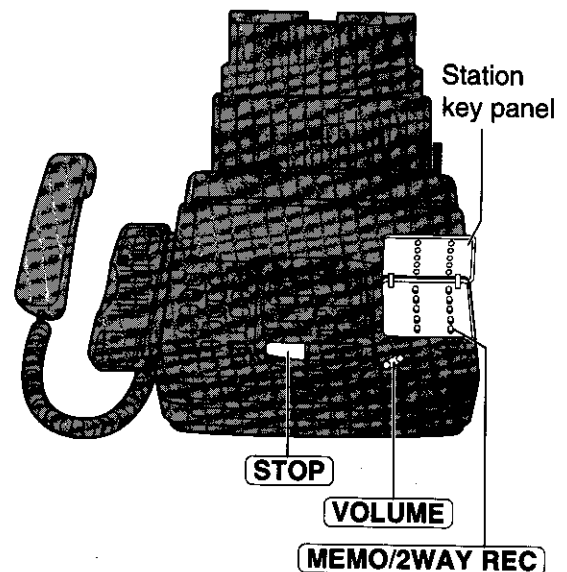

Setting the answering device volume

Press **VOLUME** (**▼**/**▲**) while listening to the recorded messages.

- 9 levels (high to off) are available.

Functions during playback

■ To repeat a message

Press **REPEAT** while listening to the message you want to repeat.

- If you press **REPEAT** within 5 seconds of the beginning of the message, the previous message will be played.
- To play back a specific message, press **REPEAT** repeatedly until you hear the message you want to repeat.
- When you want to repeat the new messages, press **NEW MESSAGES** first, open the station key panel and press **REPEAT**.

■ To skip a message

Press **SKIP** to play the next message.

- When you want to skip the new messages, press **NEW MESSAGES** first, open the station key panel and press **SKIP**.

■ To change the playback speed

Press **QUICK** to play messages at one and a half times the original speed.

Press **SLOW** to play messages at a half the original speed.

To return to the original speed:

Press **QUICK** or **SLOW** again during quick or slow playback.

■ To stop playback

Press **STOP**.

- To resume the new recorded messages, press **NEW MESSAGES** within 1 minute after pressing **STOP**.
- To resume all of the recorded messages, press **ALL MESSAGES**.

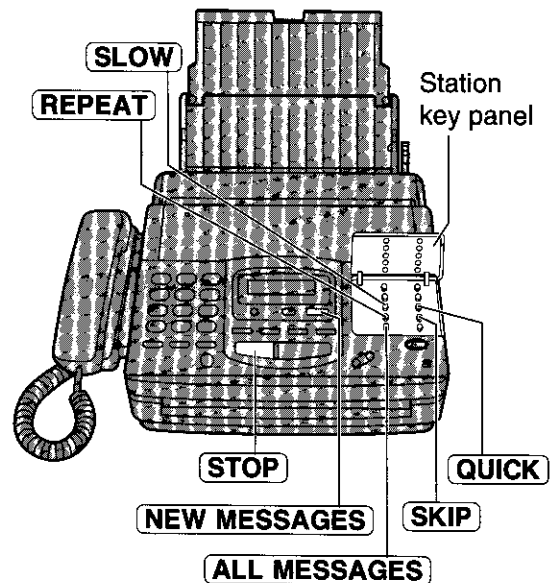

TEL/FAX mode

(automatic voice and fax recognition)

Use this mode when you wish to receive voice calls with rings, but do not want to hear the unit ring when faxes are received.

When a call is received, the unit will work as follows:

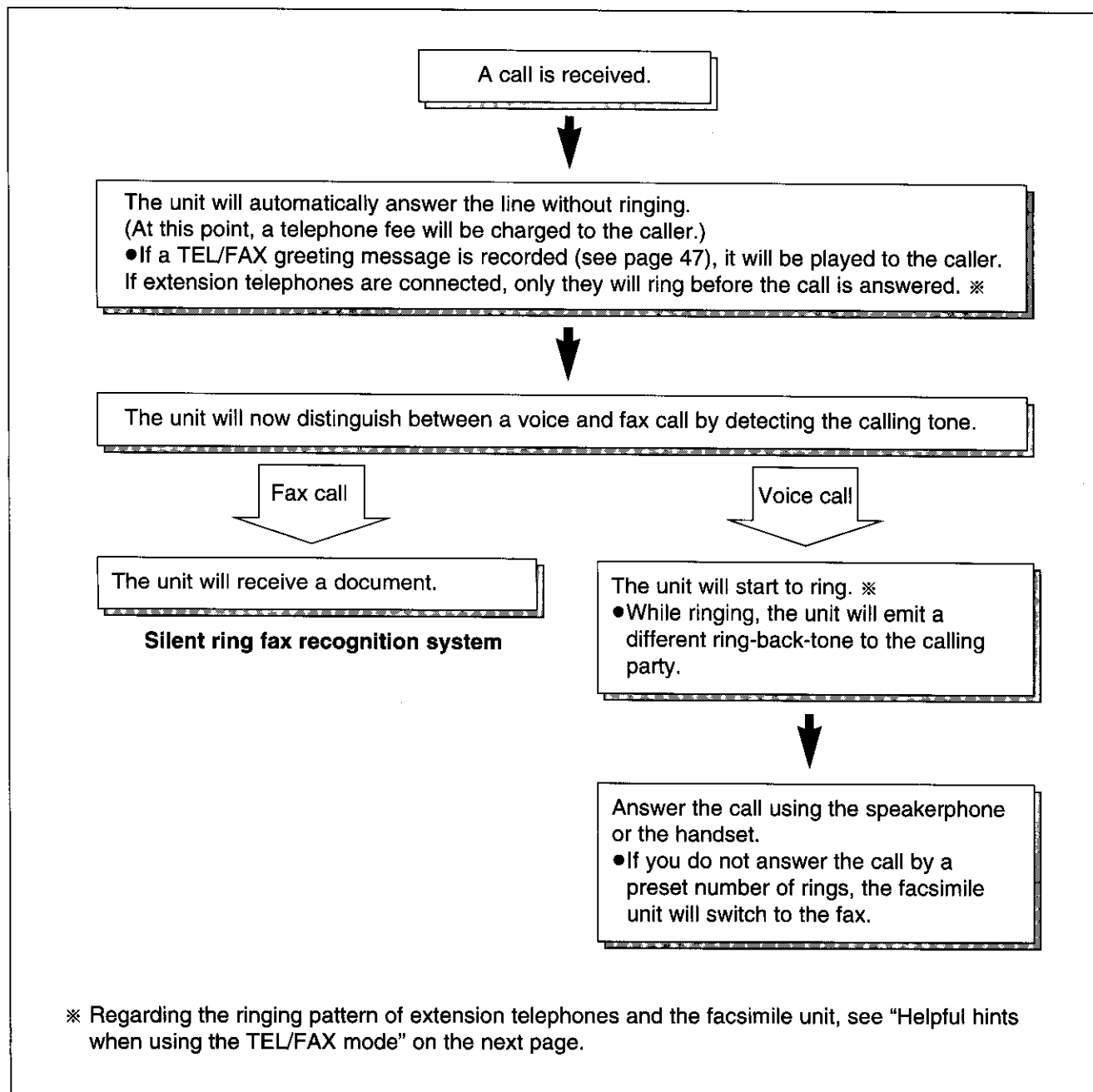

Note:

- Some fax messages that are transmitted manually may not send a calling tone. These calls must be received manually.

Special receiving modes

FAX mode (receiving fax documents only)

When you turn on the AUTO RECEIVE mode set to FAX, the unit works as a dedicated facsimile machine. The unit will automatically answer all calls and generate fax tones to the callers.

Changing the AUTO RECEIVE mode setting

Change the AUTO RECEIVE setting from the ANS/FAX mode to the FAX mode.

- 1 Press **MENU**.
Display: SYSTEM SET UP
- 2 Press **#**, then **0** **5**.
AUTO RECEIVE
- 3 Press **START/COPY/SET**.
MODE=ANS/FAX [▼▲]
- 4 Press ▼ or ▲ to select FAX.
MODE=FAX [▼▲]
•To return to the ANS/FAX mode, select ANS/FAX.
- 5 Press **START/COPY/SET**.
- 6 Press **MENU**.

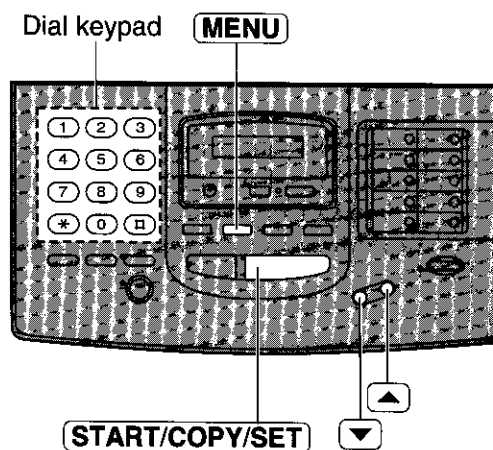

Setting the FAX mode

Press **AUTO RECEIVE** until the FAX/MSG.SYS. indicator light goes on.

- The display shows the following message:

Display: FAX MODE

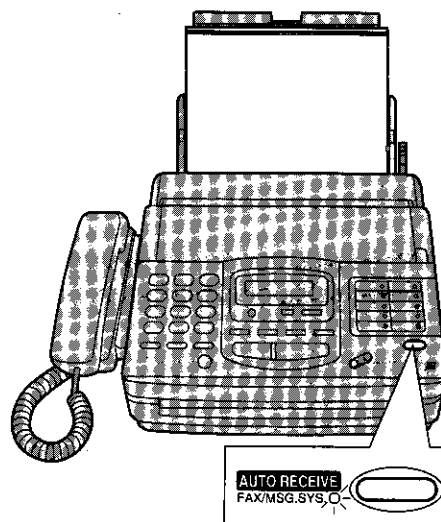

The FAX/MSG.SYS. indicator is on.

TEL/FAX mode (cont.)

Using the TEL/FAX mode

- 1** Record the TEL/FAX mode greeting message (see page 47).
 - The TEL/FAX mode greeting message will be played to the caller when the unit automatically answers an incoming call.
- 2** Set the MANUAL RECEIVE mode to TEL/FAX (see page 31).
- 3** Make sure that the AUTO RECEIVE mode is turned off.
 - If the FAX/MSG.SYS. indicator light is on, press **AUTO RECEIVE** to turn off the AUTO RECEIVE mode.
 - The display shows the following message:

Display: TEL/FAX MODE

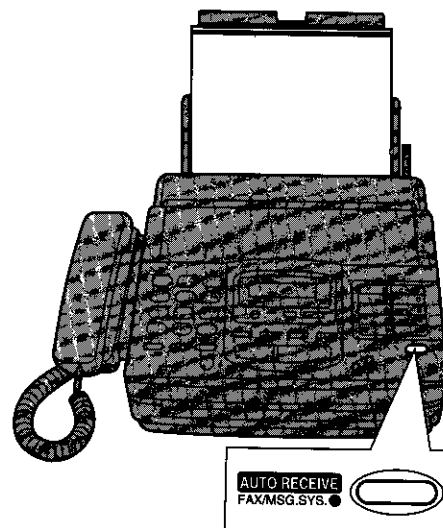

The FAX/MSG.SYS. indicator is off.

Helpful hints when using the TEL/FAX mode

- If an extension telephone is connected, the facsimile unit and the extension telephone will ring as follows.

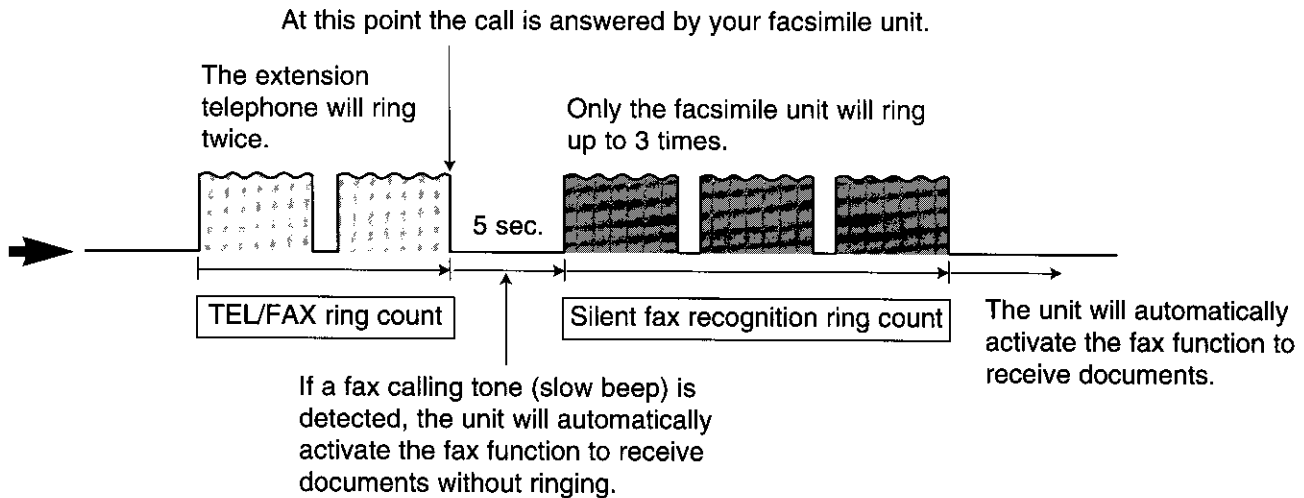

Note:

- You can change the number of rings for the TEL/FAX ring count (see page 61) and silent fax recognition ring count (see page 62). If you answer from an extension phone on the same line during the TEL/FAX ring count, you will need to press your remote activation code to receive faxes (see page 44).

Setting the TEL/FAX mode

Change the MANUAL RECEIVE setting from the TEL mode to TEL/FAX mode.

- 1 Press **MENU**.
Display: SYSTEM SET UP
- 2 Press **#**, then **0** **8**.
MANUAL RECEIVE
- 3 Press **START/COPY/SET**.
MODE=TEL [▼▲]
- 4 Press ▼ or ▲ to select TEL/FAX.
MODE=TEL/FAX [▼▲]
- To return to the TEL mode, select TEL.
- 5 Press **START/COPY/SET**.
- 6 Press **MENU**.

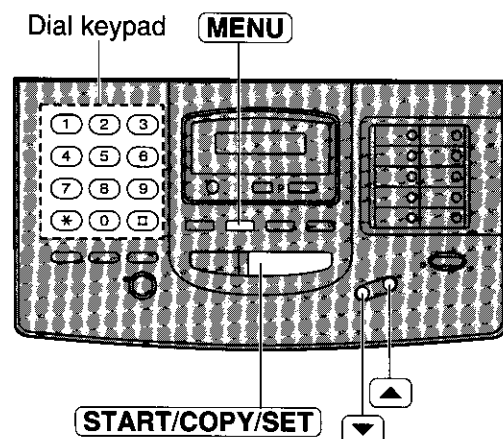

Making voice calls using automatic dialing

1 Press **DIGITAL SP-PHONE** or lift the handset.

2a Using one-touch dialing:

For upper stations (1–9)

Press the desired direct call station key.

For lower stations (10–18)

Press **LOWER**, then press the desired direct call station key.

2b Using speed dialing:

Press **DIRECTORY**, then press **#** and the desired 2-digit number (00–99).

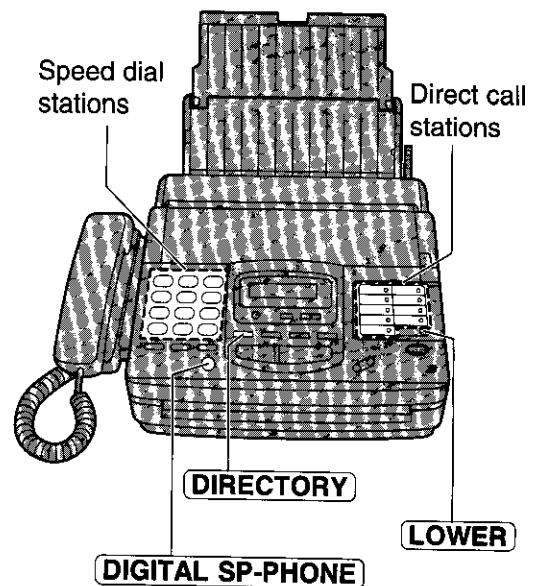

Transmitting documents using automatic dialing

1 Insert the documents **FACE DOWN**.

2a Using one-touch dialing:

For upper stations (1–9)

Press the desired direct call station key.

For lower stations (10–18)

Press **LOWER**, then press the desired direct call station key.

2b Using speed dialing:

Press **DIRECTORY**, then press **#** and the desired 2-digit number (00–99).

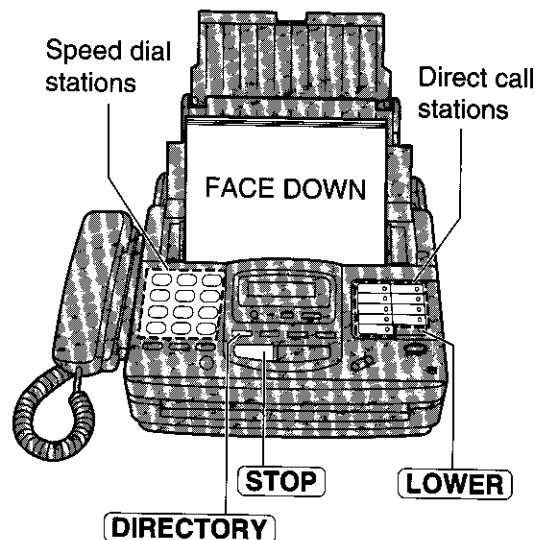

Fax auto redial

If there is no answer or the line is busy, the unit will automatically redial the number up to 2 times.

This feature is available for;

—receive polling (p. 38)

—delayed transmission (p. 39)

During auto redial, the display shows:

Display: **WAITING REDIAL**

To cancel redialing, press **STOP**.

Automatic dialing

Storing telephone numbers for automatic dialing =

The unit's memory allows you to use both one-touch dialing and speed dialing for rapid access to your most frequently dialed numbers.

One-touch dialing: 18 stations (Each of the 9 direct station keys is divided into an upper station and a lower station).

- The direct call station 1 key can be used as direct call station 1 (DIAL MODE) or as a broad cast key (PROG. MODE). Both functions cannot be used at the same time.

Speed dialing: This unit is equipped with 100 additional dialing stations. These stations are assigned to 2-digit numbers (00–99).

1 Press **MENU** until the following message is displayed.

Display:

2a **One-touch dialing:**

For upper stations (1–9)

Press one of the direct call station keys.

- If you select direct call station 1, select "DIAL MODE" by pressing **▼**, then press **START/COPY/SET** to go to the next prompt.

For lower stations (10–18)

Press **LOWER**, then press one of the direct call station keys.

2b **Speed dialing:**

Press **#**, then press the desired 2-digit number (00–99).

3 Enter the telephone number up to 30 digits in length.

- To enter a hyphen in a telephone number, press **HYPHEN** (direct call station 8).

4 Press **START/COPY/SET**.

5 Enter the station name, up to 10 characters, by following the instructions on page 14.

6 Press **START/COPY/SET**.
•To program other stations, repeat steps 2a (or 2b) to 6.

7 Press **STOP**.

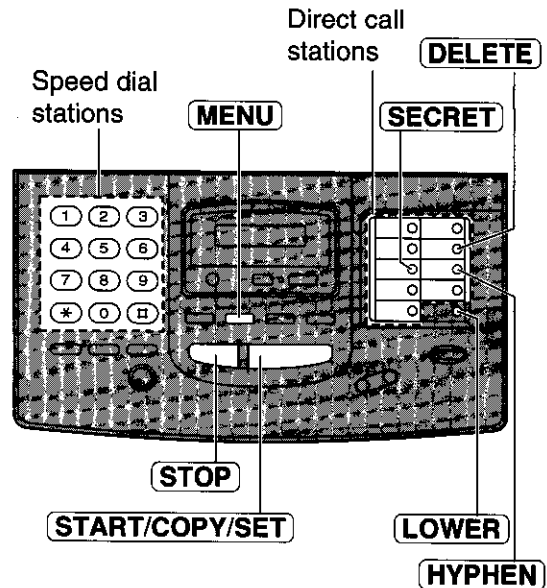

Helpful hint:

- To confirm stored telephone numbers and station names, print a telephone number list (see page 74).

To keep the telephone number confidential

Press **SECRET** (direct call station 3) after entering the telephone number.

- The telephone number will not appear on the display or the telephone number list.
- SECRET** is not counted as a digit.

To erase a stored number and station name

Press **STOP** in step 3 to erase the telephone number. Press **DELETE** (direct call station 7) repeatedly in step 5 until all of the characters are erased.

Then press **START/COPY/SET**.

Telephone

Voice contact (talking to the caller during or after fax reception or transmission)

You can have a conversation with the same call after the fax message is completed. This will save the extra expense and time of making another call.

This feature works only when the other party's unit is equipped with a voice contact feature.

Initiating voice contact

- 1 Press **DIGITAL SP-PHONE** while transmitting or receiving documents.

Display: VOICE STANDBY

- Your unit will call the other party with a distinctive ring.

- 2 When the other party answers, your unit will emit a distinctive ring.

Press **DIGITAL SP-PHONE** or lift the handset to start talking.

- If you initiate voice contact during transmission, you can talk after all of the documents have been transmitted.
- If you initiate voice contact during reception, you can talk after the current page of the document is received.

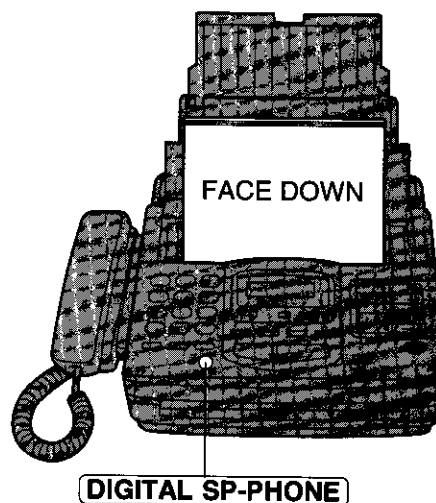

Receiving a request for voice contact

If the other party initiates voice contact, your unit will emit a distinctive ring after transmission or reception is completed.

When the distinctive ring is heard, press **DIGITAL SP-PHONE** or lift the handset, then start talking.

Note:

- If you do not answer within 10 seconds of the distinctive ring;
 - if in the ANS/FAX mode, your unit will play back a greeting message and record an incoming voice message.
 - if in the TEL/FAX, FAX or TEL mode, the line will be disconnected.

Electronic telephone directory (selecting a station name in the directory)

The station names stored in memory are automatically registered into the electronic telephone directory in alphabetical order. You can make a fax or voice call by selecting the desired station name on the display.

If you wish to send a fax, insert the documents into the document tray first.



1 Press **DIRECTORY**.

Display: SELECT INDEX

2 Press the dial key that corresponds to the first initial of the desired station name (see the index table below).

Example: To search a name starting with "N":
Press **6** until the first station name starting with "N" is displayed. Press  until the desired name is displayed.

OR

Press  or  repeatedly until the desired name is displayed.

3 Press **START/COPY/SET**.

- The unit will start dialing.
- If a document is fed into the unit, the unit will start transmission.

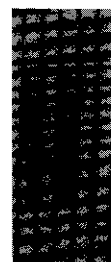
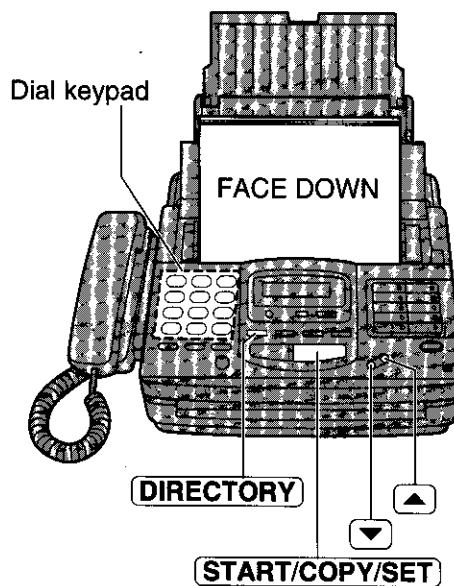

Dial key	Index	Dial key	Index
1	1	7	P, Q, R, S, 7
2	A, B, C, 2	8	T, U, V, 8
3	D, E, F, 3	9	W, X, Y, Z, 9
4	G, H, I, 4	0	0
5	J, K, L, 5	*	Other symbols
6	M, N, O, 6	□	(Used for speed dialing.)

Special sending features

Polling (retrieving fax documents)

The polling feature allows you to receive a document from another compatible machine where you pay for the call. This saves the sending party the call charges.

Receive polling

To place a call and recover a document from another machine follow the steps below. Make sure that no documents have been fed into your unit and that the other party's machine is ready for your call.

- 1 Press **MENU** until the following is displayed:

Display:

- 2 Press **START/COPY/SET**.

- 3 Enter the telephone number by using regular dialing, one-touch dialing, speed dialing or the electronic telephone directory.

- 4 Press **START/COPY/SET**.

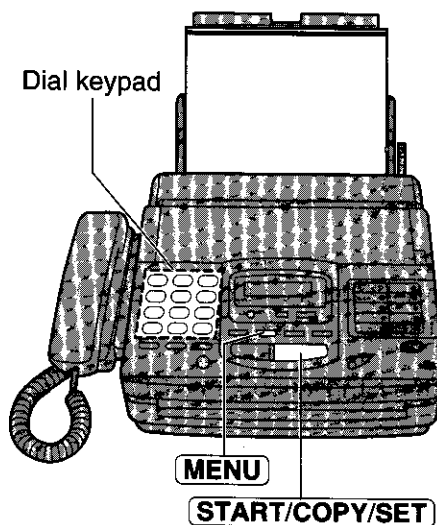

Transmit polling

A document stored in your unit can be recovered by another party's machine. To let other machines retrieve documents loaded on your unit, proceed as follows:

- 1 Insert the documents FACE DOWN.

- 2 Press **MENU** until the following is displayed:

Display:

- 3 Press **START/COPY/SET**.

[▼▲]

- 4 Press ▼ or ▲ to select "ON".

[▼▲]

• If this feature is not required, select "OFF".

- 5 Press **START/COPY/SET**.

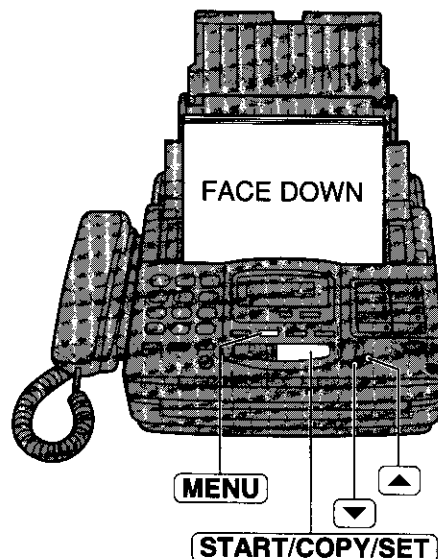

Note:

- This feature will not work when the unit is set to the TEL mode.
- The caller pays for the document transmission.
- When delayed transmission (see the next page) is set to ON, transmit polling is not available.

RECALL and REDIAL/PAUSE buttons

RECALL button

The RECALL button allows you to use special features of the host exchange (if connected) or local telephone company services such as call waiting. For further details, contact the supplier or your local telephone company.

Redialing the last number dialed

If the REDIAL/PAUSE button is pressed immediately after a dial tone is obtained, the last number dialed will be redialed.

1. Lift the handset or press **DIGITAL SP-PHONE**.
2. Press **REDIAL/PAUSE**.
 - If the line is busy when using the DIGITAL SP-PHONE button, the unit will automatically redial the number up to 2 times.

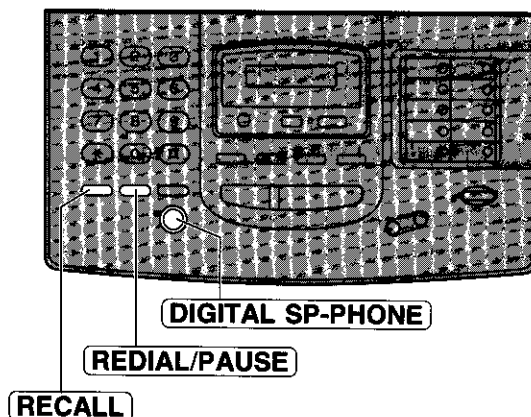

Note:

- RECALL and PAUSE can be stored into a telephone number for automatic dialing.

Entering pauses

If the REDIAL/PAUSE button is pressed during dialing, a pause will be inserted.

Example-1: When your unit is connected to a host exchange, insert a pause to get an outside line.

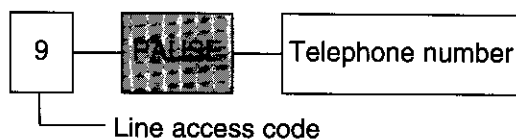

Example-2: If transmission errors occur when making an overseas transmission, add two pauses at the end of the telephone number.

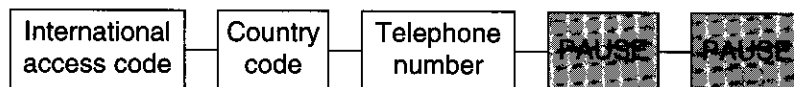

Transmitting documents from memory

The unit is able to scan and store documents into memory, and then transmit the stored documents. The memory capacity is approx. 25 pages (14 pages if the Error Correction Mode on page 73 is set to ON), based on CCITT No. 1 test chart in standard resolution. For the CCITT No. 1 test chart, see page 106.

Setting the memory transmission

- 1 Press **MENU**.
Display: **SYSTEM SET UP**
 - 2 Press **#**, then **1** **5**.
MEMORY XMT
 - 3 Press **START/COPY/SET**.
MODE=OFF [▼▲]
 - 4 Press ▼ or ▲ to select "ON".
MODE=ON [▼▲]
- If this feature is not required, select "OFF".
- 5 Press **START/COPY/SET**.
 - 6 Press **MENU**.

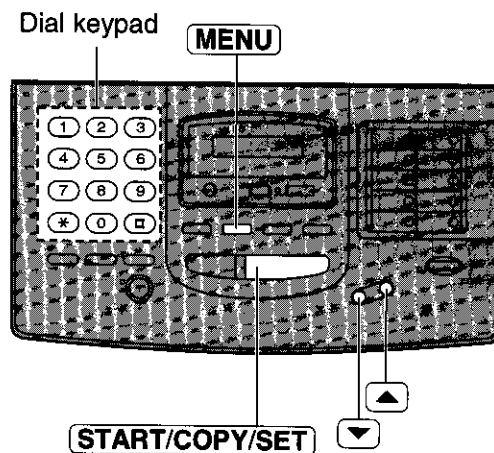

Transmitting documents from memory

- 1 Insert the documents **FACE DOWN**.
- 2 Enter the telephone number by using regular dialing, one-touch dialing, speed dialing or the electronic telephone directory.
- 3 When using regular dialing, press **START/COPY/SET**.
 - The documents will be fed into the unit and scanned into memory. After storing all pages, the unit will transmit the documents.
 - The amount of memory used will be shown as a percentage on the display.

Display: **PAGES=01** **05**
Amount of memory used

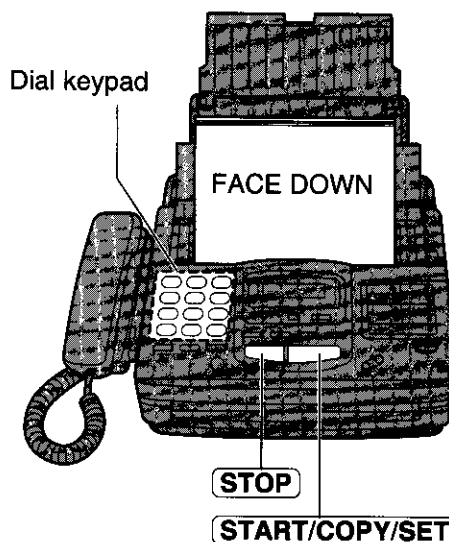

Note:

- The stored documents will be automatically erased after transmission.
- To cancel the memory transmission, press **STOP** during or after scanning the documents.
- If you select the fine, super fine or halftone resolution, the number of documents that can be sent will be decreased.
- If the stored documents exceed the memory capacity, the transmission will be canceled.

Delayed transmission

(sending a fax at a later time)

Using a built-in clock, this unit can send documents automatically at a specific time. This allows you to take advantage of low-cost calling hours offered by your telephone company. The delayed transmission can be reserved to take place up to 24 hours in advance.

1 Insert the documents FACE DOWN.

2 Press **MENU**.

Display: SYSTEM SET UP

3 Press **#**, then **2** **5**.

DELAYED XMT

4 Press **START/COPY/SET**.

MODE=OFF [▼▲]

5 Press ▼ or ▲ to select "ON".

MODE=ON [▼▲]

•If this feature is not required, select "OFF".

6 Press **START/COPY/SET**.

NO. =

7 Enter the telephone number by using regular dialing, one-touch dialing, speed dialing or the electronic telephone directory.

8 Press **START/COPY/SET**.

TIME=12:00AM

9 Enter the transmission start time.

Example: 11:00PM

Press **1** **1** **0** **0**, then press ***** to select PM.

•You can select AM or PM by pressing *****.

10 Press **START/COPY/SET**.

11 Press **MENU**.

SEND AT 11:00PM

•When the programmed time has arrived, the unit will automatically start transmission.

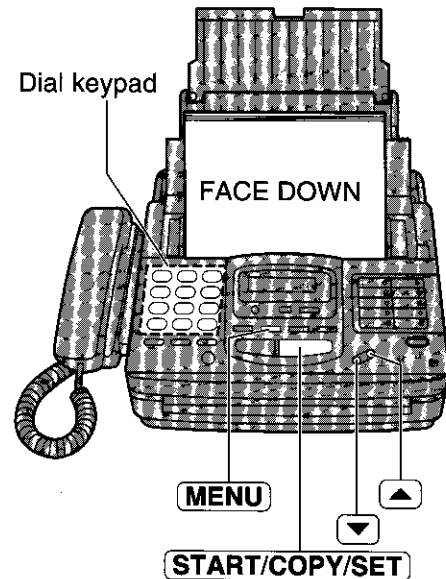

Note:

- You can receive, transmit and copy documents while delayed transmission is set.
- If the programmed time is during a power failure, delayed transmission will be attempted soon after power is restored.
- When transmit polling (see page 38) is ON, delayed transmission is not available.

Transmitting documents to multistations (cont.)

Transmission using the BROADCAST key

The documents will be scanned and stored into memory when using the BROADCAST key. After transmission, the stored documents will be erased automatically.

The memory capacity is approx. 25 pages (14 pages if the Error Correction Mode on page 73 is set to ON), based on CCITT No. 1 test chart in standard resolution. For the CCITT No. 1 test chart, see page 106.

1 Insert the documents FACE DOWN.

2 Press **BROADCAST**.

- The documents will be fed into the unit and scanned into memory. Then the unit will transmit the data to each station, calling each number sequentially.

Note:

- If you select the fine, super fine or halftone resolution, the number of documents that the unit can transmit will be decreased.
- If one of the stations is busy or does not answer, the station will be skipped. All skipped stations will be redialed up to 2 times after all of the other stations have been called.

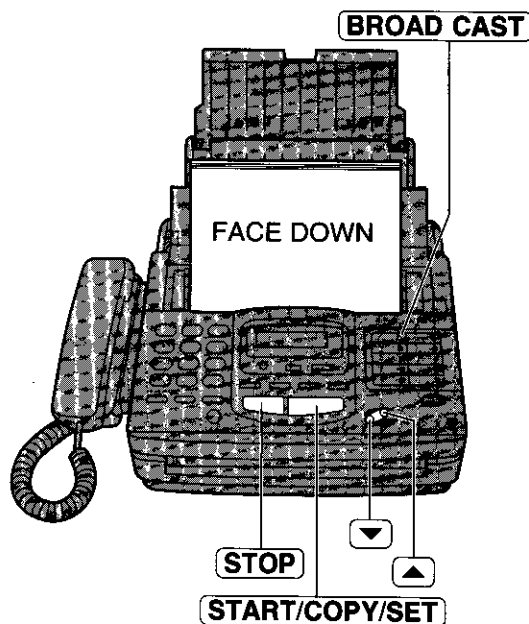

Cancelling the broadcast setting

1. Press **STOP** during idle status.

Display: CANCEL BROAD.

2. Press **START/COPY/SET**.

=YES [▼▲]

3. Press ▼ or ▲ to select "YES".

4. Press **START/COPY/SET**.

Multi Transmission report

After all of the transmissions have been completed, the unit will automatically print the following report.

Sample of a Multi Transmission report:

MULTI TRANSMISSION REPORT						(1/1)
						Jan. 10 1997 03:36PM
NO.	OTHER FACSIMILE	START TIME	USAGE TIME	TX PAGES	RESULT	
001	<S02>	Jan. 10 03:31PM	01'10	02	OK	
002	<S03>	Jan. 10 03:33PM	01'08	02	OK	
003	<S04>	Jan. 10 03:34PM	01'09	02	OK	
004	<A05>	Jan. 10 03:35PM	01'10	02	OK	
TOTAL			004'37	008		

Transmitting documents to multistations

This feature is useful when frequently sending the same documents to selected parties whose telephone numbers are stored in direct call stations and speed dial stations. You must program these stations into the BROADCAST key (direct call station 1).

Important:

- Before programming, make sure that the desired telephone numbers have been stored into the direct call stations or speed dial stations.
- The BROADCAST key can be used as direct call station 1 or as the broadcast key.

Programming the BROADCAST key with telephone numbers

1 Press **MENU** until the following is displayed:

Display: STORE TEL NO.

2 Press **BROADCAST**.

DIAL MODE [▼▲]

3 Press ▼ or ▲ to select "PROG. MODE".

PROG. MODE [▼▲]

4 Press **START/COPY/SET**.

NO. = [001]

5 Enter the telephone numbers.

a: Using direct call stations:

For upper stations 2–9, press the preset direct call station key.

For lower stations 10–18, press **LOWER**, then press the preset direct call station key.

b: Using speed dial stations:

Press **#** and the preset 2-digit number (00–99).

- To enter other telephone numbers, repeat this step (up to 117 stations).

6 Press **START/COPY/SET** after entering all of the desired telephone numbers.

7 Press **STOP**.

Note:

- If you make a mistake while programming, press **STOP**, then make the correction.
- Confirm that you have correctly stored the numbers by printing a telephone number list (see page 74).

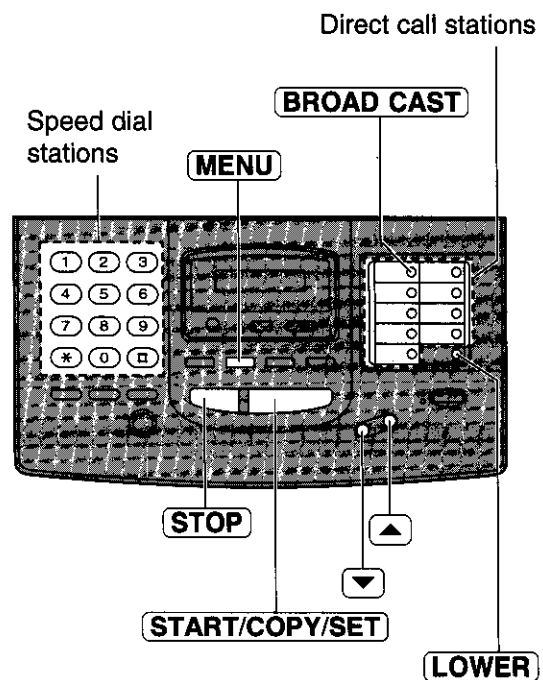

Special receiving features

Remote fax receiving (using an extension telephone to receive a fax message)

If you have an extension telephone on the same line and answer the call before your facsimile unit does, it is still possible to receive a fax message. Use the extension telephone to dial the remote fax activation code. This saves you from going to the facsimile unit and pressing **START/COPY/SET**.

Important:

- To activate this feature, use a touch tone telephone as the extension telephone and enter the remote fax activation code **FIRMLY**.
- The remote fax activation code is set to “*9” as a pre-selected setting.

Receiving using an extension telephone

- 1 When a call is received, lift the extension telephone handset.
- 2 When:
 - document reception is required,
 - a slow beep is heard, or
 - no sound is heard,enter the remote fax activation code **FIRMLY**.
- 3 Hang up the handset.
 - The facsimile unit is activated for reception.

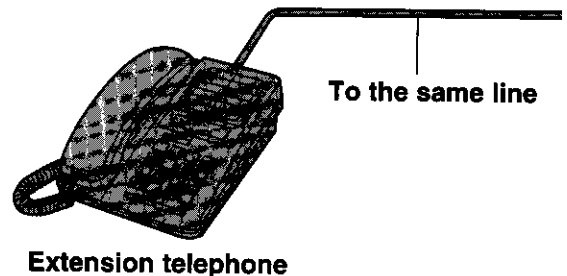

Changing the remote fax activation code

This code can be from 2 to 4 digits in length using numbers 0 through 9, and the character *.

- 1 Press **MENU**.
Display: SYSTEM SET UP
- 2 Press **#**, then **4** **1**.
REMOTE FAX ACT.
- 3 Press **START/COPY/SET**.
MODE=ON [▼▲]
- 4 Press ▼ or ▲ to select the desired setting.
 - If this feature is not required, select “OFF”.
- 5 Press **START/COPY/SET**.
CODE=*9
- 6 Enter the new code number.
- 7 Press **START/COPY/SET**.
- 8 Press **MENU**.

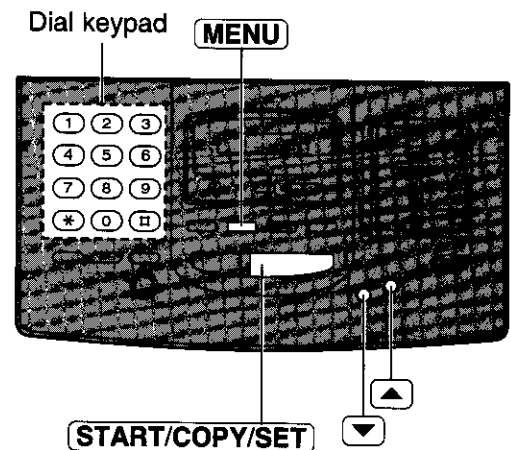

Note:

- Some special telephone company services will require you to press a service access code. If you subscribe to such services, all or part of the remote fax activation code must be different from the service access code.
- If the remote fax activation code is set to “0000”, this feature will not work properly.

Reserving transmission during fax reception

While the unit is receiving documents, you can reserve your fax transmission to another station. The unit will automatically transmit documents after fax reception is completed.

1 Insert the documents **FACE DOWN** during fax reception.

2 Enter the telephone number by using regular dialing, one-touch dialing, speed dialing or the electronic telephone directory.

3 Press **START/COPY/SET**.

Display: XMT RSV. ON

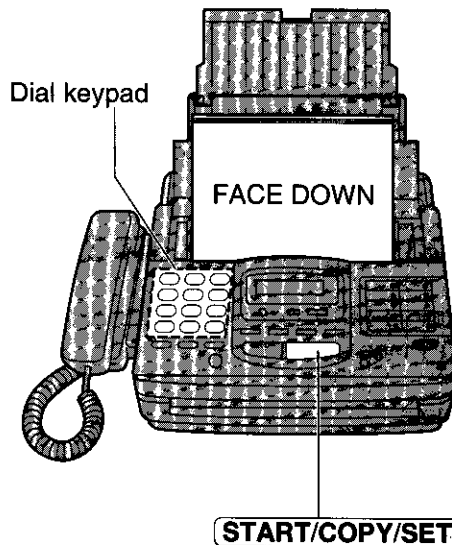

To cancel the reservation

Remove the documents from the document tray.

Printing a cover page

The unit can print a cover page to attach to the documents you send.

Sample of a cover page

[FAX COVER PAGE]

TO : NAME : _____ DATE : _____
 FAX NO. : _____

FROM : NAME : _____
 FAX NO. : _____

Number of Pages : _____ (including cover page)

Subject / Notes : _____

1 Press **MENU** until the following is displayed.

Display: PRINT LIST

2 Press **#**, then **7**.

FAX COVER PAGE

3 Press **START/COPY/SET** to start printing.

PRINTING

4 Press **MENU**.

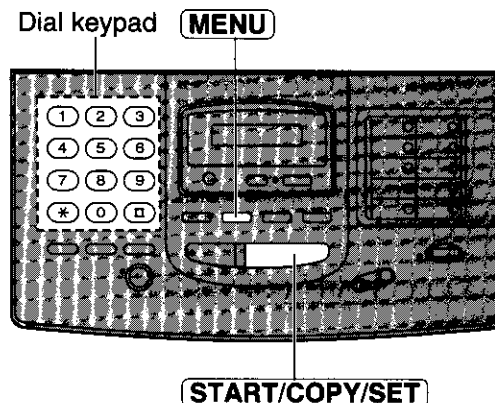

Receiving with a distinctive ring service (FaxAbility)

Note for users in New Zealand: Telecom have called this service "FaxAbility". This feature is only for use if you subscribe to a distinctive ring pattern service from their telephone company. For more information on the availability of this service in your area, please contact your telephone company before setting this feature on your unit.

The distinctive ring service gives you an additional phone number on a single telephone line, with a different ringing pattern.

When you wish to use the additional phone number as a facsimile telephone number, set the ring pattern detection feature to ON. When the unit detects a call matching the distinctive ring pattern, the unit will automatically activate depending on the receive mode setting.

To use this feature properly, set the unit to the TEL/FAX or ANS/FAX mode.

Setting the ring pattern detection

- 1** Press **MENU**.
Display: SYSTEM SET UP
- 2** Press **#**, then **3** **1**.
RING DETECTION
- 3** Press **START/COPY/SET**.
MODE=OFF [▼▲]
- 4** Press ▼ or ▲ to select "ON".
MODE=ON [▼▲]
•If this feature is not required, select "OFF".
- 5** Press **START/COPY/SET**.
PRINTING
•The unit will print an information list.
- 6** Press **MENU**.

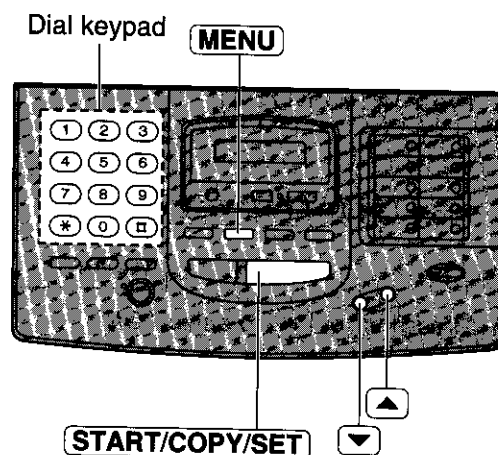

How the unit will answer in each receive mode

- **ANS/FAX mode:** When a distinctive ringing pattern is detected, the unit will automatically answer the line and activate the fax function to receive documents.
If a standard ringing pattern is received, the unit will activate the fax function or the answering system depending on the call.
- **TEL/FAX mode:** When a distinctive ringing pattern is detected, the unit will automatically answer the line and activate the fax function to receive documents.
If a standard ringing pattern is received, the unit will ring until you answer the call.
- **TEL mode:** In this mode, you have to answer all calls manually.
- **FAX mode:** In this mode, the unit will answer all calls and activate the fax function.

Note:

- The unit automatically answers a distinctive ring call after the second ring. To change the number of rings, change the FAX mode ring count (see page 60) after setting the ring pattern detection.

Junk mail prohibitor

(preventing the reception of unwanted fax documents)

This feature prevents reception from facsimile machines whose telephone numbers are not stored in one-touch dialing and speed dialing.

Store the telephone numbers from where you want to receive documents (see page 33).

Important:

- This feature does **not** work when:
 - manual reception is performed, or
 - the other party does not program their facsimile telephone number correctly.

Setting the junk mail prohibitor

- 1 Press **MENU**.
Display: SYSTEM SET UP
- 2 Press **#**, then **2** **4**.
JUNK MAIL PROH.
- 3 Press **START/COPY/SET**.
MODE=OFF [▼▲]
- 4 Press ▼ or ▲ to select "ON".
MODE=ON [▼▲]
- 5 Press **START/COPY/SET**.
PRINTING

• If this feature is not required, select "OFF".

- The unit will print a list of the telephone numbers from where the unit can receive documents. Confirm that the desired facsimile numbers are programmed.

- 6 Press **MENU**.

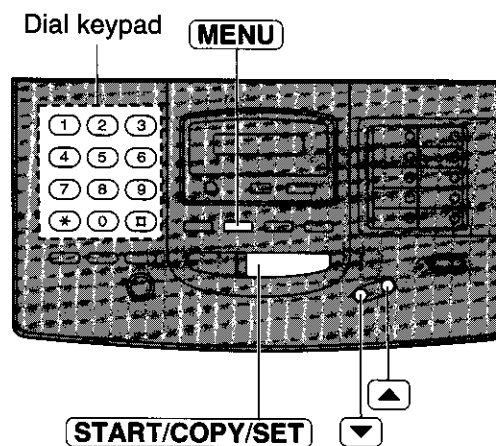

Recording your own greeting messages (cont.)

Checking the greeting messages

- 1 Open the station key panel.
- 2 Press **SELECT** until the desired greeting is displayed.

Example: ANS/FAX greeting

Display: ANS-GREETING

- 3 Press **CHECK**.
 - After the beep, the unit will play back the message. Adjust the volume using **VOLUME**.

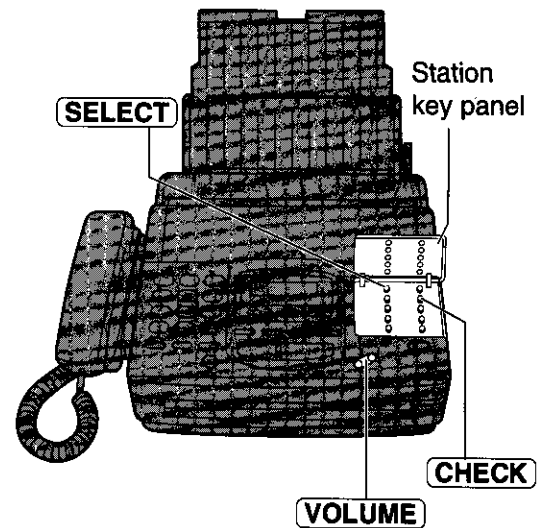

Erasing your own recorded greeting messages

- 1 Open the station key panel.
- 2 Press **SELECT** until the desired greeting is displayed.

Example: Message transfer greeting

Display: TRNS-GREETING

- 3 Press **ERASE**.

ERASE OK?

YES:PRESS SET

- 4 Press **START/COPY/SET**.

GREETING ERASED

- 5 Press **STOP**.

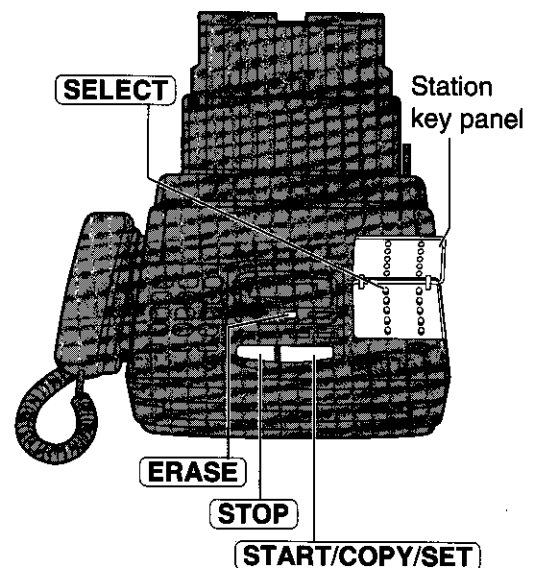

Note:

- If you erase your own recorded greeting messages, the pre-recorded greeting messages will be played.

Answering device

Recording your own greeting messages

The recording time is limited to 16 seconds for each message. Record your message within 12 seconds for optimum performance.

- As for the ANS/FAX greeting message, you can choose either 16 seconds or 60 seconds of recording time (see page 70).

Suggested messages

ANS/FAX greeting message	<i>"This is (your name, business and/or telephone number). We are unable to answer right now. To send a fax, start transmission. To leave a message, speak after the beep. Thank you."</i>
TEL/FAX greeting message	<i>"This is (your name, business and/or telephone number). Please wait for someone to answer your call. To send a fax, start transmission."</i>
Message transfer greeting message	<i>"This is a transferred message from (your name, business and/or telephone number). Please enter your remote ID for remote operation."</i>

Note:

- If you do not record any messages, pre-recorded messages will be played (see pages 25 and 49).

Recording a greeting message

- 1 Open the station key panel.
- 2 Press **SELECT** until the following is displayed.
 - For the ANS/FAX greeting:
Display:
 - For the TEL/FAX greeting:
 - For the message transfer greeting:
- 3 Press **REC**.
 - A long beep will sound.
- 4 Speak clearly 20 cm (8 inches) away from the microphone.
 - The display will show the elapsed recording time.
Example: ANS/FAX greeting
- 5 When finished, press **STOP**.
 - The unit will repeat your message. Adjust the volume using **VOLUME**.

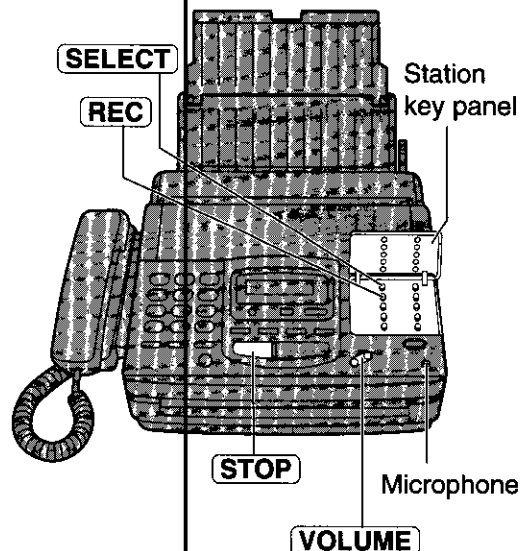

Note:

- If you make a mistake while recording, repeat from step 2.

Transferring incoming call messages (cont.)

Setting the message transfer/pager call

- 1 Press **MENU**.
Display: SYSTEM SET UP
- 2 Press **#**, then **6 0**.
MESSAGE TRANSFER
- 3 Press **START/COPY/SET**.
MODE=OFF [▼▲]
- 4 Press ▼ or ▲ to select the desired setting.
MESSAGE: transfers incoming messages.
PAGER: calls your pager.
OFF: turns off this feature.
- 5 Press **START/COPY/SET**.
NO. =
- 6 **a: If you selected "MESSAGE" in step 4:**
Enter the transfer telephone number.
b: If you selected "PAGER" in step 4:
Enter your pager number.
 - If this feature does not work properly, press **REDIAL/PAUSE** more than once at the end of your pager number to extend the paging time.

If you wish to display a message on your pager, enter the message after your pager number and **REDIAL/PAUSE**.
Programming methods may vary depending on the pager company. Call your pager company for details.
 - You may enter a total of 46 digits and/or pauses.
- 7 Press **START/COPY/SET**.
- 8 Press **MENU**.

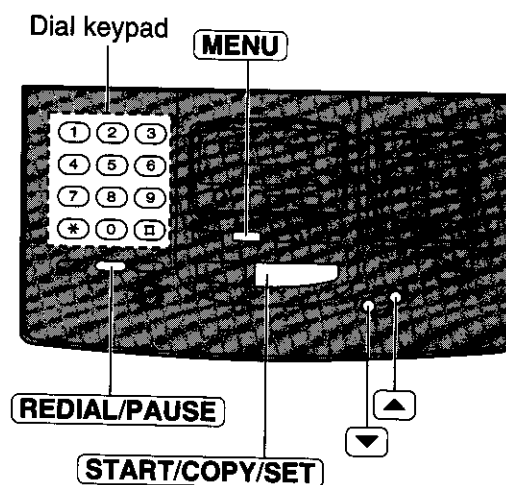

Note:

- This feature can be turned on/off remotely from a touch tone telephone (see page 55).

Transferring incoming call messages

This feature allows your unit to call a designated telephone or pager number each time an incoming voice message is recorded.

You can choose **Message transfer** or **Pager call**.

Message transfer: Program the transfer telephone number first. When an incoming message is recorded in your unit, the message will be transferred. You can retrieve the message during the same call by the remote operation.

Pager call: Program the pager number first. When an incoming call is recorded, your pager will be called. Call your unit and retrieve the message by the remote operation.

- This feature operates in the ANS/FAX mode.
- For details on the remote operation, see page 51.
- Use a touch tone telephone to access your unit.

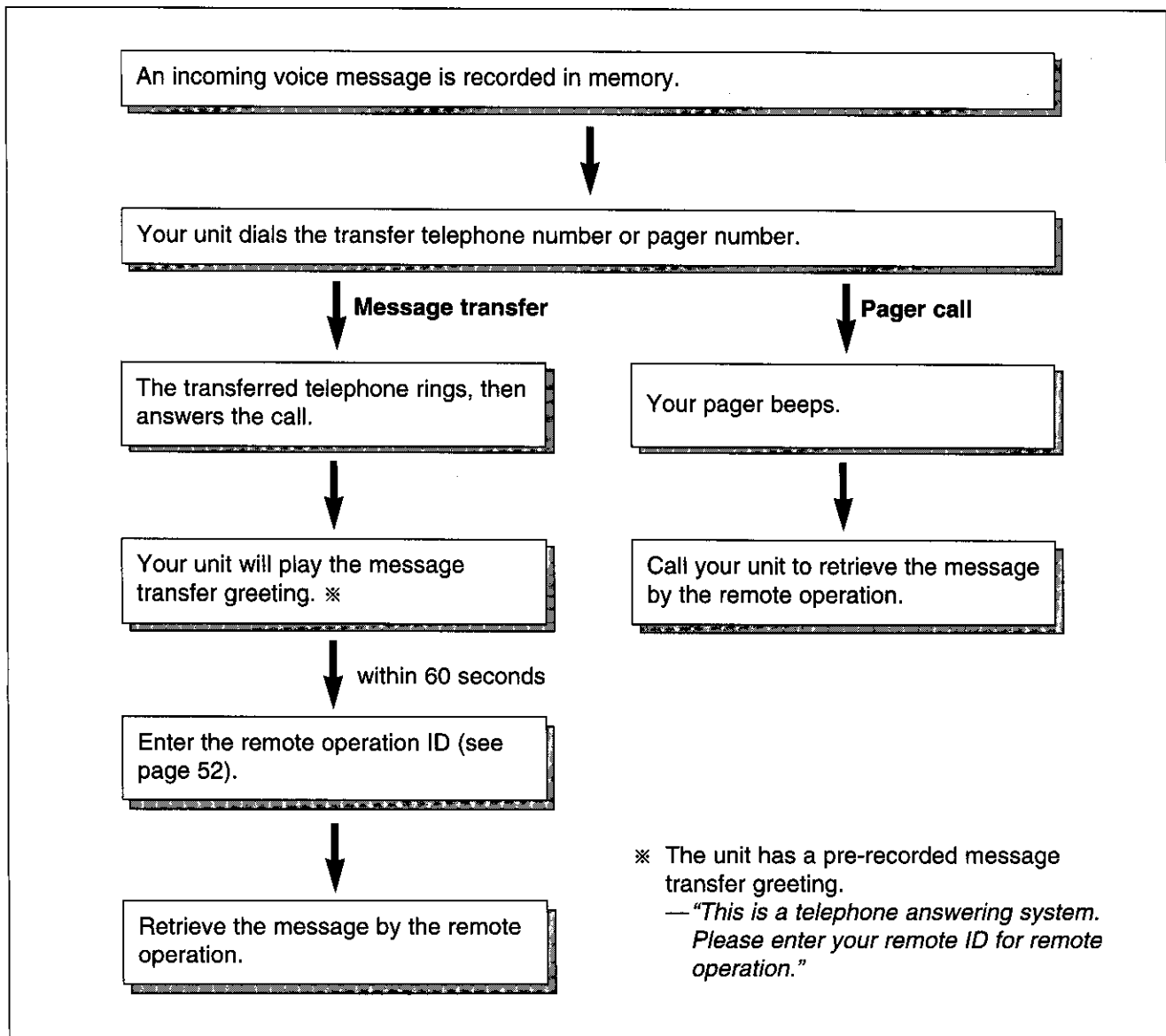

Operating the answering device from a remote telephone (cont.)

Programming the remote operation ID

The remote operation ID is used to access the answering device. Choose any 3-digit number except a number using digits 0 or 7.

- 1 Press **MENU**.
Display: SYSTEM SET UP
- 2 Press **#**, then **1 1**.
REMOTE ANS ID
- 3 Press **START/COPY/SET**.
ID=111
- 4 Enter the desired number.
- 5 Press **START/COPY/SET**.
- 6 Press **MENU**.

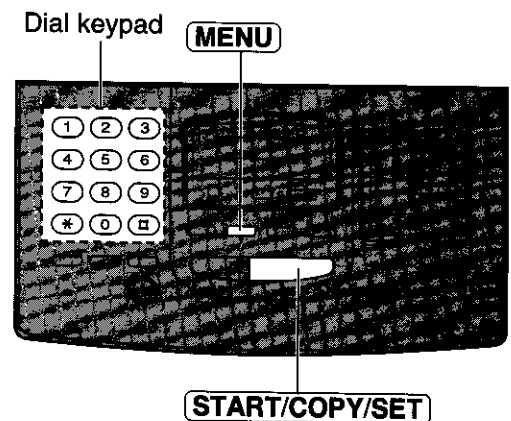

Key	Remote Command
0	Skips the greeting message
1	Repeats a message
2	Skips a message
4	New message playback
5	All message playback
7	Re-records a greeting message

Key	Remote Command
9	Stops re-recording of a greeting message
*4	Erases a specific message
*5	Erases all messages
80	Changes to the TEL mode
81	Message transfer/ Pager call ON
82	Message transfer/ Pager call OFF

Operating the answering device from a remote telephone

The following operations can be performed from a remote location using a touch tone telephone. Set the unit to **ANS/FAX** in the **AUTO RECEIVE** mode before going out (see page 24).

Dial key	Remote command	Page	Dial key	Remote command	Page
0	Skips the greeting message	55	9	Stops re-recording of a greeting message	55
1	Repeats a message	53	*4	Erases a specific message	54
2	Skips a message	53	*5	Erases all messages	54
4	New message playback	53	8 0	Changes to the TEL mode	55
5	All message playback	53	8 1	Turns on message transfer/ pager call for incoming messages	55
7	Re-records a greeting message	55	8 2	Turns off message transfer/ pager call for incoming messages	55

Remote operation card

Please cut out and carry this card for assistance when using the remote operation.

Answering Device Remote Operation	Notice of Remote Operation
<ol style="list-style-type: none"> Call your unit. Enter the remote operation ID <input type="text"/> <input type="text"/> <input type="text"/> during the greeting message. Press the remote command key(s) (see the reverse side) within 4 seconds. or Wait for 4 seconds. All the recorded messages will be played back. 	<ul style="list-style-type: none"> The remote operation is available only from a touch tone telephone when the unit is in the ANS/FAX mode. When the unit is in the TEL mode, call your unit and wait for 15 rings. The answering system will temporarily answer the line. Enter the remote operation ID during the greeting message. The unit will switch to the ANS/FAX mode. When you press any key, press firmly. To send a document, press *9. When a fax tone is heard, start transmission.

Operating the answering device from a remote telephone (cont.)

Erasing incoming messages from memory

■ To erase a specific message

Press ***4** while listening to the message you want to erase.

- A long beep and the voice guide will be heard. Then the unit will continue with the next message.

Voice guide example:

The message has been erased.

■ To erase all messages

Press ***5** to erase all messages.

- A long beep and the voice guide will be heard.

Voice guide example:

All messages have been erased.

Other remote operations

■ To record a marker message

After playing back the recorded messages, you can leave an additional message.

1. Wait for the voice guide to tell you that the remote operation has ended.
2. Wait about 10 seconds until the voice guide is played.
3. Leave a message after the beep.

Voice guide example:

All messages have been played.

Please leave your name and message after the beep.

Listening to messages

- 1 Call your unit.
- 2 Enter the remote operation ID during the ANS/FAX greeting playback.
—The voice guide will tell you the number of new recorded messages.
- 3 Press **[4]** to listen to the new recorded messages.
OR
Press **[5]** or wait for 4 seconds to listen to all of the recorded messages.

Voice guide example:

3 new messages.

During playback

■ To repeat a message

Press **[1]** to play the current message.

—If you press **[1]** within 5 seconds of the beginning of a message, the previous message will be played.

■ To skip a message

Press **[2]**.

Note:

- If the voice guide prompts you that memory is full after playing the message, erase some or all of the messages.

Voice guide example:

Sorry, no more memory. Please erase unnecessary messages.

Enhanced copy features

Making an extension copy

Use this feature to enlarge a document to twice the length of the paper that is currently being used in the paper tray. This feature is used to reverse the film/paper save function (see page 65).

Sample of enlarged copy:

When you wish to enlarge the top half of the document:

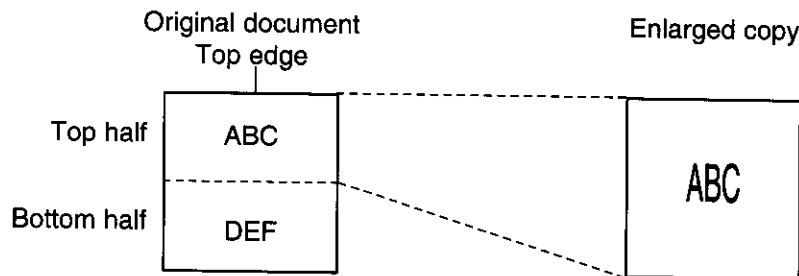

Insert the document into the unit from the top edge side
FACE DOWN.

1 Insert the documents FACE DOWN.

2 Press **MENU**.

Display: SYSTEM SET UP

3 Press **#**, then **3** **4**.

EXTENSION COPY

4 Press **START/COPY/SET**.

COPYING

•The unit will start printing.

5 After printing, press **MENU**.

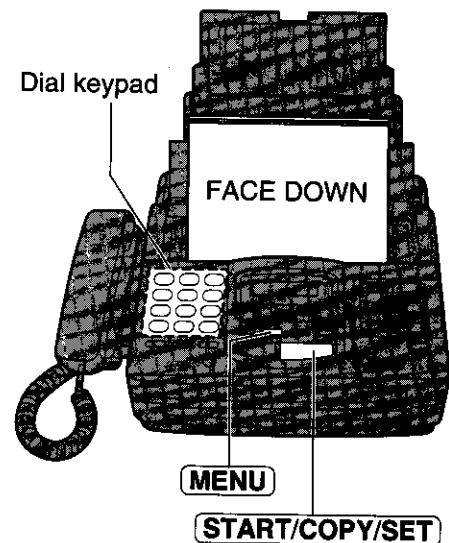

Note:

- You cannot select FINE, SUPER FINE or HALF TONE resolution for this feature.
- To make an enlarged copy of the whole page whose length is as long as, or shorter than, the installed paper, proceed as follows:
First insert the top half of the original document into the feeder tray and copy. Then turn the original around and insert the bottom half of the document into the feeder tray and copy.

■ To re-record a greeting message

You can change the contents of the greeting messages for the ANS/FAX mode.

1. Press **[7]** to start recording.
 - A long beep will sound.
2. Speak clearly up to 16 seconds.
 - If you pause for over 2 seconds, 6 beeps will sound and the recording will stop. Repeat from step 1 within 10 seconds.
3. When finished, press **[9]**.
 - The new greeting message will be played.

■ To change to the TEL mode

You can change the setting of the receive mode from ANS/FAX to TEL from a remote location.

1. Call your unit.
2. Enter your remote operation ID.
3. Press **[8] [0]**.

■ To turn the message transfer/pager call on or off

You can remotely turn this feature on or off. You must pre-program a transfer telephone number or a pager number (see page 50).

Press **[8] [1]** to turn ON the message transfer/pager call.

- The unit will activate the previous setting.

For example:

When turning this feature ON from a remote telephone, message transfer will be activated if message transfer is set to ON beforehand, or pager call will be activated if pager call is set to ON beforehand.

Voice guide example:

*Message transfer is set.
Transfer phone number is 123456789.
or
Pager call is set.
Pager number is 098765432.*

Press **[8] [2]** to turn OFF the message transfer/pager call.

*Message transfer is off.
or
Pager call is off.*

—If a transfer telephone number or a pager number is not programmed, you cannot turn this feature ON. The voice guide will prompt you.

*Transfer phone number is not set.
or
Pager number is not set.*

■ To skip the greeting message

Press **[0]** during the greeting message playback.
—The unit will skip the rest of the greeting message.

Special Settings

Summary of user programmable features

Basic features

Code	Feature	Preselected setting	Available settings	Page
#01	SET DATE & TIME			13
#02	YOUR LOGO			14
#03	YOUR TELEPHONE NUMBER			15
#04	PRINT TRANSMISSION REPORT	OFF	ERROR, ON, OFF	75
#05	AUTO RECEIVE MODE	ANS/FAX	ANS/FAX, FAX	29
#06	ANS/FAX RING COUNT	2 rings	2-9 rings, TOLL SAVER, RINGER OFF	59
#07	FAX RING COUNT	2 rings	2-9 rings	60
#08	MANUAL RECEIVE MODE	TEL	TEL, TEL/FAX	31
#09	TEL/FAX DELAYED RING	2 rings	2-9 rings	61
#10	RECORDING TIME	VOX	VOX (unlimited), 1 MIN	62
#11	REMOTE ANS ID	ID=111		52
#14	PC LINK	ON	ON, OFF	90
#15	MEMORY TRANSMISSION	OFF	ON, OFF	40

Advanced features

Code	Feature	Preselected setting	Available settings	Page
#21	LOGO POSITION	OUT	OUT, IN	63
#22	JOURNAL AUTO PRINT	ON	ON, OFF	75
#23	OVERSEAS MODE	OFF	ON, OFF	64
#24	JUNK MAIL PROHIBITOR	OFF	ON, OFF	45
#25	DELAYED TRANSMISSION	OFF	ON, OFF	39
#30	SILENT FAX RECOGNITION RING	3 rings	3-6 rings	62
#31	RING DETECTION (Faxability)	OFF	ON, OFF	46
#33	FILM/PAPER SAVE	OFF	ON, OFF	65
#34	EXTENSION COPY			56
#35	COPY REDUCTION	OFF	92%, 72%, OFF	57
#36	RECEIVE REDUCTION	92%	92%, 86%, 72%, OFF	66
#39	LCD CONTRAST	NORMAL	NORMAL, DARKER	67
#41	REMOTE FAX ACTIVATION CODE	ON/CODE=*9	ON, OFF	44
#42	MESSAGE ALERT	OFF	ON, OFF	67
#43	RECORDING TIME ALERT	OFF	ON, OFF	68
#44	RECEIVE ALERT	ON	ON, OFF	68
#46	FRIENDLY RECEPTION	ON	ON, OFF	69
#47	FAX VOICE GUIDANCE	ON	ERROR, ON, OFF	69
#54	GREETING MESSAGE RECORDING TIME	16s	16s, 60s	70
#60	MESSAGE TRANSFER	OFF	OFF, MESSAGE, PAGER	50
#67	ICM MONITOR	ON	ON, OFF	70
#70	FAX PAGER	OFF	ON, OFF	71
#79	FILM DETECTION	ON	ON, OFF	72
#80	SET DEFAULT	NO	YES, NO	73
#88	ECM COMMUNICATION	ON	ON, OFF	73

Making a reduction copy

When you copy documents that are longer than the recording paper, the unit can reduce the original document and print it out on one page by programming a suitable reduction rate. The reduction rate is determined by a combination of the size of the recording paper and original document.

■ Recommended reduction rate:

Mode	Size of recording paper	Size of original document
OFF (pre-selected)	A4	A4, Letter
92% (See note below.)	A4	A4
72%	A4	Legal

A4 = 210 × 297 mm (8¹/₄" × 11¹¹/₁₆")

Letter = 216 × 279 mm (8¹/₂" × 11"

Legal = 216 × 356 mm (8¹/₂" × 14"

To program a reduction rate, proceed as follows:

- 1 Press **MENU**.
Display: SYSTEM SET UP
- 2 Press **#**, then **3** **5**.
COPY REDUCTION
- 3 Press **START/COPY/SET**.
MODE=OFF [▼▲]
- 4 Press ▼ or ▲ to select the desired setting.
• If this feature is not required, select "OFF".
- 5 Press **START/COPY/SET**.
- 6 Press **MENU**.

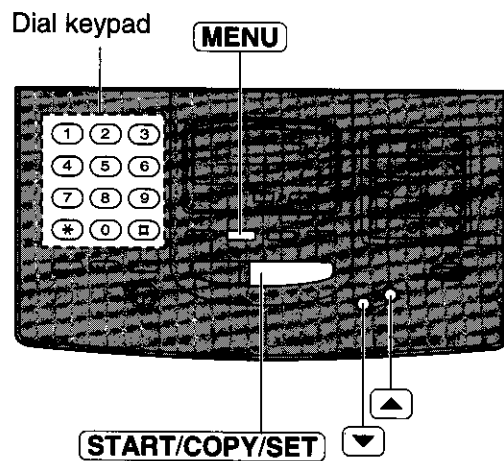

Note:

- If the appropriate reduction rate is not programmed, the document may be divided and the top of the second sheet will be deleted.
- If the image at the bottom of the document is not copied when you copy a document as long as the recording paper, try 92%.

Setting the FAX mode ring count

This feature determines the number of rings after which the unit answers a call in the FAX mode. You can choose from 2 to 9 rings.

Helpful hints:

- To answer a call before the unit does, increase the number of rings. If you answer from an extension phone on the same line, see page 44.
- If you have difficulty in receiving faxes from machines that have an automatic transmission feature, decrease the number of rings.

- 1 Press **MENU**.
Display: **SYSTEM SET UP**
- 2 Press **#**, then **0** **7**.
FAX RING
- 3 Press **START/COPY/SET**.
RING=2 [▼▲]
- 4 Press ▼ or ▲ to select the desired number.
- 5 Press **START/COPY/SET**.
- 6 Press **MENU**.

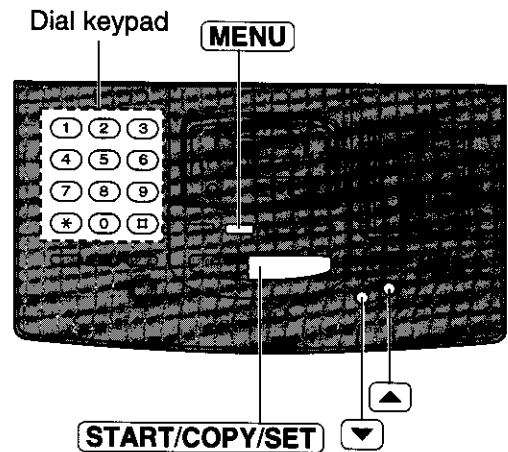

Setting the ANS/FAX mode ring count

This feature determines the number of rings after which the unit answers a call in the ANS/FAX mode. You can choose from 2 to 9, TOLL SAVER and RINGER OFF.

TOLL SAVER: When you call the unit from a remote location, the number of rings will tell you if there are any new voice messages. If the unit answers on the second ring, there is at least one new recorded message. If the unit answers on the fourth ring, there are no new recorded messages. To save the toll charges for the call, hang up immediately when you hear the third ring. The third ring indicates that there are no new messages.

RINGER OFF: The unit will answer without ringing.

Helpful hints:

- To answer a call before the unit does, increase the number of rings. If you answer from an extension phone on the same line, see page 44.
- If you find difficulty in receiving faxes from machines that have an automatic transmission feature, decrease the number of rings.

- 1 Press **MENU**.
Display: **SYSTEM SET UP**
- 2 Press **#**, then **0 6**.
ANS/FAX RING
- 3 Press **START/COPY/SET**.
RING=2 [▼▲]
- 4 Press ▼ or ▲ to select the desired number.
- 5 Press **START/COPY/SET**.
- 6 Press **MENU**.

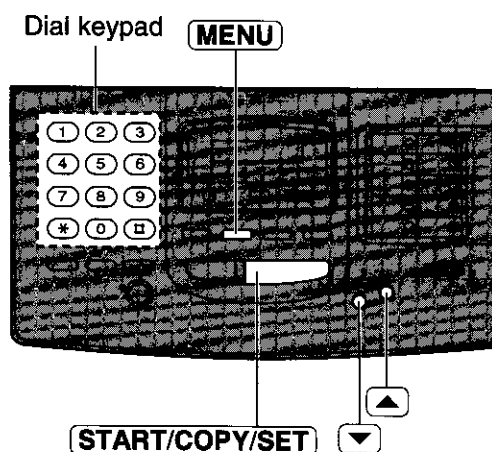

Setting the silent fax recognition ring count

When a fax call is received in the TEL/FAX mode, the unit will automatically activate the fax function without ringing. If the unit detects a voice call, it will ring. If a voice call is not answered within the selected number of rings (3 to 6 rings), the unit will switch back to the fax mode. This is for machines that do not send a calling tone.

- 1 Press **MENU**.
Display: SYSTEM SET UP
- 2 Press **#**, then **3 0**.
SILENT FAX RING
- 3 Press **START/COPY/SET**.
RING=3 [▼▲]
- 4 Press ▼ or ▲ to select the desired number.
- 5 Press **START/COPY/SET**.
- 6 Press **MENU**.

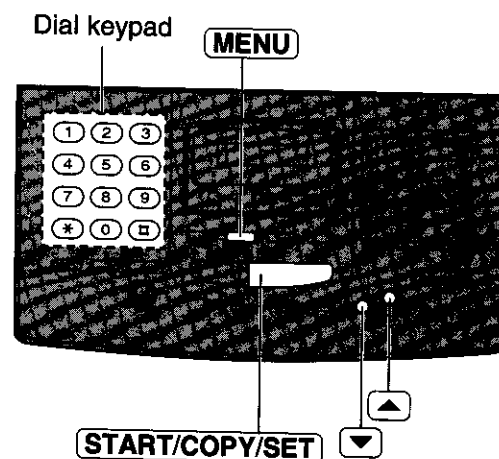

Note:

- If you increase the number of rings, you may not be able to receive documents from some older types of facsimile machines.

Changing the caller's recording time

You can choose from two lengths of recording times for an incoming message.

- VOX (unlimited):** The unit records an incoming message as long as the caller talks (pre-selected setting).
1 MIN (1 minute): The unit will record each incoming message up to 1 minute.

- 1 Press **MENU**.
Display: SYSTEM SET UP
- 2 Press **#**, then **1 0**.
RECORDING TIME
- 3 Press **START/COPY/SET**.
MODE=VOX [▲▼]
- 4 Press ▼ or ▲ to select the desired setting.
- 5 Press **START/COPY/SET**.
- 6 Press **MENU**.

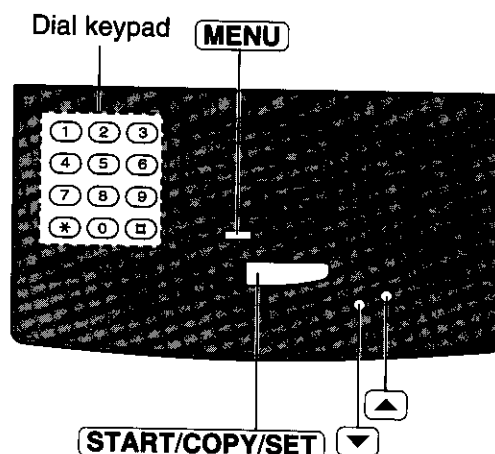

Setting the TEL/FAX mode ring count

This feature determines the number of rings after which the unit automatically answers a call in the TEL/FAX mode.

You can choose from 2 to 9 rings.

Helpful hints:

- To answer a call before the unit does, increase the number of rings. If you answer from an extension phone on the same line, see page 44.
- If you have difficulty in receiving faxes from machines that have an automatic transmission feature, decrease the number of rings.

- 1 Press **MENU**.
Display: SYSTEM SET UP
- 2 Press **#**, then **0** **9**.
TEL/FAX RING
- 3 Press **START/COPY/SET**.
RING=2 [▼▲]
- 4 Press ▼ or ▲ to select the desired number.
- 5 Press **START/COPY/SET**.
- 6 Press **MENU**.

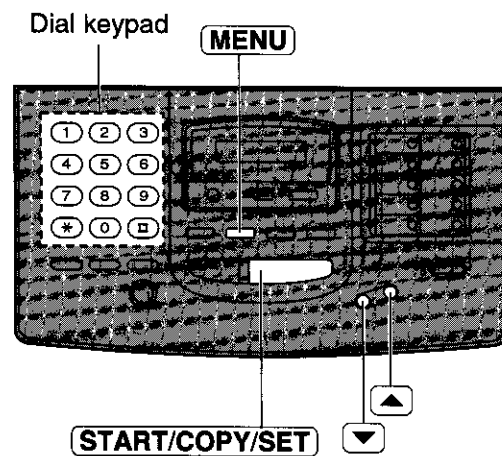

Sending documents overseas

You may experience difficulty in transmitting documents overseas. This feature makes sending documents easier as the transmission speed is slowed down. Before starting transmission, follow the steps below:

- 1 Press **MENU**.
Display: SYSTEM SET UP
- 2 Press **#**, then **2** **3**.
OVERSEAS MODE
- 3 Press **START/COPY/SET**.
MODE=OFF [▼▲]
- 4 Press ▼ or ▲ to select "ON".
MODE=ON [▼▲]
•If this feature is not required, select "OFF".
- 5 Press **START/COPY/SET**.
- 6 Press **MENU**.

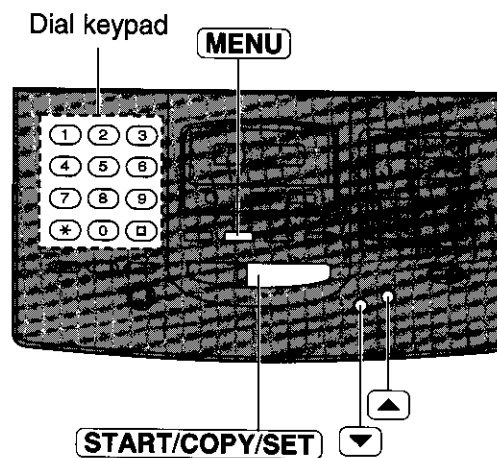

Note:

- After transmission, this feature will turn off automatically.
- This feature is not available for transmission using the BROADCAST key.

Changing the logo print position

The logo, telephone number, date, time and page number will be printed on the transmitted document from your unit in the following manner:

OUT: Outside of the transmitted document's paper size (pre-selected setting).

IN: Inside of the transmitted document's paper size.

- 1** Press **MENU**.
Display: SYSTEM SET UP
- 2** Press **#**, then **2** **1**.
LOGO POSITION
- 3** Press **START/COPY/SET**.
MODE=OUT [▼▲]
- 4** Press ▼ or ▲ to select the desired setting.
- 5** Press **START/COPY/SET**.
- 6** Press **MENU**.

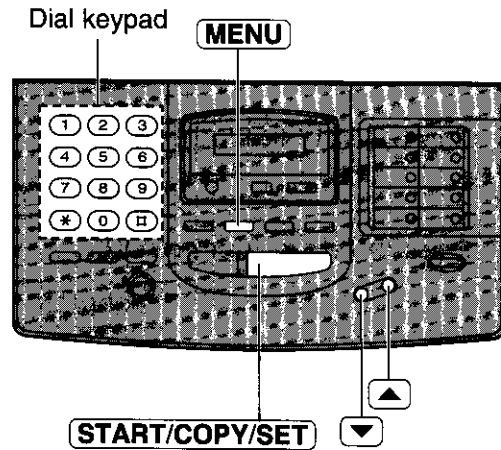

Receiving oversized documents

When the size of the documents sent by the other party is as large as or larger than the recording paper, the unit can reduce each page of the document and print it out on the recording paper by programming a suitable reduction rate.

The reduction rate is determined by a combination of the size of the recording paper and received document.

■ Recommended reduction rate:

Mode	Size of recording paper	Size of original document
OFF	A4	Letter
92% (pre-selected)	A4	A4
86% (See note below.)	A4	A4
72%	A4	Legal

A4 = 210 × 297 mm (8¹/₄" × 11¹¹/₁₆")

Letter = 216 × 279 mm (8¹/₂" × 11")

Legal = 216 × 356 mm (8¹/₂" × 14")

To program a reduction rate, proceed as follows:

- 1 Press **MENU**.
Display: SYSTEM SET UP
- 2 Press **#**, then **3** **6**.
RX REDUCTION
- 3 Press **START/COPY/SET**.
MODE=92% [▼▲]
- 4 Press ▼ or ▲ to select the desired setting.
• If this feature is not required, select "OFF".
- 5 Press **START/COPY/SET**.
- 6 Press **MENU**.

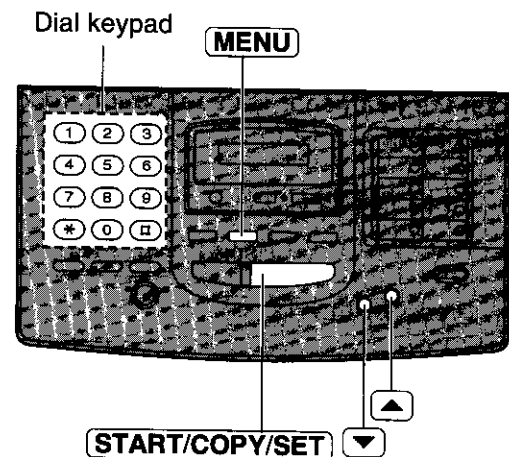

Note:

- This feature is not available when the film/paper save reception feature is set to ON (see page 65).
- Documents received by facsimile frequently have a heading on the top of each page which contains the sender's name/telephone number. This increases the length of each page. Therefore, it is recommended to use the reduction mode.
- If the appropriate reduction rate is not programmed, the document will be divided.
- If most of documents sent from the other party are as long as your recording paper and they have a long heading using a few lines, we recommend to select 86%.

Film/Paper save reception

Use this feature if you wish to save film and recording paper when receiving two or more faxed pages. When this feature is set, the unit will reduce documents to half their length and print out two pages of documents on one page. A boundary will be printed out between the documents.

Important:

- This feature will not work when the other party sends a document in fine resolution or other non-standard resolutions.

Sample of paper save print:

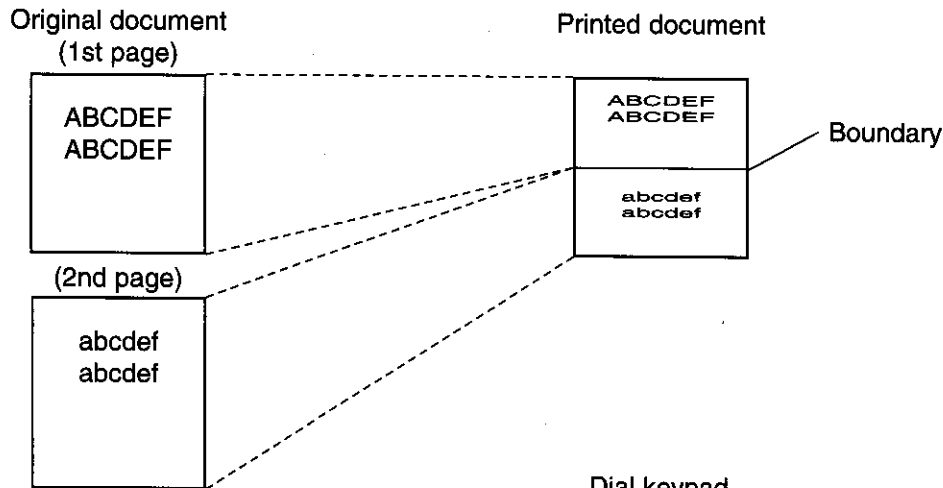

To set the film/paper save reception, follow the steps below.

- 1 Press **MENU**.
Display: SYSTEM SET UP
 - 2 Press **#**, then **3** **3**.
FILM/PAPER SAVE
 - 3 Press **START/COPY/SET**.
MODE=OFF [▼▲]
 - 4 Press ▼ or ▲ to select "ON".
MODE=ON [▼▲]
- If this feature is not required, select "OFF".
- 5 Press **START/COPY/SET**.
 - 6 Press **MENU**.
—If this feature is set to "ON", an arrow will be displayed.

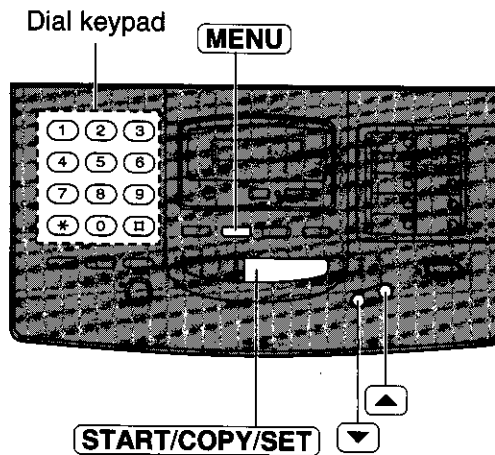

Note:

- When a reduced document is longer than the recording paper, it will be printed on two pages. The continuation will be printed on the next page and there may be wasted space. In this case, paper and film will not be saved. If you wish to fit the document onto one page, set this feature to off and program a suitable reduction rate for reception (see the next page).
- When documents are longer than legal size, the unit will not print the next page of the document on the same page.
- Paper and film will not be saved for a one page document and the last page of odd numbered documents (3, 5, 7 pages, etc.).

Setting the recording time alert

With this feature, when the remaining time to record incoming messages becomes less than 60 seconds, the unit will alert the user with a slow beep.

- 1 Press **MENU**.
Display: SYSTEM SET UP
- 2 Press **#**, then **4** **3**.
REC. TIME ALERT
- 3 Press **START/COPY/SET**.
MODE=OFF [▼▲]
- 4 Press ▼ or ▲ to select "ON".
MODE=ON [▼▲]
 - If this feature is not required, select "OFF".
- 5 Press **START/COPY/SET**.
- 6 Press **MENU**.

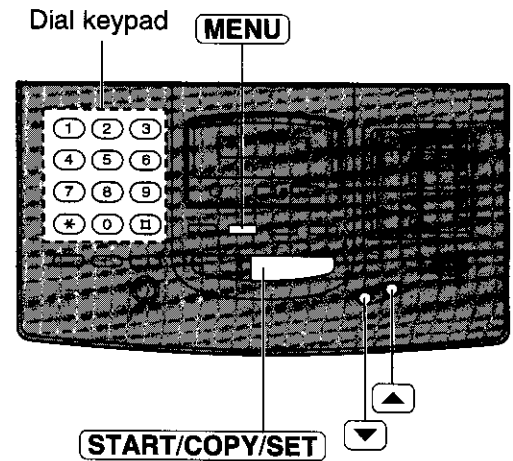

Setting the memory reception alert

When received documents are stored into memory, the unit will alert you with beep tones. If you hear slow beeps, clear the printing problem or supply paper to print the stored documents. The beep tones will stop.

- 1 Press **MENU**.
Display: SYSTEM SET UP
- 2 Press **#**, then **4** **4**.
RECEIVE ALERT
- 3 Press **START/COPY/SET**.
MODE=ON [▼▲]
- 4 Press ▼ or ▲ to select the desired setting.
 - If this feature is not required, select "OFF".
- 5 Press **START/COPY/SET**.
- 6 Press **MENU**.

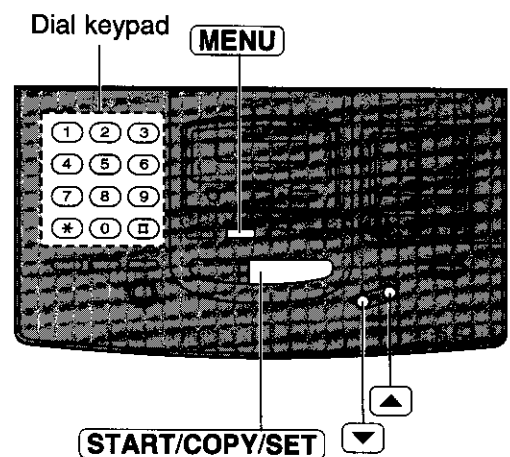

Changing the display contrast

Use this feature to adjust the brightness of the display.

NORMAL: (Pre-selected setting)

DARKER: Used when the display contrast is too light.

- 1 Press **MENU**.
Display: SYSTEM SET UP
- 2 Press **#**, then **3** **9**.
LCD CONTRAST
- 3 Press **START/COPY/SET**.
MODE=NORMAL [▼▲]
- 4 Press ▼ or ▲ to select the desired setting.
- 5 Press **START/COPY/SET**.
- 6 Press **MENU**.

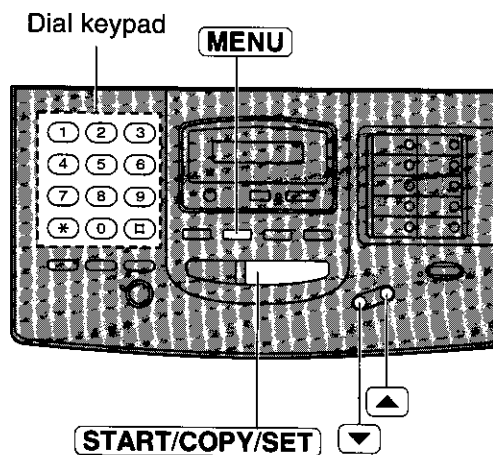

Setting the message alert

When this feature is on, the unit will let you know with a slow beep that a caller's message has been recorded.

- 1 Press **MENU**.
Display: SYSTEM SET UP
 - 2 Press **#**, then **4** **2**.
MESSAGE ALERT
 - 3 Press **START/COPY/SET**.
MODE=OFF [▼▲]
 - 4 Press ▼ or ▲ to select "ON".
MODE=ON [▼▲]
- If this feature is not required, select "OFF".
- 5 Press **START/COPY/SET**.
 - 6 Press **MENU**.

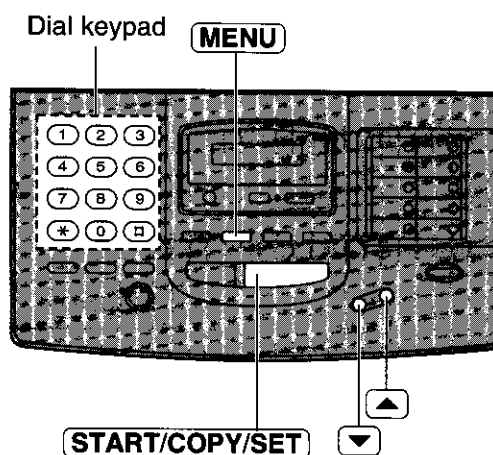

Changing the recording time for the ANS/FAX greeting message

You can choose either 16 seconds or 60 seconds of recording time.

- 1 Press **MENU**.
Display: SYSTEM SET UP
- 2 Press **#**, then **5** **4**.
GREETING TIME
- 3 Press **START/COPY/SET**.
MODE=16s [▼▲]
- 4 Press ▼ or ▲ to select the desired setting.
- 5 Press **START/COPY/SET**.
- 6 Press **MENU**.

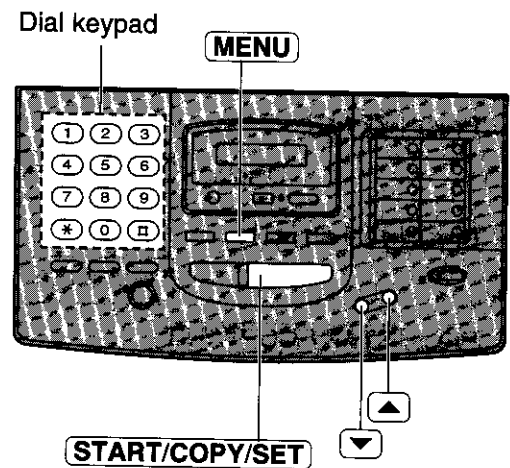

Note:

- If you change the greeting message time to 60 seconds, we recommend that you inform the caller in the ANS/FAX greeting message to press *9 before starting fax transmission.
- If you change the greeting message time to 16 seconds from 60 seconds, your recorded ANS/FAX greeting message will be deleted. Re-record a greeting message (see page 47).

Setting the ICM monitor

When a call is received with the answering device, the incoming message will be heard from the speaker during the call. If you do not wish the message to be heard by other persons who share your unit, set this feature to OFF.

- 1 Press **MENU**.
Display: SYSTEM SET UP
- 2 Press **#**, then **6** **7**.
ICM MONITOR
- 3 Press **START/COPY/SET**.
MODE=ON [▼▲]
- 4 Press ▼ or ▲ to select "OFF".
MODE=OFF [▼▲]
- If this feature is required, select "ON".
- 5 Press **START/COPY/SET**.
- 6 Press **MENU**.

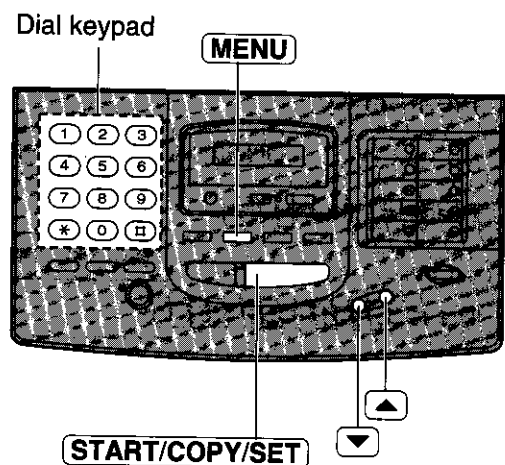

Setting the friendly reception

The friendly reception feature allows you to receive fax documents automatically without pressing **START/COPY/SET**. See page 23 for further details.

If you set this feature to OFF, you have to press **START/COPY/SET** to receive fax documents each time you answer a call.

- 1 Press **MENU**.
Display: SYSTEM SET UP
- 2 Press **#**, then **4** **6**.
FRIENDLY RCV
- 3 Press **START/COPY/SET**.
MODE=ON [▼▲]
- 4 Press ▼ or ▲ to select the desired setting.
•If this feature is not required, select "OFF".
- 5 Press **START/COPY/SET**.
- 6 Press **MENU**.

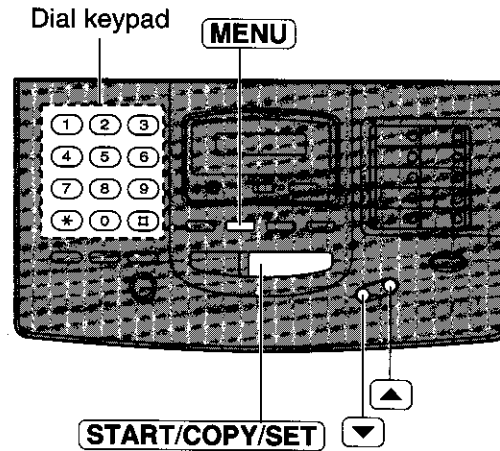

Note:

- If you set the fax voice guidance feature to OFF (see below), you cannot hear the friendly reception message.

Setting the fax voice guidance

One of the following choices is available (see pages 20 and 23).

ON: The voice guidance message regarding fax transmission/reception and friendly reception will be heard after every transaction (pre-selected setting).

OFF: The fax voice guidance will not be heard.

ERROR: The fax voice guidance will be heard only when fax transmission/reception and friendly reception fail.

- 1 Press **MENU**.
Display: SYSTEM SET UP
- 2 Press **#**, then **4** **7**.
FAX GUIDANCE
- 3 Press **START/COPY/SET**.
MODE=ON [▼▲]
- 4 Press ▼ or ▲ to select the desired setting.
- 5 Press **START/COPY/SET**.
- 6 Press **MENU**.

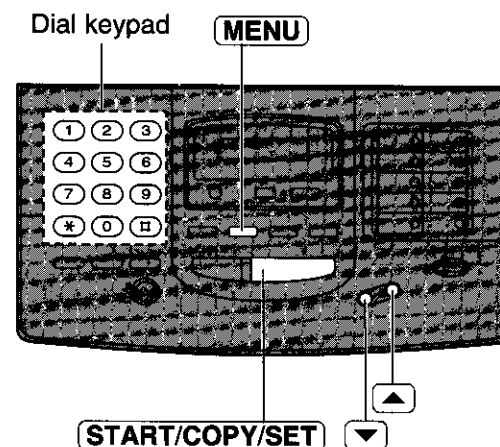

Setting the film detection

If this feature is activated, the display will show the following message when the remaining film prints approx. 10 pages of A4 size documents:

Display: FILM NEAR EMPTY

•If you are using regular film (100 m roll), the unit also prints a report.

1 Press MENU.
Display: SYSTEM SET UP

2 Press #, then 7 9.
FILM DETECTION

3 Press START/COPY/SET.
MODE=ON [▼▲]

4 Press ▼ or ▲ to select the desired setting.

•If this feature is not required, select "OFF".

5 Press START/COPY/SET.

6 Press MENU.

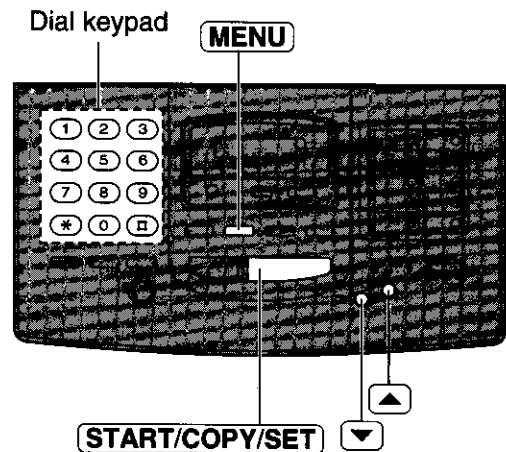

Signaling your pager that you have received a fax document

This feature allows your unit to call your pager when your unit receives a fax message.

1 Press **MENU**.
Display: SYSTEM SET UP

2 Press **#**, then **7 0**.
FAX PAGER

3 Press **START/COPY/SET**.
MODE=OFF [▼▲]

4 Press ▼ or ▲ to select "ON".
MODE=ON [▼▲]

• If this feature is not required, select "OFF".

5 Press **START/COPY/SET**.
NO. =

6 Enter your pager number.

• If this feature does not work properly, press **REDIAL/PAUSE** more than once at the end of your pager number to extend the paging time.

If you wish to display a message on your pager, enter the message after your pager number and **REDIAL/PAUSE**.

Programming methods may vary depending on the pager company. Contact your pager company for details.

• You can enter a total of 46 digits and/or pauses.

7 Press **START/COPY/SET**.

8 Press **MENU**.

Note:

• This feature is not available when the receive mode is set to the TEL mode.

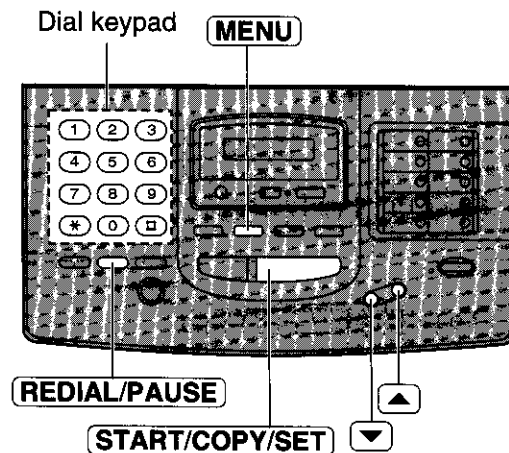

Printing reports and lists

You can print out the following reports/lists from your unit:

Feature list—provides you with the current settings of the basic and advanced programming features (see page 58).

Telephone number list—provides you with telephone numbers and their station names which are stored in automatic dialing. Telephone number codes are as shown below:

P: A pause has been entered.

F: A recall has been entered.

[]: A secret telephone number has been entered. (The telephone number is not printed.)

Journal report—keeps records of fax transmissions and receptions (see page 76 for a sample of the report). This report will be printed automatically after every 35 fax communications, but also can be printed manually. You can change the setting of the journal auto print feature (see page 75).

Printer test list—allows you to check the print quality of your unit. If the test print has a dirty pattern or blurred points or lines, clean the thermal head (see page 105).

Transmission report—provides you with a printed record of the fax transmission result (see pages 75 and 76).

How to print reports and lists

1 Press **MENU** until the following is displayed.

Display: PRINT LIST

2 For the feature list, press **#**, then **1**.

SETUP LIST

For the telephone number list, press **#**, then **3**.

TEL NO. LIST

For the journal report, press **#**, then **4**.

JOURNAL REPORT

For the printer test list, press **#**, then **5**.

PRINTER TEST

3 Press **START/COPY/SET** to start printing.

PRINTING

•To interrupt printing, press **STOP**.

4 After printing, press **MENU**.

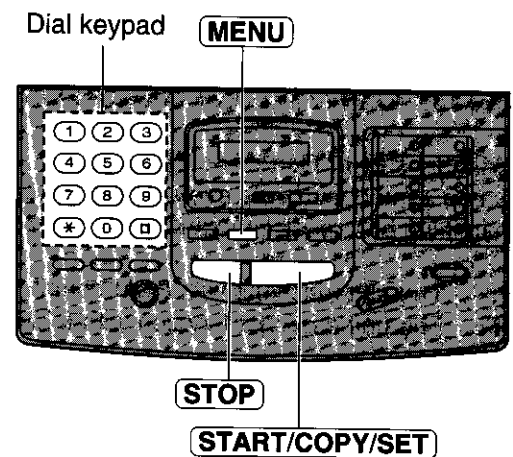

Resetting the advanced features

Use this feature to return the advanced features except the ECM communication (#88) to their initial settings (see page 58).

- 1 Press **MENU**.
Display: SYSTEM SET UP
- 2 Press **#**, then **8 0**.
SET DEFAULT
- 3 Press **START/COPY/SET**.
RESET=NO [▼▲]
- 4 Press ▼ or ▲ to select "YES".
RESET=YES [▼▲]
- 5 Press **START/COPY/SET**.
RESET OK?
- If this feature is not required, press **STOP**.
- 6 Press **START/COPY/SET** again for confirmation.
RESET COMPLETED
- 7 Press **MENU**.

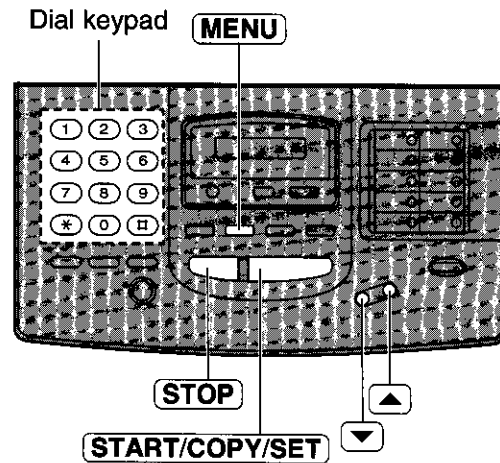

ECM communication

ECM means Error Correction Mode.

You can send documents even if there is static interference on the telephone line, provided both the transmitting and receiving stations are ECM compatible.

- ON:** The unit functions with ECM communication (pre-selected setting).
OFF: The unit does not function with ECM communication.

- 1 Press **MENU**.
Display: SYSTEM SET UP
- 2 Press **#**, then **8 8**.
ECM COMMUNI.
- 3 Press **START/COPY/SET**.
MODE=ON [▼▲]
- 4 Press ▼ or ▲ to select the desired setting.
- 5 Press **START/COPY/SET**.
- 6 Press **MENU**.

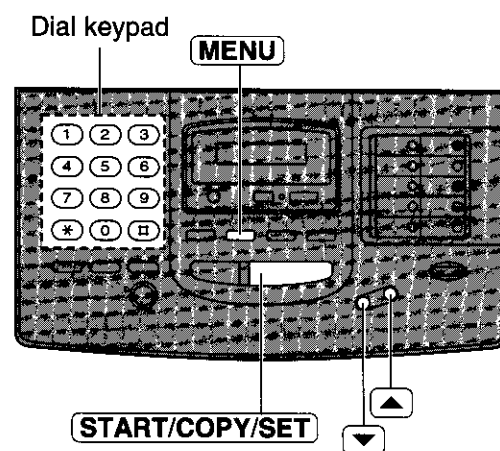

Note:

- You cannot change the setting of this feature if there are stored documents in memory. Clear the stored document memory first.

Printing reports and lists (cont.)

Journal report sample

[REDACTED]						
Jan. 25 1997 05:22PM						
NO.	OTHER FACSIMILE	START TIME	USAGE TIME	MODE	PAGES	RESULT *CODE
01	1234567	Jan. 21 02:14PM	00'25	TX	01	OK
02	9998765	Jan. 21 02:17PM	00'38	TX	02	OK
03	2121444	Jan. 21 02:18PM	00'28	RX	01	OK
04	555556677	Jan. 22 10:35AM	00'58	TX	03	COMMUNICATION ERROR (43)
05			01'50	TX	05	OK
				RX	03	OK

Communication messages
(See page 77.)

Error code
(for service personnel use only)

Transmission report sample

[REDACTED]						
Jan. 20 1997 01:19PM						
NO.	OTHER FACSIMILE	START TIME	USAGE TIME	MODE	PAGES	RESULT *CODE
01	1234567	Jan. 20 01:18PM	00'51	TX	00	COMMUNICATION ERROR (43)

Setting the transmission report printing

One of the following choices is available:

ERROR: The transmission report will print out only when fax transmission fails.

ON: The report will always print out, indicating whether fax transmission is successful or not.

OFF: The report will not print (pre-selected setting).

- 1 Press **MENU**.
Display: SYSTEM SET UP
- 2 Press **#**, then **0** **4**.
TX-REPORT MODE
- 3 Press **START/COPY/SET**.
MODE=OFF [▼▲]
- 4 Press ▼ or ▲ to select the desired setting.
- 5 Press **START/COPY/SET**.
- 6 Press **MENU**.

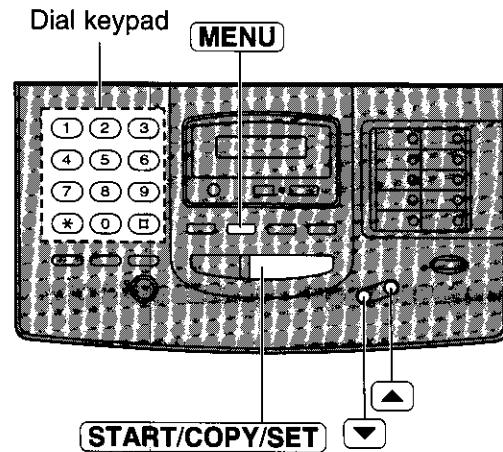

Setting the journal report to automatically print

This unit will automatically print a journal report after every 35 fax communications. After printing, the journal report will still remain in memory and the oldest communication will be erased when a new communication occurs.

When this feature is deactivated, the unit will store the records of the last 35 fax communications, but the unit will not print the journal report automatically.

- 1 Press **MENU**.
Display: SYSTEM SET UP
- 2 Press **#**, then **2** **2**.
AUTO JOURNAL
- 3 Press **START/COPY/SET**.
MODE=ON [▼▲]
- 4 Press ▼ or ▲ to select the desired setting.
- 5 Press **START/COPY/SET**.
- 6 Press **MENU**.

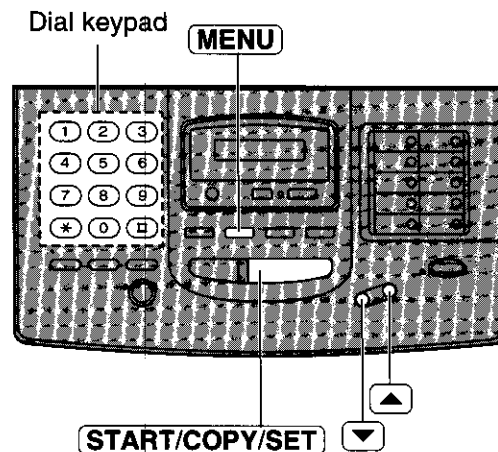

Multi-Function Center

Features

The Multi-Function Center is an application that allows you to use your facsimile unit as a printer, scanner and copier with Windows.

Printer functions

- Printing documents from a Windows application (See page 80.)
- Printing received documents (See page 86.)

Fax functions

- Faxing from a Windows application (See page 82.)
- Faxing a document on the facsimile unit (See page 87.)
- Viewing received faxes on the PC screen (See page 85.)

Scanner functions

- Scanning and saving documents (See page 89.)

Preparation

Connecting to a computer

To run the Multi-Function Center software, you need the following software and hardware.

- IBM PC 386, or higher, or compatible meeting all AT bus specifications (DX 33Mhz minimum recommended).
- Microsoft Windows 3.1, 3.11 or Windows 95 (English version).
- Hard Disk drive with at least fourteen (14) MB of available storage.
- RS232C Serial Port.

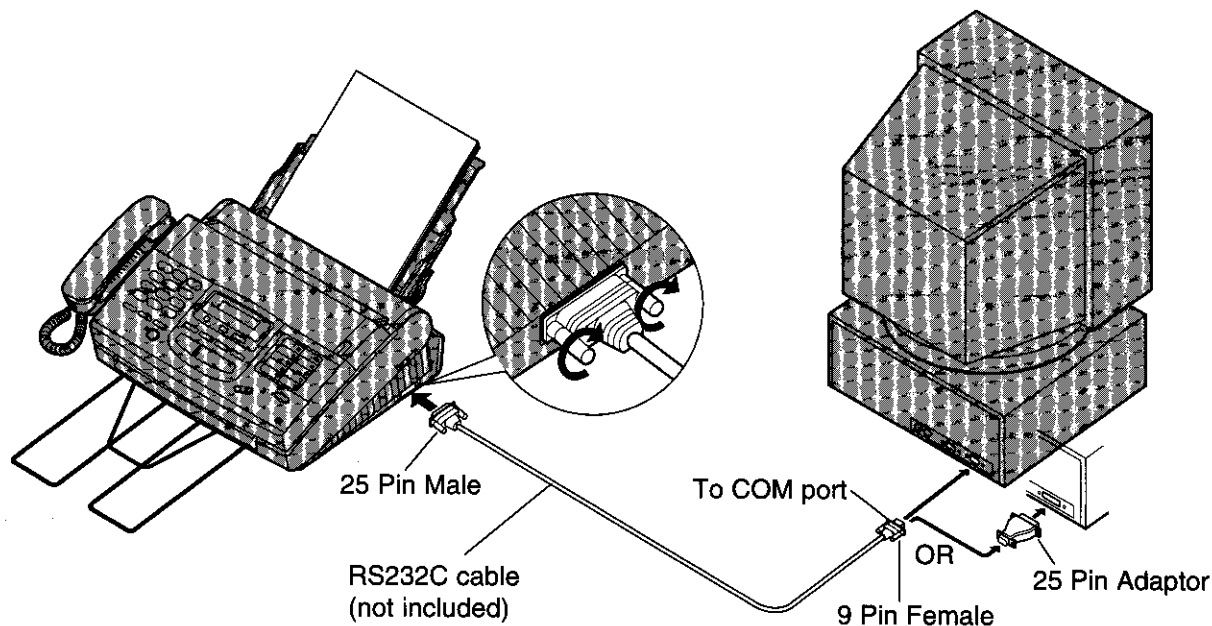

*The RS232C (DB9 Female/DB25 Male) serial cable can also be purchased at a computer supply store.

Communication messages on the report _____

When a problem has occurred, one of the following messages will be printed on the transmission and journal reports:

PRINTED MESSAGE	CODE	MEANING
COMMUNICATION ERROR	41-72 FF	<ul style="list-style-type: none"> •A transmission or reception error occurred. Try again or check with the other party.
DOCUMENT JAMMED	—	<ul style="list-style-type: none"> •A document is jammed. Remove the jammed document (p. 102).
ERROR-NOT YOUR UNIT	—	<ul style="list-style-type: none"> •A transmission or reception error occurred because of the trouble of the other party's machine. Check with the other party.
JUNKMAIL PROH. REJECT	—	<ul style="list-style-type: none"> •The junk mail prohibitor of your unit rejected fax reception.
MEMORY FULL	—	<ul style="list-style-type: none"> •The document was not received due to memory being full.
NO DOCUMENT	—	<ul style="list-style-type: none"> •The document was not fed into the unit properly. Try again.
OTHER FAX NOT RESPOND	—	<ul style="list-style-type: none"> •The receiving unit was busy or ran out of recording paper. Try again. •The START/COPY/SET button was pressed when the document was not set properly. Set the document properly and press the START/COPY/SET button after confirming the fax tone. •The other party's machine is not a facsimile. Check with the other party.
PRESSED THE STOP KEY	—	<ul style="list-style-type: none"> •The STOP button was pressed and fax communication was canceled.
THE COVER WAS OPENED	—	<ul style="list-style-type: none"> •The front cover was opened during fax transmission.
OK	—	<ul style="list-style-type: none"> •Fax communication was successful.

Printing/faxing from a Windows application

Printing documents from a Windows application

You can print documents created from a Windows application. Select **Panasonic MFC Print** as your printer.

For example, to print from Microsoft Word, proceed as follows.

For Windows 95 Users:

- 1 Open the document you wish to print.
- 2 Select **Print** from the **File** menu.
 - The Print dialog box will appear.
- 3 Select **Panasonic MFC Print** from the Name field in the Printer group. <Fig. 1>
- 4 Set the Page range and enter the number of collated copies.
- 5 Select the **Properties** button.
 - The Panasonic MFC Print dialog box will appear. <Fig. 2>
- 6 Set the **Page Size**, **Resolution** and **Orientation**. Then click the **OK** button.
- 7 Click the **OK** button on the Print dialog box.

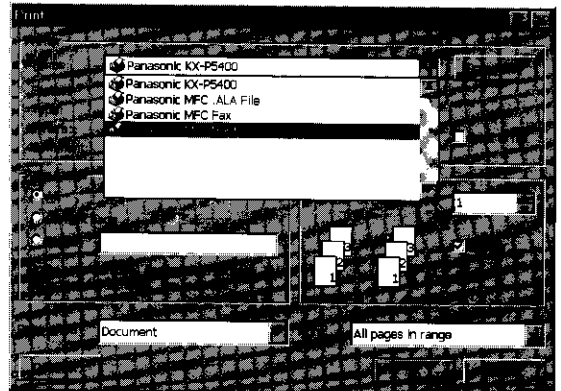

<Fig. 1>

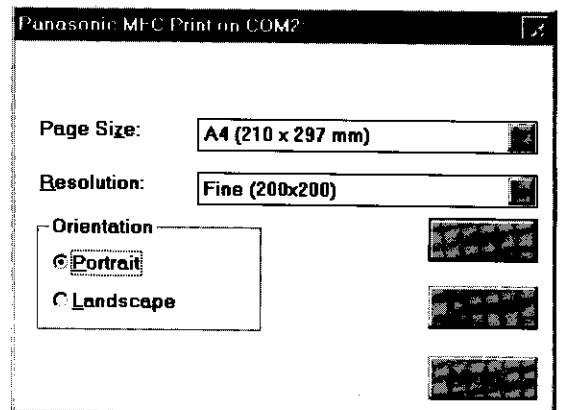

<Fig. 2>

Installing the Multi-Function Center software

- 1 Start Windows 3.1/3.11/95 and close all applications.
- 2 Insert **disk #1** into disk drive A (or B).
- 3 **For Windows 95 users:**
Click **Start** and select **Run...** .
For Windows 3.1 or 3.11 users:
From the Program Manager, click **File** and select **Run...** .
- 4 At the command line, type "a(or b):\setup" and click **OK**.
- 5 Follow the instructions on the screen until all diskettes (**disk #2**, **disk #3**) have been installed.
- 6 Remove the disk from the disk drive and click **Finish** to reboot your PC.

For Windows 95

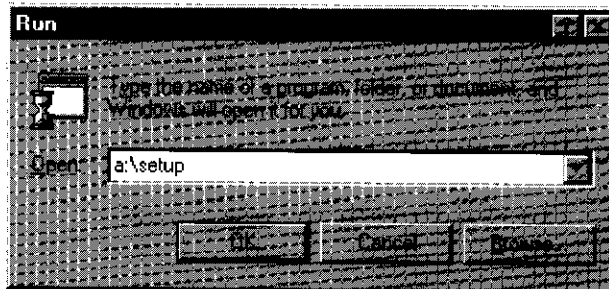

For Windows 3.1

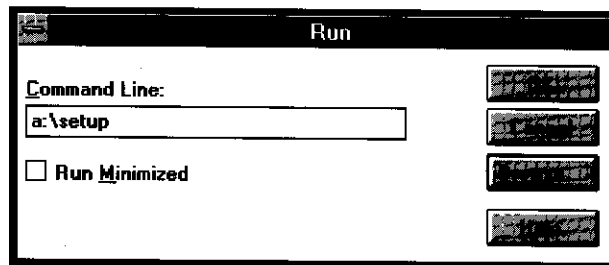

Note:

- If other communication software which uses the serial port has been installed, the communication setting may be changed and the communication software may not function properly when the Multi-Function Center software is installed.
- The dialog box images may differ according to applications.

Included applications

The Multi-Function Center contains the following applications and files.

- **Viewer** Enables you to scan a new image or open an existing image, and then print, fax or edit that image.
- **Copier** Enables you to copy after scanning a document on the facsimile unit, setting the reduction, etc., from your PC.
- **Launch Pad** Enables you to launch any Windows application with a single mouse click.
- **Send From Fax** Enables you to fax a document placed on the facsimile.
- **Address Book** Enables you to list your personal information database for fax and telephone numbers.
- **Finder** Enables you to access your faxes and scanned documents by the File Name and Key phrases.
- **Message Center** Enables you to manage all incoming and outgoing fax messages and print jobs. The Message Center application contains five windows that may remain open or be minimized to one icon within the Message Center main window.
- **ReadMe** Please read this file before using the Multi-Function Center software.

Printing/faxing from a Windows application (cont.)

Faxing from a Windows application

You can access the fax function from a Windows application by using the **Print** command in the **File** menu. Select **Panasonic MFC Fax** as your printer.

To send a document created from Microsoft Word, proceed as follows:

For Windows 95 Users:

- 1 Open the document you wish to send.
- 2 Select **Print** from the **File** menu.
 - The Print dialog box will appear.
- 3 Select **Panasonic MFC Fax** from the Name field in the Printer group and select **Properties**. <Fig. 1>
 - The Panasonic MFC Fax dialog box will appear. <Fig. 2>
- 4 Set the **Page Size**, **Resolution** and **Orientation**. Then click the **OK** button.
- 5 Click the **OK** button on the Print dialog box.
 - The Fax Send dialog box will appear. <Fig. 3>
- 6 Enter the name and fax number using the keyboard or select the desired entry in the address book currently displayed in the Address Book name box.
- 7 Select the **Start** button in the Fax Send dialog box.

Note:

- If the line is busy or there is no answer, the Message Center Outbox application will automatically redial the number up to 2 times.
- To cancel transmission after dialing:**
Press **(STOP)** on the facsimile unit.
OR
Select the **Outbox** window in the **Message Center** window. Then select the **CANCEL** button on the toolbar.

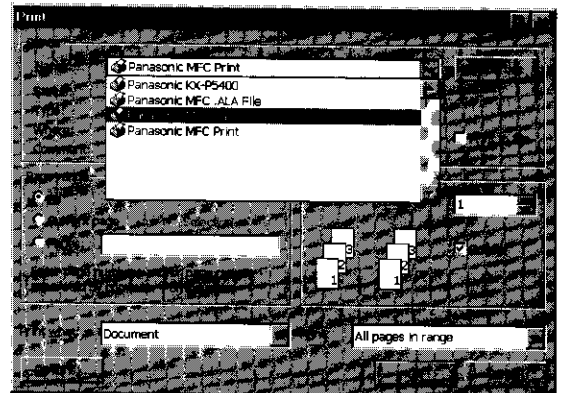

<Fig. 1>

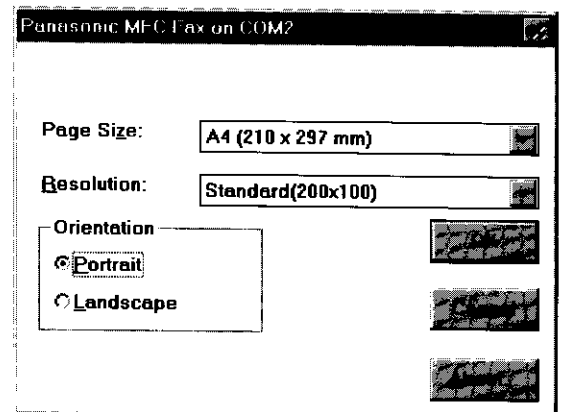

<Fig. 2>

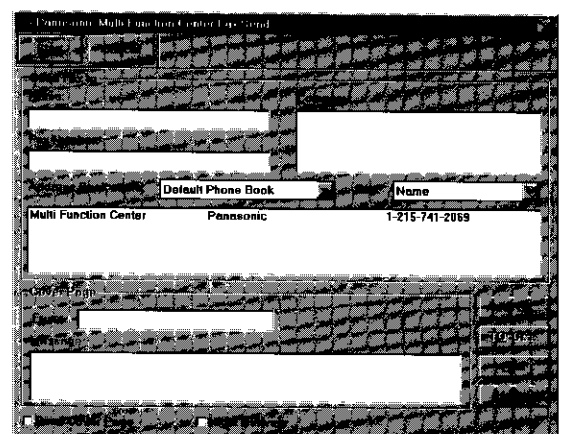

<Fig. 3>

For Windows 3.1/3.11 Users:

- 1** Open the document you wish to print.
- 2** Select **Print** from the **File** menu.
 - The Print dialog box will appear. <Fig. 1>
- 3** Select the **Setup** button.
 - The Print Setup dialog box will appear.
- 4** Select **Panasonic MFC Print** from the **Specific Printer** field. <Fig. 2>
- 5** Select the **Options** button.
 - The Panasonic MFC Print dialog box will appear. <Fig. 3>
- 6** Set the **Page Size**, **Resolution** and **Orientation**. Then click the **OK** button.
- 7** Click the **OK** button on the Print Setup dialog box.
- 8** Click the **OK** button on the Print dialog box.

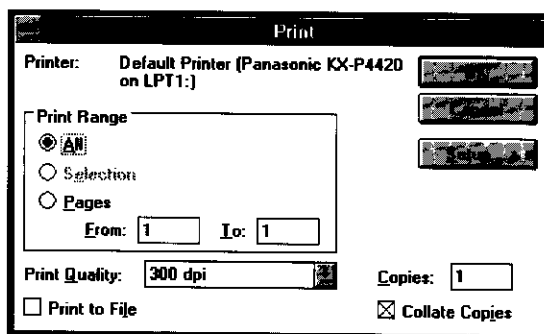

<Fig. 1>

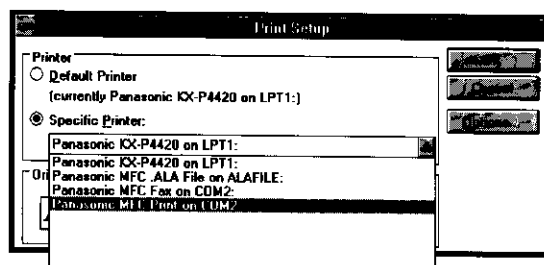

<Fig. 2>

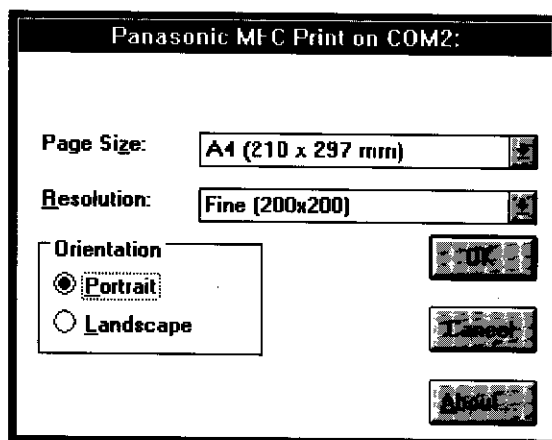

<Fig. 3>

Receiving faxes on your PC

Setup for receiving faxes on your PC

1 If you wish to receive faxes on your PC automatically, turn on AUTO RECEIVE mode on the facsimile unit by pressing **AUTO RECEIVE** or use the MANUAL RECEIVE mode to set to TEL/FAX.

2 Start Windows.

3 Open or minimize the **Message Center** application.
To open the Message Center, follow these steps.

For Windows 95 users:

Select the **Start** button. Point to **Programs**, then **Multi-Function Center**, and then click **Message Center**.

For Windows 3.1/3.11 users:

Double click the **Message Center** icon in the Multi-Function Center program group.

Windows 95

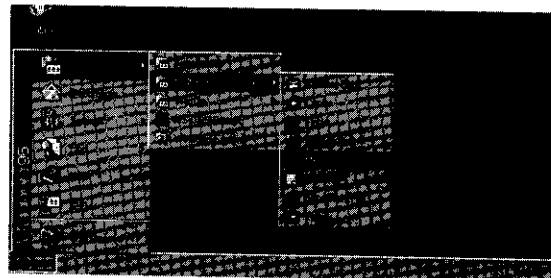

Windows 3.1

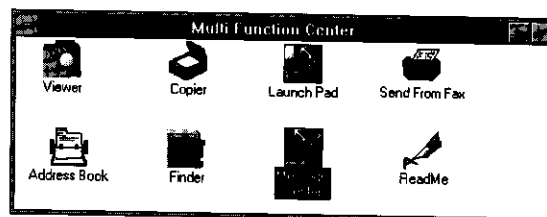

Viewing the list of faxes received

All faxes received by your PC are listed in the **Inbox window** in the **Message Center** application. Inbox allows you to view, print or save faxes and append your faxes to other saved fax documents.

1 **For Windows 95 users:**
Select the **Start** button. Point to **Programs**, then **Multi-Function Center**, and then click **Message Center**.

For Windows 3.1/3.11 users:
Double click the **Message Center** icon in the Windows screen.

2 Select the **Inbox window** from the Message Center window.
•The Inbox window displays the current status of all facsimiles distributed to you in the Inbox queue.

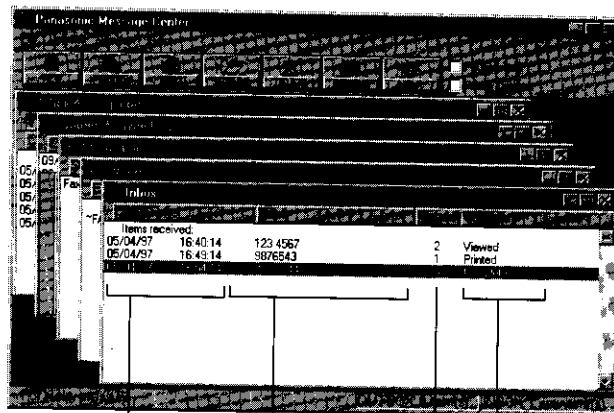

Date and Time Fax ID (if transmitted) Status messages
Number of pages received

Status messages

Complete—The facsimile was received successfully but has not been printed, saved or viewed yet.

Incomplete—An incomplete facsimile was received and has not been printed, saved or viewed yet.

Recovered—The system failed before the facsimile was completely received and was entered in the Inbox. Information in the Log may be incomplete. The facsimile may be incomplete.

Viewed—The facsimile has been viewed but not printed or saved.

Printed—The facsimile was printed but not saved.

Saved—The facsimile has been saved.

Viewing received faxes on the PC screen

To view a fax in your Inbox

- 1 Select the fax you wish to view in the **Inbox** window. <Fig. 1>
- 2 Select **View** from the **File** menu of the Message Center Inbox window or click the **VIEW** button on the toolbar.
 - The Viewer application window will display the selected fax. <Fig. 2>

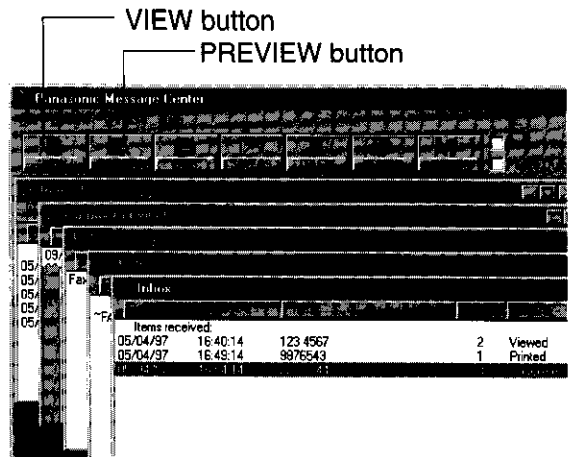

<Fig. 1>

To preview the first page of the received fax

- 1 Select the fax you wish to view in the **Inbox** window. <Fig. 1>
- 2 Select **Preview** from the **File** menu of the Message Center Inbox window or click the **PREVIEW** button on the toolbar.
 - The Preview window will display the first page of the selected fax. <Fig. 3>

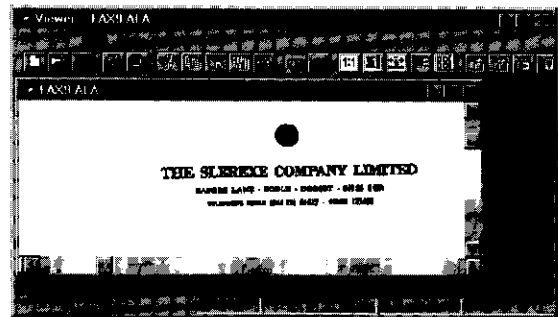

<Fig. 2>

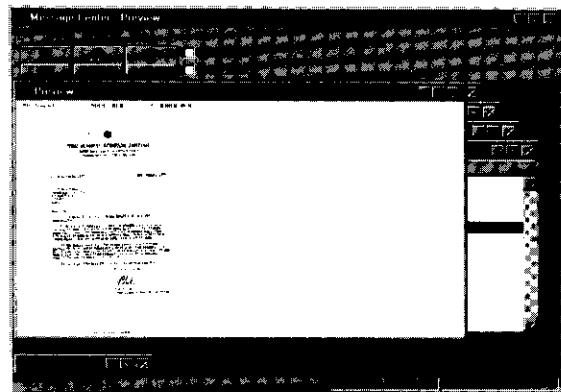

<Fig. 3>

※If you are using Windows 3.1/3.11, the dialog box images shown above will slightly differ from the actual ones.

Receiving faxes on your PC (cont.)

Printing received documents

- 1 Select the document you wish to print in the **Inbox window**.
- 2 Select **Print** from the File menu or the **PRINT** button from the toolbar. <Fig. 1>
 - The Print dialog box will appear. <Fig. 2>
- 3 If you want to change your selected printer or print setup, select **Setup**.
 - The Print Setup dialog box will appear. <Fig. 3>
- 4 If you want to use the facsimile unit as a printer, select **Panasonic MFC print** from the Printer list.
- 5 Choose the printer you wish to use, by selecting the **OK** button.
- 6 Enter the number of copies you want to print in the **Copies** field, and then select the **OK** button.
 - The Inbox Print dialog box will appear. <Fig. 4>
- 7 Select the range of faxes you want to print from the **Inbox Print** group.
 - A. Select **Print Selected** to print the facsimiles you selected.
 - B. Select **Print Unprinted** to print all the unprinted facsimiles.
 - C. Select **Print All** to print all the facsimiles.
- 8 If you want to delete the selected faxes automatically after they have been printed, select the **Delete After Printing** check box.
- 9 If you want the selected fax scaled to fit within the size of paper you selected in the Print Setup dialog box, select **Scale To Fit**.
- 10 Select the **Print** button.

※If you are using Windows 3.1/3.11, the dialog box images shown will slightly differ from the actual ones.

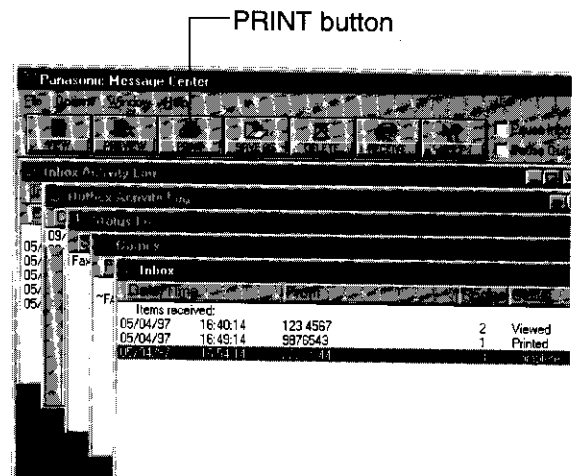

<Fig. 1>

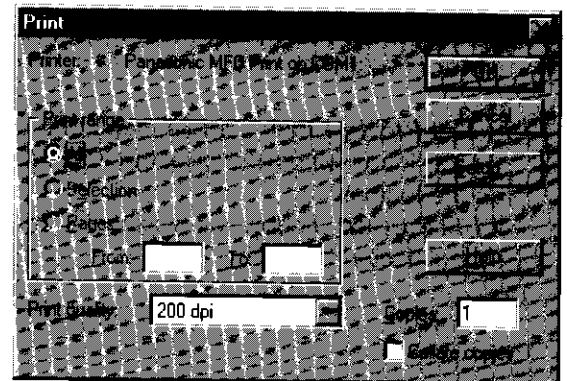

<Fig. 2>

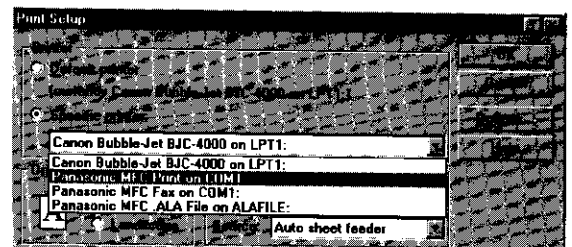

<Fig. 3>

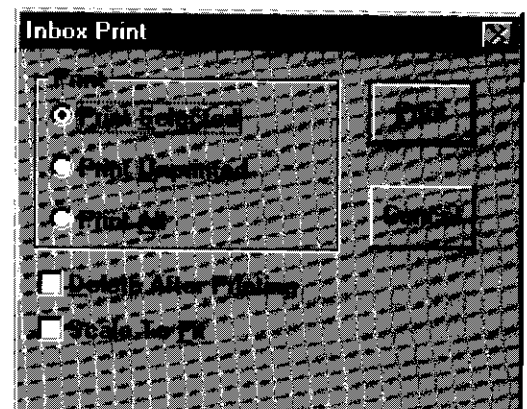

<Fig. 4>

Faxing a document on the facsimile unit

1 Place the document(s) on your fax machine.
<Fig. 1>

2 **For Windows 95 Users:**
Select the **Start** button. Point to **Programs**, point to **Multi-Function Center**, then click **Send From Fax**.

For Windows 3.1/3.11 Users:
Double click **Send From Fax** in the Multi-Function Center program group.

•The Send From Fax application window will appear. <Fig. 2>

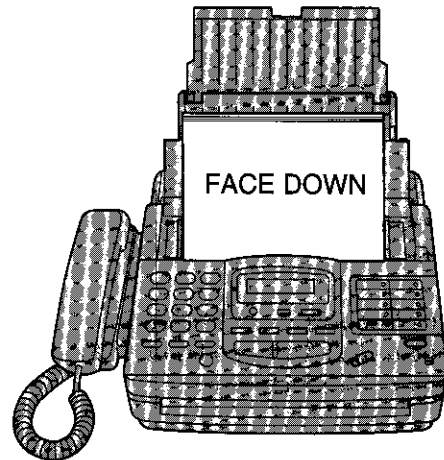

<Fig. 1>

3 Enter the name and fax number using the keyboard or select the desired entry in the address book currently displayed in the Address Book name box.

4 You can access the Address Book application by selecting **Addr Bk...** or the Address Book menu.
•The Address Book application window will appear.

5 If you accessed the Address Book application, select **Exit** from the File menu.

6 Select the **Start** button in the Send From Fax application window.

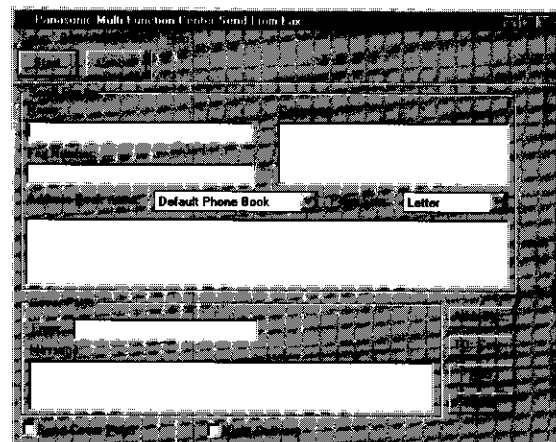

<Fig. 2>

※If you are using Windows 3.1/3.11, the dialog box image shown above will slightly differ from the actual one.

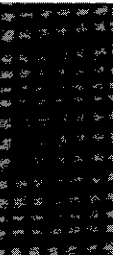

Making an Address Book

The Address Book is your personal information database for fax and telephone numbers.

To make the Address Book:

1 For Windows 95 Users:
Select the **Start** button. Point to **Programs**, point to **Multi-Function Center**, then click **Address Book**.

For Windows 3.1/3.11 Users:
Double click **Address Book** in the Multi-Function Center program group.

•An Address Book will be displayed. <Fig. 1>

2 Click the **File** menu and select **New**.
•A New dialog box will be displayed. <Fig. 2>

3 Enter the File Name. Enter the Address Book name. Click the **OK** button.
•The Address Book is made.

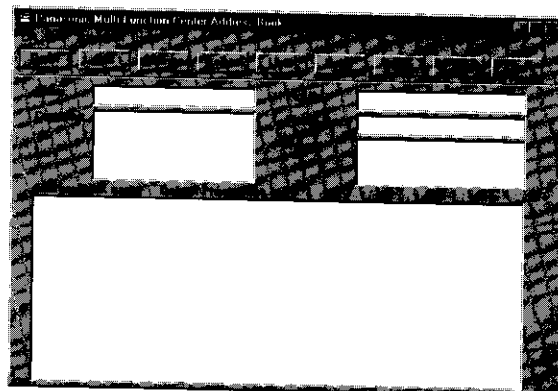

<Fig. 1>

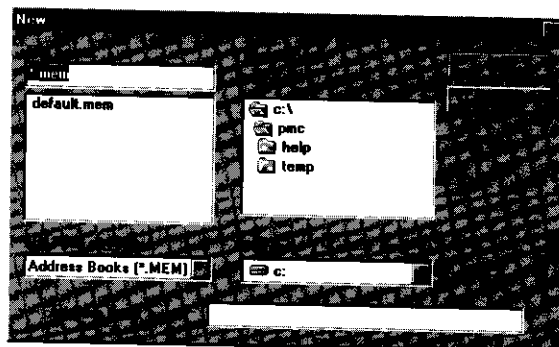

<Fig. 2>

To make an entry in the Address Book:

1 Click the **Open** button.
•The open dialog box will be displayed. <Fig. 3>

2 Select the desired Address Book and click the **OK** button.

3 Enter or edit the Name, Company, Fax No., Telephone No. and Notes.

4 Click the **Add** button. <Fig. 4>
•The entry will be added to the Address Book.

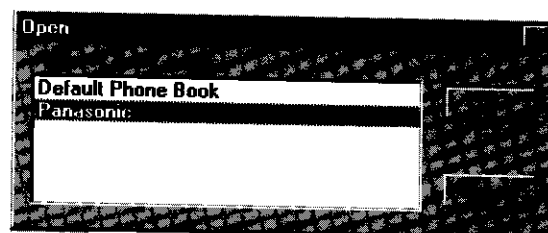

<Fig. 3>

Broadcast

When sending the same document to more than one location, you can use the list function in the Address Book. You may select as many locations as you want from the Address Book.

※If you are using Windows 3.1/3.11, the dialog box images shown will slightly differ from the actual ones.

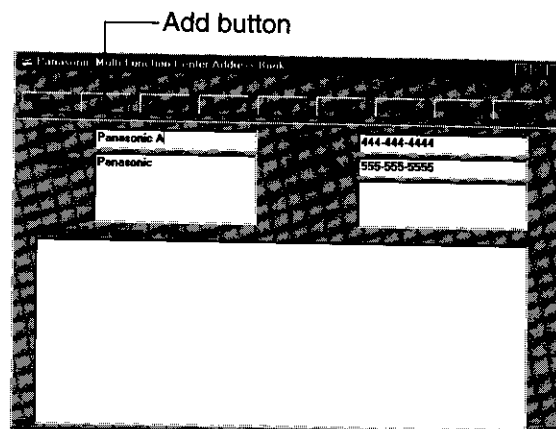

<Fig. 4>

Scanning and saving documents

Your facsimile unit can be used as a scanner to enable you to incorporate image files into other Windows applications. The scanned file can be saved as an .ALA (image) file, a .TIF, .PCX, .DCX, or .BMP file.

- 1 Place the document(s) on your fax machine.
<Fig. 1>
- 2 **For Windows 95 Users:**
Select the **Start** button. Point to **Programs**, point to **Multi-Function Center**, and then click **Viewer**.
 - The Viewer application window will appear.**For Windows 3.1/3.11 Users:**
Double click **Viewer** in the **Multi-Function Center**.
 - The Viewer application window will appear.
- 3 Select **Scan** from the **File** menu. <Fig. 2>
 - The TWAIN Scanner dialog box will appear. <Fig 3>
- 4 Set the intensity and optimize for the type of document you are scanning.
- 5 Select **Scan**.
 - The scanned document is displayed in the Viewer application window.
- 6 Select **Save As...** from the **File** menu.
 - The Save As dialog box will appear. <Fig. 4>
- 7 Enter the file name in the **File name** text box, and then select the drive and directory where you want to store the document.
- 8 Select the **OK** button.

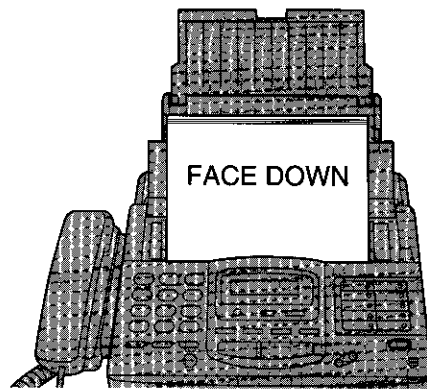

<Fig. 1>



<Fig. 2>

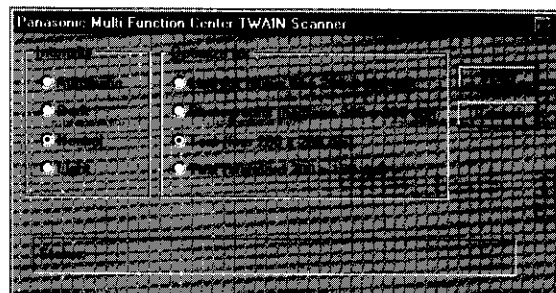

<Fig. 3>

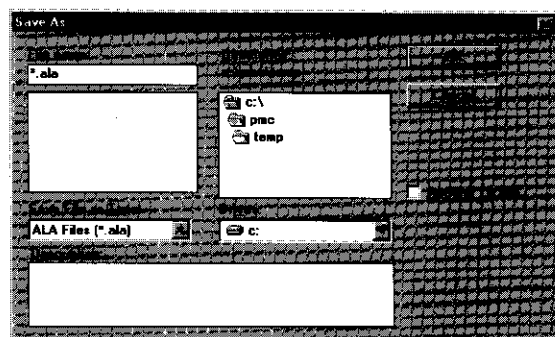

<Fig. 4>

※If you are using Windows 3.1/3.11, the dialog box images shown will slightly differ from the actual ones.

Receiving faxes directly to your fax machine =====

If you do not want to be disturbed by incoming faxes when using the PC, but want to receive faxes directly to your facsimile machine, set one of the following.

- Pause your Inbox on the PC
- Turn off the PC LINK on the facsimile unit

To pause your Inbox

From the Inbox window select **Pause Inbox** from the **File** menu or select the **Pause Inbox** check box on the Toolbar.

To turn off the PC LINK on the facsimile unit

- When this feature is off, any operation from your PC like fax transmission/reception, scanning, printing or copying cannot be performed.

1 Press **MENU**.

Display: SYSTEM SET UP

2 Press **#**, then **1** **4**.

PC LINK

3 Press **START/COPY/SET**.

MODE=ON [▼▲]

4 Press ▼ or ▲ to select "OFF".

- To turn on the PC LINK on the facsimile unit, select "ON".

5 Press **START/COPY/SET**.

6 Press **MENU**.

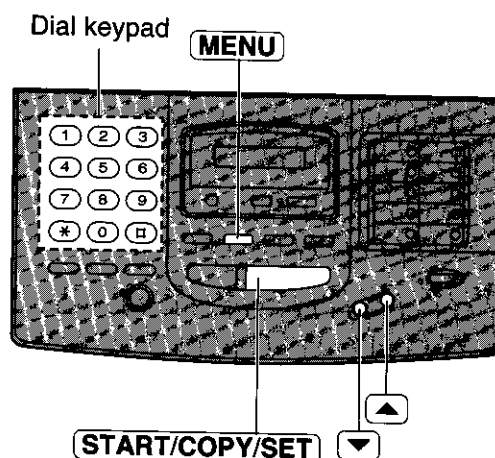

Getting help for further information ---

To obtain information about the Multi-Function Center applications, use the help function.
For help, follow these steps.

For Windows 95 Users:

1. Click the **Start** button.
2. Click **Programs**.
3. Click **Multi-Function Center**.
4. Click the application you need help with.
5. Click **Help** menu.
6. Click **Index** or **Contents** and choose the subject you need help with.

For Windows 3.1/3.11 Users:

1. In Program manager, double click **Multi-Function Center**.
2. Double click the application you need help with.
3. Click **Help** menu.
4. Click **Index** or **Contents** and choose the subject you need help with.

Functions of the Multi-Function Center applications ---

Applications	Functions
Viewer	<i>Editing images</i> <ul style="list-style-type: none">● Clearing portions of an image● Copying to the Windows Clipboard● Cropping images● Cutting images● Cutting or copying an entire image● Inverting the color of an image● Pasting from the Windows Clipboard● Stretching and shrinking images● Symmetrically changing the size of an image <i>Viewing Images</i> <ul style="list-style-type: none">● Adding an application button to the Action Bar● Arranging how windows and icons are displayed● Displaying thumbnails● Hiding or displaying the Toolbar, Status Bar or Action Bar● Magnification, reductions or orientations● Next or previous page● Rotating the image● Viewing different pages of a multiple page file● Zooming—Sizing the image to the size of the window● Zooming in a specified area of the image
Copier	<ul style="list-style-type: none">● Making a Copy● Making multiple copies● Reducing/enlarging your copy● Setting up your Copier● Choosing a printer
Address Book	<ul style="list-style-type: none">● Changing address books● Copying Information into the clipboard● Dialing a voice number● Pasting information into your address book● Printing an address book entry or the entire book● Saving the address book as a file● Sending a cover page fax● Using editing key combinations to Cut, Paste, Copy and Undo editing



Getting help for further information (cont.)

Applications	Functions
Message Center	<ul style="list-style-type: none">● Cover page—Creating and Setting up● Setting Up Your Personal Information—PC Fax Logo, Telephone Number, and Night Delivery Time● Time/Date stamp on received faxes● Resending a fax● Automatically printing incoming faxes● Loading the Message Center automatically <p><i>Received Faxes</i></p> <ul style="list-style-type: none">● Inbox Activity Log● Automatically deleting your faxes after printing● Deleting faxes● Stop receiving faxes on the PC● Manually receiving faxes● Monitoring the fax line status● Pausing and Resuming the Inbox so that you can run other communications programs● Previewing a received fax listed in the Inbox window● Printing faxes● Saving faxes● Viewing the list of received faxes● Stamping received facsimiles with the time/date received● Viewing faxes <p><i>Sending Faxes</i></p> <ul style="list-style-type: none">● Viewing the list of outgoing faxes● Resending undelivered facsimiles● Changing the destination fax number or delivery schedule● Unsuccessful dialing attempts <p><i>Canceling Faxes</i></p> <ul style="list-style-type: none">● Pause and Resume sending facsimiles● Deleting facsimiles● Monitoring the Fax line status● Viewing the Outbox queue● Outbox Activity Log
Send From Fax	<ul style="list-style-type: none">● Adding the current addressee to an Address Book● Changing Address Books● Choosing the Resolution● Phone Number (addressing your fax)● Sending a fax to multiple recipients (Specify To: Cc: Faxes)● Sending a fax while you are doing other work on your PC● Sending a fax with a cover page● Sending a fax without a cover page● Setting up your scanner● Sorting the Address Book● Specifying a distribution list as your fax destination
Finder	<ul style="list-style-type: none">● Deleting files● Printing, viewing and faxing files● Searching for files
Launch Pad	<ul style="list-style-type: none">● Adding an application to your Launch Pad icon bar● Automatically activating the Launch Pad● Making your Launch Pad icon bar always visible on your desktop● Removing an application from the Launch Pad

Troubleshooting

Error messages on the display

If the unit detects a problem, one or more of the following messages will appear on the display:

DISPLAY MESSAGE	CAUSE & REMEDY
CALL SERVICE	•There is something wrong with the unit. Contact our service personnel.
CHECK COVER	•The front cover is open. Close it.
CHECK DOCUMENT	•The document is not fed into the unit properly. Reinsert the document. If misfeeding occurs frequently, clean the document feeder rollers inside the unit (p. 105). If the problem remains, adjust the feeder pressure (p. 102).
CHECK FILM	•The film cartridge is not inserted properly. Reinsert it correctly (p. 103, 104).
CHECK LEVER	•The recording paper set lever is released. Push it back to set the lever (p. 9).
CHECK MEMORY	•Memory (telephone numbers, parameters, etc.) has been erased. Re-program.
CHECK PAPER	•The recording paper is not installed or the unit ran out of paper. Install paper (p. 8). •The recording paper is not fed into the unit properly or has jammed near the recording paper entrance. Clear the jammed paper (see "When paper has jammed near the recording paper entrance" on page 101). Do not install folded or heavily curled paper in the paper tray.
FAX IN MEMORY	•The unit has (a) document(s) in memory. See the other message instructions to print out the document(s).
FAX MEMORY FULL	•The memory is full of received documents due to a lack of recording paper or a recording paper jam. Install paper or clear the paper jam.
FILM EMPTY	•The film is empty. Replace the film or film cartridge with a new one (p. 103, 104). •The film is slack. Tighten it (see step 8 on page 104) and install again.
FILM NEAR EMPTY	•The remaining film can print approx. 10 pages of A4 size documents. Prepare a new film or film cartridge (p. 6).
MESSAGE FULL	•There is no room left in memory to record a voice message. Erase some or all of the messages (p. 26, 54).
NO RESPONSE	•The receiving unit is busy or ran out of recording paper. Try again.
PAPER JAMMED	•A recording paper jam occurred under the film cartridge. Clear the jammed paper (p. 100).

(continued)

Error messages on the display (cont.)

DISPLAY MESSAGE	CAUSE & REMEDY
PC FAIL OR BUSY	<ul style="list-style-type: none"> ●The fax function cannot be operated on the PC. The RS232C cable is not connected correctly, or the software is not running on the PC.
PLEASE WAIT	<ul style="list-style-type: none"> ●The unit is checking if the film is set correctly. Wait for a while.
POLLING ERROR	<ul style="list-style-type: none"> ●The other fax machine does not have a polling feature. Check with the other party.
REDIAL TIME OUT	<ul style="list-style-type: none"> ●The receiving unit is busy or ran out of recording paper. Try again.
REMOVE DOCUMENT	<ul style="list-style-type: none"> ●The document is jammed. Remove the jammed document (p. 102). ●Attempted to transmit a document longer than 600 mm (23$\frac{5}{8}$"'). Press the STOP button and remove the document (p. 102). Divide the document into two or more sheets and try again.
REMOVE PRINTOUT	<ul style="list-style-type: none"> ●There is too much paper on the paper stacker. Remove the printed paper. If the display message still remains after removing the paper, a paper jam may have occurred. Remove the jammed paper (see "When paper has jammed near the recording paper exit" on page 101).
STARTER FILM END	<ul style="list-style-type: none"> ●The starter film is empty. Replace the film or film cartridge with a new one (p. 103, 104).
TRANSMIT ERROR	<ul style="list-style-type: none"> ●A transmission error occurred. Try again.
UNIT OVERHEATED	<ul style="list-style-type: none"> ●The unit is too hot. Let it cool down.

Before requesting help

General

PROBLEM	CAUSE & REMEDY
I cannot make and receive calls.	<ul style="list-style-type: none"> •The power cord or telephone line cord is not connected. Check the connections (see page 10).
The unit does not work.	<ul style="list-style-type: none"> •Disconnect the unit from the telephone line and connect a known working telephone. If the known working telephone operates properly, call your service center to have the unit repaired. If the known working telephone does not operate properly, consult with your telephone company.
The unit does not ring.	<ul style="list-style-type: none"> •The ringer volume is set to OFF. Adjust to a suitable level (see page 17).
The REDIAL/PAUSE button does not function properly.	<ul style="list-style-type: none"> •If this button is pressed during dialing, a pause will be inserted. If pressed immediately after a dial tone is obtained, the last number dialed will be redialed.
The receive mode does not function as explained on page 22.	<ul style="list-style-type: none"> •The ring pattern detection is set. Check it (see page 46).
During programming, I cannot enter the remote fax activation code or the remote operation ID.	<ul style="list-style-type: none"> •All or part of the number is the same as another code or ID. Change the number (see pages 44 and 52).

Fax transmission

PROBLEM	CAUSE & REMEDY
The other party complains that letters on their received document are distorted.	<ul style="list-style-type: none"> •If your line has special telephone services such as call waiting, the service may have been activated during fax transmission. Connect the unit to a line that does not have such services. Or suspend Call Waiting. •An extension telephone on the same line is off the hook. Hang up and try again.
The other party complains that dirty patterns or black lines appear on their received documents.	<ul style="list-style-type: none"> •The glass or rollers are dirty. Clean them (see page 105).
The other party complains that they cannot send documents.	<ul style="list-style-type: none"> •The junk mail prohibitor is set to ON. Program their facsimile number for automatic dialing (see page 33) or set the junk mail prohibitor to OFF (see page 45).
I cannot make an international fax call.	<ul style="list-style-type: none"> •Use the overseas transmission mode (see page 64). •Add two pauses at the end of the telephone number (see page 37).

Before requesting help (cont.)

Fax reception

PROBLEM	CAUSE & REMEDY
I cannot receive documents automatically.	<ul style="list-style-type: none"> •The receive mode is set to the TEL mode. Set to the ANS/FAX, TEL/FAX or FAX mode. •The time to answer the call may be too long. Decrease the number of rings (see pages 59, 60 and 61). •The greeting message is too long. Shorten the message (see page 47). •The junk mail prohibitor is set to ON. (see page 45). •FaxAbility is set on but you do not have the service (see page 46).
The recording image is faint.	<ul style="list-style-type: none"> •The sender transmitted a faint document. Ask them to transmit a clearer copy of the document. •The thermal head is dirty. Clean it (see page 105).
The printing quality is poor.	<ul style="list-style-type: none"> •Some paper has instructions recommending the side to print on. Try turning the paper over.
A blank sheet is ejected after the received documents are printed out.	<ul style="list-style-type: none"> •The receiving reduction rate is not programmed correctly. Program the proper reduction rate (see page 66).

Answering device

PROBLEM	CAUSE & REMEDY
No voice messages have been recorded in the ANS/FAX mode.	<ul style="list-style-type: none"> •The memory is full. Erase some or all of the messages (see pages 26 and 54).
I cannot retrieve recorded messages from a remote telephone.	<ul style="list-style-type: none"> •Make sure that you use the remote operation ID correctly (see page 52).

Copying

PROBLEM	CAUSE & REMEDY
A dirty pattern or a black line appears on the copied documents.	<ul style="list-style-type: none"> •The glass or rollers are dirty. Clean them (see page 105).
The copied image is distorted.	<ul style="list-style-type: none"> •The thermal head is dirty. Clean it (see page 105).
The document is not copied properly.	<ul style="list-style-type: none"> •The film is not inserted correctly. Insert it correctly (see pages 103 and 104).
The copied document is blank.	<ul style="list-style-type: none"> •The film is not inserted correctly. Insert it correctly (see pages 103 and 104).
The printing quality is poor.	<ul style="list-style-type: none"> •Some paper has instructions recommending the side to print on. Try turning the paper over.
A paper jam occurs during copying.	<ul style="list-style-type: none"> •The film is not inserted correctly. Insert it correctly (see pages 103 and 104).

If a power failure occurs...

When a power failure occurs, note the following:

- The unit will not function during a power failure.
- Transmission and reception will be interrupted. Check the transaction by printing a journal report.
- If fax documents are stored in memory, they will be lost. When power is restored, a power down report will be printed out stating which contents in memory have been erased.
- If delayed transmission is set and the programmed start time has passed during a power failure, transmission will be attempted soon after power is restored.

Power down report

The power down report will be automatically printed out after power is restored.
The report will not be printed out when there are no documents stored in memory.

Power down report sample

<u>POWER DOWN REPORT</u>				
POWER DOWN AT:Jan. 05 1997 04:30AM				
RESTARTED AT:Jan. 05 1997 04:31AM				
<< WARNING >>				
CONTENTS HAVE BEEN CLEARED DUE TO POWER DOWN.				
FOR ADDITIONAL INFORMATION, PLEASE SEE THE JOURNAL REPORT.				
NO.	OTHER FACSIMILE	MODE	PAGES	FUNCTION
01	<FAX # NOT AVAIL.>	RX	01	MEMORY RECEIVE

Error codes on your PC when using Multi-Function Center software

When using the Multi-Function Center software and the printer or scanner function is initiated and an error occurs, an 8 digit error code will be displayed on the status log window. See the printer 8 digit error code below and the scanner 8 digit code on page 99.

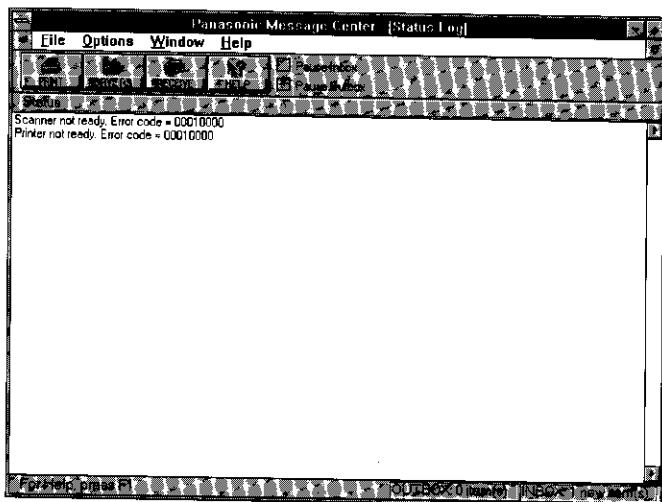

■ Error code for "Printer not ready." status:

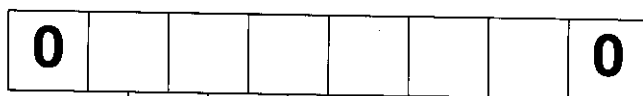

Recording paper set lever:

When this digit is "1", the recording paper set lever is released. Push it back to set the lever (p. 9).

Paper jam near the recording paper entrance:

When this digit is "1", the recording paper is not fed into the unit properly or has jammed near the recording paper entrance. To clear, see page 101.

Paper jam under the film cartridge or too much paper on the paper stacker:

When this digit is "1", the recording paper jammed under the film cartridge or there is too much paper on the paper stacker. Clear the jammed paper (p. 100) or remove the printed paper.

Cover open:

When this digit is "1", the top cover is open. Close it.

Film:

When this digit is "1", film is empty or the film is not inserted in the cartridge correctly. Replace the film or film cartridge with a new one (p. 103) or reinsert the film correctly by referring to step 8 on page 104.

Unit overheat:

When this digit is "1", the unit is overheated. Leave it to cool down.



■ Error code for “Scanner not ready.” status:

0	0	0				0	0
---	---	---	--	--	--	---	---

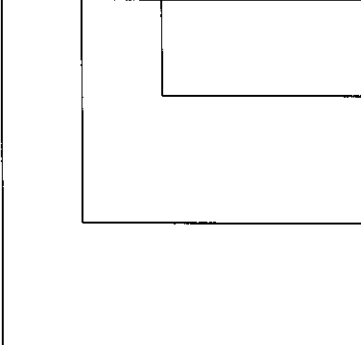

Document feed:

When this digit is “1”, the document is not fed into the unit properly. Reinsert the document.

Document jam:

When this digit is “1”, the document is jammed. Remove the jammed document (p. 102).

Cover open:

When this digit is “1”, the top cover is open. Close it.

For example:

If “1” appears in the 8 digit code, see the corresponding instructions and solve the problem.

e.g. When “Scanner not ready. Error code=00010000” is displayed on the Status Log window:

Cause & remedy—The top cover is open. Close it.



Clearing a recording paper jam

If the unit does not eject any recording paper during reception or copying, the recording paper has jammed. Remove the jammed paper by following the display message on this page and page 101.

When paper has jammed under the film cartridge

The display will show the following message:

PAPER JAMMED

Remove the jammed paper as follows:

- 1 Slide the front cover open lever forward to unlock the front cover and lift open.

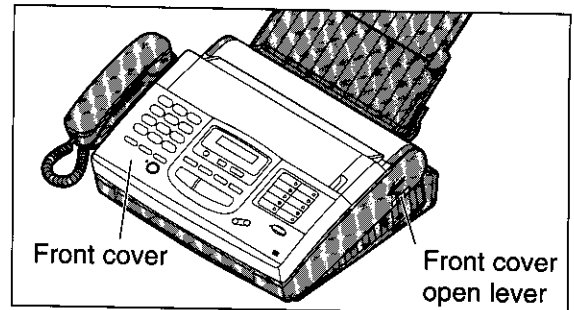

- 2 Remove the film cartridge.

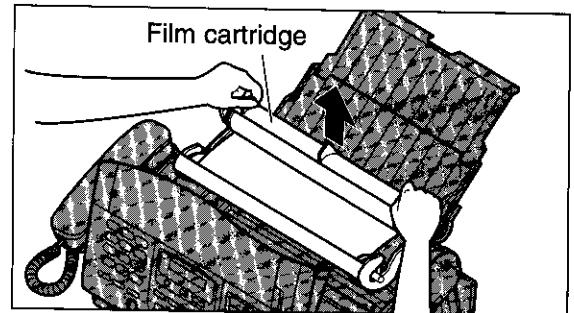

- 3 Remove the jammed recording paper.

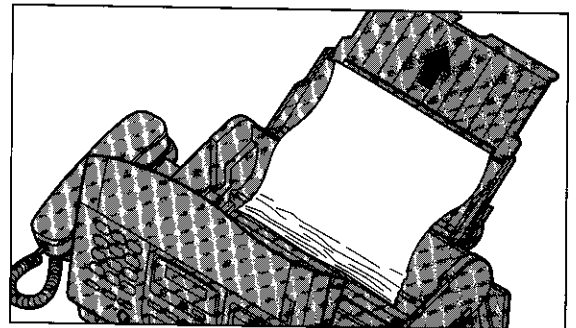

- 4 If the film is slack, tighten it by winding the bottom side gears.

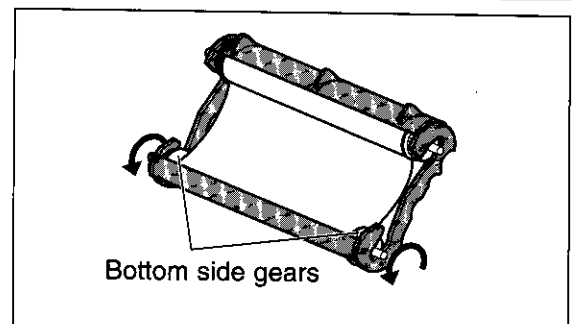
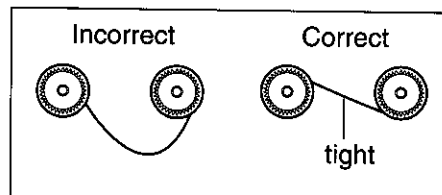

- 5** Replace the film cartridge by matching the blue label side of the cartridge with that on the unit.
- 6** Close the front cover securely by pushing down on both ends.

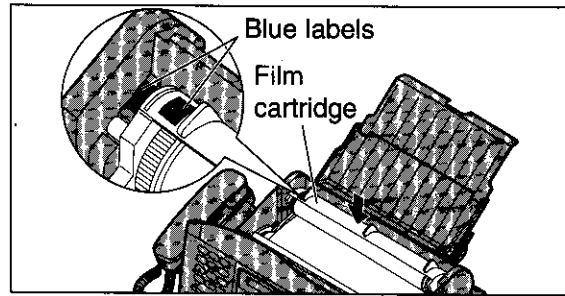

When paper has jammed near the recording paper entrance

The display will show the following message:

CHECK PAPER

Remove the jammed paper as follows:

Pull the recording paper set lever forwards, then pull out the jammed recording paper from the recording paper entrance.

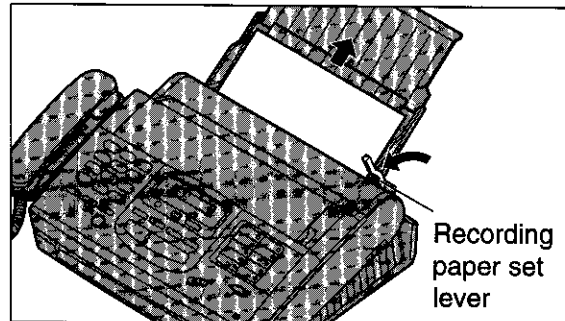

When paper has jammed near the recording paper exit

The display will show the following message:

REMOVE PRINTOUT

Remove the jammed paper as follows:

- 1** Lift the unit slightly and push out the jammed recording paper from the triangular window on the bottom of the unit.
- 2** Remove the jammed recording paper from the recording paper exit.

- If you cannot remove the jammed paper, remove it by following steps 1–4 on page 100.

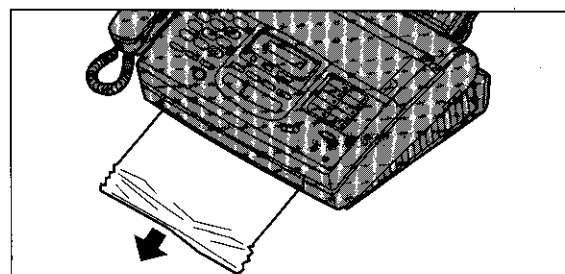
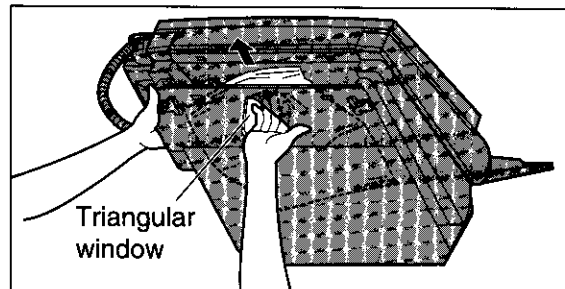

Clearing a document jam

If the unit does not release the original document during feeding, remove the document as follows:

- 1** Slide the front cover open lever forward to unlock the front cover and lift open.
- 2** Remove the jammed document carefully.
- 3** Close the front cover securely by pushing down on both ends.

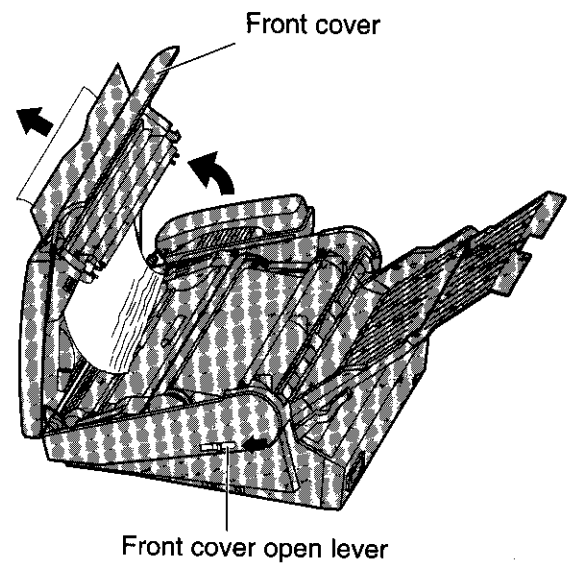

Adjusting the feeder pressure

When no feeding or multiple feeding occurs frequently, adjust the feeder pressure.

- 1** Slide the front cover open lever forward to unlock the front cover and lift open.
- 2** Shift the position of the lever by using an instrument with a pointed end, like a clip or ball-point pen.

Position A: When documents do not feed
Position B: Standard position (pre-selected)
Position C: When documents multiple feed

- 3** Close the front cover securely by pushing down on both ends.

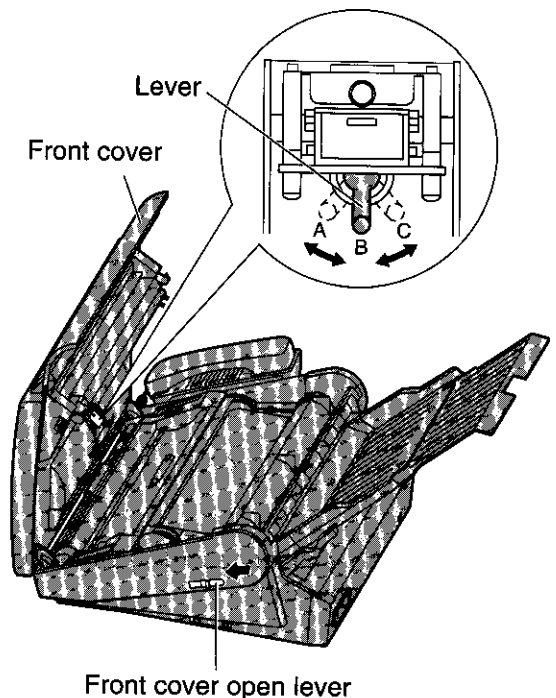

Routine care

Checking the remaining film

Press **FILM REMAINING** while the unit is idle. The display indicates the approximate amount of remaining film.

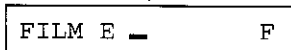
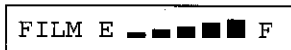

When the film indicator points to this position, the remaining film will print up to 20 pages of A4 size documents. Prepare a new film or film cartridge for replacement.

Replacing the film or film cartridge

When the unit detects the end of the film, one of the following messages will be displayed:

FILM NEAR EMPTY

The remaining film prints approx. 10 pages of A4 size documents. Prepare a new film or film cartridge.

FILM EMPTY

The film is empty. Replace the film or film cartridge with a new one.

To order replacement parts, see page 6.

1 Slide the front cover open lever forward to unlock the front cover and lift open.

2 Remove the film cartridge.

- If you have purchased a film cartridge (Model no. KX-FA135A) for replacement, skip to step 9.
- To replace only the film, go to step 3.

3 Unlock the four gears by (A) pulling the top side gears (blue and green) forward and (B) pushing back the bottom side gears (green). Remove the used film.

4 Remove the four gears from the used film cores.

Caution:

- The film is not reusable. You can order a new film for replacement through your nearest authorized Panasonic dealer.

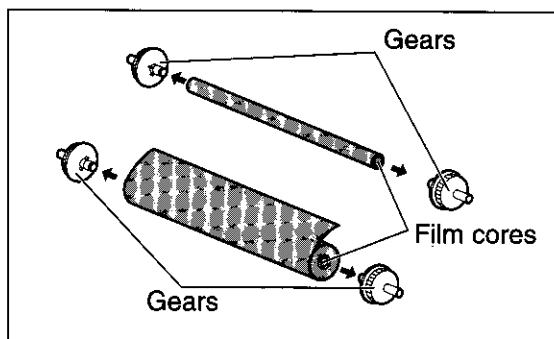
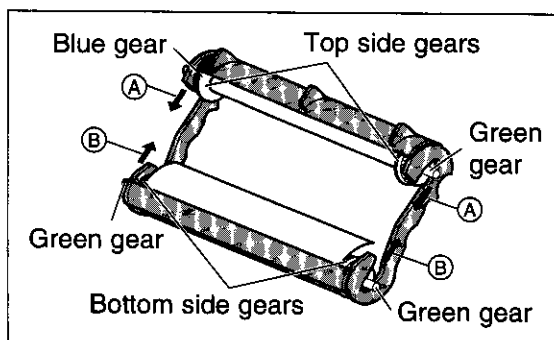
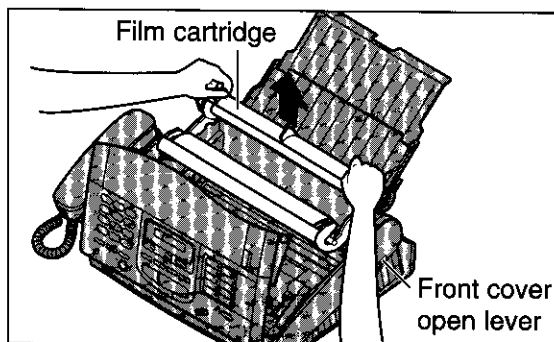

(continued)

Replacing the film or film cartridge (cont.)

- 5** Insert the blue gear into the blue core of the new film.

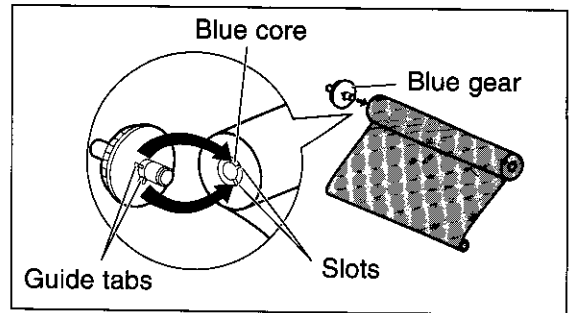

- 6** Insert the three green gears into the remaining cores of the new film.

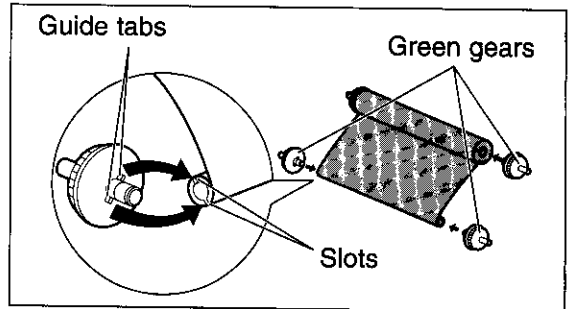

- 7** Insert the film into the cartridge so that the blue gear matches the blue label on the cartridge.

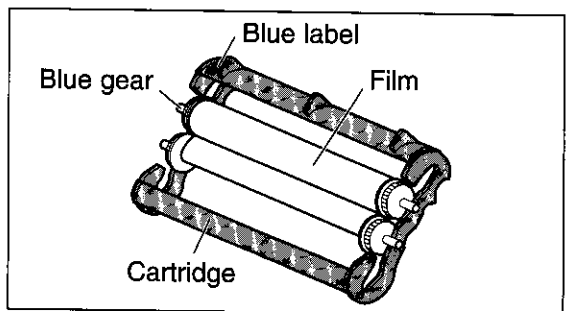

- 8** Lock the four gears of the film by (A) pushing back the top side gears and (B) pulling the bottom side gears forward until they lock into place.
- If the film is slack, tighten it by winding the bottom side gears.

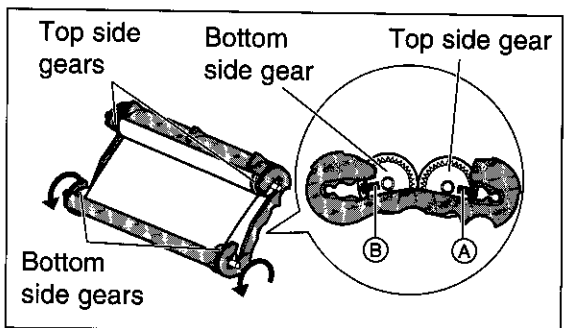
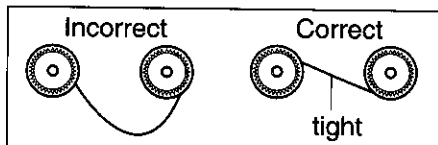

- 9** Insert the film cartridge by matching the blue label on the cartridge with that on the unit.

- 10** Close the front cover securely by pushing down on both ends.

- The unit will check that the film is set correctly and the following message will be displayed:

Display: PLEASE WAIT

- If the following message is displayed, the film is not inserted correctly:

CHECK FILM

Reinsert it correctly.

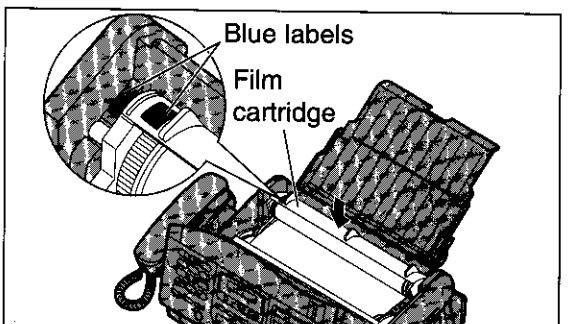

Cleaning the inside of the unit

Cleaning the document feeder unit

If misfeeding occurs frequently or dirty patterns or black bands appear on a copied or transmitted document, clean the document feeder rollers, sub roller, rubber flap, white plate and glass.

- 1 Disconnect the power cord and the telephone line cord.
- 2 Slide the front cover open lever forward to unlock the front cover and lift open.
- 3 Clean the document feeder rollers, sub roller and rubber flap with a cloth moistened with isopropyl rubbing alcohol, and let dry thoroughly.
- 4 Clean the white plate and glass with a soft dry cloth.
- 5 Close the front cover by gently pressing down on both ends.
- 6 Connect the power cord and the telephone line cord.

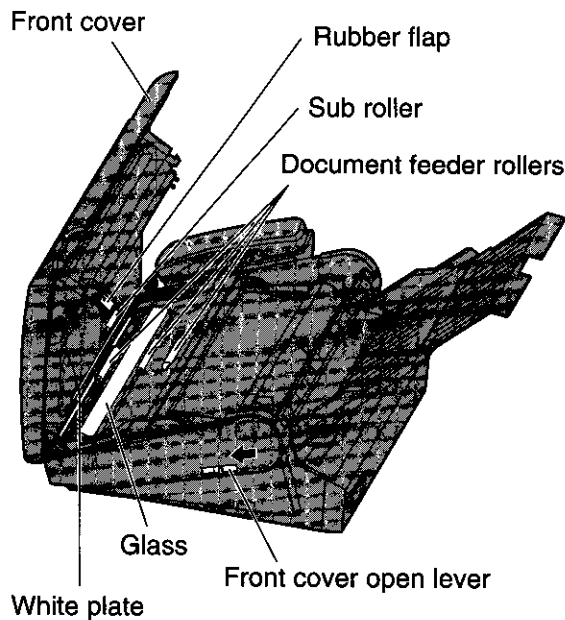

Caution:

- Do not use paper products (such as paper towels or tissues) to clean the inside of the unit.

Cleaning the thermal head

If dirty patterns or black bands appear on a copied or received document, clean the thermal head.

- 1 Disconnect the power cord and the telephone line cord.
- 2 Slide the front cover open lever forward to unlock the front cover and lift open.
- 3 Clean the thermal head with a cloth moistened with isopropyl rubbing alcohol, and let dry thoroughly.
- 4 Close the front cover by gently pressing down on both ends.
- 5 Connect the power cord and the telephone line cord.

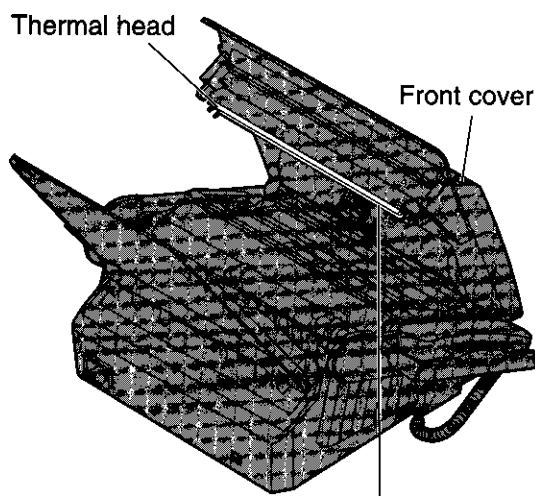

Caution:

- To prevent a malfunction due to static electricity, do not use a dry cloth and do not touch the thermal head directly with your finger.

Caution

Do not push on the black cover.

General Information

Specifications

1. **Applicable Lines:** Public Switched Telephone Network
2. **Document Size:** Max. 216 mm (8½") in width
Max. 600 mm (23⅝") in length
3. **Effective Scanning Width:** 208 mm (8⅜")
4. **Recording Paper Size:** A4: 210 × 297 mm (8¼" × 11⅛")
5. **Effective Printing Width:** 202 mm (7⅞")
6. **Transmission Time*:** Approx. 8 s/page (Original mode)
Approx. 20 s/page (G3 Normal mode)
7. **Scanning Density:** Horizontal: 8 pels/mm (203 pels/inch)
Vertical: 3.85 lines/mm (98 lines/inch)—Standard mode
7.7 lines/mm (196 lines/inch)—Fine/Halftone mode
15.4 lines/mm (392 lines/inch)—Superfine mode
8. **Halftone Level:** 64-level
9. **Scanner Type:** CCD image sensor
10. **Printer Type:** Thermal printing
11. **Data Compression System:** Modified Huffman (MH), Modified READ (MR),
Modified Modified READ (MMR)
12. **Modem Speed:** 14400/12000/9600/7200/4800/2400 bps; Automatic Fallback
13. **Operating Environment:** 5–35 °C (41–95 °F), 20–80 % RH (Relative Humidity)
14. **Dimensions (H×W×D):** 149 × 367 × 355 mm (5⅞" × 14⅞" × 13⅜")
15. **Mass (Weight):** Approx. 5.2 kg (11.4 lb.)
16. **Power Consumption:** Standby: Approx. 7.0 W
Transmission: Approx. 16 W
Reception: Approx. 38 W
Copy: Approx. 52 W
Maximum: Approx. 160 W
17. **Power Supply:** 220–240 V AC, 50/60 Hz
18. **Memory Capacity:** Voice memory: Approx. 18 minutes of recording time including the greeting message.**
Fax memory***: Approx. 28 pages memory reception
Approx. 25 pages memory transmission

*Transmission speed depends on the contents of the pages, resolution, telephone line conditions and capability of the receiving unit. The 8 second speed is based upon the CCITT No.1 Test Chart.

**Recording time may be reduced by the calling party's background noise.

***Based on the CCITT No. 1 Test Chart in standard resolution when the Error Correction Mode is set to OFF.

Note:

- Any details given in these instructions are subject to change without notice.
- The pictures and illustrations in these instructions may vary slightly from the actual product.

CCITT No. 1 Test Chart

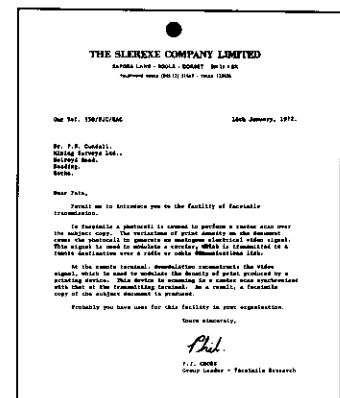

One-touch dialing list

Direct call Station No.	Name/Telephone No.	Direct call Station No.	Name/Telephone No.
1		10 (LOWER 1)	
2		11 (LOWER 2)	
3		12 (LOWER 3)	
4		13 (LOWER 4)	
5		14 (LOWER 5)	
6		15 (LOWER 6)	
7		16 (LOWER 7)	
8		17 (LOWER 8)	
9		18 (LOWER 9)	

Speed dialing list

Station No.	Name/Telephone No.	Station No.	Name/Telephone No.	Station No.	Name/Telephone No.
00		34		68	
01		35		69	
02		36		70	
03		37		71	
04		38		72	
05		39		73	
06		40		74	
07		41		75	
08		42		76	
09		43		77	
10		44		78	
11		45		79	
12		46		80	
13		47		81	
14		48		82	
15		49		83	
16		50		84	
17		51		85	
18		52		86	
19		53		87	
20		54		88	
21		55		89	
22		56		90	
23		57		91	
24		58		92	
25		59		93	
26		60		94	
27		61		95	
28		62		96	
29		63		97	
30		64		98	
31		65		99	
32		66			
33		67			

Index

- A** Address Book 79, 88, 91
 - Advanced features 58
 - Resetting 73
 - ALL MESSAGES button 26, 27
 - ANS/FAX mode 22, 24
 - ANS/FAX ring count..... 59
 - Automatic dialing 33, 34
 - AUTO RECEIVE button 22, 24
 - AUTO RECEIVE mode 22, 24, 29

- B** Basic features 58
 - BROADCAST key 41, 42

- C** Call counter 26
 - Caller's recording time..... 62
 - CHECK button 48
 - Cleaning 105
 - Communication messages 77
 - Copier 79, 91
 - COPY button 18
 - Cover page 43

- D** Date and time 13
 - Delayed transmission 39
 - DELETE key 14
 - DIGITAL SP-PHONE button 16
 - Direct call station keys 14, 33, 34
 - DIRECTORY button 34, 35
 - Display contrast 67
 - Distinctive ring service..... 46
 - Document jam 102
 - Document size 106
 - Documents (the unit can feed) 19

- E** ECM communication 73
 - Electronic telephone directory 35
 - ERASE button 26, 48
 - Error message 93, 94
 - Extension copy 56

- F** Facsimile telephone number 15
 - FaxAbility 46
 - Fax auto redial 34
 - FAX mode 22, 29
 - Fax pager 71
 - FAX ring count 60
 - Fax voice guidance 20, 21, 23, 69
 - Feature list..... 74

- Feeder pressure 102
- Film detection 72
- Film/Film cartridge, replacing 103, 104
- Film/Paper save reception 65
- FILM REMAINING button 103
- Finder 79, 92
- Friendly reception 23, 69

- G** Greeting messages 47

- H** HELP button 12
 - HYPHEN key 14

- I** ICM monitor 70
 - INSERT key 14

- J** Journal auto print 75
 - Journal report 74, 76
 - Junk mail prohibitor 45

- L** Launch pad 79, 92
 - Logo 14
 - Logo print position 63
 - LOWER key 33, 34

- M** MANUAL RECEIVE mode 22, 31
 - Memory reception alert 68
 - Memory transmission 40
 - MEMO/2WAY REC button 28
 - Message alert 67
 - Message Center 79, 84, 92
 - Message transfer 50
 - Multi Transmission report 42
 - MUTE button 16

- N** NEW MESSAGES button 26, 27

- O** One-touch dialing 33, 34
 - Overseas transmission mode..... 64

- P** PAUSE button 37
 - PC Link 90
 - Polling 38
 - Power down report 97

- Q** QUICK button 27

Index (cont.)

- R** RECALL button 37
- REC button 47
- Receiving reduction 66
- Recording paper jam 100, 101
- Recording paper size 8, 106
- Recording time alert 68
- Recording time for
 - ANS/FAX greeting message 70
- REDIAL button 37
- Reduction copy 57
- Remote fax activation code 44
- Remote operation ID 52
- REPEAT button 27
- Reserving transmission 43
- RESOLUTION button 18
- Ring pattern detection 46

- S** SECRET key 14, 33
- SELECT button 47, 48
- Send From Fax 79, 87, 92
- Silent fax recognition ring 62
- SKIP button 27
- SLOW button 27
- SPACE key 14
- Speed dialing 33, 34
- Summary of user
 - programmable features 58

- T** Telephone number list 74
- TEL mode 22, 23
- TEL/FAX mode 22, 30, 31
- TEL/FAX ring count 61
- Toll saver 59
- Transmission report 75, 76

- V** Viewer 79, 91
- Voice contact 36
- Voice guide 21
- Voice time/day stamp 26
- VOLUME button 13, 16, 17

For your future reference

Date of purchase

Serial No.

(found on the bottom of the unit)

Dealer's name and address

Dealer's telephone number

Kyushu Matsushita Electric Co., Ltd.

1-62, 4-chome, Minoshima, Hakata-ku, Fukuoka 812, Japan

Printed in Malaysia

PFQX1161YA KF1097AN2107 ©

Free Manuals Download Website

<http://myh66.com>

<http://usermanuals.us>

<http://www.somanuals.com>

<http://www.4manuals.cc>

<http://www.manual-lib.com>

<http://www.404manual.com>

<http://www.luxmanual.com>

<http://aubethermostatmanual.com>

Golf course search by state

<http://golfingnear.com>

Email search by domain

<http://emailbydomain.com>

Auto manuals search

<http://auto.somanuals.com>

TV manuals search

<http://tv.somanuals.com>