

# Panasonic

## Compact Plain Paper Fax Operating Instructions

---

Model No. **KX-FHD301**



### FOR FAX ADVANTAGE ASSISTANCE:

– CALL

*1-800-HELP-FAX (1-800-435-7329)*

– E-MAIL TO

*consumerproducts@panasonic.com*

for customers in the U.S.A. or Puerto Rico

– REFER TO

*www.panasonic.com*

for customers in the U.S.A. or Puerto Rico

Please read these Operating Instructions before using the unit and save for future reference.

**This model is designed to be used only in the U.S.A.**

Thank you for purchasing a Panasonic facsimile.

## Things you should keep a record of

Attach your sales receipt here

### For your future reference

Date of purchase

Serial number

(found on the rear of the unit)

Dealer's name and address

Dealer's telephone number

### Caution:

- The Telephone Protection Act of 1991 requires the following information to be clearly stated either at the top or bottom margin of the first message page when transmitting messages via telephone facsimile:
  - date and time of transmission,
  - identification of the business, entity or person(s) sending the facsimile, and
  - telephone number of the business, entity or person(s).To program this information into your unit, complete all the instructions on pages 15 to 18.
- Note that the images of copied or received documents will remain on the used ink film. Use discretion when disposing of the used ink film.
- Do not rub or use an eraser on the printed side of recording paper, as the print may smear.

### Energy Star

As an ENERGY STAR® Partner, Panasonic has determined that this product meets the ENERGY STAR guidelines for energy efficiency. ENERGY STAR is a U.S. registered mark.



### Trademarks

Hammermill® is a registered trademark of INTERNATIONAL PAPER in the United States and/or other countries.

All other trademarks identified herein are the property of their respective owners.

### Copyright:

This manual is copyrighted by Kyushu Matsushita Electric Co., Ltd. (KME) and its licensee. Under the copyright laws, this manual may not be reproduced in any form, in whole or part, without the prior written consent of KME and its licensee.

© Kyushu Matsushita Electric Co., Ltd. 2001

## Important safety instructions

When using this unit, basic safety precautions should always be followed to reduce the risk of fire, electric shock, or personal injury.

1. Read and understand all instructions.
2. Follow all warnings and instructions marked on this unit.
3. Unplug this unit from power outlets before cleaning. Do not use liquid or aerosol cleaners. Use a damp cloth for cleaning.
4. Do not use this unit near water, for example near a bathtub, wash bowl, kitchen sink, or the like.
5. Place the unit securely on a stable surface. Serious damage and/or injury may result if the unit falls.
6. Do not cover slots and openings on the unit. They are provided for ventilation and protection against overheating. Never place the unit near radiators, or in a place where proper ventilation is not provided.
7. Use only the power source marked on the unit. If you are not sure of the type of power supplied to your home, consult your dealer or local power company.
8. For safety purposes this unit is equipped with a grounded plug. If you do not have this type of outlet, please have one installed. Do not use any type of adaptor plug to defeat this safety feature.
9. Do not place objects on the power cord. Install the unit where no one can step or trip on the cord.
10. Do not overload wall outlets and extension cords. This can result in the risk of fire or electric shock.
11. Never push any objects through slots in this unit. This may result in the risk of fire or electric shock. Never spill any liquid on the unit.
12. To reduce the risk of electric shock, do not disassemble this unit. Take the unit to an authorized service center when service is required. Opening or removing covers may expose you to dangerous voltages or other risks. Incorrect reassembly can cause electric shock when the unit is subsequently used.
13. Unplug this unit from the wall outlet and refer servicing to an authorized service center when the following conditions occur:
  - A. When the power supply cord or plug is damaged or frayed.

- B. If liquid has been spilled into the unit.
  - C. If the unit has been exposed to rain or water.
  - D. If the unit does not work normally by following the operating instructions. Adjust only controls covered by the operating instructions. Improper adjustment may require extensive work by an authorized service center.
  - E. If the unit has been dropped or physically damaged.
  - F. If the unit exhibits a distinct change in performance.
14. During thunderstorms, avoid using telephones except cordless types. There may be a remote risk of an electric shock from lightning.
  15. Do not use this unit to report a gas leak, when in the vicinity of the leak.

## SAVE THESE INSTRUCTIONS

### INSTALLATION:

- Never install telephone wiring during a lightning storm.
- Never install telephone jacks in wet locations unless the jack is specifically designed for wet locations.
- Never touch uninsulated telephone wires or terminals unless the telephone line has been disconnected at the network interface.
- Use caution when installing or modifying telephone lines.

### WARNING:

- To prevent the risk of fire or electrical shock, do not expose this product to rain or any type of moisture.

### OTHER INFORMATION:

- Keep the unit away from electrical noise generating devices, such as fluorescent lamps and motors.
- The unit should be kept free from dust, high temperature and vibration.
- The unit should not be exposed to direct sunlight.
- Do not place heavy objects on top of this unit.
- Do not touch the plug with wet hands.

# Table of Contents

## Initial Preparation

<b>Accessories</b>	Included accessories . . . . .	6
	Accessory information . . . . .	7
<b>Help Button</b>	Help function . . . . .	8
<b>Finding the Controls</b>	Location . . . . .	9
	Overview . . . . .	10
<b>Setup</b>	Before installation . . . . .	10
	Paper stacker . . . . .	11
	Paper tray . . . . .	12
	Recording paper . . . . .	13
	Connections . . . . .	14
	Date and time, your logo and facsimile telephone number . . . . .	15
<b>Volumes</b>	Adjusting volumes . . . . .	19

## Telephone

<b>Automatic Dialing</b>	Storing names and telephone numbers in one-touch dial . . . . .	20
	Storing names and telephone numbers in navigator directory . . . . .	21
	Editing and erasing a stored item . . . . .	22
	Making a phone call using one-touch dial and navigator directory . . . . .	23
<b>Caller ID</b>	Caller ID service from your phone company . . . . .	24
	Viewing and calling back using caller information . . . . .	25
	Confirming caller information using the Caller ID list . . . . .	26
	Storing caller information in one-touch dial and navigator directory . . . . .	27
<b>Voice Contact</b>	Talking to the other party after fax transmission or reception . . . . .	28

## Fax

<b>Sending Faxes</b>	Sending a fax manually . . . . .	29
	Documents you can send . . . . .	30
	Sending a fax using one-touch dial and navigator directory . . . . .	31
	One time broadcast transmission . . . . .	32
	Broadcast transmission to pre-programmed parties . . . . .	33
<b>Receiving Faxes</b>	Setting the unit to receive faxes . . . . .	36
	TEL mode (answering all calls manually) . . . . .	38
	FAX ONLY mode (all calls are received as faxes) . . . . .	39
	TEL/FAX mode (receiving phone calls with ring signals and faxes without ring signals when you are near the unit) . . . . .	40
	Using the unit with an answering machine . . . . .	42
	Extension telephone . . . . .	43
	Pager call - when the unit receives a fax . . . . .	44
<b>Distinctive Ring</b>	Using with a voice mail service . . . . .	45

## Copy

<b>Copying</b>	Making a copy . . . . .	46
	Convenient way to make a copy . . . . .	47

## Programmable Features

<b>Features</b>	Programming . . . . .	49
<b>Summary</b>	Basic features . . . . .	50
	Advanced features . . . . .	52

## Help





<b>Error Messages</b>	Reports . . . . .	56
	Display . . . . .	57
<b>Operations</b>	When a function does not work, check here before requesting help . . . . .	59
	If a power failure occurs . . . . .	63
<b>Replacement</b>	Replacing the film cartridge . . . . .	64
<b>Jams</b>	Recording paper jam . . . . .	65
	Document jams – sending . . . . .	67
<b>Cleaning</b>	Document feeder . . . . .	68
	Thermal head, bar and projection bar . . . . .	68

## General Information

<b>Printed Reports</b>	Reference lists and reports . . . . .	69
<b>FCC Information</b>	List of FCC requirements and information . . . . .	70
<b>Limited Warranty</b>	PANASONIC Facsimile Products Limited Warranty . . . . .	71
<b>Servicenter Directory</b>	Servicenter directory . . . . .	72
<b>Specifications</b>	Technical data about this product . . . . .	73
<b>Index</b>	Index . . . . .	74

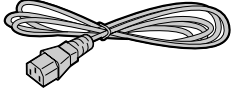
# Accessories

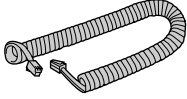
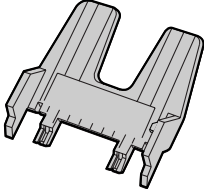
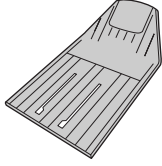
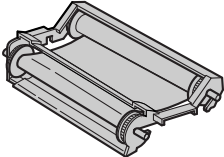
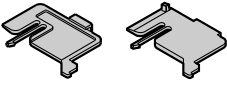
## Included accessories

Power cord ..... 1  Part No. PFJA1030Z	Telephone line cord ..... 1  Part No. PQJA10075Z	Handset ..... 1  Part No. PFJXE0805Z
Handset cord ..... 1  Part No. PFJA1029Z	Paper tray ..... 1  Part No. PFZX2FHD301M	Paper stacker ..... 1  Part No. PFZX1FHD301M
Film cartridge ..... 1 (included film)  — The film cartridge is pre-installed.	A4 paper guides ..... 2  (Left) (Right) (Left) Part No. PFKS1032Z3 (Right) Part No. PFKS1033Z3	Operating instructions ..... 1  Part No. PFQX1580Z

- If any item is missing or damaged, check with the place of purchase.
- The part numbers listed above are subject to change without notice.
- Save the original carton and packing materials for future shipping and transportation of the unit.

## Accessory information

- The included film cartridge is 10 meters (32½') long. We recommend that you buy full size replacement film cartridge – 100 meters (328') for continuous use of your unit. For best results, use genuine Panasonic replacement film cartridge Model No. KX-FA65.

Model No.	Item	Specifications
KX-FA65	Film cartridge	216 mm x 100 m (8½" x 328') (prints about 330 letter size pages)

- **The film cartridge is not reusable. Do not rewind and use the ink film again.**
- To place an order:
  - Telephone:** Call 1-800-332-5368.
  - Fax:** Send a fax to 1-800-237-9080.
    - Include: — your name, shipping address and telephone number,
    - credit card type, number, expiration date and your signature,
    - order part number and quantity.
  - Internet:** Visit our web site: <http://www.panasonic.com/store>  
(for customers in the U.S.A. or Puerto Rico ONLY)
- If you have any questions about internet orders, please contact us at:
  - E-mail:** [panasonicdirect@panasonic.com](mailto:panasonicdirect@panasonic.com)
  - Telephone:** 1-201-348-7292

# Help Button

## Help function

You can print a quick reference for assistance as follows.

**1** Press **HELP**.

Display: 

PRESS NAVI. [◀ ▶] & SET
----------------------------

**2** Press **◀** or **▶** until the desired item is displayed.

1. How to set the date, time, your logo and fax number.

QUICK SET UP PRESS SET
---------------------------

2. How to program the features.

FEATURE LIST PRESS SET
---------------------------

3. How to store names in the navigator directory and how to dial them.

DIRECTORY PRESS SET
------------------------

4. Help with problems sending/receiving faxes.

FAX SND/RCV PRESS SET
--------------------------

5. How to use the copier function.

COPIER PRESS SET
---------------------

6. Frequently asked questions and answers.

Q and A PRESS SET
----------------------

7. Explanation of error messages shown on the display.

ERRORS PRESS SET
---------------------

8. List of available reports.

REPORTS PRESS SET
----------------------

9. How to use the Caller ID service.

CALLER ID PRESS SET
------------------------

**3** Press **SET**.

PRINTING
----------

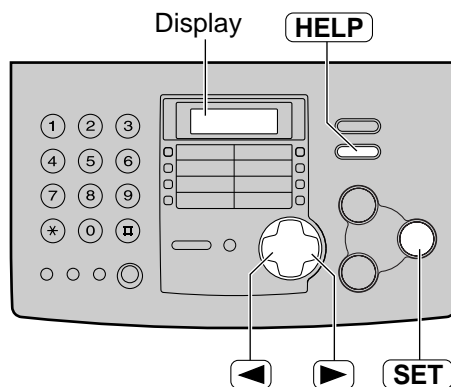



## Location

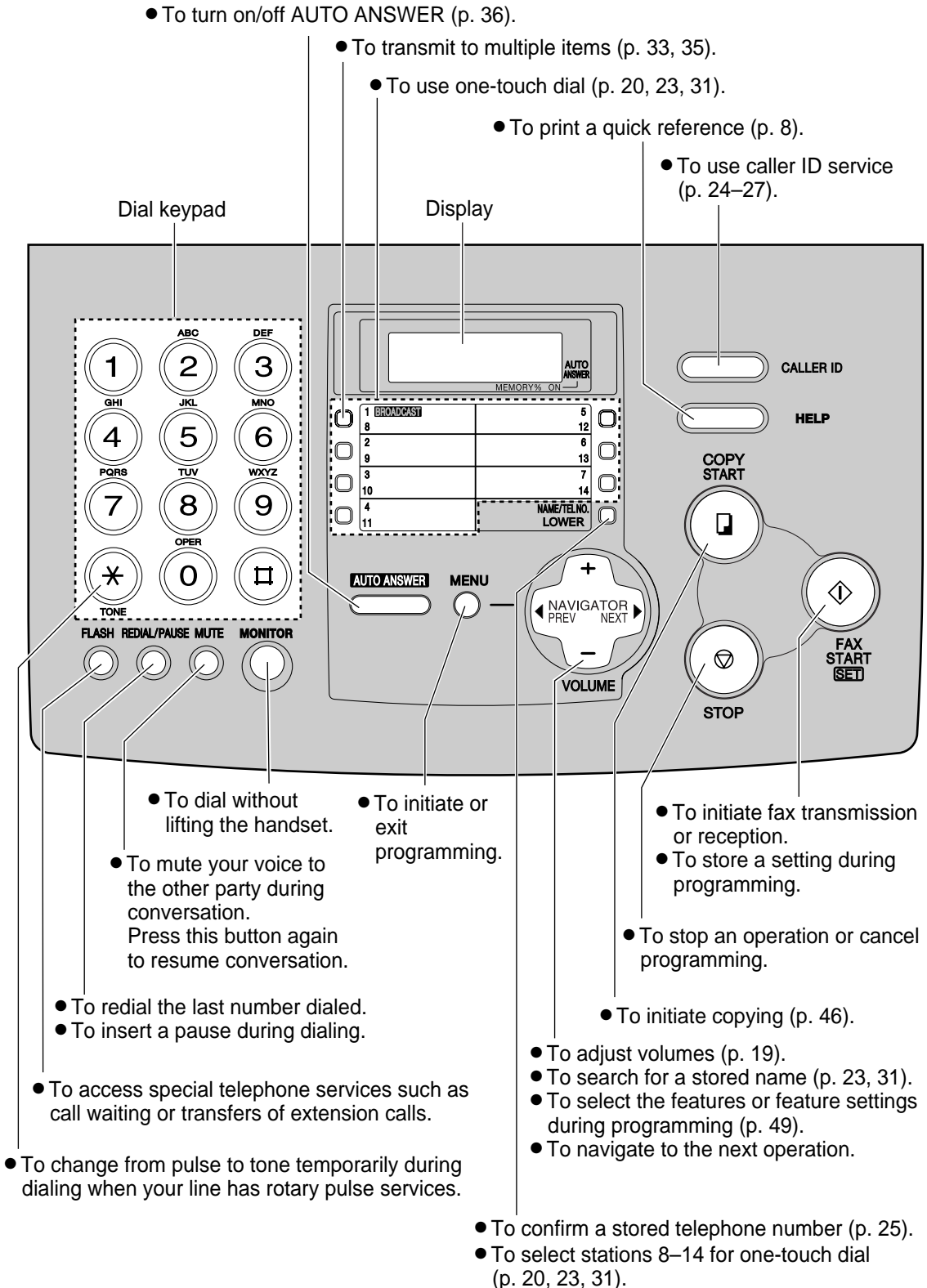

# Finding the Controls / Setup

## Overview

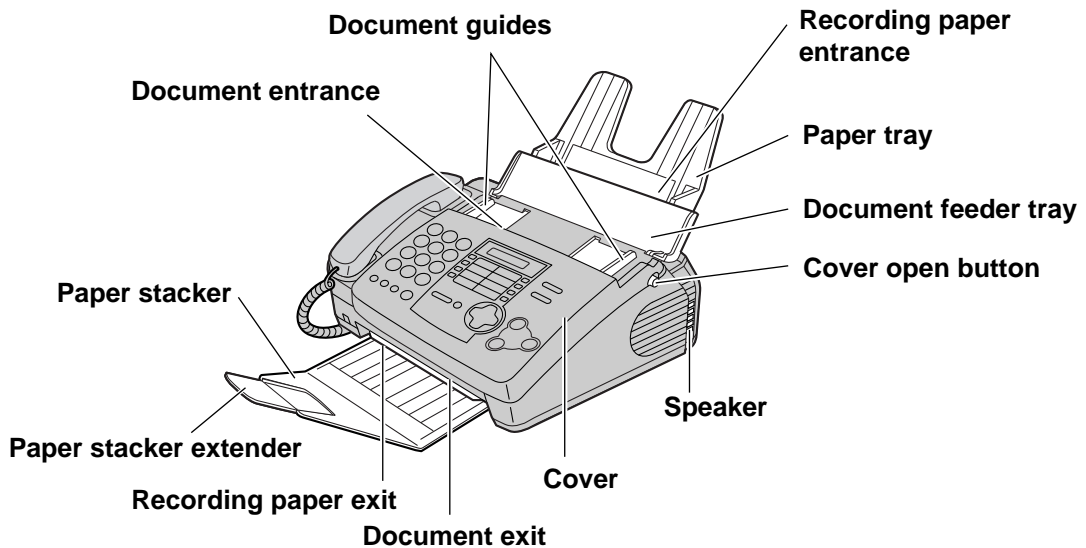

### Note:

- The document and recording paper will be ejected from the front of the unit. Install the unit on a desk or floor with a smooth surface and do not place anything in front of the unit.
- Do not reinsert the ejected paper into the recording paper exit.
- The paper stacker may not be shown in all instructions.

## Before installation

- 1 Remove the shipping tape.

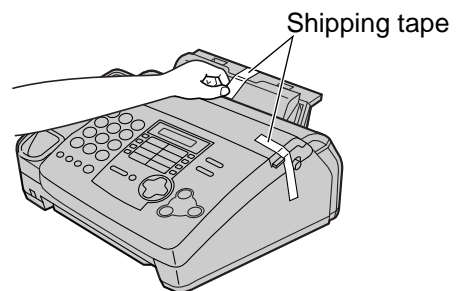

- 2 Open the cover by pressing the cover open button.

- 3 Lift the film cartridge, remove the leaflet and replace the film cartridge.

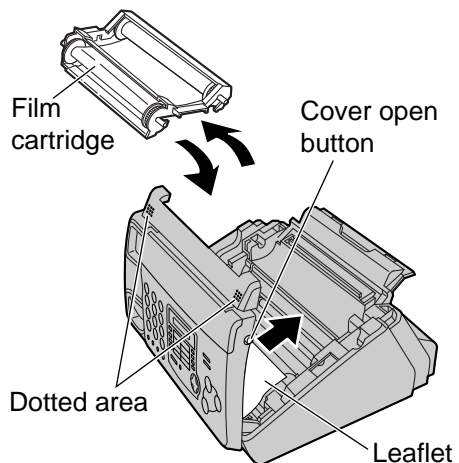

- 4 Close the cover securely by pushing down on the dotted area at both ends.

## Paper stacker

---

---

- 1** Remove the shipping tape from the paper stacker.
- 2** Lift the front of the unit and hold the aluminum sheet up to prevent it being bent by the paper stacker while inserting the paper stacker into the side slots.
- 3** Confirm that the paper stacker is locked into the center slots and slide back.
- 4** Slide the paper stacker forward until it stops.

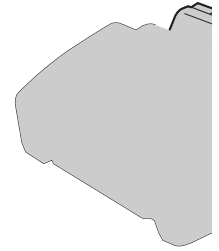

# Setup

## Paper tray

Insert the two tabs on the paper tray into the slots on the back of the unit.

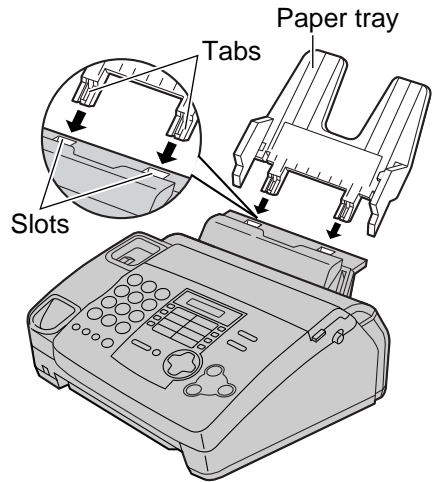

### Note:

- Do not place the unit in areas where the paper tray may be obstructed by a wall, etc.

### To use A4 size paper

- Install the A4 paper guides to the paper tray (see below).
- Set the recording paper size (feature #16 on page 51).

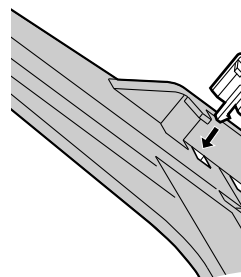
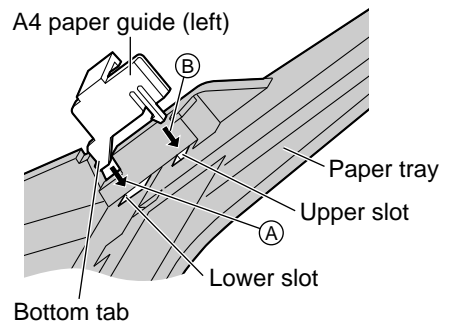
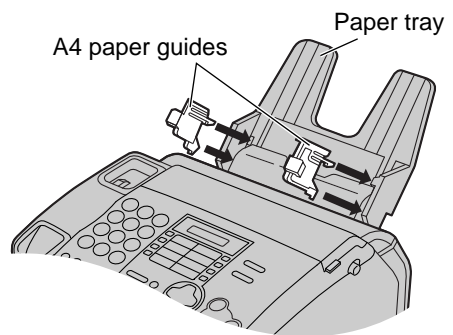

### Note:

- When you remove the paper tray, be sure to take off A4 paper guides first, in order not to damage them.

## Recording paper

Letter, legal or A4 size recording paper can be loaded. The unit can hold up to 150 sheets of 75 g/m<sup>2</sup> (20 lb.) paper. You may use 60 g/m<sup>2</sup> to 90 g/m<sup>2</sup> (16 lb. to 24 lb.) paper.

**For best results, only use inkjet paper such as Hammermill Jet Print. If you use other types of paper, the print quality may be affected.**

To use A4 size paper, see page 12.

- 1** Fan the stack of paper to prevent a paper jam.
- 2** Pull the tension bar forward and hold open while inserting the paper.
  - The height of the stack of the paper should not exceed the upper limit on the paper tray, otherwise the paper may jam or multi-feed.
  - The paper should not be over the tab.
  - If the paper is not inserted correctly, readjust the paper, or the paper may jam.

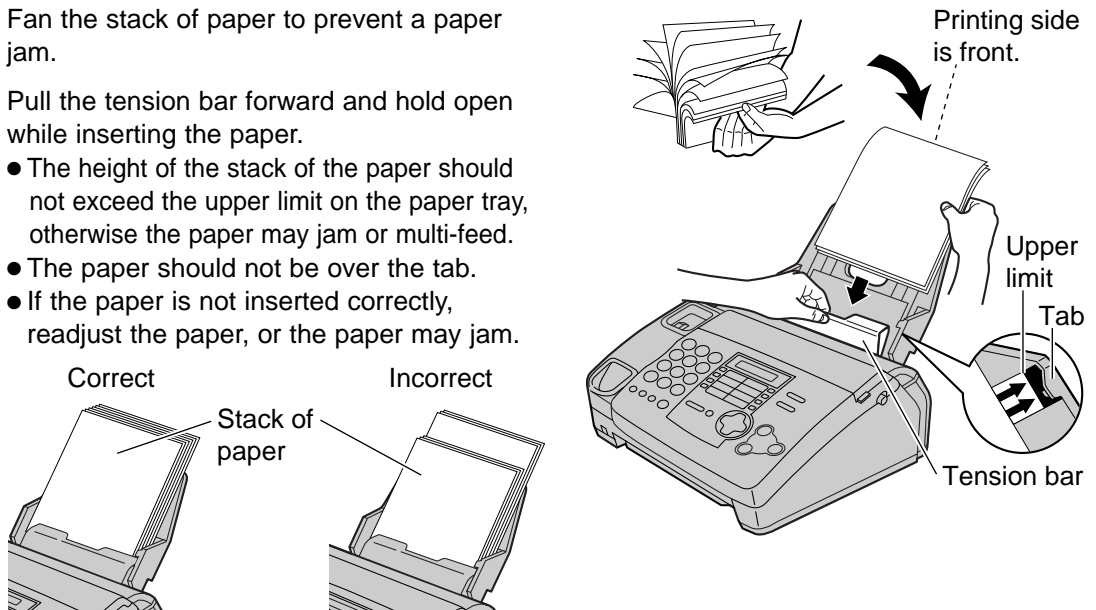

### Note for recording paper:

- Avoid using paper with a cotton and/or fiber content that is over 20%, such as letterhead paper or paper used for resumes.
- Do not use different types or thicknesses of paper at the same time. This may cause a paper jam.
- Avoid extremely smooth or shiny paper that is highly textured.
- Avoid paper that is coated, damaged or wrinkled.

### Note:

- Avoid double-sided printing.
- Do not use paper printed from this unit for double-sided printing with other copiers or printers, or the paper may jam.
- Some paper only accepts print on one side. Try using the other side of paper if you are not happy with the print quality.

### Adding paper

1. Pull the tension bar forward and hold open while removing all of the installed paper.
2. Add paper to the removed paper and straighten.
3. Fan the stack of paper.
4. Pull the tension bar forward and hold open while inserting the paper.

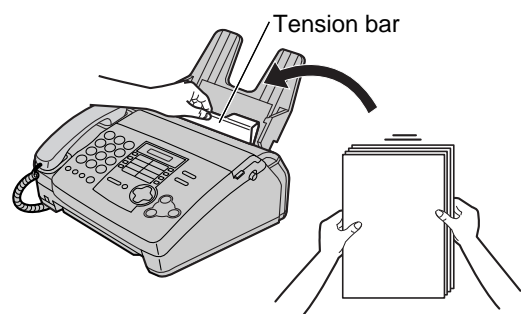

## Connections

- 1 Connect the handset cord.
- 2 Connect the telephone line cord.
- 3 Connect the power cord.

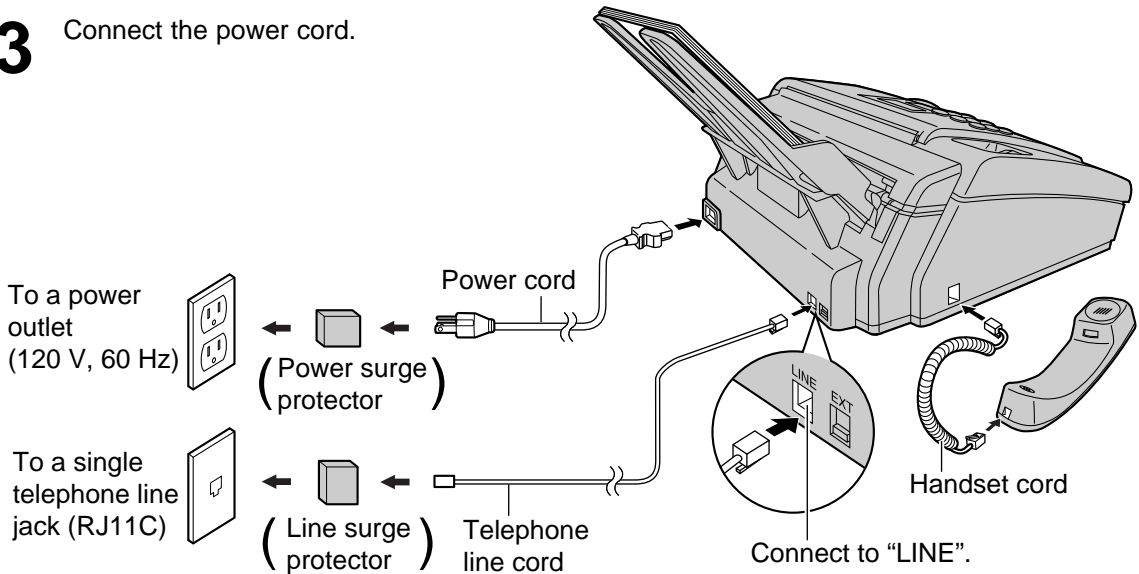

### Caution:

- When you operate this product, the power outlet should be near the product and easily accessible.

### Note:

- For additional equipment protection, we recommend you use a surge protector. The following types are available: TELESPIKE BLOK MODEL TSB (TRIPPE MFG. CO.), SPIKE BLOK MODEL SK6-0 (TRIPPE MFG. CO.), SUPER MAX (PANAMAX) or MP1 (ITW LINX).  
The warranty does not cover damage due to power line surges or lightning.
- If you want to connect an answering machine to the unit, see page 42.

### To use the fax machine with a computer on the same line

- We recommend you use separate wall jacks for the fax machine and the computer.
- Set the fax machine to TEL mode (p. 38).
- The device which has the shortest ring setting will answer the call first.
- If the computer provides a port for telephone line, connect the fax machine to the port on the computer.

## Date and time, your logo and facsimile telephone number

You should program the date and time, your logo and facsimile telephone number. This information will be printed on each page transmitted from your unit.

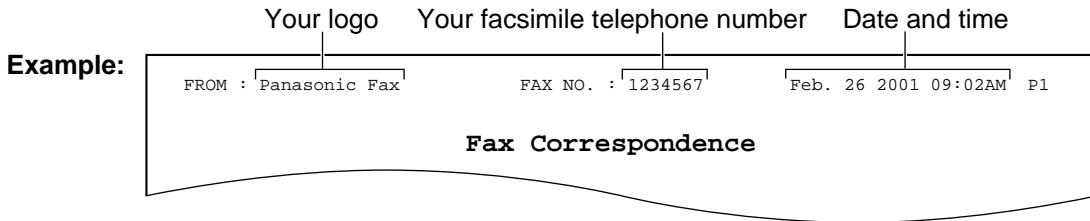

### Setting the date and time

**1** Press **MENU**.

Display: SYSTEM SET UP  
PRESS NAVI. [◀ ▶]

**2** Press **◀** or **▶** until the following is displayed.

SET DATE & TIME  
PRESS SET

**3** Press **SET**.

Cursor  
Example: M: 01/D: 01/Y: 01  
TIME: 12:00AM

**4** Enter the correct month/day/year by selecting 2 digits for each, using the dial keypad.

**Example:** Aug. 10, 2001

Press **081001**.

M: 08/D: 10/Y: 01  
TIME: 12:00AM

**5** Enter the correct hour/minute by selecting 2 digits for each, using the dial keypad.

Press **\*** to select "AM" or "PM".

**Example:** 3:15PM

1. Press **0315**.

M: 08/D: 10/Y: 01  
TIME: 03:15AM

2. Press **\*** until "PM" is displayed.

M: 08/D: 10/Y: 01  
TIME: 03:15PM

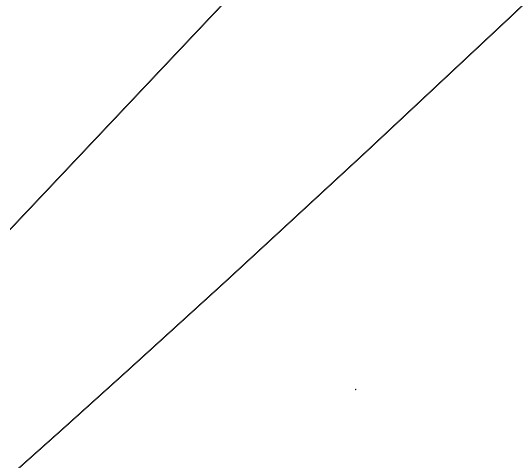
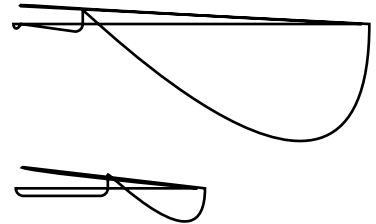

# Setup

## Setting your logo

The logo can be your company, division or name.

**1** Press **MENU**.

Display: SYSTEM SET UP  
PRESS NAVI. [◀ ▶]

**2** Press **◀** or **▶** until the following is displayed.

YOUR LOGO  
PRESS SET

**3** Press **SET**.

LOGO=

**4** Enter your logo, up to 30 characters, using the dial keypad. See the next page for details.

**Example:** "Bill"

1. Press **2** twice.

Cursor  
LOGO=B

2. Press **4** six times.

LOGO=Bi

3. Press **5** six times.

LOGO=Bill

4. Press **▶** to move the cursor to the next space and press **5** six times.

LOGO=Bill

**5** Press **SET**.

• The next feature will be displayed.

YOUR FAX NO.  
PRESS SET

**6** Press **MENU**.

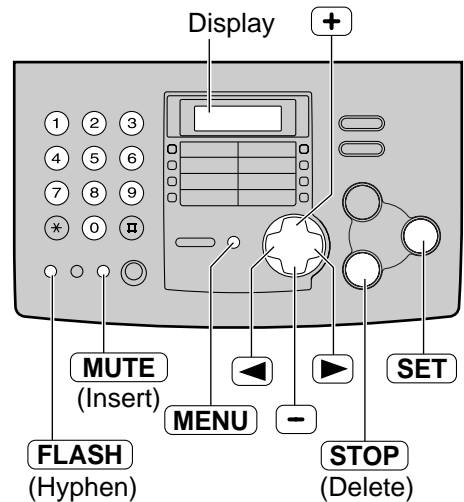

### Note:

- You can enter your logo by pressing **+** or **-** (see the next page) in step 4. In this case, press **▶** to move the cursor.

### To correct a mistake

- Press **◀** or **▶** to move the cursor to the incorrect character, and make the correction.

### To delete a character

- Move the cursor to the character you want to delete and press **STOP**.



### To insert a character

1. Press **◀** or **▶** to move the cursor to the position to the right of where you want to insert the character.
2. Press **MUTE** (Insert) to insert a space and enter the character.







## To select characters with the dial keypad

Pressing the dial keys will select a character as shown below.

Keys	Characters
①	1 [ ] { } + - / = , . _ ` : ; ?
②	A B C a b c 2
③	D E F d e f 3
④	G H I g h i 4
⑤	J K L j k l 5
⑥	M N O m n o 6
⑦	P Q R S p q r s 7
⑧	T U V t u v 8
⑨	W X Y Z w x y z 9
⑩	0 ( ) < > ! " # \$ % & ¥ * @ ^ ' →
<b>FLASH</b>	<b>Hyphen</b> button (To insert a hyphen.)
<b>MUTE</b>	<b>Insert</b> button (To insert one character or one space.)
<b>STOP</b>	<b>Delete</b> button (To delete a character.)
	▶ key (To move the cursor to the right.) To enter another character using the same number key, move the cursor to the next space.
	◀ key (To move the cursor to the left.)

## To select characters using or

Instead of pressing the dial keys, you can select characters using  or .

1. Press  or  until the desired character is displayed.
2. Press  to move the cursor to the next space.
  - The character displayed in step 1 is inserted.
3. Return to step 1 to enter the next character.

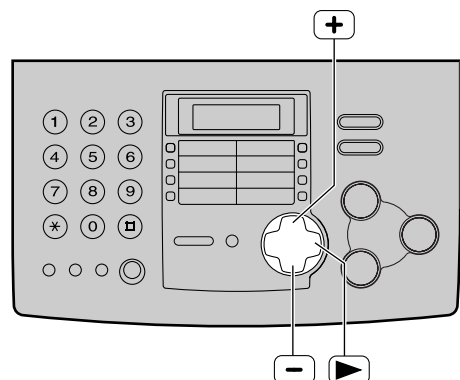

## Display order of characters

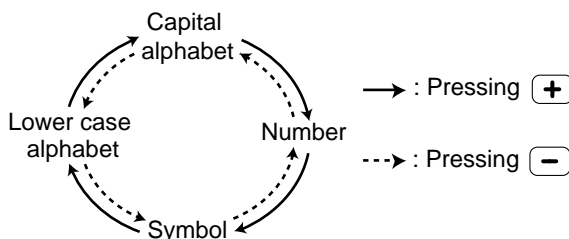

# Setup

## Setting your facsimile telephone number

**1** Press **MENU**.  
Display: SYSTEM SET UP  
PRESS NAVI. [◀ ▶]

**2** Press **◀** or **▶** until the following is displayed.  
YOUR FAX NO.  
PRESS SET

**3** Press **SET**.  
NO. =

**4** Enter your facsimile telephone number, up to 20 digits, using the dial keypad.  
Example: NO. =1234567

**5** Press **SET**.  
• The next feature will be displayed.  
SENDING REPORT  
MODE=ERROR [±]

**6** Press **MENU**.

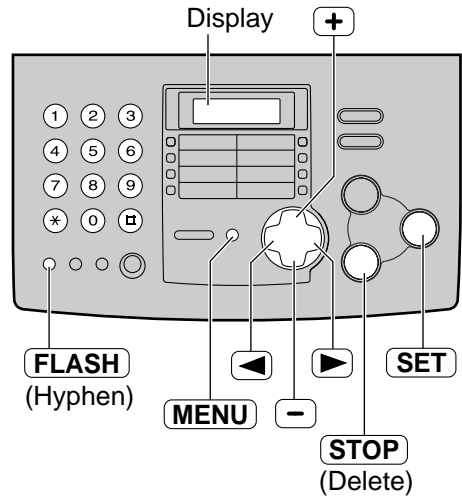

### Note:

- You can enter your facsimile telephone number by pressing **+** or **-** in step 4. If you use **+** or **-**, press **▶** to move the cursor.
- The **\*** button replaces the digit with a "+" and the **#** button replaces it with a space.

**Example** (using the dial keypad): +234 5678

Press **\*234#5678**.

- To enter a hyphen in a telephone number, press **FLASH** (Hyphen).

### To correct a mistake

- Press **◀** or **▶** to move the cursor to the incorrect number, and make the correction.

### To delete a number

- Move the cursor to the number you want to delete and press **STOP**.

## Adjusting volumes

### Ringer volume

4 levels (high/middle/low/off) are available.

**While the unit is idle**, press **+** or **-**.

- If any documents are in the document entrance, you cannot adjust the ringer volume. Confirm that there are no documents in the document entrance.

#### To turn the ringer off:

1. Press **-** repeatedly until the following is displayed.

Display: 

RINGER OFF= OK?
YES: SET/NO: STOP

2. Press **SET**.

- To turn the ringer back on, press **+**.

#### While the ringer volume is set to off:

The display will show the following.

RINGER OFF
------------

When a call is received, the unit will not ring and will display the following.

INCOMING CALL
---------------

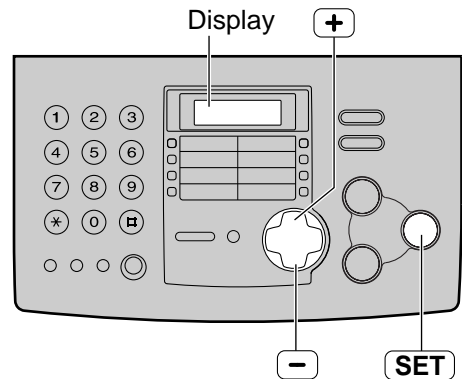

### Ringer pattern

- You can select one of the three ringer patterns. Change the setting (feature #17 on page 51). The ringer pattern you selected will sound when the unit receives a call.

### Handset receiver volume

5 levels (high to low) are available.

**While using the handset**, press **+** or **-**.

### Monitor volume

8 levels (high to low) are available.

**While using the monitor**, press **+** or **-**.

# Automatic Dialing

## Storing names and telephone numbers in one-touch dial

For rapid access to frequently dialed numbers, the unit provides 14 stations for one-touch dial.

- Station 1 can be alternatively used as a broadcast key (p. 33).

**1** Press **MENU** twice.

Display: `DIRECTORY SET  
PRESS STATION OR`  
↕  
`DIRECTORY SET  
PRESS NAVI .`

**2** For station 1:  
Press station 1 key.

`STATION 1  
DIAL MODE [±]`

Press **SET** to go to the next prompt.

**For stations 2–7:**

Press one of the station keys.

**For stations 8–14:**

Press **LOWER**, then press one of the station keys.

**3** Enter the name, up to 10 characters (see page 17 for instructions).

Example: `NAME=John  
STORE:PRESS SET`

**4** Press **SET**.

Example: `<S02>=`

**5** Enter the telephone number, up to 30 digits, using the dial keypad.

Example: `<S02>=1114497`

- If you want to enter a hyphen, press **FLASH**.

**6** Press **SET**.

`REGISTERED`  
↓  
`DIRECTORY SET  
PRESS STATION OR`  
↕  
`DIRECTORY SET  
PRESS NAVI .`

- To program other stations, repeat steps 2 to 6.

**7** Press **STOP** to exit the program.

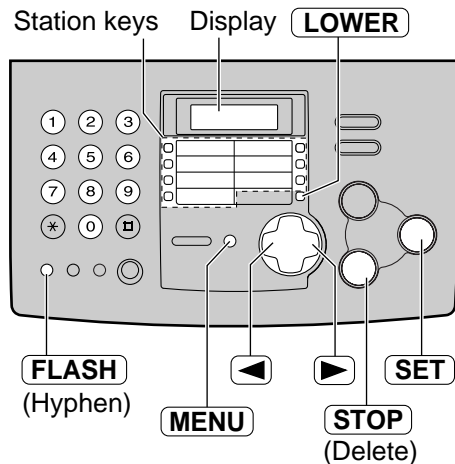

### Helpful hint:

- You can confirm the stored stations on the telephone number list (p. 69).

### Note:

- A hyphen or a space entered in a telephone number counts as two digits.

### To correct a mistake

- Press **←** or **→** to move the cursor to the incorrect character/number, and make the correction.

### To delete a character/number

- Move the cursor to the character/number you want to delete, and press **STOP**.

## Storing names and telephone numbers in navigator directory

For rapid access to frequently dialed numbers, the unit provides the navigator directory (100 items).

For your convenience, the following item has been pre-programmed.

**HELP-FAX (1-800-435-7329):** If you cannot correct a problem after trying the help function (p. 8), call using this item (p. 23).

- If you do not need the above item, you can erase it (p. 22).

**1** Press **MENU** twice.

Display: 

DIRECTORY SET PRESS STATION OR
-----------------------------------

  
↕  

DIRECTORY SET PRESS NAVI.
------------------------------

**2** Press **▶**.

NAME= STORE:PRESS SET
--------------------------

**3** Enter the name, up to 10 characters (see page 17 for instructions).

Example: 

NAME=Alice STORE:PRESS SET
-------------------------------

**4** Press **SET**.

NO. =
-------

**5** Enter the telephone number, up to 30 digits, using the dial keypad.

Example: 

NO. =5552233
--------------

- If you want to enter a hyphen, press **FLASH**.

**6** Press **SET**.

REGISTERED
------------

  
↓  

NAME= STORE:PRESS SET
--------------------------

- To program other items, repeat steps 3 to 6.

**7** Press **MENU** to exit the program.

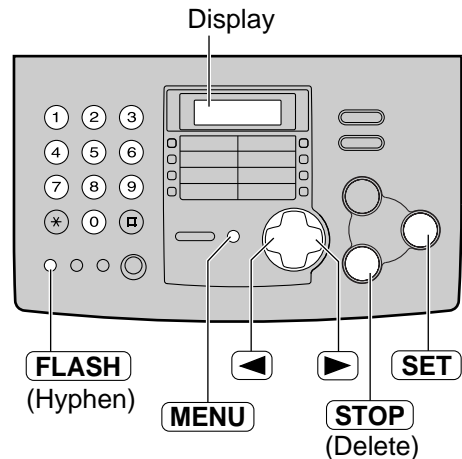

### Helpful hint:

- You can confirm the stored items on the telephone number list (p. 69).

### Note:

- When the following is displayed in step 6, you can store only 5 more items.

Display: 

REGISTERED SPACE= 5 DIRS.
------------------------------

- If there is no space to store new items, the following is displayed in step 6.

REGISTERED DIRECTORY FULL
------------------------------

Press **STOP** to exit the program.

To store new items, erase unnecessary items (p. 22).

- A hyphen or a space entered in a telephone number counts as two digits.

### To correct a mistake

- Press **◀** or **▶** to move the cursor to the incorrect character/number, and make the correction.

### To delete a character/number

- Move the cursor to the character/number you want to delete, and press **STOP**.

# Automatic Dialing

## Editing and erasing a stored item

### Editing a stored item

You can edit a name or number stored in one-touch dial and navigator directory.

**1** Press **▶**.

Display: DIRECTORY[+ -]

**2** Press **+** or **-** until the desired item is displayed.

means the station number for one-touch dial

Example: 

Mary	<S02>
0123456	

Mary	<S02>
EDIT:PRESS MENU	

**3** Press **MENU**.

Example: 

NAME=Mary
EDIT=* DELETE=#

**4** Press **\*** to select "EDIT".

Example: 

NAME=Mary
STORE:PRESS SET

- If you do not need to edit the name, skip to step 6.

**5** Edit the name (see page 17 for instructions).

**6** Press **SET**.

Example: 

<S02>=0123456
---------------

- If you do not need to edit the telephone number, skip to step 8.

**7** Edit the telephone number. For further details, see page 21.

**8** Press **SET**.

REGISTERED

**9** Press **STOP** to exit the program.

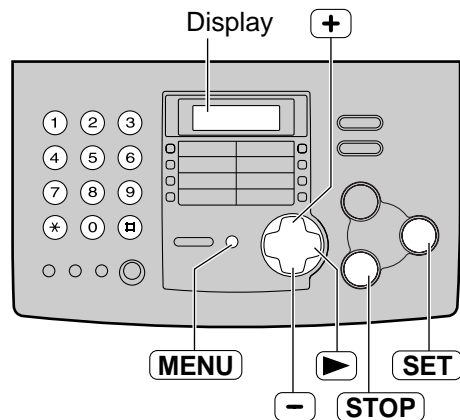

### Erasing a stored item

You can erase an item stored for one-touch dial and navigator directory.

**1** Press **▶**.

Display: DIRECTORY[+ -]

**2** Press **+** or **-** until the desired item is displayed.

Example: 

Peter
9876543

Peter
EDIT:PRESS MENU

**3** Press **MENU**.

Example: 

NAME=Peter
EDIT=* DELETE=#

**4** Press **#** to select "DELETE".

DELETE OK?  
YES:SET/NO:STOP

- To cancel erasing, press **STOP**.

**5** Press **SET**.

DELETED

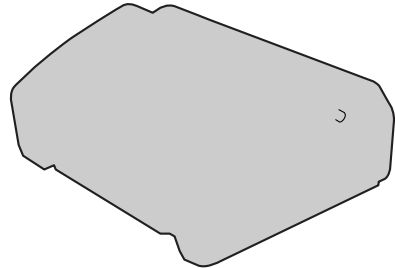

- The stored name and number are deleted.

Before using this feature, program the desired names and telephone numbers into one-touch dial and navigator directory (p. 20, 21).



**1** Press .

Display:

**2** Press  or  until the desired item is displayed.

Example:

- If the desired name has not been stored, press **STOP** and dial the number manually.

**3** Press **MONITOR** or lift the handset.

- The unit will start dialing automatically.

**Note:**

- When you want to search for symbols (not letters or numbers), press  in step 3.

## Caller ID service from your phone company

This unit is compatible with the Caller ID service offered by your local telephone company. To use this feature, you must subscribe to the Caller ID service.

Change the following ring settings to 2 or more rings beforehand.

- FAX ring setting (feature #06 on page 50)
- TEL/FAX ring setting (feature #78 on page 55)

### How Caller ID is displayed

The calling party's name or telephone number will be displayed after the first ring. You then have the option of whether or not to answer the call depending on the caller.

Example: 

Chris Horner 1-654-987-3210
--------------------------------

The unit will automatically store the caller information (name, telephone number and the time of the call). You can view the caller information (see the next page) and print the caller ID list (p. 69).

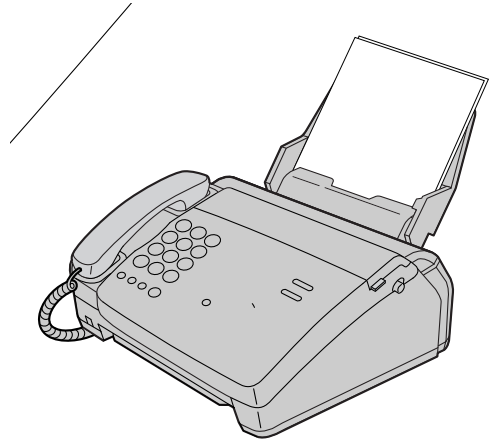

#### Note:

- If the unit is connected to a PBX (Private Branch Exchange) system, you may not receive the caller information. Consult your PBX supplier.
- If the unit cannot receive caller information, the unit will show the following.

OUT OF AREA
-------------

The caller dialed from an area which does not provide Caller ID service.

PRIVATE CALLER
----------------

The caller requested not to send caller information.

LONG DISTANCE
---------------

The caller made a long distance call.



**1** Press **CALLER ID**.

**Example** (2 new calls are received):

Example: 

2 NEW CALLS PRESS NAVI. [+ -]
----------------------------------

**2** Press **+** or **-** to view caller information.

- If you press **+**, the display will show the most recent caller's name.
- If you press **-**, the display will show the already viewed calls.

**3** Press **MONITOR** or lift the handset to make a call.

- The unit will start dialing automatically.
- To send a fax – insert the document **FACE DOWN** and press **FAX START**.

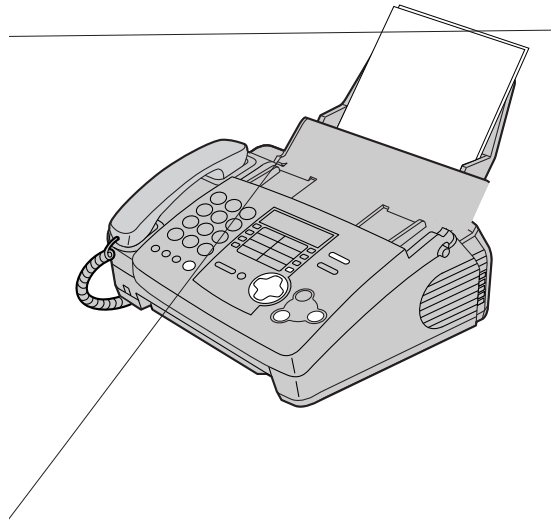

## To display the caller's telephone number

Press **NAME/TEL NO.** after step 2.

Example: 

WENDY ROBERTS 11:20A Jul20	1-345-678-9012 11:20A Jul20
-------------------------------	--------------------------------

# Caller ID

## Confirming caller information using the Caller ID list

The unit will store the 30 most recent caller information.

— To print manually, see page 69.

— To print automatically after every 30 new calls, activate feature #26 (p. 52).

### Sample of a Caller ID list

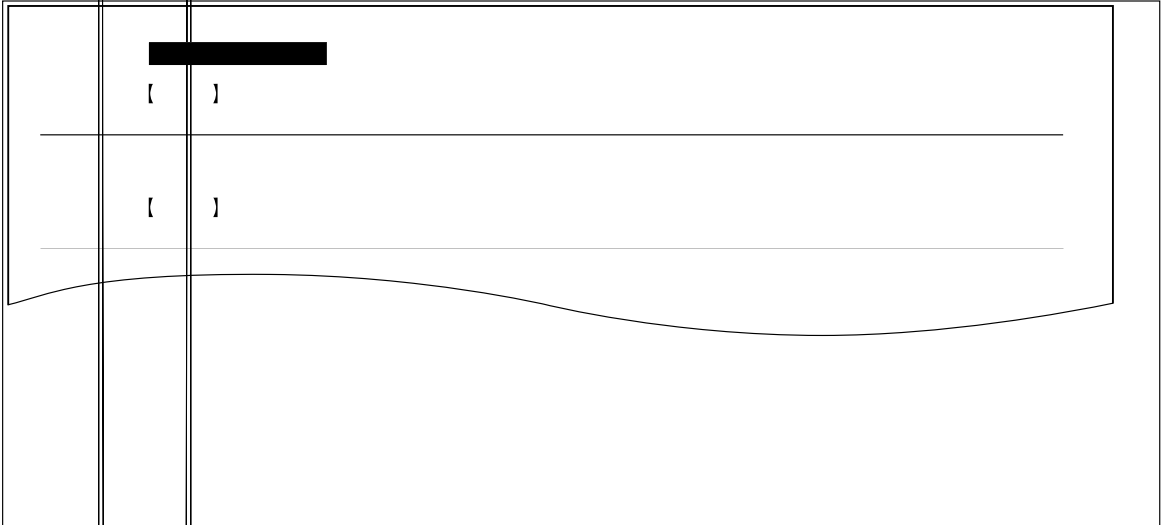

### Erasing the Caller ID list

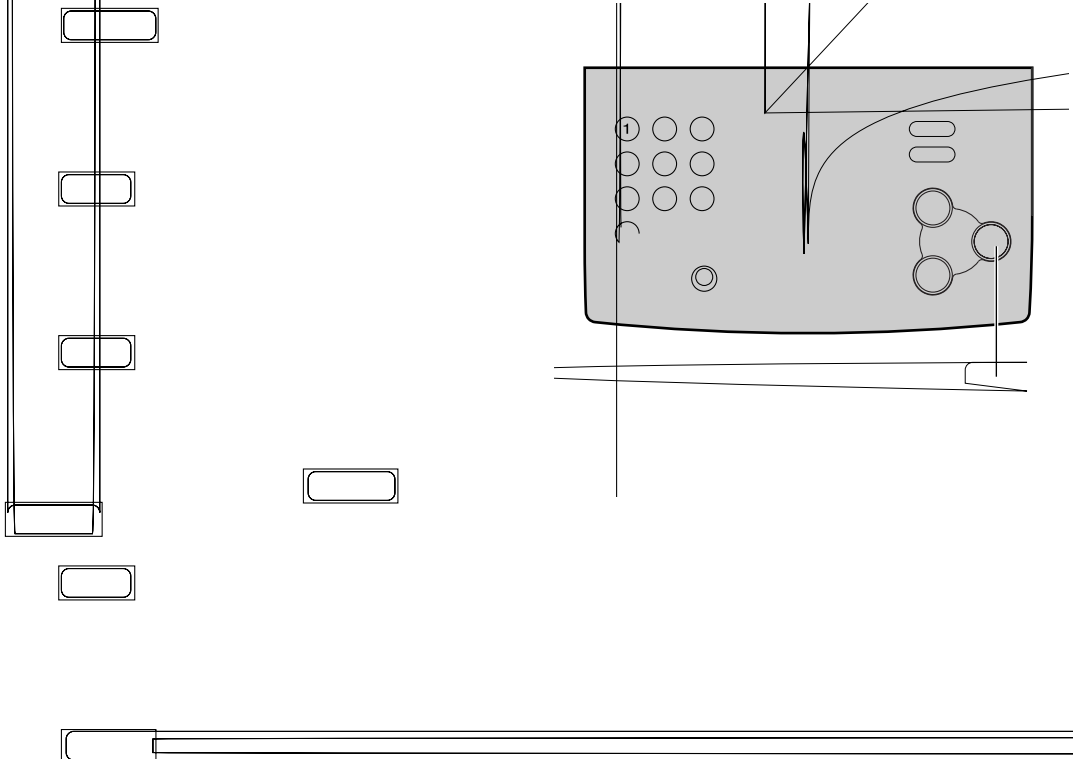

## Storing caller information in one-touch dial and navigator directory

### Important:

- This feature is not available in the following cases.
  - The telephone number includes data other than numbers (i.e. \* or #).
  - The caller information does not include a telephone number.

**1** Press **CALLER ID**.

Example: 

2 NEW CALLS PRESS NAVI. [+ -]
----------------------------------

**2** Press **+** or **-** until the name you want to store is displayed.

Example: 

WENDY 11:50A Apr14
-----------------------

**3** Press **MENU**.

WENDY PRESS STATION OR
↑
WENDY PRESS NAVI.

**4** For station 1:  
Press station 1 key.

STATION 1 DIAL MODE [±]
----------------------------

Press **SET**.

Example: 

NAME=WENDY STORE:PRESS SET
-------------------------------

Press **SET**.

Example: 

<S01>1345678901
-----------------

For stations 2–7:  
Press the desired station key.

Example: 

NAME=WENDY STORE:PRESS SET
-------------------------------

Press **SET**.

Example: 

<S04>1345678901
-----------------

For stations 8–14:  
Press **LOWER**, then press the desired station key.

Example: 

NAME=WENDY STORE:PRESS SET
-------------------------------

Press **SET**.

Example: 

<S09>1345678901
-----------------

### For navigator directory:

Press **▶**.

Example: 

NAME=WENDY STORE:PRESS SET
-------------------------------

Press **SET**.

Example: 

NO.=1345678901
----------------

**5** Press **SET**.

REGISTERED
------------

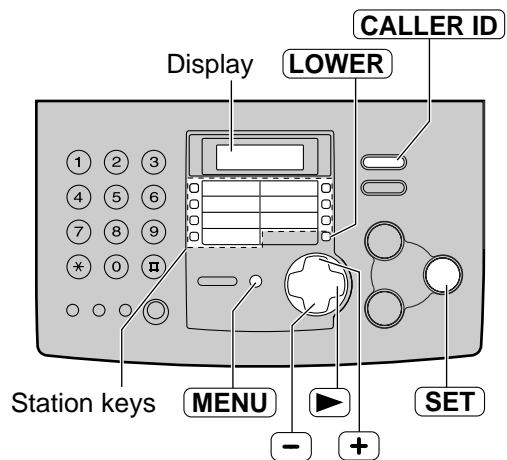

### Note:

- You can confirm the stored items on the telephone number list (p. 69).
- You can only store a name of up to 10 characters long.
- To edit a name and number, see page 22.
- If you enter a new item into a station key, the previous entry will be overwritten.
- If you use station 1 as a broadcast key, you cannot store caller information for station 1.
- If the navigator directory is full, you cannot store caller information.

# Voice Contact

---

- 1 Press **MONITOR** while transmitting or receiving documents.

Example: 

SENDING P 1
VOICE STANDBY

- Your unit will call the other party with a distinctive ring.
- When the other party answers, your unit will emit a distinctive ring.

- 2 Lift the handset to start talking.

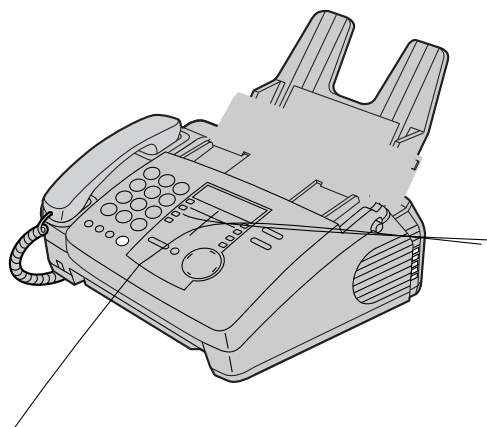

## Sending a fax manually

- 1 Open the document feeder tray.
- 2 Adjust the width of the document guides to the size of the document.
- 3 Insert the document (up to 15 pages) **FACE DOWN** until a single beep is heard and the unit grabs the document.

Display: 

STANDARD PRESS NAVI. [+ -]
-------------------------------

- 4 If necessary, press **+** or **-** repeatedly to select the desired resolution (see below).

- 5 Press **MONITOR** or lift the handset.

TEL= PRESS STATION OR
--------------------------

  
↑  

TEL= PRESS NAVI. [▶]
-------------------------

- 6 Dial the fax number.

Example: 

TEL=5678901
-------------

- 7 **When a fax tone is heard:**

Press **FAX START**, and replace the handset if you are using it.  
OR

**When the other party answers your call:**

Using the handset, ask them to press their start button. When the fax tone is heard, press **FAX START** and replace the handset.

CONNECTING . . . . . STANDARD [±]
--------------------------------------

### To redial the last number

Press **REDIAL/PAUSE**.

- If the line is busy, the unit will automatically redial the number up to 2 times.
- During redial, the following will be displayed.

Display: 

WAITING REDIAL
----------------

- To cancel redialing, press **STOP**.

### Convenient way to send a fax

You can dial the fax number first before inserting the document. This is convenient if the other party's number is indicated on the document.

1. Enter the fax number.
  - The handset must be on the cradle.
2. Insert the document.
3. Press **FAX START**.

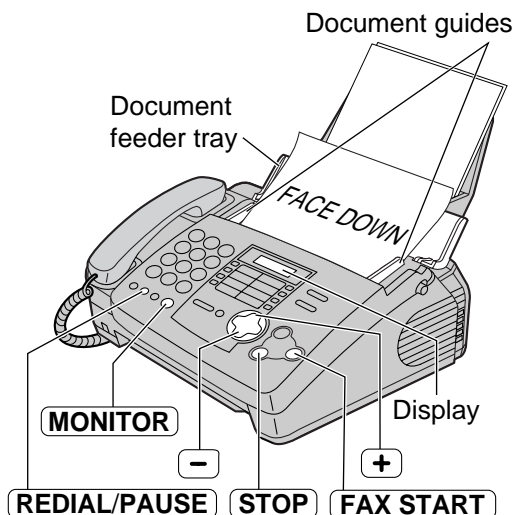

### To select the resolution

Select the desired resolution according to the type of document.

- **STANDARD:** For printed or typewritten originals with normal-sized characters.
- **FINE:** For originals with small printing.
- **SUPER FINE:** For originals with very small printing. This setting only works with other compatible fax machines.
- **PHOTO:** For originals containing photographs, shaded drawings, etc.
- Using the "FINE", "SUPER FINE", or "PHOTO" setting will increase transmission time.
- If the resolution setting is changed during feeding, it will be effective from the next sheet.

### Quick scan feature

With this feature, the unit will scan the document into memory before sending. This is helpful when you want to remove the document for other uses. To activate this feature, see feature #34 on page 53. After storing, the unit will transmit the document.

- If the document exceeds the memory capacity (p. 73), sending will be canceled and this feature will be turned off automatically. Transmit the entire document manually.

### To stop transmission

Press **STOP**.

# Sending Faxes

## Reports for confirmation

### Sending report

This report will provide you with a printed record of transmission results. For the communication message in the result column, see page 56. To use this feature, activate feature #04 (p. 50).

### Journal report

The unit stores the 30 most recent fax communication results. For the communication message in the result column, see page 56. When a new communication occurs, the oldest communication result will be erased.

— To print manually, see page 69.

— To print automatically after every 30 new fax communications, activate feature #22 (p. 52).

## Documents you can send

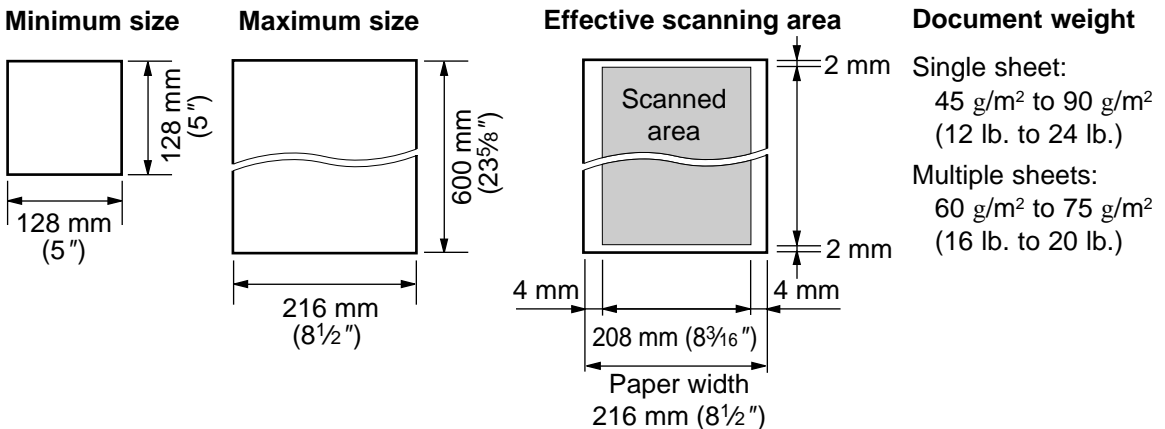

### Note:

- Remove clips, staples or other similar fasteners.
- Check that ink, paste or correction fluid has dried.
- Do not send the following types of documents. Use copies for fax transmission.
  - Chemically treated paper such as carbon or carbonless duplicating paper
  - Paper with printing on the opposite side that can be seen through the front (e.g. newspaper)
  - Electrostatically charged paper
  - Badly curled, creased or torn paper
  - Paper with a coated surface
  - Paper with a faint image
- To transmit the document(s) whose width is less than the letter size (216 mm) or A4 size (210 mm), we recommend using a copier machine. Copy the original document on to a letter size paper, then transmit the copied document.

### To transmit more than 15 pages at a time

- Insert the first 15 pages of the document. Add the other pages (15 at a time) before the last page is fed into the unit.

## Sending a fax using one-touch dial and navigator directory

Before using this feature, program the desired names and telephone numbers into one-touch dial and navigator directory (p. 20, 21).

- 1 Open the document feeder tray.
- 2 Adjust the width of the document guides to the size of the document.
- 3 Insert the document (up to 15 pages) **FACE DOWN** until a single beep is heard and the unit grabs the document.

Display: 

STANDARD PRESS NAVI. [+ -]
-------------------------------

- 4 If necessary, press **+** or **-** repeatedly to select the desired resolution (p. 29).
- 5 Enter the fax number.  
**Using stations 1–7:**  
Press the desired station key.

### Using stations 8–14:

Press **LOWER**, then press the desired station key.

### Using navigator directory:

Press **▶**, then press **+** or **-** to display the desired item and **FAX START**.

- For further details about using the directory, see page 23.

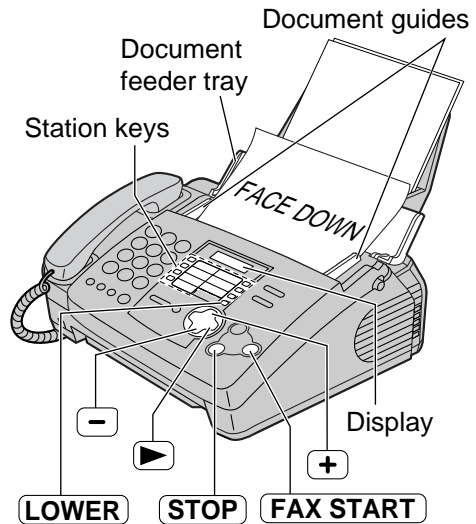

### Fax auto redial

If the line is busy or if there is no answer, the unit will automatically redial the number up to 2 times.

- This feature is also available for delayed transmission (feature #25 on page 52).
- During redial, the following will be displayed.

Display: 

WAITING REDIAL
----------------

- To cancel redialing, press **STOP**.

### If your unit does not send a fax

- Confirm the stored telephone number on the display and check that the number dialed is answered by the other party's machine (p. 23).
- The connecting tone will be heard during dialing to tell you the status of the other party's machine (feature #76 on page 55).

# Sending Faxes

## One time broadcast transmission

This feature is useful for sending the same document to selected parties only once. Select the parties using one-touch dial or navigator directory for each transmission.

- 1 Insert the document FACE DOWN.
  - If necessary, press **[+]** or **[-]** repeatedly to select the desired resolution (p. 29).

- 2 Press **[▶]**.

Display: 

DIRECTORY[+ -]
----------------

- 3 Press **[+]** or **[-]** until the following is displayed.

<ONE TIME BROAD> PRESS SET
-------------------------------

- 4 Press **[SET]** to start programming the items you want to transmit.

DIR=	[00]
NAVI.[+ -] & SET	

- 5 Enter items.

### Using stations 2–7:

Press the desired station key.

Example: 

DIR=ANN	[01]
SEND:PRESS SET	

### Using stations 8–14:

Press **[LOWER]**, then press the desired station key.

### Using navigator directory:

Press **[+]** or **[-]** until the desired item is displayed and press **[SET]**.

- To program other items, repeat this step (up to 20 items).

- 6 Press **[SET]** to start transmission to the programmed items.

- The document will be fed into the unit and scanned into memory. The unit will then transmit the data to each item, calling each number sequentially.
- After transmission, the stored document will be erased automatically, and the unit will automatically print a broadcast sending report.

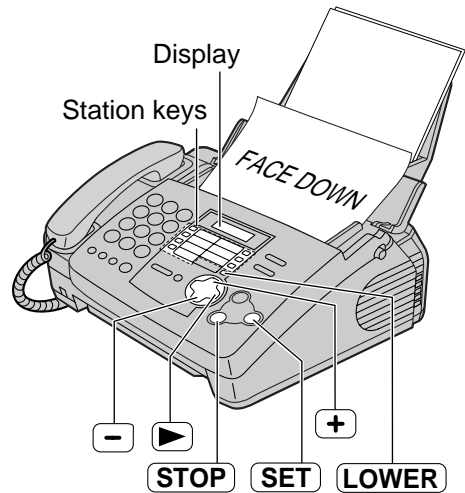

### Note:

- If you select the “FINE”, “SUPER FINE” or “PHOTO” resolution, the number of pages that the unit can transmit will decrease.
- If the document exceeds the memory capacity (p. 73), sending will be canceled.
- If one of the items is busy or does not answer, the item will be skipped. All skipped items will be redialed up to 2 times after all of the other items have been called.

### To cancel the broadcast setting

1. Press **[STOP]** while the unit displays the following.

Display: 

BROADCASTING
--------------

- The display will show the following.

SEND CANCELED? YES:SET/NO:STOP
-----------------------------------

2. Press **[SET]**.



## Broadcast transmission to pre-programmed parties

This feature is useful for sending the same document often to selected parties (up to 20 items). First program the items, then see page 35 for transmission.

- The broadcast function utilizes station 1. The one-touch dial function will be canceled.
- BROADCAST key 1 can accept one-touch dial and Navigator entries.

### Programming the items in the broadcast memory

**1** Press **MENU** two times.

Display: 

DIRECTORY SET PRESS STATION OR
-----------------------------------

  
↓  

DIRECTORY SET PRESS NAVI.
------------------------------

**2** Press **BROADCAST**.

STATION 1 DIAL MODE [±]
----------------------------

**3** Press **+** or **-** to select "BROADCAST".

STATION 1 BROADCAST [±]
----------------------------

**4** Press **SET**.

DIR= [00] NAVI. [+ -] & SET
--------------------------------

**5** Enter items.  
**Using stations 2-7:**  
Press the desired station key.

Example: 

DIR=Luke [01] STORE:PRESS SET
----------------------------------

#### Using stations 8-14:

Press **LOWER**, then press the desired station key.

#### Using navigator directory:

Press **+** or **-** until the desired item is displayed and press **SET**.

- To program other items, repeat this step (up to 20 items).

**6** Press **SET** after programming all of the desired items.

REGISTERED
------------

**7** Press **STOP** to exit the program.

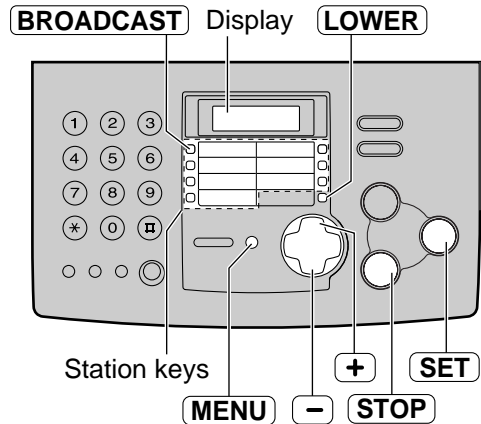

#### Note:

- If you enter the wrong item, press **STOP** after step 5 to erase the item.
- Confirm the stored items by printing a broadcast programming list (p. 69).

# Sending Faxes

## Adding a new item in the broadcast memory

- 1** Press **[▶]**.  
● Confirm that there are no documents in the document entrance.

Display: 

DIRECTORY[+ -]
----------------

- 2** Press **[+]** or **[-]** until the following is displayed.

<BROADCAST> EDIT:PRESS MENU
--------------------------------

- 3** Press **[MENU]**.

BROADCAST ADD=* DELETE=#
-----------------------------

- 4** Press **[\*]** to select "ADD".

- 5** Press **[+]** or **[-]** until the desired item you want to add is displayed (only available when using navigator directory).

Example (Navigator): 

Mary 1-584-372-4123
------------------------

Example (Station 2): 

Peter <S02> 1-926-553-2168
-------------------------------

- 6** Press **[SET]**.

REGISTERED
------------

Example: 

Tracy 1-385-217-9365
-------------------------

- To add other items, repeat steps 5 and 6 (up to 20 items).

- 7** Press **[STOP]** to exit the program.

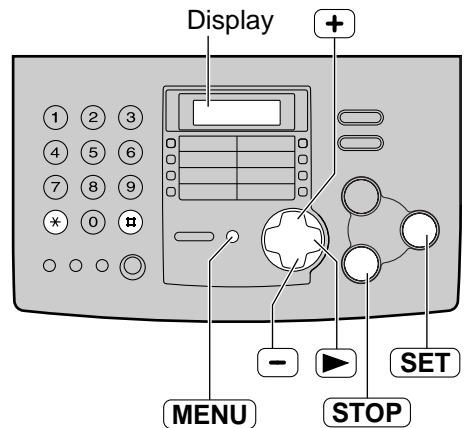

## Erasing a stored item in the broadcast memory

- 1** Press **[▶]**.  
● Confirm that there are no documents in the document entrance.

Display: 

DIRECTORY[+ -]
----------------

- 2** Press **[+]** or **[-]** until the following is displayed.

<BROADCAST> EDIT:PRESS MENU
--------------------------------

- 3** Press **[MENU]**.

BROADCAST ADD=* DELETE=#
-----------------------------

- 4** Press **[#]** to select "DELETE".

- 5** Press **[+]** or **[-]** until the desired item you want to erase is displayed (only available when using navigator directory).

- To cancel erasing, press **[STOP]**.

- 6** Press **[SET]**.

DELETE OK? YES:SET/NO:STOP
-------------------------------

- 7** Press **[SET]**.

DELETED
---------

Example: 

Bob 0123456
----------------

- To delete other items, repeat steps 5 to 7.

- 8** Press **[STOP]** to exit the program.

## Sending the same document to pre-programmed parties

- 1 Insert the document **FACE DOWN**.
  - If necessary, press **+** or **-** repeatedly to select the desired resolution (p. 29).

- 2 Press **BROADCAST**.
  - You can also use **+** / **-** key. Press **▶** then press **+** or **-** until the following is displayed, and press **SET**.

Display: 

<BROADCAST> SEND:PRESS SET
-------------------------------

- The document will be fed into the unit and scanned into memory. The unit will then transmit the data to each item, calling each number sequentially.
- After transmission, the stored document will be erased automatically, and the unit will automatically print a broadcast sending report.

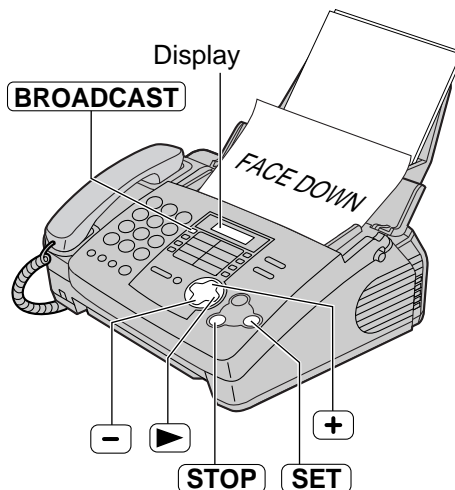

### Note:

- If you select the "FINE", "SUPER FINE" or "PHOTO" resolution, the number of pages that the unit can transmit will decrease.
- If the document exceeds the memory capacity (p. 73), sending will be canceled.
- If one of the items is busy or does not answer, the item will be skipped. All skipped items will be redialed up to 2 times after all of the other items have been called.

### To cancel the broadcast setting

1. Press **STOP** while the unit displays the following.

Display: 

BROADCASTING
--------------

- The display will show the following.

SEND CANCELED? YES:SET/NO:STOP
-----------------------------------

2. Press **SET**.

# Receiving Faxes

## Setting the unit to receive faxes

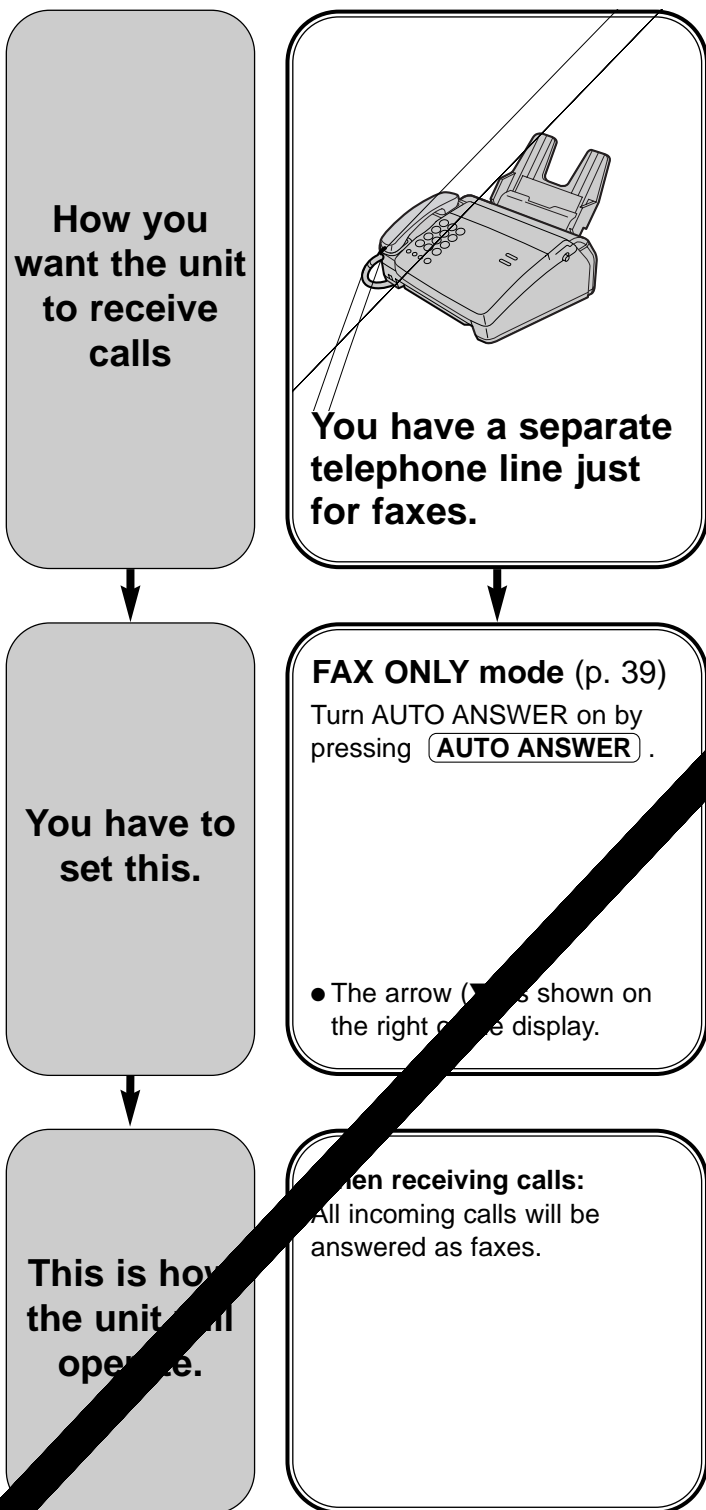

## Voice mail service (Distinctive Ring)

2-number example

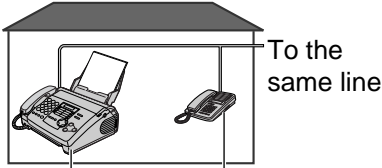

Facsimile No. (555-1333) Telephone No. (555-1111)

**You need to subscribe to Distinctive Ring Service.**

## Mostly phone calls

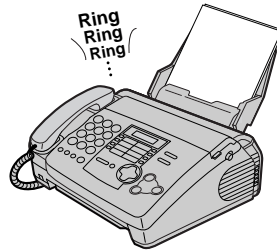

**You plan to answer the calls yourself.**

## Other options

### TEL/FAX mode

If you are near the unit and want to use it to receive phone calls yourself and faxes automatically, see pages 40 and 41.

### Remote fax activation

You can also receive a fax using an extension telephone. While hearing a fax calling tone with an extension telephone, press **\* 9** (pre-selected fax activation code) to receive a fax (p. 43).

### Setting the Distinctive Ring pattern (p. 45)

Select the same ring pattern assigned to the facsimile number. (Default setting is B.)

- A: Standard ring (one long ring)
- B: Double ring (two short rings)**
- C: Triple ring (short-long-short rings)
- D: Other triple ring (short-short-long rings)

### TEL mode (p. 38)

Turn AUTO ANSWER off by pressing **AUTO ANSWER**.

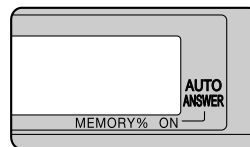

- The arrow (▼) is not shown on the right of the display.

**When the fax machine detects a call matching the selected Distinctive Ring pattern:** The fax machine will activate the fax function.

**When the fax machine detects other ring patterns:** The fax machine will operate based on the AUTO ANSWER setting.

### When receiving calls:

You have to answer all calls manually.

To receive a fax document, press **FAX START** for each fax receiving.

# Receiving Faxes

## TEL mode --- --- (answering all calls manually)

### Activating TEL mode

If the arrow (▼) is shown on the right of the display, turn it off by pressing **AUTO ANSWER**.

Display: TEL MODE  
ON

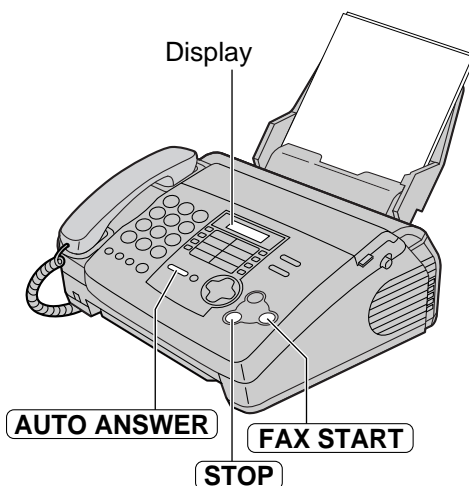

### Receiving a fax manually

- 1 When the unit rings, lift the handset to answer the call.
- 2 When:
  - document reception is required,
  - a fax calling tone (slow beep) is heard, or
  - no sound is heard,press **FAX START**.

CONNECTING.....

- 3 Replace the handset.
  - The unit will start fax reception.

#### Note:

- If you do not answer the call within 10 rings, the unit will temporarily switch to the fax and the caller can send a document.

#### To stop receiving

Press **STOP**.

#### Friendly reception feature

When you answer a call and hear a fax calling tone (slow beep), the unit will automatically start fax reception.

- If this feature is not required, set feature #46 to off (p. 54).

#### Fax reception in memory

When a printing problem is detected, the unit will temporarily store the received document into memory.

While the document is in memory:

- the display will show an error message and the following alternately,

Display: FAX IN MEMORY

- slow beeps will sound if feature #44 is set to on (p. 54).

- Follow the instructions on pages 57 and 58 to solve the problem.
- For memory capacity, see page 73.

# Receiving Faxes

---

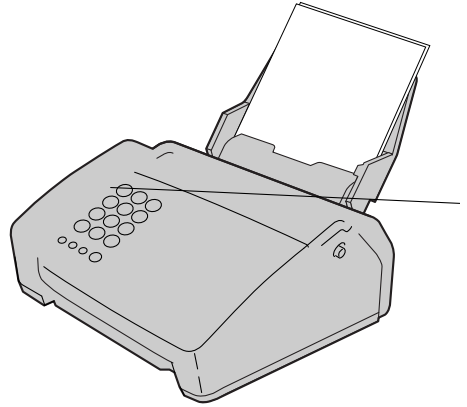

# Receiving Faxes

## TEL/FAX mode (receiving phone calls with ring signals and faxes without ring signals when you are near the unit)

Use this mode when you are always near the fax machine, and want to receive faxes without the unit ringing. When a call is received, the fax machine will work as follows. To set TEL/FAX mode, see below.

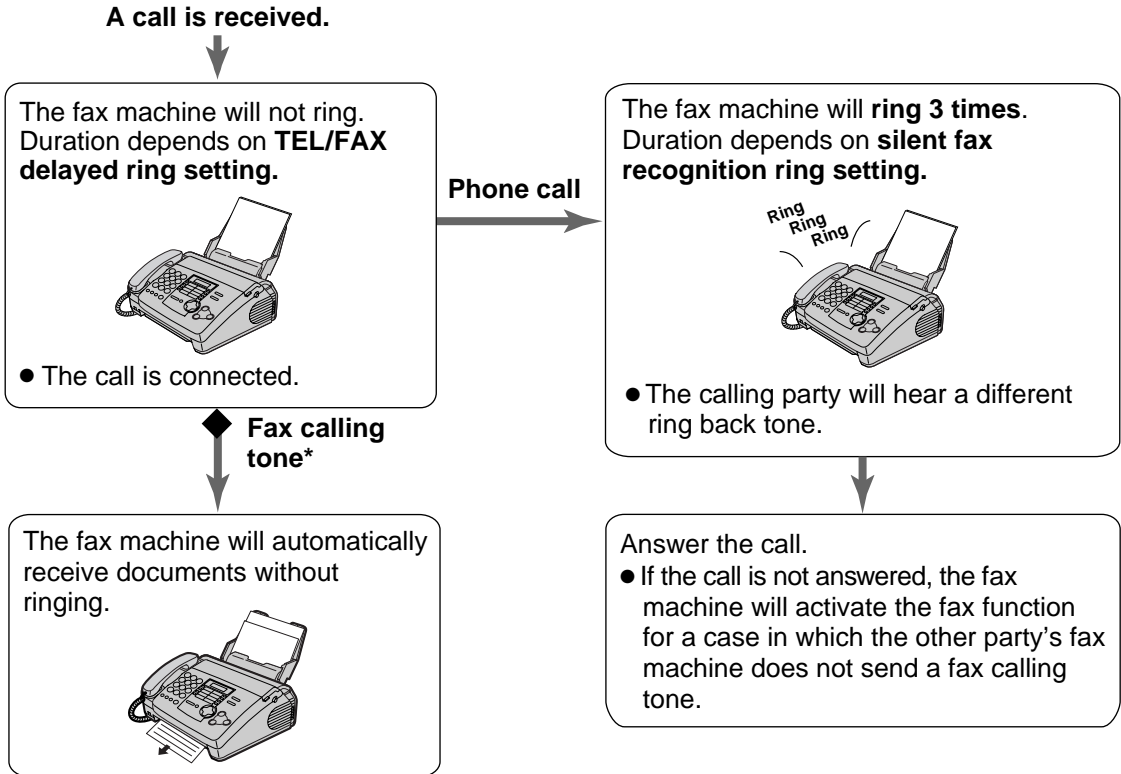

### Note:

- The fax machine will display the following when a call is received.

Display:

- The ringer should be on (p. 19).
- If the ring detection (p. 45) is set and a different ring pattern is received, the unit will not receive the fax automatically.

\* A fax calling tone is automatically generated by the sending fax machine. Some fax machines do not have this capability.

### To set TEL/FAX mode

1. Set feature #77 to "TEL/FAX" (p. 55).
2. If the arrow (▼) is not shown on the right of the display, turn it on by pressing **AUTO ANSWER**.

Display:  ▼  
ON



## When an extension telephone is connected

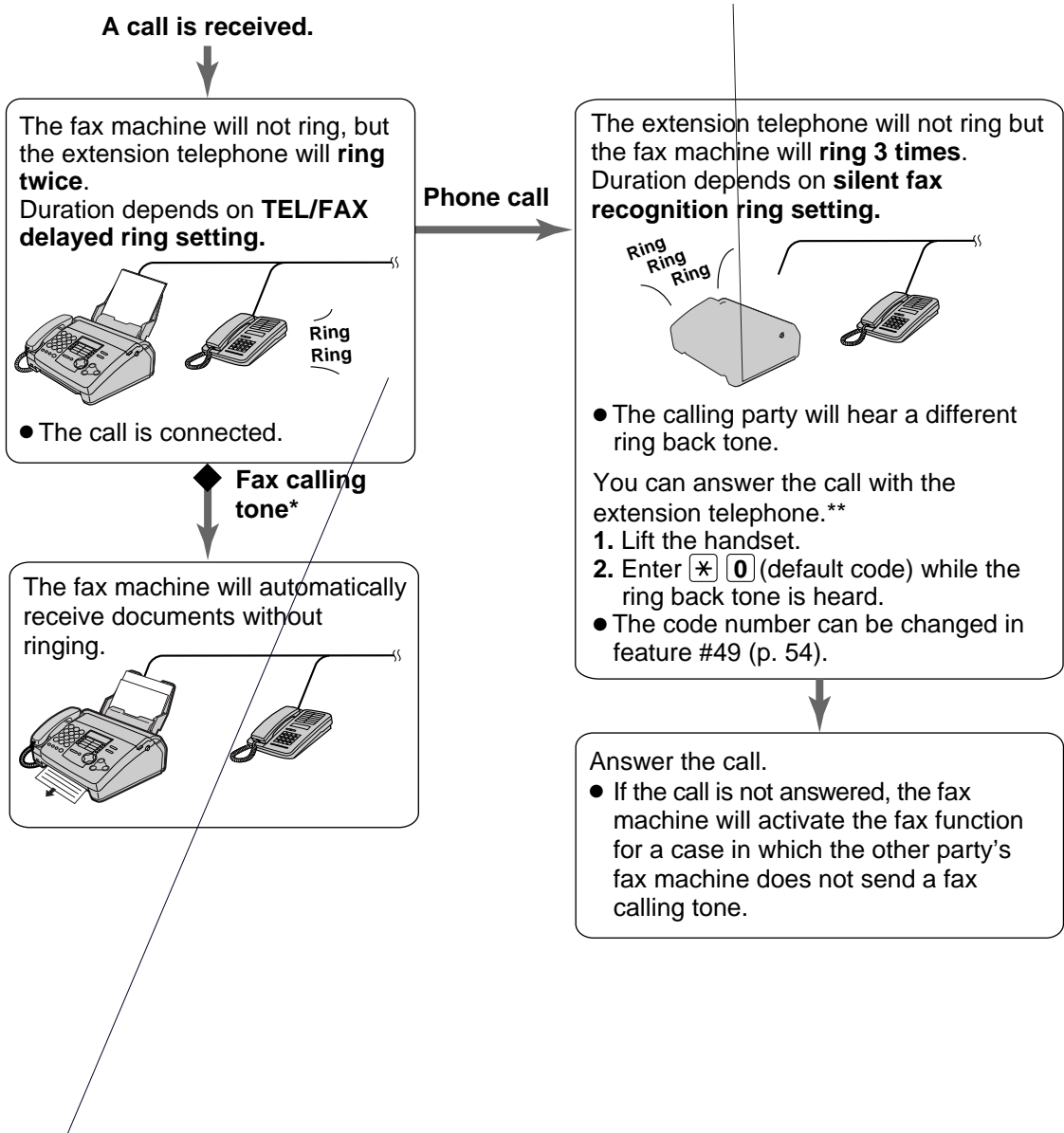

### TEL/FAX delayed ring setting

The number of rings generated before the fax machine answers depends on the setting of feature #78 on page 55. The fax machine will not generate an audible ring during this time.

### Silent fax recognition ring setting

The fax machine generates audible rings to indicate that it is receiving a phone call. The number of rings generated depends on the setting of feature #30 on page 53. This signal will not ring at an extension telephone.

# Receiving Faxes

---

## Using the unit with an answering machine

### Setting up the fax machine and an answering machine

- 1 Connect the answering machine.



Telephone line cord (not included)

- 2 Set the number of rings on the answering machine to less than 4.
  - This will allow the answering machine to answer the call first.
- 3 Record a greeting message on the answering machine.

**Example:** *"This is (your name, business and/or telephone number). We are unable to answer the phone right now. To send a fax, start transmission. To leave a message, please speak after the beep. Thank you."*

  - We recommend you record your message around 10 seconds long and not to pause for more than 4 seconds during the message. Otherwise, both machines will not function correctly.
- 4 Activate the answering machine.
- 5 Set the receive mode of the fax machine to TEL mode (p. 38) or FAX ONLY mode (p. 39).
  - If you set to FAX ONLY mode, **change the ring setting in FAX ONLY mode to "5 EXT.TAM" (feature #06 on page 50)**. Using FAX ONLY mode will allow you to receive faxes if the answering machine is full.
- 6 Check the remote access code of the answering machine and program the same code into the remote operation ID of the fax machine. See feature #12 on page 51.

## How the fax machine and answering machine work

### Receiving phone calls

The answering machine will record voice messages automatically.

### Receiving faxes

The fax machine will receive documents automatically when the machine detects a fax calling tone.

### Receiving a voice message and fax document in one call

The answering machine will record the voice message first. The fax machine will then be activated by the caller's request and will receive the document.

### Note:

- Every time the fax machine receives a document, a silent pause or fax tone may be recorded on the answering machine.

## Receiving a voice message and fax document in one call

The caller can leave a voice message and send a fax document during the same call. Inform the caller of the following procedure beforehand.

1. The caller calls your fax machine.
  - The answering machine will answer the call.
2. The caller can leave a message after the greeting message.
3. The caller presses **\*9** (pre-selected fax activation code).
  - The fax machine will activate the fax function.
4. The caller presses the start button to send a document.

### Note:

- The fax activation code can be changed in feature #41 (p. 54).
- If the wrong fax activation code is entered, the caller must wait at least 5 seconds to reenter the correct code.

## Extension telephone

If you use the fax machine with an extension telephone, you can receive fax documents using the extension telephone. You do not have to press **FAX START** on the fax machine.

### Important:

- Use a touch tone telephone as the extension telephone and enter the fax activation code **firmly**.

**1** When the extension telephone rings, lift the handset of the extension telephone.

**2** When:  
— document reception is required,  
— a fax calling tone (slow beep) is heard, or  
— no sound is heard,  
press **\*9** (pre-selected fax activation code) **firmly**.

**3** Hang up the handset.

- The fax machine will start reception.

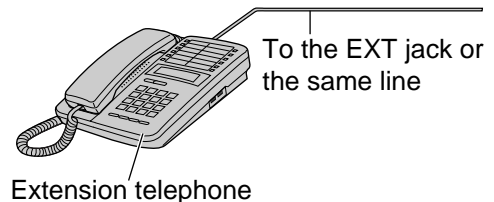

### Note:

- You can change the fax activation code in feature #41 (p. 54).

# Receiving Faxes

## Pager call - when the unit receives a fax

This feature allows your unit to call your pager when your unit receives a fax document.

**1** Press **MENU**.  
Display: SYSTEM SET UP  
PRESS NAVI. [◀ ▶]

**2** Press **▣**, then **7 0**.  
FAX PAGER CALL  
MODE=OFF [±]

**3** Press **+** or **-** to select "ON".  
FAX PAGER CALL  
MODE=ON [±]

- If this feature is not required, select "OFF".

**4** Press **SET**.  
NO. =

**5** Enter your pager number up to 30 digits.  
Example: NO. = 12025551234

**6** Press **SET**.  
PIN =

**7** Enter your pager access code up to 10 digits if required.  
Example: PIN = 12345678

**8** Press **SET**.  
MSG. = 07734

- The default code 07734 will show "Hello!" on your pager.
- If you want to change this message, enter your message up to 30 digits.

Example: MSG. = 5555

**9** Press **SET**.  
• The unit will dial the stored number.

PAGER TEST

**10** Check that your pager received the pager test call.

**11** Press **MONITOR**.

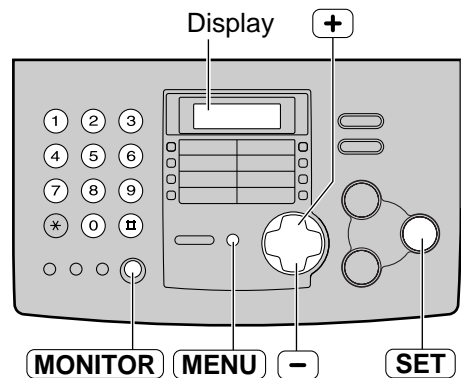

### Note:

- If you have subscribed to a Caller ID service, your pager will display the caller's telephone number instead of the message.

### When your pager receives a pager call

Your pager will display the message you entered in step 8. (For example: 5555)

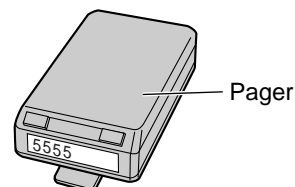

## Important:

- When you have a single telephone line and subscribe to a telephone company's voice mail service, you must also subscribe to the Distinctive Ring Service if you want to receive faxes automatically as well as voice messages. For more information about telephone services, contact your telephone company.

When you subscribe to Distinctive Ring Service, your telephone company will assign you a new fax number and will also tell you the assigned ring pattern. Please complete the following setup on your fax machine to identify the assigned ring pattern.

**1** Press **MENU** .

Display: 

SYSTEM SET UP PRESS NAVI. [◀ ▶]
------------------------------------

**2** Press **Ⓜ** , then **3 1** .

RING DETECTION MODE=B [±]
------------------------------

**3** Press **+** or **-** to select the ring pattern assigned by the telephone company.

- A:** Standard ring (one long ring)
- B:** Double ring (two short rings) (default setting)
- C:** Triple ring (short-long-short-rings)
- D:** Other triple ring (short-short-long rings)
- OFF:** Turns off the feature

**4** Press **SET** .

SETUP ITEM [ ]
----------------

**5** Press **MENU** to exit the program.

# Copying

## Making a copy

The unit can make single or multiple copies (up to 99).

- 1 Open the document feeder tray.
- 2 Adjust the width of the document guides to the size of the document.
- 3 Insert the document (up to 15 pages) **FACE DOWN** until a single beep is heard and the unit grabs the document.

Display: 

STANDARD PRESS NAVI. [+ -]
-------------------------------

- If necessary, press **+** or **-** repeatedly to select the desired resolution (see below).
- Make sure the handset is on the cradle.

- 4 Press **COPY START**.

NUMBER=1 COPY:PRESS START
------------------------------



NUMBER=1 OR PRESS NAVI. ▶
------------------------------

- If necessary, enter the number of copies (up to 99).

- 5 Press **COPY START**.

  - The unit will start copying.

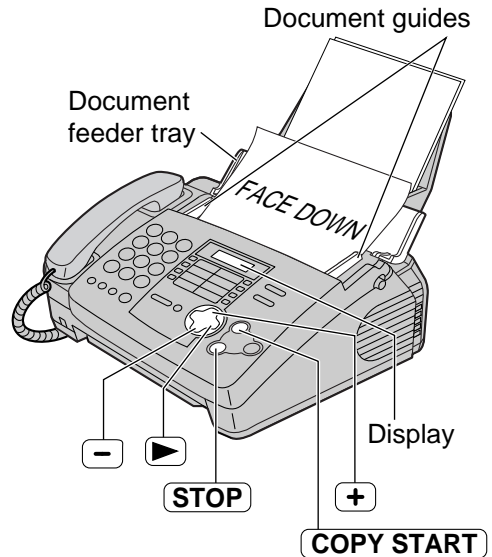

### Note:

- Any transmittable document can be copied (p. 30).

### To select the resolution

Select the desired resolution according to the type of document.

- **FINE**: For printed or typewritten originals with small printing.
- **SUPER FINE**: For originals with very small printing.
- **PHOTO**: For originals containing photographs.
- If you select "STANDARD", copying will be done using "FINE" mode.

### To stop copying

Press **STOP**.

## Convenient way to make a copy

### To enlarge a document

1. Press in step 4 on page 46.

Display: 

ZOOM 100%[+ -] <COLLATE>
-----------------------------

2. Press to select "150%" or "200%".

- The unit will only enlarge the center most part of the document, printing it on two pages.

#### Example of a 150% enlarged copy

Original document      Enlarged copy

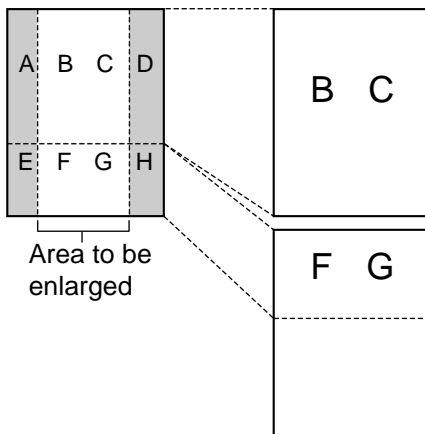

#### Example of a 200% enlarged copy

Original document      Enlarged copy

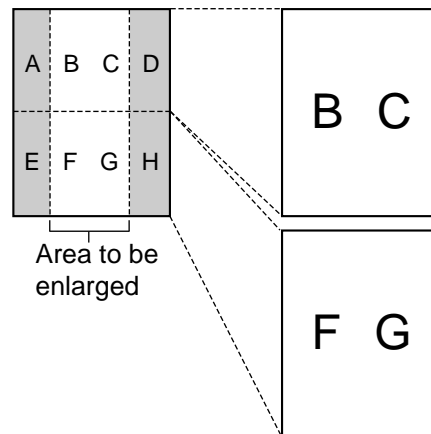

### To reduce a document

1. Press in step 4 on page 46.

Display: 

ZOOM 100%[+ -] <COLLATE>
-----------------------------

2. Press to select "92%", "86%" or "72%".

- See below for the recommended reduction rates.

Setting	Size of recording paper	Size of original document
100% (default)	Letter	Letter
	Legal	Letter, A4, Legal
	A4	A4, Letter
92%	Letter	A4
86%	Letter	A4
72%	Letter	Legal
	A4	Legal

Letter = 216 mm x 279 mm  
(8<sup>1</sup>/<sub>2</sub>" x 11")  
 Legal = 216 mm x 356 mm  
(8<sup>1</sup>/<sub>2</sub>" x 14")  
 A4 = 210 mm x 297 mm  
(8<sup>1</sup>/<sub>4</sub>" x 11<sup>11</sup>/<sub>16</sub>" )

#### Note:

- If the appropriate reduction rate is not programmed, the document may be divided and the top of the second sheet will be deleted.
- If the image at the bottom of the document is not copied when you copy a document as long as the recording paper, try 92% or 86%.

# Copying

## To collate multiple copies

The unit can collate multiple copies in the same order as the original document pages.

1. Press  2 times in step 4 on page 46.

Display: 

COLLATE OFF [+ -]
<RESOLUTION>▶

2. Press  or  repeatedly until the following is displayed.

COLLATE ON [+ -]
<RESOLUTION>▶

**Example:** Making 2 copies of a 4-page original document

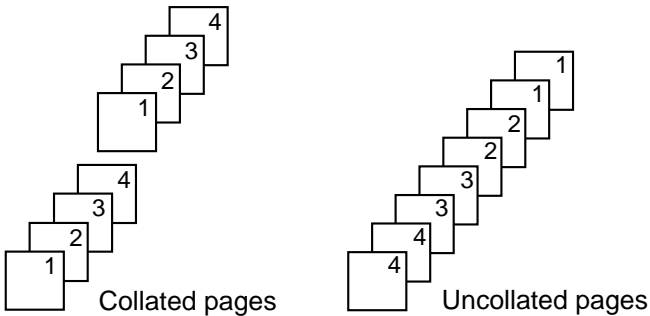

### Note:

- The unit will store the documents into memory while collating the copies. If memory becomes full while storing, the unit will only print out the stored pages.
- After copying, the collating feature will turn off automatically.

## To select the resolution



You can select the resolution according to the type of document after pressing **COPY START** in step 4 on page 46.

- For further details about the resolution, see page 46.

1. Press  3 times in step 4 on page 46.

Display: 

STANDARD [+ -]
<NUMBER>▶

2. Press  or  repeatedly to select the desired resolution.

## Quick scan feature

The unit can scan the document into memory before copying. This feature is helpful when you want to remove the document for other uses.

To activate this feature, see feature #34 on page 53. After storing, the unit will copy the document.

### Note:

- If the document exceeds the memory capacity (p. 73), copying will be canceled and this feature may be turned off automatically.



## Programming

The unit provides various programming features. Program the desired settings by referring to the programming tables (p. 50–55).

### General programming method

**1** Press **MENU**.

Display: 

SYSTEM SET UP
PRESS NAVI. [◀ ▶]

**2** Select the feature you wish to program.

**For basic features** (p. 50, 51):

Press **◀** or **▶** until the desired feature is displayed.

**For advanced features** (p. 52–55):

Press **◀** or **▶** until the following is displayed.

ADVANCED MODE
PRESS SET

Press **SET** and press **◀** or **▶** until the desired feature is displayed.

- The current setting of the feature will be displayed.

**3** Press **+** or **-** until the desired setting is displayed.

- This step may be slightly different depending on the feature.

**4** Press **SET**.

- The setting you selected is set, and the next feature will be displayed.

**5** To exit programming, press **MENU**.

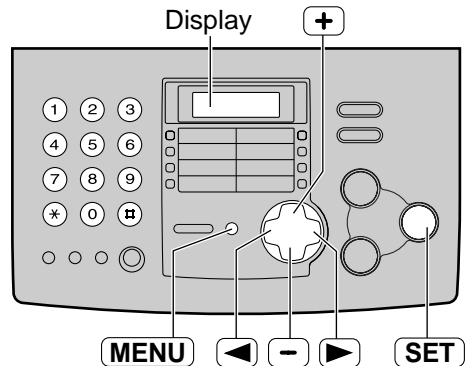

### Programming by entering the program code number directly

You can select a feature by directly entering the program code (# and 2-digit number) instead of using **◀** or **▶** in step 2.

1. Press **MENU**.
2. Press **■** and the 2-digit code number.
3. Follow steps 3 to 5 above.

- See programming tables for code numbers (p. 50–55).

### To cancel programming

Press **MENU** to exit the program.

# Features Summary

## Basic features

### How to set menu options

The following method of programming is applied except features #01, #02 and #03. For features #01, #02 and #03, refer to the programming table below.

1. Press **MENU**.
2. Press **◀** or **▶** until the desired feature is displayed.
3. Press **+** or **-** until the desired setting is displayed.
4. Press **SET**.
5. Press **MENU**.

**Note:**

- Step 3 may be slightly different depending on the feature.
- See page 49 for more details.

### Programming table

Code	Feature & Display	Settings	How the unit operates
#01	<b>Setting the date and time</b> <div style="border: 1px solid black; padding: 2px; width: fit-content;">           SET DATE &amp; TIME            PRESS SET         </div>	mm/dd/yy hh:mm (2 digits for each entry)	See page 15 for details.
#02	<b>Setting your logo</b> <div style="border: 1px solid black; padding: 2px; width: fit-content;">           YOUR LOGO            PRESS SET         </div>	(Up to 30 characters)	See page 16 for details.
#03	<b>Setting your facsimile telephone number</b> <div style="border: 1px solid black; padding: 2px; width: fit-content;">           YOUR FAX NO.            PRESS SET         </div>	(Up to 20 digits)	See page 18 for details.
#04	<b>Printing the sending report</b> <div style="border: 1px solid black; padding: 2px; width: fit-content;">           SENDING REPORT            MODE=ERROR [±]         </div> To print and check the sending report for fax transmission results (p. 30).	<b>ERROR</b>	"ERROR": The sending report will be printed only when fax transmission fails. "ON": The sending report will be printed out after every transmission.
		ON	
		OFF	
#06	<b>Changing the ring setting in FAX ONLY mode</b> <div style="border: 1px solid black; padding: 2px; width: fit-content;">           FAX RING COUNT            RINGS=3 [±]         </div> To change the number of rings before the unit answers a call in FAX ONLY mode.	1, 2, <b>3</b> , 4, 5 EXT.TAM	This setting is also available after activating FAX ONLY mode (p. 39). If you are using the unit with an answering machine, set to "5 EXT.TAM" (p. 42).

(The default setting is in bold type.)

# Features Summary

Code	Feature & Display	Settings	How the unit operates
#12	<b>Securing the remote operation for the answering machine</b> <div style="border: 1px solid black; padding: 2px; width: fit-content;">           REMOTE TAM ACT.            MODE=OFF [ ± ]         </div> <p>If you are using the unit with an answering machine, activate this feature, and set the remote activation ID to secure the remote operation for the answering machine.</p>	ON / ID=11	To select "ON" and enter ID: 1. Press <b>MENU</b> . 2. Press ◀ or ▶ and select this feature. 3. Press <b>+</b> or <b>-</b> to select "ON". 4. Press <b>SET</b> . 5. Enter your ID from 1 to 5 digits, using 0–9,  * and #. 6. Press <b>SET</b> . 7. Press <b>MENU</b> .
		OFF	
#13	<b>Setting the dialing mode</b> <div style="border: 1px solid black; padding: 2px; width: fit-content;">           DIALING MODE            MODE=TONE [ ± ]         </div> <p>If you cannot dial, change the setting depending on your telephone line service.</p>	TONE	"TONE": For tone dial service. "PULSE": For rotary pulse dial service.
		PULSE	
#16	<b>Setting the recording paper size</b> <div style="border: 1px solid black; padding: 2px; width: fit-content;">           PAPER SIZE            =LETTER [ ± ]         </div>	LETTER	"LETTER": Letter or legal size paper = Paper width is 216 mm (8½") "A4": A4 size paper = Paper width is 210 mm (8¼")
		A4	
#17	<b>Setting the ringer pattern</b> <div style="border: 1px solid black; padding: 2px; width: fit-content;">           RINGER PATTERN            MODE=A [ ± ]         </div>	A	You can select the ringer pattern. The selected ringer pattern will sound while setting.
		B	
		C	

(The default setting is in bold type.)

# Features Summary

## Advanced features

### How to set menu options

1. Press **MENU**.
2. Press **◀** or **▶** until the following is displayed.
3. Press **+** or **-** until the desired setting is displayed.
4. Press **SET**.
5. Press **MENU**.

Display: 

ADVANCED MODE PRESS SET
----------------------------

Press **SET** and press **◀** or **▶** until the desired feature is displayed.

#### Note:

- Step 3 may be slightly different depending on the feature.
- See page 49 for more details.

### Programming table

Code	Feature & Display	Settings	How the unit operates	
#22	<b>Setting the journal report to print automatically</b> <table border="1" style="margin-top: 10px;"> <tr> <td style="text-align: center;">AUTO JOURNAL MODE=ON [ ± ]</td> </tr> </table>	AUTO JOURNAL MODE=ON [ ± ]	<b>ON</b>	"ON": The unit will print the journal report automatically after every 30 new fax communications (p. 30).
		AUTO JOURNAL MODE=ON [ ± ]		
OFF				
#23	<b>Sending document overseas</b> <table border="1" style="margin-top: 10px;"> <tr> <td style="text-align: center;">OVERSEAS MODE MODE=ERROR [ ± ]</td> </tr> </table> If you have difficulty sending an overseas fax, activate this feature before starting transmission. This feature makes sending documents easier as the transmission speed is slowed down.	OVERSEAS MODE MODE=ERROR [ ± ]	NEXT FAX	"NEXT FAX": This setting is effective only for the next attempted fax transmission. After transmission, the unit will return to the previous setting. "ERROR": When the previous fax transmission fails and you redial the same number. • This feature is not available for broadcast transmission. • The calling charge may be higher.
		OVERSEAS MODE MODE=ERROR [ ± ]		
		<b>ERROR</b>		
OFF				
#25	<b>Sending a fax at a specified time</b> <table border="1" style="margin-top: 10px;"> <tr> <td style="text-align: center;">DELAYED SEND MODE=OFF [ ± ]</td> </tr> </table> This feature allows you to take advantage of low-cost calling hours offered by your telephone company. • The setting can be reserved to take place up to 24 hours in advance.	DELAYED SEND MODE=OFF [ ± ]	ON / fax no. / hh:mm	To send a document: 1. Insert the document. 2. Follow steps 1 and 2 above. 3. Press <b>+</b> or <b>-</b> to select "ON". 4. Press <b>SET</b> . 5. Enter the fax number. 6. Press <b>SET</b> . 7. Enter the transmission start time. Press <b>*</b> to select "AM" or "PM". 8. Press <b>SET</b> . 9. Press <b>MENU</b> . • To cancel after programming, press <b>STOP</b> then <b>SET</b> .
		DELAYED SEND MODE=OFF [ ± ]		
<b>OFF</b>				
#26	<b>Setting the Caller ID list to print automatically</b> <table border="1" style="margin-top: 10px;"> <tr> <td style="text-align: center;">AUTO CALL. LIST MODE=ON [ ± ]</td> </tr> </table>	AUTO CALL. LIST MODE=ON [ ± ]	<b>ON</b>	"ON": The unit will print the Caller ID list automatically after every 30 new calls (p. 26).
		AUTO CALL. LIST MODE=ON [ ± ]		
OFF				

(The default setting is in bold type.)

# Features Summary

Code	Feature & Display	Settings	How the unit operates																							
#30	<b>Changing the silent fax recognition ring setting</b> <div style="border: 1px solid black; padding: 2px; width: fit-content;">SILENT FAX RING RINGS=3 [ ± ]</div> To change the number of rings when the unit detects a phone call in TEL/FAX mode.	<b>3, 4, 5, 6</b>	See pages 40 and 41 for details.																							
#31	<b>Setting the Distinctive Ring pattern</b> <div style="border: 1px solid black; padding: 2px; width: fit-content;">RING DETECTION MODE=B [ ± ]</div> If you subscribe to a Distinctive Ring Service (Identa-Ring) from your telephone company, activate this feature. This feature is also required for voice mail service.	<b>A, B, C, D</b>	See page 45 for details.																							
		<b>OFF</b>																								
#34	<b>Setting the quick scan</b> <div style="border: 1px solid black; padding: 2px; width: fit-content;">QUICK SCAN MODE=OFF</div> To scan the document into memory before sending/copying. This is helpful when you want to remove the document for other uses.	<b>ON</b>	"ON": The unit will store the documents first and release them. ● If the document exceeds the memory capacity (p. 73), sending/copying will be canceled and this feature may be turned off automatically.																							
		<b>OFF</b>																								
#36	<b>Receiving other sizes of documents</b> <div style="border: 1px solid black; padding: 2px; width: fit-content;">RCV REDUCTION MODE=92% [ ± ]</div> If the size of the document sent by the other party is as large as, or larger than the recording paper, the unit can reduce and print the document. Select the desired reduction rate.	<b>100%</b>	<table border="1" style="width: 100%; border-collapse: collapse;"> <thead> <tr> <th>Setting</th> <th>Recording paper</th> <th>Original document</th> </tr> </thead> <tbody> <tr> <td rowspan="2">100%</td> <td>Legal</td> <td>Letter, A4</td> </tr> <tr> <td>A4</td> <td>Letter</td> </tr> <tr> <td rowspan="2">92%</td> <td>Letter</td> <td>Letter</td> </tr> <tr> <td>Legal</td> <td>Legal</td> </tr> <tr> <td rowspan="2">86%</td> <td>A4</td> <td>A4</td> </tr> <tr> <td>Letter</td> <td>A4</td> </tr> <tr> <td rowspan="2">72%</td> <td>Letter</td> <td>Legal</td> </tr> <tr> <td>A4</td> <td>Legal</td> </tr> </tbody> </table>	Setting	Recording paper	Original document	100%	Legal	Letter, A4	A4	Letter	92%	Letter	Letter	Legal	Legal	86%	A4	A4	Letter	A4	72%	Letter	Legal	A4	Legal
		Setting		Recording paper	Original document																					
		100%		Legal	Letter, A4																					
				A4	Letter																					
		92%		Letter	Letter																					
				Legal	Legal																					
		86%		A4	A4																					
Letter	A4																									
72%	Letter	Legal																								
	A4	Legal																								
<b>92%</b>																										
<b>86%</b>																										
<b>72%</b>																										
#39	<b>Changing the display contrast</b> <div style="border: 1px solid black; padding: 2px; width: fit-content;">LCD CONTRAST MODE=NORMAL [ ± ]</div>	<b>NORMAL</b>	"NORMAL": For normal contrast "DARKER": Used when the display contrast is too light.																							
		<b>DARKER</b>																								
#40	<b>Setting the silent detection</b> <div style="border: 1px solid black; padding: 2px; width: fit-content;">SILENT DETECT. MODE=OFF [ ± ]</div> If you use the unit with an answering machine and wish to receive faxes from older model fax machines, activate this feature.	<b>ON</b>	● If the other party's fax machine does not send a fax calling tone, select "ON". The unit detects a silent pause and activates the fax function. ● If you use an answering machine to give greeting messages and record incoming messages on a single cassette tape, select "OFF".																							
		<b>OFF</b>																								

(The default setting is in bold type.)

# Features Summary

## Advanced features (cont.)

### How to set menu options

1. Press **MENU**.
2. Press **◀** or **▶** until the following is displayed.
3. Press **+** or **-** until the desired setting is displayed.
4. Press **SET**.
5. Press **MENU**.

Display:

ADVANCED MODE  
PRESS SET

Press **SET** and press **◀** or **▶** until the desired feature is displayed.

#### Note:

- Step 3 may be slightly different depending on the feature.
- See page 49 for more details.

### Programming table (cont.)

Code	Feature & Display	Settings	How the unit operates
#41	<b>Changing the fax activation code</b> FAX ACTIVATION MODE=ON [ ± ] If you use an extension telephone and wish to use it to receive a fax, activate this feature, and enter the code (p. 43). • This code is also used to receive a voice message and a fax in the same call (p. 43).	<b>ON / CODE= * 9</b>	1. Follow steps 1 and 2 above. 2. Press <b>+</b> or <b>-</b> to select "ON". 3. Press <b>SET</b> . 4. Enter your code from 2 to 4 digits, using 0–9 and *. 5. Press <b>SET</b> . 6. Press <b>MENU</b> . • Do not enter "0000".
		OFF	
#44	<b>Setting the memory reception alert</b> RECEIVE ALERT MODE=ON [ ± ] To alert you with a beeping sound when a document which has been received is stored into memory due to some existing problem.	<b>ON</b>	If you are alerted by a slow beeping sound, clear the printing problem and make sure the unit is supplied with paper to print the stored document. The beeps will stop.
		OFF	
#46	<b>Setting the friendly reception</b> FRIENDLY RCV MODE=ON [ ± ] To receive a fax automatically when you answer a call and hear a fax calling tone (slow beep).	<b>ON</b>	"ON": You do not have to press <b>FAX START</b> for fax reception.
		OFF	
#49	<b>Setting the auto disconnection</b> AUTO DISCONNECT MODE=ON [ ± ] To answer a call with an extension telephone in TEL/FAX mode (p. 41).	<b>ON / CODE= * 0</b>	1. Follow steps 1 and 2 above. 2. Press <b>+</b> or <b>-</b> to select "ON". 3. Press <b>SET</b> . 4. Enter your code from 2 to 4 digits, using 0–9 and *. 5. Press <b>SET</b> . 6. Press <b>MENU</b> .
		OFF	

(The default setting is in bold type.)

# Features Summary

Code	Feature & Display	Settings	How the unit operates
#70	<b>Signaling your pager when your unit receives a fax</b> <div style="border: 1px solid black; padding: 2px; width: fit-content;">           FAX PAGER CALL            MODE=OFF [±]         </div> If you have a pager and wish to know when your unit receives a fax, activate this feature.	ON	See page 44 for details.
		OFF	
#76	<b>Setting the connecting tone</b> <div style="border: 1px solid black; padding: 2px; width: fit-content;">           CONNECTING TONE            MODE=ON [±]         </div> If you often have trouble when sending a fax, this feature allows you to hear connecting tones: fax tone, ring back tone and busy tone.	ON	You can confirm the status of the other party's machine. <ul style="list-style-type: none"> <li>● If the ring back tone continues, the other party's machine may not be a facsimile or may have run out of paper. Check with the other party.</li> <li>● The connecting tone volume cannot be adjusted.</li> </ul>
		OFF	
#77	<b>Changing the receive mode in the AUTO ANSWER setting</b> <div style="border: 1px solid black; padding: 2px; width: fit-content;">           AUTO ANSWER            MODE=FAX ONLY [±]         </div>	FAX ONLY	"FAX ONLY": Facsimile only mode (p. 39) "TEL/FAX": Telephone/Facsimile mode (p. 40, 41)
		TEL/FAX	
#78	<b>Changing the TEL/FAX delayed ring setting</b> <div style="border: 1px solid black; padding: 2px; width: fit-content;">           TEL/FAX RING            RINGS=2 [±]         </div> If you use an extension telephone in TEL/FAX mode, select the desired number of rings of the extension telephone.	1, 2, 3, 4	See pages 40 and 41 for details.
#80	<b>Resetting on advanced features to their default settings</b> <div style="border: 1px solid black; padding: 2px; width: fit-content;">           SET DEFAULT            RESET=NO [±]         </div>	YES	<ol style="list-style-type: none"> <li>1. Follow steps 1 and 2 on page 54.</li> <li>2. Press <b>+</b> or <b>-</b> to select "YES".</li> <li>3. Press <b>SET</b>.</li> <li>4. Press <b>SET</b> again.</li> <li>5. Press <b>MENU</b>.</li> </ol>
		NO	

(The default setting is in bold type.)

# Error Messages

## Reports

If your unit cannot send a fax, check the following:

- the number you dialed is correct,
- the other party's machine is a facsimile.

If the problem remains, correct it by following the communication message printed on the sending and journal reports (p. 30).

Communication message	Error code	Cause & solution
COMMUNICATION ERROR	40–42 46–52 58, 65 68, 72 FF	<ul style="list-style-type: none"><li>● A transmission or reception error occurred. Try again or check with the other party.</li></ul>
	43 44	<ul style="list-style-type: none"><li>● A line problem occurred. Connect the telephone line cord to a different jack and try again.</li><li>● An overseas transmission error occurred. Try using the overseas mode of feature #23 (p. 52).</li></ul>
DOCUMENT JAMMED	—	<ul style="list-style-type: none"><li>● The document is jammed. Remove the jammed document (p. 67).</li></ul>
ERROR-NOT YOUR UNIT	54 59 70	<ul style="list-style-type: none"><li>● A transmission or reception error occurred because of a problem with the other party's fax machine. Check with the other party.</li></ul>
MEMORY FULL	—	<ul style="list-style-type: none"><li>● The document was not received due to memory being full.</li></ul>
NO DOCUMENT	—	<ul style="list-style-type: none"><li>● The document was not fed into the unit properly. Reinsert the document and try again.</li></ul>
OTHER FAX NOT RESPOND	—	<ul style="list-style-type: none"><li>● The other party's fax machine is busy or has run out of recording paper. Try again.</li><li>● The document was not fed properly. Reinsert the document and try again.</li><li>● The other party's fax machine rings too many times. Send the fax manually – dial the number, confirm the fax tone, and press <b>FAX START</b>.</li><li>● The other party's machine is not a facsimile. Check with the other party.</li><li>● The number you dialed is not in service.</li></ul>
PRESSED THE STOP KEY	—	<ul style="list-style-type: none"><li>● <b>STOP</b> was pressed and fax communication was canceled.</li></ul>
THE COVER WAS OPENED	—	<ul style="list-style-type: none"><li>● The cover was opened. Close it and try again.</li></ul>
OK	—	<ul style="list-style-type: none"><li>● Fax communication was successful.</li></ul>



## Display

If the unit detects a problem, one or more of the following messages will appear on the display.

Display message	Cause & solution
CALL SERVICE	<ul style="list-style-type: none"> <li>There is something wrong with the unit. Contact our service personnel.</li> </ul>
CHECK DOCUMENT	<ul style="list-style-type: none"> <li>The document was not fed into the unit properly. Reinsert the document. If misfeeding occurs frequently, clean the document feeder rollers (p. 68) and try again.</li> </ul>
CHECK FILM	<ul style="list-style-type: none"> <li>The ink film is not installed. Install it (p. 64).</li> </ul>
CHECK MEMORY	<ul style="list-style-type: none"> <li>Memory (telephone numbers, parameters, etc.) has been erased. Re-program.</li> </ul>
CHECK PAPER	<ul style="list-style-type: none"> <li>The recording paper is not installed or the unit has run out of paper. Install paper and press <b>SET</b> to clear the message.</li> <li>The recording paper is not fed into the unit properly. Reinstall paper (p. 13) and press <b>SET</b> to clear the message.</li> <li>The recording paper has jammed near the recording paper entrance. Clear the jammed paper and press <b>SET</b> to clear the message (see "When paper has jammed near the recording paper entrance" on page 66). Do not install folded or heavily curled paper.</li> </ul>
COVER OPEN	<ul style="list-style-type: none"> <li>The cover is open. Close it.</li> </ul>
DIRECTORY FULL	<ul style="list-style-type: none"> <li>There is no space to store new items in the navigator directory. Erase unnecessary items (p. 22).</li> </ul>
FAX IN MEMORY	<ul style="list-style-type: none"> <li>The unit has a document in memory. See the other displayed message instructions to print out the document.</li> </ul>
FAX MEMORY FULL	<ul style="list-style-type: none"> <li>The memory is full of received documents due to a lack of recording paper or a recording paper jam. Install paper or clear the jammed paper.</li> <li>When performing memory transmission, the document being stored exceeds the memory capacity of the unit. Transmit the entire document manually.</li> </ul>
FILM EMPTY	<ul style="list-style-type: none"> <li>The ink film is empty. Replace the ink film with a new one (p. 64).</li> <li>The ink film is slack. Tighten it (see step 4 on page 64) and install again.</li> </ul>

(continued)

# Error Messages

Display message	Cause & solution
MEMORY FULL	<ul style="list-style-type: none"><li>● When making a copy, the document being stored exceeds the memory capacity of the unit. Press <b>(STOP)</b> to clear the message. Divide the document into sections.</li></ul>
MODEM ERROR	<ul style="list-style-type: none"><li>● There is something wrong with the modem circuit. Contact our service personnel.</li></ul>
NO FAX REPLY	<ul style="list-style-type: none"><li>● The other party's fax machine is busy or has run out of recording paper. Try again.</li></ul>
PAPER JAMMED	<ul style="list-style-type: none"><li>● A recording paper jam occurred. Clear the jammed paper (p. 65).</li></ul>
PLEASE WAIT	<ul style="list-style-type: none"><li>● The unit is checking that there is no slack on the ink film. Wait for a while.</li></ul>
REDIAL TIME OUT	<ul style="list-style-type: none"><li>● The other party's fax machine is busy or has run out of recording paper. Try again.</li></ul>
REMOVE DOCUMENT	<ul style="list-style-type: none"><li>● The document is jammed. Remove the jammed document (p. 67).</li><li>● Attempted to transmit a document longer than 600 mm. Press <b>(STOP)</b> to remove the document. Divide the document into two or more sheets and try again.</li></ul>
TRANSMIT ERROR	<ul style="list-style-type: none"><li>● A transmission error occurred. Try again.</li></ul>
UNIT OVERHEATED	<ul style="list-style-type: none"><li>● The unit is too hot. Let the unit cool</li></ul>

## When a function does not work, check here before requesting help

### General

Problem	Cause & solution
<b>I cannot make and receive calls.</b>	<ul style="list-style-type: none"> <li>● The power cord or telephone line cord is not connected. Check the connections (p. 14).</li> <li>● If you used a splitter to connect the unit, remove the splitter and connect the unit to the wall jack directly. If the unit operates properly, check the splitter.</li> </ul>
<b>I cannot make calls.</b>	<ul style="list-style-type: none"> <li>● The dialing mode setting is wrong. Change the setting of feature #13 (p. 51).</li> </ul>
<b>The unit does not work.</b>	<ul style="list-style-type: none"> <li>● Disconnect the unit from the telephone line and connect the line to a known working telephone. If the working telephone operates properly, contact our service personnel to have the unit repaired. If the working telephone does not operate properly, contact your telephone company.</li> </ul>
<b>The unit does not ring.</b>	<ul style="list-style-type: none"> <li>● The ringer volume is set to off. Adjust it (p. 19).</li> </ul>
<b>The unit displays the following though the paper is inserted.</b> <div style="border: 1px solid black; padding: 2px; width: fit-content; margin: 5px auto;">CHECK PAPER</div>	<ul style="list-style-type: none"> <li>● The paper is inserted halfway. Insert it correctly (p. 13) and press <b>SET</b> to clear the message.</li> </ul>
<b>The other party complains they only hear a fax tone and cannot talk.</b>	<ul style="list-style-type: none"> <li>● FAX ONLY mode is set. Tell the other party the number is only used for faxes.</li> <li>● Change to TEL mode (p. 38) or TEL/FAX mode (p. 40).</li> <li>● If you use a distinctive ring service, turn the AUTO ANSWER off so that the fax machine is in TEL mode.</li> <li>● If you use a distinctive ring service, make sure you have set each of the ring patterns to the same ring patterns of the telephone and fax number assigned by the telephone company (p. 45).</li> </ul>
<b>The <b>REDIAL/PAUSE</b> button does not function properly.</b>	<ul style="list-style-type: none"> <li>● If this button is pressed during dialing, a pause will be inserted. If pressed immediately after a dial tone is obtained, the last number dialed will be redialed.</li> </ul>
<b>The receive mode does not function properly.</b>	<ul style="list-style-type: none"> <li>● A Distinctive Ring pattern of feature #31 is set (p. 45).</li> <li>● TEL/FAX mode is set (p. 40, 41).</li> </ul>
<b>During programming, I cannot enter the code or ID number.</b>	<ul style="list-style-type: none"> <li>● All or part of the numbers are the same. Change the code or ID number of features #12 (p. 51), #41 (p. 54) and #49 (p. 54).</li> </ul>
<b>The ink film runs out quickly.</b>	<ul style="list-style-type: none"> <li>● The HELP printing function, copy function, and reports also use ink film.</li> </ul>
<b>The unit beeps.</b>	<ul style="list-style-type: none"> <li>● Recording paper has run out. Press <b>STOP</b> to stop the beeps and install paper.</li> </ul>

# Operations

## General (cont.)

Problem	Cause & solution
Whenever I try to retrieve my voice mail messages, the retrieval is interrupted by the fax tone.	<ul style="list-style-type: none"> <li>You are probably entering *98 or *99 to retrieve your messages. *9 is the default setting for the fax activation code. If you use a voice mail service, set the fax activation feature to off or reprogram the activation code (feature #41 on page 54).</li> </ul>

## Fax – sending

Problem	Cause & solution
I cannot send documents.	<ul style="list-style-type: none"> <li>The telephone line cord is connected to the EXT jack on the unit. Connect to the LINE jack (p. 14).</li> <li>The other party's fax machine is busy or has run out of recording paper. Try again.</li> <li>The other party's machine is not a facsimile. Check with the other party.</li> <li>The other party's fax machine rings too many times. Send the fax manually – dial the number, confirm the fax tone, then press <b>FAX START</b>.</li> </ul>
The other party complains that letters on their received document are distorted or not clear.	<ul style="list-style-type: none"> <li>If your line has special telephone services such as call waiting, the service may have been activated during fax transmission. Connect the unit to a line that does not have these services.</li> <li>The extension telephone on the same line is off the hook. Hang up the extension telephone and try again.</li> <li>Try copying the document. If the copied image is clear, there may be something wrong with the other party's machine.</li> </ul>
The other party complains that dirty patterns or black lines appear on their received document.	<ul style="list-style-type: none"> <li>The glass or rollers are dirty. Clean them (p. 68).</li> </ul>
I cannot send a fax overseas.	<ul style="list-style-type: none"> <li>Use the overseas transmission mode of feature #23 (p. 52).</li> <li>Add two pauses at the end of the telephone number or dial manually.</li> </ul>

## Fax – receiving

Problem	Cause & solution
I cannot receive documents.	<ul style="list-style-type: none"> <li>The telephone line cord is connected to the EXT jack on the unit. Connect to the LINE jack (p. 14).</li> </ul>
I cannot receive documents automatically.	<ul style="list-style-type: none"> <li>The receive mode is set to TEL mode. Set to FAX ONLY mode (p. 39) or TEL/FAX mode (p. 40).</li> <li>The time taken to answer the call is too long. Decrease the number of rings of features #06 (p. 50), #30 (p. 53) and #78 (p. 55).</li> </ul>

(continued)

## Fax – receiving (cont.)

Problem	Cause & solution
<p>The display shows the following, but faxes are not received.</p> <div style="border: 1px solid black; padding: 5px; width: fit-content;">CONNECTING.....</div>	<ul style="list-style-type: none"> <li>● The incoming call is not a fax. Change the receive mode to TEL mode (p. 38).</li> </ul>
<p>A blank sheet is ejected.</p>	<ul style="list-style-type: none"> <li>● If a blank sheet is ejected after the received document is printed out, the receiving reduction rate is not programmed correctly. Program the proper rate in feature #36 (p. 53).</li> <li>● The other party placed the document in their fax machine the wrong way. Check with the other party.</li> </ul>
<p>A white line or a dirty pattern appears on your recording paper.</p>	<ul style="list-style-type: none"> <li>● The glass or rollers are dirty. Clean them (p. 68).</li> </ul>
<p>The printing quality is poor.</p>	<ul style="list-style-type: none"> <li>● The other party sent a faint document. Ask them to send a clearer copy of the document.</li> <li>● The thermal head is dirty. Clean it (p. 68).</li> <li>● Some paper has instructions recommending which side to print on. Try turning the paper over. We recommend smooth paper such as Hammermill Jet Print for clearer printing.</li> <li>● You may have used paper with a cotton and/or fiber content that is over 20%, such as letterhead or resume paper. We recommend smooth paper such as Hammermill Jet Print for clearer printing.</li> </ul>

## Receive mode

Problem	Cause & solution
<p>I cannot select the desired receive mode.</p>	<ul style="list-style-type: none"> <li>● If you want to set FAX ONLY or TEL/FAX mode:               <ul style="list-style-type: none"> <li>— select the desired mode using feature #77 (p. 55), and</li> <li>— press <b>AUTO ANSWER</b> to turn on the arrow (▼) on the right of the display.</li> </ul> <div style="text-align: right; margin-top: 10px;">                     Display: <div style="border: 1px solid black; padding: 2px 10px;">▼</div> ON                 </div> </li> <li>● If you want to set TEL mode:               <ul style="list-style-type: none"> <li>— press <b>AUTO ANSWER</b> to turn off the arrow (▼) on the right of the display.</li> </ul> <div style="text-align: right; margin-top: 10px;"> <div style="border: 1px solid black; width: 100px; height: 20px;"></div> ON                 </div> </li> </ul>
<p>The other party complains that they cannot send a document.</p>	<ul style="list-style-type: none"> <li>● The unit is not in AUTO ANSWER mode. Press <b>AUTO ANSWER</b> to turn on the arrow (▼) on the right of the display.</li> </ul> <div style="text-align: right; margin-top: 10px;"> <div style="border: 1px solid black; padding: 2px 10px;">▼</div> ON                 </div>

# Operations

## Copying

Problem	Cause & solution
The unit does not make a copy.	<ul style="list-style-type: none"> <li>You cannot make a copy during programming. Make the copy after programming or stop programming.</li> </ul>
A black line, a white line or a dirty pattern appears on the copied document.	<ul style="list-style-type: none"> <li>The glass or rollers are dirty. Clean them (p. 68).</li> </ul>
The copied image is distorted.	<ul style="list-style-type: none"> <li>The thermal head is dirty. Clean it (p. 68).</li> </ul>
The printing quality is poor. Original                  Copy 	<ul style="list-style-type: none"> <li>Some paper has instructions recommending which side to print on. Try turning the paper over. We recommend smooth paper such as Hammermill Jet Print for clearer printing.</li> <li>You may have used paper with a cotton and/or fiber content that is over 20%, such as letterhead or resume paper. We recommend smooth paper such as Hammermill Jet Print for clearer printing.</li> </ul>

## Using an answering machine

Problem	Cause & solution
I cannot receive documents automatically.	<ul style="list-style-type: none"> <li>Your greeting message on the answering machine is too long. Shorten the message (up to 10 seconds).</li> <li>The answering machine rings too many times. Set to 1 or 2 rings.</li> </ul>
I cannot receive voice messages.	<ul style="list-style-type: none"> <li>Check if the answering machine is turned on and connected to the fax machine properly (p. 42).</li> <li>Set the number of rings on the answering machine to 1 or 2.</li> </ul>
I cannot retrieve recorded voice messages on the answering machine from a remote location.	<ul style="list-style-type: none"> <li>The remote access code on your answering machine is the same as your fax activation code. Set a different number for features #12 (p. 51) and #41 (p. 54).</li> <li>You did not program your remote access code in your fax machine correctly. Program the same code that is programmed on the answering machine to the fax machine with feature #12 (p. 51).</li> </ul>
I pressed the remote access code to access the answering machine remotely, but the line was disconnected.	<ul style="list-style-type: none"> <li>The code may include “#” which is used for certain features provided by telephone companies. Change the code on the answering machine to another number which does not include “#”. Also change the code of the fax machine with feature #12 (p. 51).</li> </ul>
Callers complain that they cannot send a document.	<ul style="list-style-type: none"> <li>Your answering machine has run out of recording tape. Rewind the tape to record messages.</li> <li>You set the answering machine to only give a greeting message.</li> </ul>

## If a power failure occurs

---

---

- The unit will not function.
- The unit is not designed for making emergency telephone calls when the power fails. Alternative arrangements should be made for access to emergency services.
- Fax transmission and reception will be interrupted.
- If delayed transmission of feature #25 (p. 52) is programmed and the start time has passed during a power failure, transmission will be attempted soon after power is restored.
- If fax documents are stored in memory, they will be lost. When power is restored, a power down report will be printed out stating which contents in memory have been erased.

# Replacement

## Replacing the film cartridge

When the unit detects the end of the ink film, the following will be displayed.

Display: FILM EMPTY The ink film is empty. Install a new film cartridge.

The following is available for replacement. For further details, see page 7.

**Model No. KX-FA65:** Film cartridge

**1** Open the cover by pressing the cover open button.

**2** Remove the used film cartridge.

**3** Remove the film stopper from the new film cartridge by pressing it up.

**4** If the ink film is slack, tighten it by winding the gears.

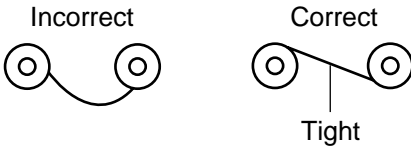

**5** Turn the film cartridge over so that the "BACK" is facing up.

**6** Insert the new film cartridge by first placing the front of the cartridge into the unit and then lowering the "BACK" of the cartridge into place.

**7** Close the cover securely by pushing down on the dotted area at both ends.

- The unit will check that there is no slack on the ink film. The following will be displayed.

Display: PLEASE WAIT

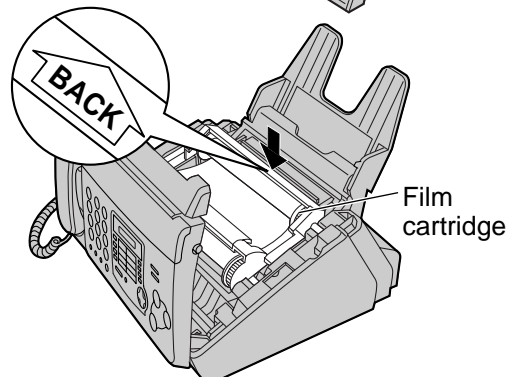
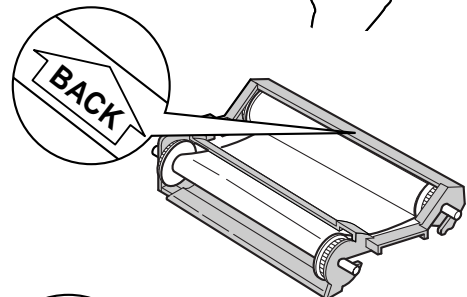
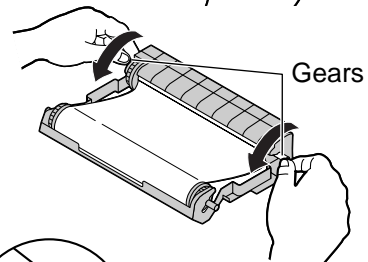
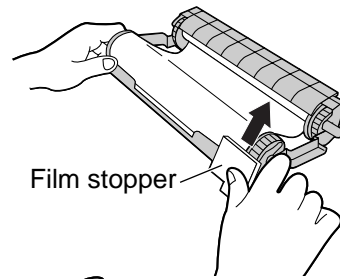
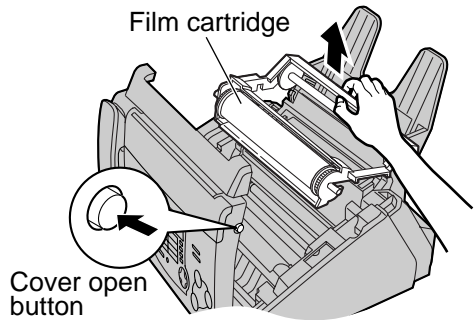



## Recording paper jam

If the unit does not eject any recording paper during reception or copying, the recording paper has jammed.

### When paper has jammed under the film cartridge

The display will show the following.

Display: PAPER JAMMED

**1** Open the cover by pressing the cover open button.

**2** Remove the film cartridge.

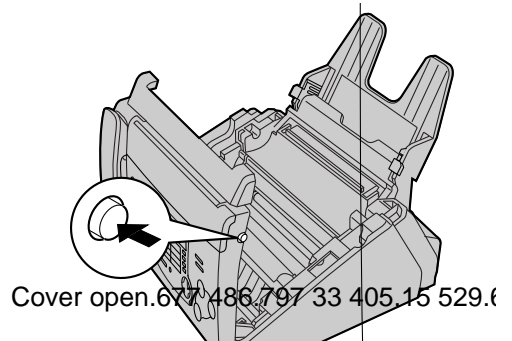

**3** Remove the jammed recording paper.

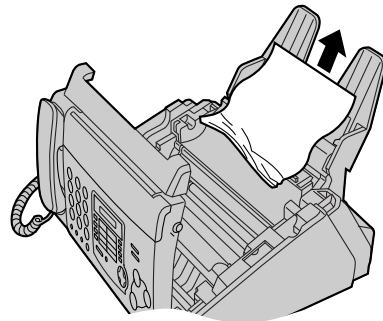

**4** If the ink film is slack, turn the film cartridge over and tighten it by winding the gears.

**5** Turn the film cartridge over so that the "BACK" is facing up.

**6** Replace the film cartridge by first placing the front of the cartridge into the unit and then lowering the "BACK" of the cartridge into place.

**7** Close the cover securely by pushing down on the dotted area at both ends.

## When paper has jammed near the recording paper entrance

The display will show the following.

Display:

CHECK PAPER

PRESS SET

**1** Pull the tension bar forward and hold open while pulling out the jammed recording paper from the recording paper entrance.

**2** Press **SET** to clear the message.

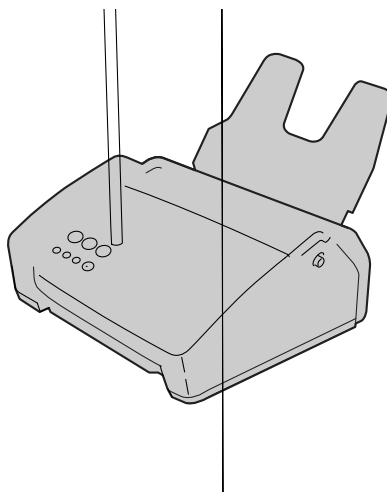

## Document jams – sending

If the unit does not release the document during feeding, remove the jammed document as follows.

- 1** Open the cover by pressing the cover open button.
- 2** Remove the jammed document carefully.
- 3** Close the cover securely by pushing down on the dotted area at both ends.

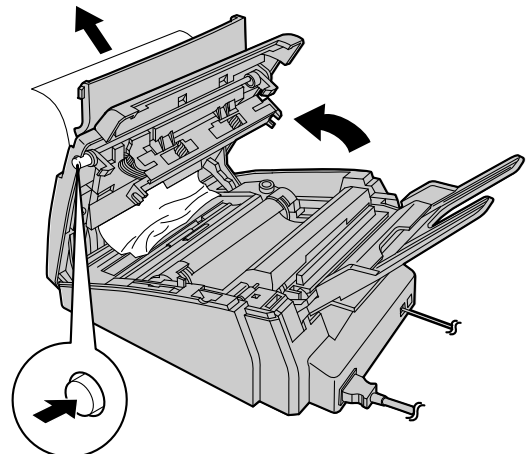

Cover open button

### Note:

- Do not pull out the jammed paper forcibly before opening the cover.

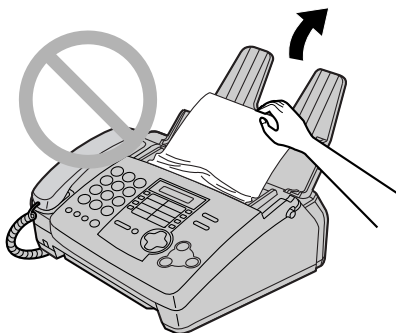

# Cleaning

## Document feeder

If misfeeding occurs frequently or if dirty patterns or black bands appear on a copied or transmitted document, clean the document feeder.

- 1** Disconnect the power cord and the telephone line cord.
- 2** Open the cover by pressing the cover open button.
- 3** Clean the document feeder rollers, sub roller and rubber flap with a cloth moistened with isopropyl rubbing alcohol, and let all parts dry thoroughly.
- 4** Clean the white plate and glass with a soft dry cloth.
  - Do not touch the lever.
- 5** Close the cover securely by pushing down on the dotted area at both ends.
- 6** Connect the power cord and the telephone line cord.

### Caution:

- Do not use paper products, such as paper towels or tissues, to clean the inside of the unit.

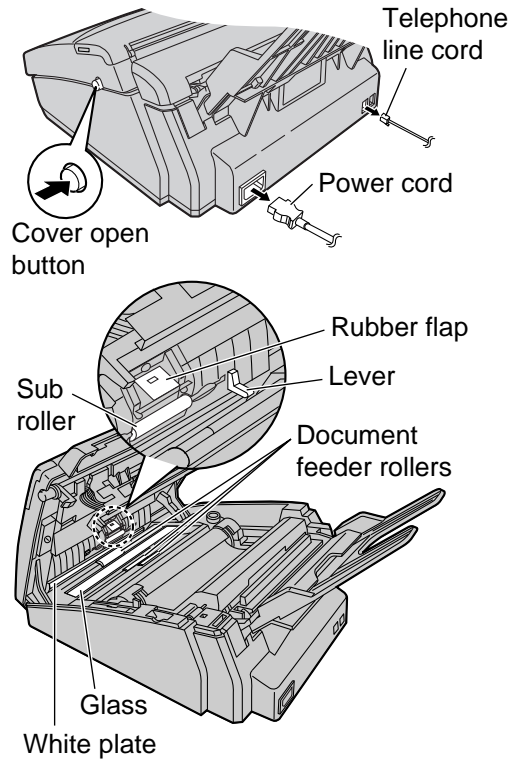

## Thermal head, bar and projection bar

If dirty patterns or black or white bands appear on a copied or received document, clean the thermal head, bar and projection bar.

- 1** Disconnect the power cord and the telephone line cord.
- 2** Open the cover by pressing the cover open button and remove the film cartridge.
- 3** Clean the thermal head, bar and projection bar with a cloth moistened with isopropyl rubbing alcohol, and let it dry thoroughly.
- 4** Replace the cartridge and close the cover securely by pushing down on the dotted area at both ends.
- 5** Connect the power cord and the telephone line cord.

### Caution:

- To prevent a malfunction due to static electricity, do not use a dry cloth and do not touch the thermal head directly with your fingers.

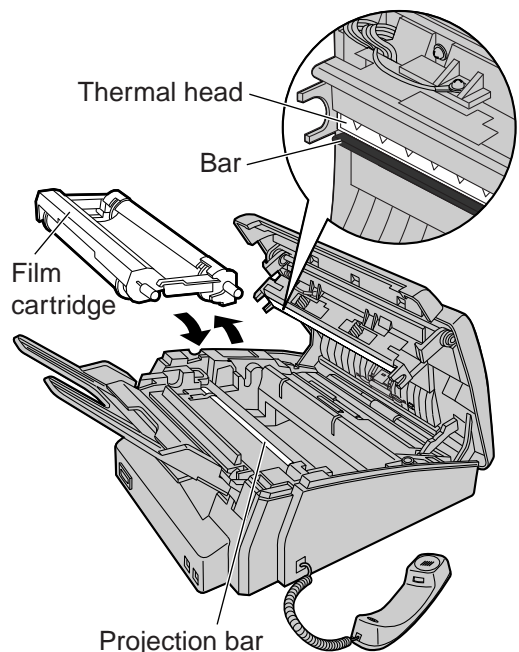

## Reference lists and reports

You can print out the following lists and reports for your reference.

**Setup list:** provides you with the current settings of the basic and advanced programming features (p. 50–55).

**Telephone number list:** provides you with names and telephone numbers which are stored in one-touch dial and navigator directory.

**Journal report:** keeps records of fax transmission and reception. This report will be printed automatically after every 30 fax communications (p. 30).

**Printer test list:** allows you to check the print quality of your unit. If the test print has a dirty pattern, or blurred points or lines, clean the thermal head (p. 68).

**Broadcast programming list:** provides you with items which are stored in the broadcast feature (p. 33).

**Caller ID list:** keeps records of the last 30 callers after subscribing to a Caller ID service. This report will be printed automatically after every 30 callers (p. 26).

**1** Press **MENU** three times.

Display: PRINT REPORT  
PRESS NAVI. [◀ ▶]

**2** Press ◀ or ▶ until the desired item is displayed.

SETUP LIST  
PRESS SET

TEL NO. LIST  
PRESS SET

JOURNAL REPORT  
PRESS SET

PRINTER TEST  
PRESS SET

BROADCAST LIST  
PRESS SET

CALLER ID LIST  
PRESS SET

**3** Press **SET** to start printing.

PRINTING

- To stop printing, press **STOP**.
- After printing, the printed item will be displayed.

**4** Press **MENU**.

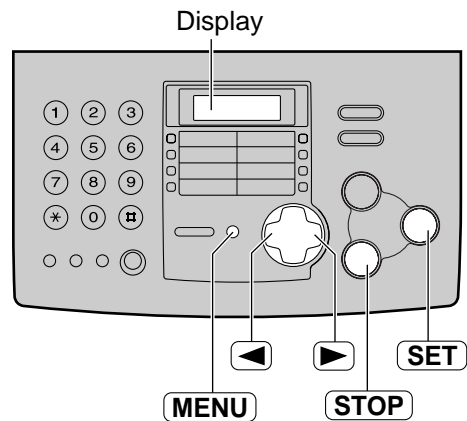

## List of FCC requirements and information --- ---

If required by the telephone company, inform them of the following.

- FCC Registration No.:  
(found on the rear of the unit)
- Ringer Equivalence No.:  
(found on the rear of the unit)
- The particular telephone line to which the equipment is connected.

This unit must not be connected to a coin operated line. If you are on a party line, check with your local telephone company.

### **Ringer Equivalence Number (REN):**

This REN is useful in determining the quantity of devices you may connect to your telephone line and still have all of those devices ring when your telephone number is called. In most but not all areas, the sum of the REN's of all devices connected to one line should not exceed five (5.0). To be certain of the number of devices you may connect to your line, as determined by the REN, you should contact your local telephone company to determine the maximum REN for your calling area.

In the event that terminal equipment causes harm to the telephone network, the telephone company should notify the customer, if possible, that service may be stopped. However, where prior notice is impractical, the company may temporarily cease service providing that they:

- a) Promptly notify the customer.
- b) Give the customer an opportunity to correct the problem with their equipment.
- c) Inform the customer of the right to bring a complaint to the Federal Communication Commission pursuant to procedures set out in FCC Rules and Regulations Subpart E of Part 68.

The Telephone Company may make changes in its communications facilities, equipment operations, or procedures where such action is reasonably required in the operation of its business and is not inconsistent with the rules and regulations in FCC Part 68. If such changes can be reasonably expected to render any customer terminal equipment incompatible with telephone company communications facilities, or require modification or

alteration of such terminal equipment, or otherwise materially affect its use or performance, the customer shall be given adequate notice in writing, to allow the customer an opportunity to maintain uninterrupted service.

### **CAUTION:**

Any changes or modifications not expressly approved by the party responsible for compliance could void the user's authority to operate this device.

When programming emergency numbers and/or making test calls to emergency numbers:

1. Remain on the line and briefly explain to the dispatcher the reason for the call before hanging up.
2. Perform such activities in the off-peak hours; such as early morning or late evenings.

This telephone provides magnetic coupling to hearing aids.

### **NOTE:**

This equipment has been tested and found to comply with the limits for a Class B digital device, pursuant to Part 15 of the FCC Rules. These limits are designed to provide reasonable protection against harmful interference in a residential installation. This equipment generates, uses, and can radiate radio frequency energy and, if not installed and used in accordance with the instructions, may cause harmful interference to radio communications. However, there is no guarantee that interference will not occur in a particular installation. If this equipment does cause harmful interference to radio or television reception, which can be determined by turning the equipment off and on, the user is encouraged to try to correct the interference by one or more of the following measures:

- Reorient or relocate the receiving antenna.
- Increase the separation between the equipment and receiver.
- Connect the equipment into an outlet on a circuit different from that to which the receiver is connected.
- Consult the dealer or an experienced radio/TV technician for help.

Have any questions? CALL 1-800-HELP-FAX (1-800-435-7329) on:  
operating the unit, getting repair service, and/or getting supplies.

**Panasonic Consumer Electronics Company,  
Division of Matsushita Electric Corporation  
of America**

One Panasonic Way,  
Secaucus, New Jersey 07094

**Panasonic Sales Company,  
Division of Matsushita Electric of  
Puerto Rico, Inc.**

Ave. 65 de Infantería, Km. 9.5, San Gabriel  
Industrial Park, Carolina, Puerto Rico 00985

## PANASONIC Facsimile Products Limited Warranty

In the event of a defect in materials or workmanship, Panasonic Consumer Electronics Company or Panasonic Sales Company (collectively referred to as "the warrantor"), will repair this product with new or refurbished parts, free of charge, in the USA or Puerto Rico for 6-month limited warranty from the date of original purchase.

**This Limited Warranty Excludes both Labor and Parts for:** batteries, antennas, ink film, toner cartridge, drum unit, ink cartridge and cosmetic parts (cabinet).

Carry-in or mail-in service in the USA or Puerto Rico can be obtained during the warranty period by contacting a Panasonic Services Company (PASC) Factory Servicenter listed in the Servicenter Directory. Or call, toll free, 1-800-HELP-FAX (1-800-435-7329) to locate a PASC Factory Servicenter. Carry-in or mail-in service in Puerto Rico can be obtained during the warranty period by calling the Panasonic Sales Company telephone number listed in the Servicenter Directory.

This warranty is extended only to the original purchaser. A purchase receipt or other proof of date of original purchase will be required before warranty service is rendered.

This warranty only covers failures due to defects in material or workmanship which occur during normal use. The inability of this product to interface with any specific computer is not a manufacturing defect and is outside of the scope of this Limited Warranty. In no event shall the warrantor be liable by reason of such incompatibility. The warranty does not cover damages which occur in shipment, or failures which are caused by products not supplied by the warrantor such as non Panasonic ink film, toner cartridge or drum unit, or failures which result from accident, misuse, abuse, neglect, mishandling, faulty installation, misapplication, set-up adjustments, improper operation or maintenance, alteration, modification, power line surge, improper voltage supply, lightning damage, signal reception problems, rental use of the product, or service by anyone other than a PASC Factory Servicenter or a PASC authorized Servicenter, or damage that is attributable to acts of God.

### LIMITS AND EXCLUSIONS

There are no express warranties except as listed above.

THE WARRANTOR SHALL NOT BE LIABLE FOR INCIDENTAL OR CONSEQUENTIAL DAMAGES RESULTING FROM THE USE OF THIS PRODUCT, OR ARISING OUT OF ANY BREACH OF THIS WARRANTY. ALL EXPRESS AND IMPLIED WARRANTIES, INCLUDING THE WARRANTIES OF MERCHANTABILITY, ARE LIMITED TO THE APPLICABLE WARRANTY PERIOD SET FORTH ABOVE.

Some states do not allow the exclusion or limitation of incidental or consequential damages, or limitations on how long an implied warranty lasts, so the above exclusions or limitations may not apply to you.

This warranty gives you specific legal rights and you may also have other rights which vary from state to state. If a problem with this product develops during or after the warranty period, you may contact your dealer or Servicenter. If the problem is not handled to your satisfaction, then write to the Customer Satisfaction Center at the company address indicated above.

### **For product service**

- Servicenters are listed on next page.
- Call toll-free 1-800-HELP-FAX (1-800-435-7329) for the location of an authorized servicenter.
- After the warranty has expired, please contact our Continued Services Technical Support Line at 1-900-555-PANA (1-900-555-7262). If you have difficulty reaching this number, it may be blocked by your phone company. Please contact your local phone company to correct this.

### **When you ship the product**

- Carefully pack your unit, preferably in the original carton.
- Attach a letter, detailing the symptom or problem, to the outside of the carton.
- Send the unit to an authorized servicenter, prepaid and adequately insured.
- Do not send your unit to the Panasonic Consumer Electronics Company or to any executive or regional sales offices. These locations do not repair consumer products.

# Servicenter Directory

## Servicenter directory

To obtain technical support within the warranty period or product service, please contact: 1-800-HELP-FAX (1-800-435-7329), Monday-Friday 9am-8pm EST.

To obtain continued technical support after the warranty has expired, please contact: 1-900-555-PANA (1-900-555-7262) for support on a fee basis.

Web Site: [www.panasonic.com](http://www.panasonic.com)

(for customers in the USA or Puerto Rico ONLY)

You can purchase parts, accessories or locate your nearest servicenter by visiting our Web Site.

### Factory Servicenter Locations

<b>CALIFORNIA</b> 6550 Katella Avenue Cypress, CA 90630  800 Dubuque Avenue S. San Francisco, CA 94080  3878 Ruffin Road Suite A San Diego, CA 92123  <b>FLORIDA</b> 3700 North 29 <sup>th</sup> Avenue Suite 102 Hollywood, FL 33020	<b>GEORGIA</b> 8655 Roswell Road Suite 100 Atlanta, GA 30350  <b>ILLINOIS</b> 1709 North Randall Road Elgin, IL 60123  <b>MASSACHUSETTS</b> 60 Glacier Drive Suite G Westwood, MA 02090	<b>MINNESOTA</b> 7850-12 <sup>th</sup> Avenue South Airport Business Center Bloomington, MN 55425  <b>OHIO</b> 2236 Waycross Road Civic Center Plaza Forest Park, OH 45240  <b>PENNSYLVANIA</b> 2221 Cabot Blvd. West Suite B Langhorne, PA 19047	<b>TEXAS</b> 13615 Welch Road Suite 101 Farmers Branch, TX 75244  <b>WASHINGTON</b> 20425-84 <sup>th</sup> Avenue South Kent, WA 98032  <b>HAWAII</b> 99-859 Iwaiwa Street Aiea, Hawaii 96701 Phone (808) 488-1996 Fax (808) 486-4369
------------------------------------------------------------------------------------------------------------------------------------------------------------------------------------------------------------------------------------------------------------------------------------	-----------------------------------------------------------------------------------------------------------------------------------------------------------------------------------------------------------------------------	------------------------------------------------------------------------------------------------------------------------------------------------------------------------------------------------------------------------------------------------------------------------------------------	---------------------------------------------------------------------------------------------------------------------------------------------------------------------------------------------------------------------------------------------------------------------------------

### Service in Puerto Rico

Matsushita Electric of Puerto Rico, Inc. Panasonic Sales Company / Factory Servicenter:  
Ave. 65 de Infantería, Km. 9.5, San Gabriel Industrial Park, Carolina, Puerto Rico 00985  
Phone (787) 750-4300 Fax (787) 768-2910

As of Aug 2001



## Technical data about this product

<b>Applicable Lines:</b>	Public Switched Telephone Network
<b>Document Size:</b>	Max. 216 mm (8½") in width Max. 600 mm (23⅝") in length
<b>Effective Scanning Width:</b>	208 mm (8¾")
<b>Recording Paper Size:</b>	Letter: 216 mm x 279 mm (8½" x 11") Legal: 216 mm x 356 mm (8½" x 14") A4: 210 mm x 297 mm (8¼" x 11⅛")
<b>Effective Printing Width:</b>	208 mm (8¾")
<b>Transmission Time*:</b>	Approx. 15 s/page (Original mode)**
<b>Scanning Density:</b>	Horizontal: 8 pels/mm (203 pels/inch) Vertical: 3.85 lines/mm (98 lines/inch) –STANDARD 7.7 lines/mm (196 lines/inch) –FINE/PHOTO 15.4 lines/mm (392 lines/inch) –SUPER FINE
<b>Halftone Level:</b>	64-level
<b>Scanner Type:</b>	Contact Image Sensor (CIS)
<b>Printer Type:</b>	Thermal Transfer on plain paper
<b>Data Compression System:</b>	Modified Huffman (MH), Modified READ (MR)
<b>Modem Speed:</b>	9,600 / 7,200 / 4,800 / 2,400 bps; Automatic Fallback
<b>Operating Environment:</b>	5 °C – 35 °C (41 °F – 95 °F), 20% – 80% RH (Relative Humidity)
<b>Dimensions (H x W x D):</b>	143 mm x 325 mm x 308 mm (5⅝" x 12⅜" x 12⅛")
<b>Mass (Weight):</b>	Approx. 4.1 kg (9 lb.)
<b>Power Consumption:</b>	Standby: Approx. 3.5 W Transmission: Approx. 14 W Reception: Approx. 42 W (When receiving a 20% black document) Copy: Approx. 42 W (When copying a 20% black document) Maximum: Approx. 135 W (When copying a 100% black document)
<b>Power Supply:</b>	120 V AC, 60 Hz
<b>Fax Memory Capacity:</b>	Approx. 25 pages of memory transmission Approx. 28 pages of memory reception (Based on the ITU-T No. 1 Test Chart in standard resolution.)

\* Transmission speed depends upon the contents of the pages, resolution, telephone line conditions and capability of the other party's machine.

\*\* Transmission speed is based upon the ITU-T No. 1 Test Chart and original mode.

If the capability of the other party's machine is inferior to your unit, the transmission time may be longer.

### ITU-T No. 1 Test Chart

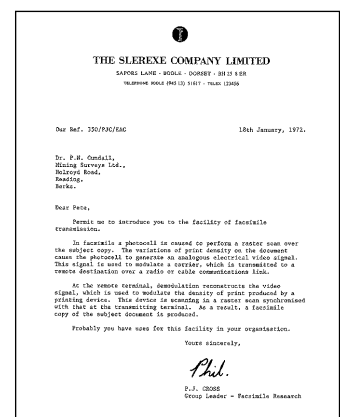

### Note:

- Any details given in these instructions are subject to change without notice.
- The pictures and illustrations in these instructions may vary slightly from the actual product.

## Index

- A**
  - A4 paper guides .....12
  - Accessories ..... 6, 7
  - Advanced features .....52–55
  - Alert
    - (Memory reception)(Feature #44) .54
  - Answering machine .....42
  - AUTO ANSWER button .....38–40
  - Auto Answer setting (Feature #77) .55
  - Auto disconnection (Feature #49) .54
- B**
  - Basic features .....50, 51
  - BROADCAST key .....33, 35
  - Broadcast sending report .....35
  - Broadcast transmission .....32
- C**
  - Caller ID .....24
    - (Calling back) .....25
    - (Storing) .....27
  - Caller ID list (Feature #26) .....26, 52
  - CALLER ID button .....25
  - Character table .....17
  - Cleaning .....68
  - Collation .....48
  - Communication messages .....56
  - Connecting tone (Feature #76) .....55
  - Connections .....14
  - Copy .....46
- D**
  - Date and time (Feature #01) .15, 50
  - Delayed transmission (Feature #25) .52
  - Delete button .....17
  - Dialing mode (Feature #13) .....51
  - Display
    - (Contrast)(Feature #39) .....53
    - (Error messages) .....57, 58
  - Distinctive ring service
    - (Feature #31) .....45
  - Document jam .....67
  - Document size .....30
- E**
  - Enlarge copy .....47
  - Error messages .....56–58
  - Extension telephone .....41, 43
- F**
  - Facsimile telephone number
    - (Feature #03) .....18, 50
  - Fax activation code
    - (Feature #41) .....43, 54
  - Fax auto redial .....31
  - FAX ONLY mode .....39
  - Fax receiving .....36, 37
  - FAX ring setting (Feature #06) .....50
  - Film cartridge .....64
  - Friendly reception (Feature #46) .38, 54
- H**
  - Handset receiver volume .....19
  - HELP button .....8
  - Hyphen button .....17
- I**
  - Insert button .....17
- J**
  - Jams .....65–67
  - Journal report (Feature #22) .30, 52
- L**
  - List
    - (Broadcast programming) .....69
    - (Broadcast sending) .....35
    - (Caller ID) .....69
    - (Journal) .....30, 69
    - (Printer test) .....69
    - (Sending) .....30
    - (Setup) .....69
    - (Telephone number) .....69
  - Logo (Feature #02) .....16, 50
  - LOWER key .....20, 23, 31
- M**
  - Memory reception .....38
  - MONITOR button .....28
  - Monitor volume .....19
- N**
  - NAME/TEL NO. key .....25
  - Navigator directory
    - (Making a phone call) .....23
    - (Selecting characters) .....17
    - (Sending faxes) .....31
    - (Storing) .....21
- O**
  - One-touch dial
    - (Making a phone call) .....23
    - (Sending faxes) .....31
    - (Storing) .....20
  - Overseas mode (Feature #23) .....52
- P**
  - Pager call (Feature #70) .....44, 55
  - Paper jam .....65
  - Paper size (Feature #16) .....51
  - Paper stacker .....11
  - Paper tray .....12
  - Power down report .....63
  - Power failure .....63
  - Power supply .....73
- Q**
  - Quick scan (Feature #34) .29, 48, 53
- R**
  - Receiving alert (Feature #44) .....54
  - Receiving reduction (Feature #36) .53

- Receiving setting . . . . .36, 37
- Recording paper . . . . .13
- Recording paper size . . . . .73
- REDIAL button . . . . .29
- Reduce copy . . . . .47
- Remote activation ID (Feature #12) . .51
- Report
  - (Broadcast sending) . . . . .35
  - (Journal) . . . . .30, 69
  - (Sending) . . . . .30
- Reset (Feature #80) . . . . .55
- Resolution . . . . .29, 46
- Ring setting
  - (FAX ONLY)(Feature #06) . . . . .50
  - (Silent fax)(Feature #30) . . . . .53
  - (TEL/FAX)(Feature #78) . . . . .55
- Ring detection (Feature #31) . . . . .45
- Ringer pattern (Feature #17) . . . .19, 51
- Ringer volume . . . . .19

**S**

- Sending**
  - (Broadcast) . . . . .35
  - (From memory) . . . . .29
  - (Manually) . . . . .29
  - (Navigator directory) . . . . .31
  - (One-touch dial) . . . . .31
- Sending report (Feature #04) . . .30, 50
- Set default (Feature #80) . . . . .55
- Silent detection (Feature #40) . . . . .53
- Silent fax recognition ring setting
  - (Feature #30) . . . . .40, 41, 53
- Specifications . . . . .73
- Storing
  - (Broadcast) . . . . .33
  - (Navigator directory) . . . . .21
  - (One-touch dial) . . . . .20

**T**

- TEL mode** . . . . .38
- TEL/FAX delayed ring setting
  - (Feature #78) . . . . .40, 41, 55
- TEL/FAX mode . . . . .40
- Transmission
  - (Broadcast) . . . . .35
  - (From memory) . . . . .29
  - (Manually) . . . . .29
  - (Navigator directory) . . . . .31
  - (One-touch dial) . . . . .31

**V**

- Voice contact** . . . . .28
- VOLUME button** . . . . .19

## Program index

### Basic features

<i>Code</i>	<i>Feature name</i>	
#01	Date and time	15, 50
#02	Your logo	16, 50
#03	Your facsimile telephone number	18, 50
#04	Sending report	30, 50
#06	FAX ring setting	50
#12	Remote activation ID	51
#13	Dialing mode	51
#16	Paper size	51
#17	Ringer pattern	19, 51

### Advanced features

<i>Code</i>	<i>Feature name</i>	
#22	Journal report	30, 52
#23	Overseas mode	52
#25	Delayed transmission	52
#26	Caller ID list	26, 52
#30	Silent fax ring setting	40, 41, 53
#31	Ring detection	45, 53
#34	Quick scan	29, 48, 53
#36	Receiving reduction	53
#39	Display contrast	53
#40	Silent detection	53
#41	Remote fax activation code	43, 54
#44	Fax receiving alert	54
#46	Friendly reception	38, 54
#49	Auto disconnect	54
#70	Fax pager call	44, 55
#76	Connecting tone	55
#77	Auto answer	55
#78	TEL/FAX ring setting	40, 41, 55
#80	Reset advanced features	55

## Panasonic FAX ADVANTAGE PROGRAM

*Free peace of mind,  
direct from Panasonic*

**NO EXTRA COST**



- **6-month limited warranty<sup>1</sup>: parts, labor, and toll-free help line<sup>2</sup>**
- **Free replacement<sup>3</sup> and repair program**

### **The Panasonic Fax Advantage Consumer Service Program.**

Panasonic knows that if your fax machine is not up and running, neither is your business. That's why we created the Panasonic Fax Advantage Program. Included at no extra cost with the purchase of a new and unused Panasonic Fax Machine, the Fax Advantage Program can provide a free replacement unit<sup>3</sup> if your original unit is in need of repair.

#### **Here's how it works:**

1. If you have a problem with your fax that you purchased new and unused while it is covered by the period of limited warranty<sup>1</sup>, call our toll-free help-line at 1-800-HELP-FAX<sup>2</sup>.
2. Talk to one of our technical experts to diagnose your problem over the phone.
3. If repairs are necessary and you are entitled to service under the terms and conditions of the limited warranty<sup>4</sup>, we will send a refurbished replacement unit to you by UPS Ground service delivery. The shipping method is upgradable for an extra charge.

A second option available under our limited warranty is to mail-in or carry-in your fax to one of our Regional Service centers, where the unit will be repaired and returned to you.

#### **Instructions:**

If you choose to receive a replacement unit under the Fax Advantage Program, Panasonic will provide a replacement unit which will be completely refurbished, quality-tested by Panasonic technicians and individually hand-inspected before it is shipped to you. You will keep the replacement unit and send the original unit to us in the replacement unit's box. UPS will pick up the unit at no charge to you, should it be determined that you are entitled to warranty service. A proof-of-purchase must be included with the returned product. Any unit that is replaced by Panasonic and not shipped with proper proof-of-purchase by you will be subject to a minimum \$100.00 charge. The original unit must be properly packaged in the same manner as the replacement unit, utilizing the packing materials provided. Damage due to improper or

inadequate packing will be charged to you as an out-of-warranty cost. If our 1-800-HELP-FAX technicians determine that your unit may be an "out-of-box failure"<sup>5</sup>, we will attempt to provide you with a factory-new replacement unit<sup>6</sup>. You must ship a copy of your receipt with your original unit to verify that you purchased the unit within 10 days prior to your 1-800-HELP-FAX call.

#### **Requirements:**

You must give our technicians a valid credit card number (Discover, VISA, Master Card, or American Express/Optima). Product that is not returned to Panasonic by 10 business days after shipment of the replacement product will be charged to your credit card account at Panasonic's Suggested Retail Price (see dealer for details). If your original unit is not eligible for warranty service, your card will be charged for the non-warranty repair of the unit at Panasonic's current rate for parts and labor and for any shipping charges associated with this program. If you do not wish to pay out-of-warranty repair costs, you will be responsible for returning the replacement unit to Panasonic and for paying all shipping charges associated with this program including the UPS delivery of the replacement product to you, shipment of the problem unit to Panasonic, shipment of the replacement unit back to Panasonic and the return of your original unit back to you. Credit status will be verified prior to sending the replacement product.

1. See dealer for limited warranty details.
2. After the fax advantage program, contact our Continued Services Technical Support Line at 1-900-555-PANA (1-900-555-7262), for fee based technical support.
3. Replacement unit is refurbished.
4. Replacement program excludes Puerto Rico and is subject to termination at any time without advance notice.
5. "Out-of-box failure" is an inoperable unit that was purchased no more than 10 days prior to your 1-800-HELP-FAX call, and would otherwise qualify for warranty service under the terms and conditions of the limited warranty.
6. Panasonic reserves the right to send a refurbished unit.

**Panasonic Consumer Electronics  
Company, Division of Matsushita  
Electric Corporation of America**

One Panasonic Way,  
Secaucus, New Jersey 07094

**Panasonic Sales Company,  
Division of Matsushita Electric of  
Puerto Rico, Inc.**

Ave. 65 de Infantería, Km. 9.5  
San Gabriel Industrial Park, Carolina,  
Puerto Rico 00985

## Free Manuals Download Website

<http://myh66.com>

<http://usermanuals.us>

<http://www.somanuals.com>

<http://www.4manuals.cc>

<http://www.manual-lib.com>

<http://www.404manual.com>

<http://www.luxmanual.com>

<http://aubethermostatmanual.com>

Golf course search by state

<http://golfingnear.com>

Email search by domain

<http://emailbydomain.com>

Auto manuals search

<http://auto.somanuals.com>

TV manuals search

<http://tv.somanuals.com>