

# Panasonic

## Operating Instructions

---

Personal Facsimile

Model No. **KX-FT74HK**

Facsimile with  
Digital Answering System

Model No. **KX-FT78HK**

To get started, please read the  
Quick Start section (page 5).

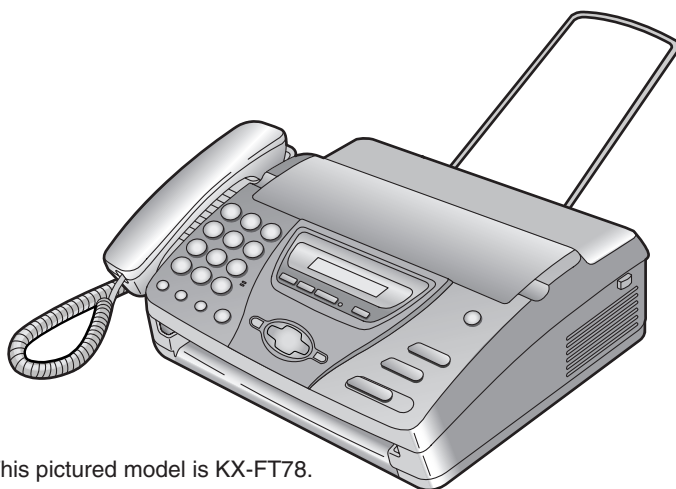

This pictured model is KX-FT78.

Please read these Operating Instructions  
before using the unit and save for future  
reference.



# Important safety instructions

When using this unit, basic safety precautions should always be followed to reduce the risk of fire, electric shock, or personal injury.

1. Read and understand all instructions.
2. Follow all warnings and instructions marked on this unit.
3. Unplug this unit from power outlets before cleaning. Do not use liquid or aerosol cleaners. Use a damp cloth for cleaning.
4. Do not use this unit near water, for example near a bathtub, wash bowl, kitchen sink, or the like.
5. Place the unit securely on a stable surface. Serious damage and/or injury may result if the unit falls.
6. Do not cover slots and openings on the unit. They are provided for ventilation and protection against overheating. Never place the unit near radiators, or in a place where proper ventilation is not provided.
7. Use only the power source marked on the unit. If you are not sure of the type of power supplied to your home, consult your dealer or local power company.
8. For safety purposes this unit is equipped with a grounded plug. If you do not have this type of outlet, please have one installed. Do not defeat this safety feature by tampering with the plug.
9. Do not place objects on the power cord. Install the unit where no one can step or trip on the cord.
10. Do not overload wall outlets and extension cords. This can result in the risk of fire or electric shock.
11. Never push any objects through slots in this unit. This may result in the risk of fire or electric shock. Never spill any liquid on the unit.
12. To reduce the risk of electric shock, do not disassemble this unit. Take the unit to an authorised service centre when service is required. Opening or

removing covers may expose you to dangerous voltage or other risks.

Incorrect reassembly can cause electric shock when the unit is subsequently used.

13. Unplug this unit from the wall outlet and refer servicing to an authorised service centre when the following conditions occur:
  - A. When the power supply cord or plug is damaged or frayed.
  - B. If liquid has been spilled into the unit.
  - C. If the unit has been exposed to rain or water.
  - D. If the unit does not work normally by following the operating instructions. Adjust only controls covered by the operating instructions. Improper adjustment may require extensive work by an authorised service centre.
  - E. If the unit has been dropped or physically damaged.
  - F. If the unit exhibits a distinct change in performance.
14. During thunderstorms, avoid using telephones except cordless types. There may be a remote risk of an electric shock from lightning.
15. Do not use this unit to report a gas leak, when in the vicinity of the leak.

## SAVE THESE INSTRUCTIONS

### CAUTION:

#### Installation

- Never install telephone wiring during a lightning storm.
- Never install telephone jacks in wet locations unless the jack is specifically designed for wet locations.

## ***Safety instructions***

---

- Never touch uninsulated telephone wires or terminals unless the telephone line has been disconnected at the network interface.
- Use caution when installing or modifying telephone lines.

### **WARNING:**

- To prevent the risk of fire or electrical shock, do not expose this product to rain or any type of moisture.

### **OTHER INFORMATION:**

- Keep the unit away from electrical noise generating devices, such as fluorescent lamps and motors.
- The unit should be kept free from dust, high temperature and vibration.
- The unit should not be exposed to direct sunlight.
- Do not place heavy objects on top of this unit.
- Do not touch the plug with wet hands.

# Connections

Only the model KX-FT74 provides "EXT" jack. To connect the extension telephone, remove the stopper.

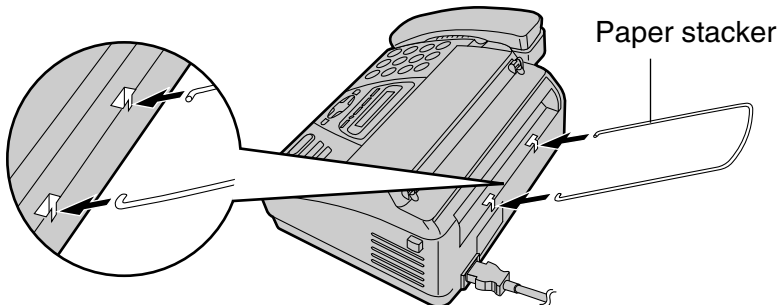
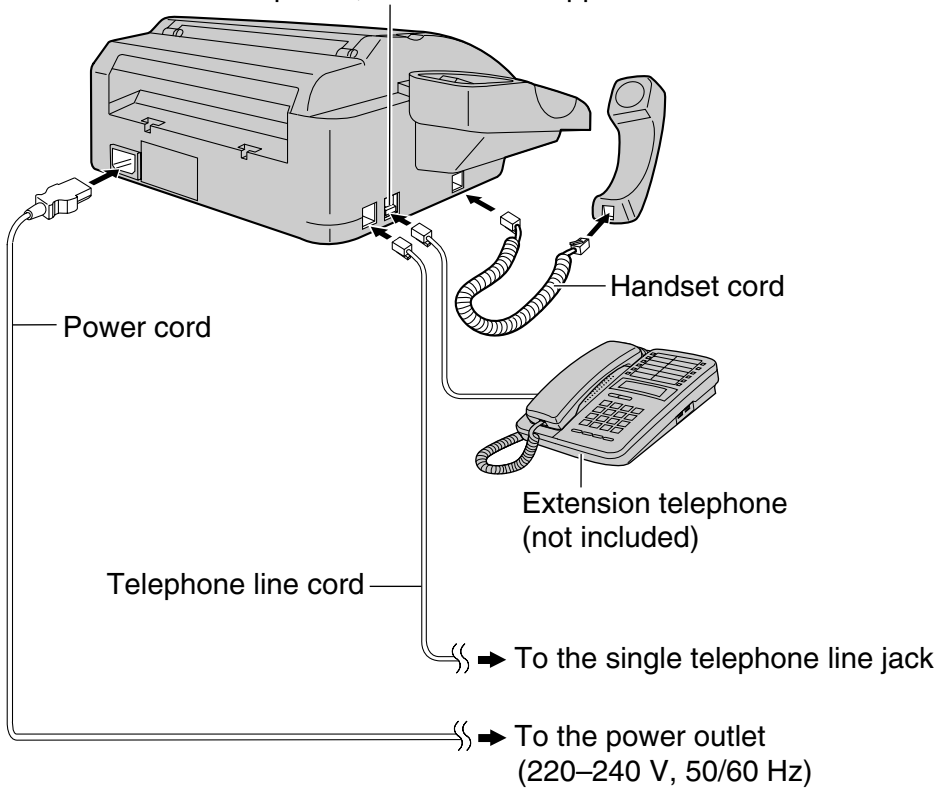

● For further details, see page 19.

# Installing the recording paper

- 1 Open the cover by pressing the cover open button and install the recording paper roll.

Correct

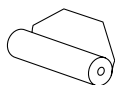

Incorrect

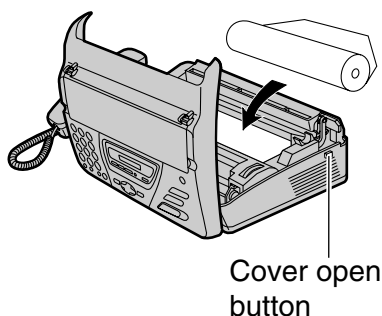
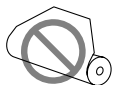

- 2 Insert the leading edge of the paper into the opening above the thermal head and pull it out of the unit.

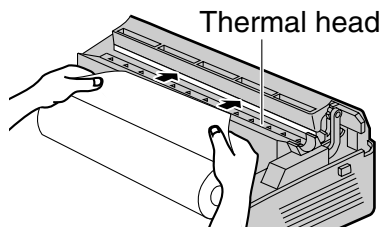

- 3 Close the cover securely by pushing down on both sides.

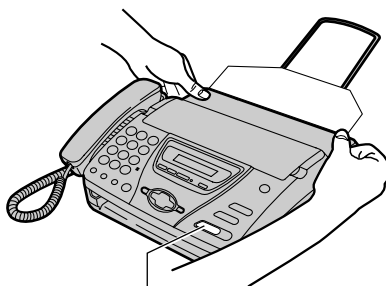

**[FAX/START]**

- 4 Press **[FAX/START]**. The unit will eject the paper slightly and cut it.

- For further details, see page 21.

## Fax – sending / Copying

**1** Open the document feeder tray.

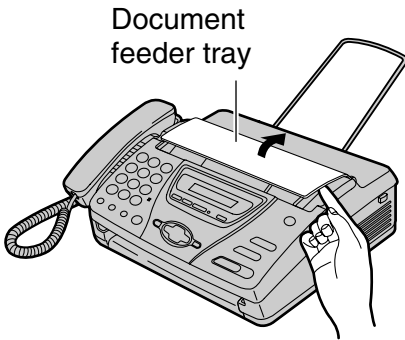

**2** Adjust the document guides, and insert the document up to 10 pages.

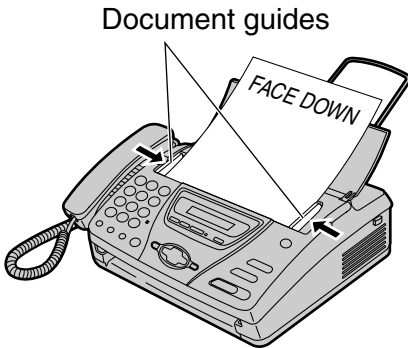

**3** To send a fax, dial the fax number and press **[FAX/START]**.  
To make a copy, press **[COPY]**.

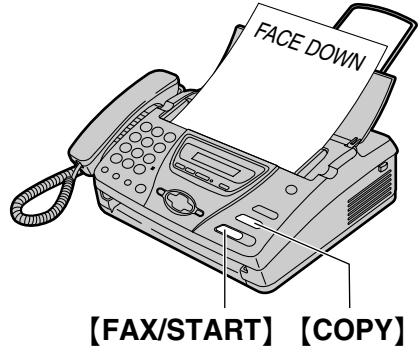

● For further details, see page 37, 56.

# Fax – receiving

- 1 When the unit rings, lift the handset.
- 2 To receive a fax document, press **[FAX/START]**.

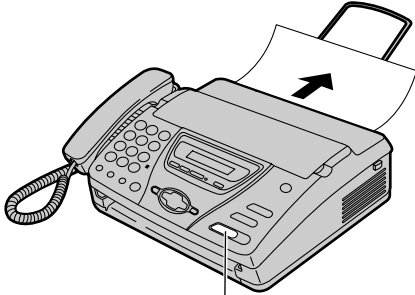

**[FAX/START]**

- For further details, see page 46.
- **You can select how you want the unit to receive calls according to your needs (page 44, 45).**



## Answering Device (KX-FT78 only)

### Recording your own greeting messages

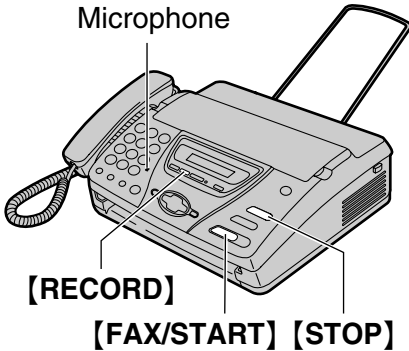

- 1** Press **[RECORD]** 2 times.
  - 2** Press **[FAX/START]**.
  - 3** Speak clearly about 20 cm away from the microphone, up to 16 seconds.
  - 4** When finished recording, press **[STOP]**.
- For further details, see page 58.

### Listening to recorded messages

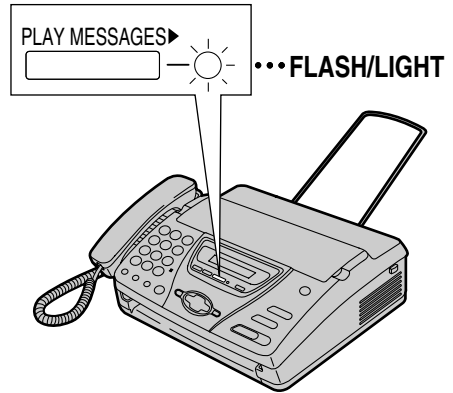

#### When the **PLAY MESSAGES** indicator flashes:

Press **[PLAY MESSAGES]**. The new recorded messages will be played.

#### When the **PLAY MESSAGES** indicator is on:

Press **[PLAY MESSAGES]**. All messages will be played.

- For further details, see page 62.

# Table of Contents

---

---

## Initial Preparation

|                             |   |
|-----------------------------|---|
| <b>Accessories</b>          | Included accessories ..... 13                     |
|                             | Accessory information ..... 13                    |
| <b>Help Button</b>          | Help function ..... 14                            |
| <b>Finding the Controls</b> | Location of controls ..... 15                     |
| <b>Setup</b>                | Connections ..... 19                              |
|                             | Recording paper – installing / replacing ..... 21 |
|                             | Date and time, your logo and fax number ..... 22  |
| <b>Volume</b>               | Adjusting volume ..... 26                         |

---

## Telephone

|                            |   |
|----------------------------|---|
| <b>Navigator Directory</b> | Storing names and telephone numbers into the directory ..... 27         |
|                            | Editing a stored entry ..... 29   |
|                            | Erasing a stored entry ..... 30   |
|                            | Making a phone call using the directory ..... 31                        |
| <b>Recording</b>           | Recording a telephone conversation (KX-FT78 only) ..... 32              |
| <b>Caller ID</b>           | Caller ID service from your phone company ..... 33                      |
| <b>Dial Lock</b>           | Setting the dial lock ..... 34  |
| <b>Voice Contact</b>       | Talking to the other party after fax transmission or reception ..... 36 |

---

## Fax

|                        |  |
|------------------------|--|
| <b>Sending Faxes</b>   | Sending a fax manually ..... 37  |
|                        | Documents you can send ..... 39  |
|                        | Sending a fax using the directory ..... 40   |
|                        | Broadcast transmission (KX-FT78 only) ..... 41   |
|                        | Transmit polling (letting another machine retrieve a fax on your unit) ..... 43                |
| <b>Receiving Faxes</b> | Setting the unit to receive faxes ..... 44   |
|                        | TEL mode (answering all calls manually) ..... 46   |
|                        | FAX ONLY mode (all calls are received as faxes) ..... 47                                       |
|                        | TEL/FAX mode (receiving phone calls with ring signals and faxes without ring signals) ..... 48 |
|                        | Extension telephone ..... 51   |

---

|  |    |
|--|----|
| Receive polling (retrieving a fax placed on another fax machine) ..... | 52 |
| Black list function .....  | 53 |
| Pager call .....   | 54 |

---

|                    |   |    |
|--------------------|---|----|
| <b>Duplex Ring</b> | Using with the ring detection feature ..... | 55 |
|--------------------|---|----|

---

## Copy

---

|                |                     |    |
|----------------|---------------------|----|
| <b>Copying</b> | Making a copy ..... | 56 |
|----------------|---------------------|----|

---

## Answering Device (KX-FT78 only)

---

|                             |  |    |
|-----------------------------|--|----|
| <b>Setup (KX-FT78 only)</b> | TAD/FAX mode (receiving phone calls and faxes automatically) ..... | 57 |
|-----------------------------|--|----|

---

---

|                                |   |    |
|--------------------------------|---|----|
| <b>Greeting (KX-FT78 only)</b> | Recording your own greeting messages .....        | 58 |
|                                | Erasing your own recorded greeting messages ..... | 60 |

---

---

|                                    |  |    |
|------------------------------------|--|----|
| <b>Memo Message (KX-FT78 only)</b> | Leaving a message for others or yourself ..... | 61 |
|------------------------------------|--|----|

---

---

|   |                                      |    |
|---|--------------------------------------|----|
| <b>Incoming Messages (KX-FT78 only)</b> | Listening to recorded messages ..... | 62 |
|---|--------------------------------------|----|

---

---

|  |  |    |
|--|--|----|
| <b>Remote Operation (KX-FT78 only)</b> | Operating from a remote location ..... | 64 |
|--|--|----|

---

---

|                              |   |    |
|------------------------------|---|----|
| <b>Option (KX-FT78 only)</b> | Transferring recorded messages to another telephone ... | 67 |
|------------------------------|---|----|

---

## Programmable Features

---

|                         |                         |    |
|-------------------------|-------------------------|----|
| <b>Features Summary</b> | Programming .....       | 69 |
|                         | Basic features .....    | 70 |
|                         | Advanced features ..... | 72 |

---

## Help

---

|                       |               |    |
|-----------------------|---------------|----|
| <b>Error Messages</b> | Reports ..... | 76 |
|                       | Display ..... | 77 |

---

---

|                                   |   |    |
|-----------------------------------|---|----|
| <b>Frequently Asked Questions</b> | When a function does not work, check here ..... | 79 |
|-----------------------------------|---|----|

---

---

|             |                               |    |
|-------------|-------------------------------|----|
| <b>Jams</b> | Document jams – sending ..... | 82 |
|             | Recording paper jam .....     | 83 |

---

---

|                 |                                   |    |
|-----------------|-----------------------------------|----|
| <b>Cleaning</b> | Document feeder .....             | 84 |
|                 | Thermal head and head cover ..... | 86 |

---

# ***Table of Contents***

---

---

## **General Information**

---

|                        |  |    |
|------------------------|--|----|
| <b>Printed Reports</b> | Reference lists and reports .....      | 88 |
| <b>Specifications</b>  | Technical data about this product..... | 89 |





---

## **Index**

---

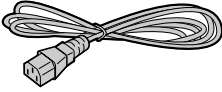
|              |                     |    |
|--------------|---------------------|----|
| <b>Index</b> | Program index ..... | 91 |
|              | Index .....         | 92 |

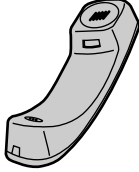
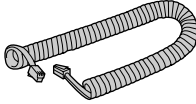
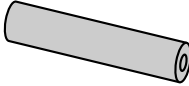
## Included accessories

|  |   |   |
|--|---|---|
| Power cord..... 1<br>             | Telephone line cord..... 1<br> | Handset..... 1<br>       |
| Handset cord ..... 1<br>          | Recording paper ..... 1<br>    | Paper staker ..... 1<br> |
| Operating instructions..... 1<br> |   |   |

- If any items are missing or damaged, check with the place of purchase.
- Save the original carton and packing materials for future shipping and transportation of the unit.

## Accessory information

Use the following type of paper for replacement.

| Model No. | Item                             | Specifications                      |
|-----------|----------------------------------|-------------------------------------|
| KX-A106   | Standard thermal recording paper | 216 mm × 30 m roll, with 25 mm core |

# Help Button

## Help function

You can print a quick reference for assistance as follows.

### For KX-FT74

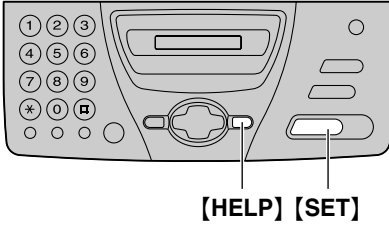

**1** Press **[HELP]** repeatedly until the desired item is displayed.

1. How to program your unit.

HOW TO SET UP

2. How to store names in the directory and how to dial them.

DIRECTORY

3. Explanation of the receiving modes.

RECEIVE MODE

**2** Press **[SET]**.

PRINTING

### For KX-FT78

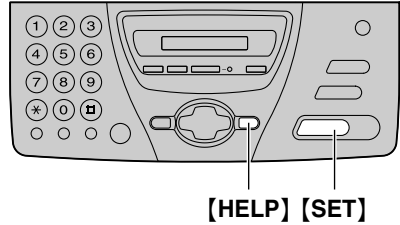

**1** Press **[HELP]** repeatedly until the desired item is displayed.

1. How to program your unit.

HOW TO SET UP

2. How to store names in the directory and how to dial them.

DIRECTORY

3. Explanation of the receiving modes.

RECEIVE MODE

4. Help with problems operating the answering device.

TAD OPERATION

**2** Press **[SET]**.

PRINTING

## Location of controls

### For KX-FT74

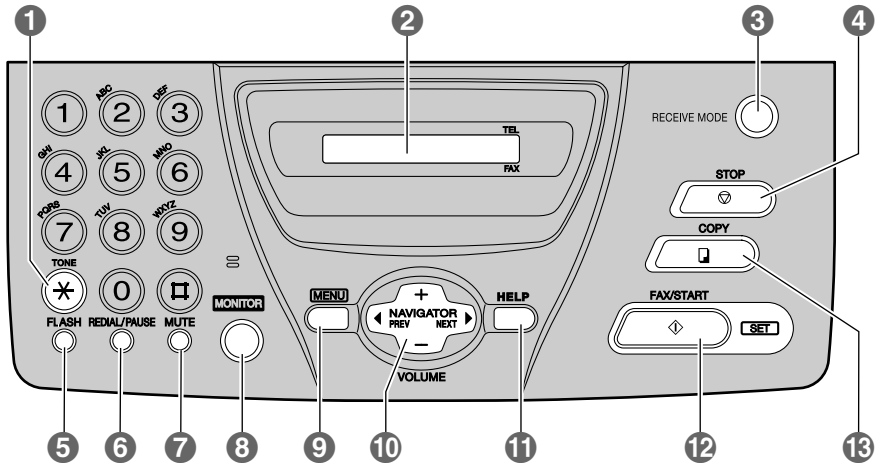

#### 1 [TONE]

- To change from pulse to tone temporarily during dialling when your line has rotary pulse services.

#### 2 Display

#### 3 [RECEIVE MODE]

- To change the receiving mode (page 44, 45).

#### 4 [STOP]

- To stop an operation or cancel programming.

#### 5 [FLASH]

- To access special telephone services such as call waiting or for transferring extension calls.

#### 6 [REDIAL/PAUSE]

- To redial the last number dialled. If the line is busy when you make a phone call using the **[MONITOR]** button, the unit will automatically redial the number up to 5 times.
- To insert a pause during dialling.

#### 7 [MUTE]

- To mute your voice to the other party during a conversation. Press this button again to resume the conversation.

#### 8 [MONITOR]

- To dial without lifting the handset.

#### 9 [MENU]

- To initiate or exit programming.

#### 10 [NAVIGATOR, VOLUME]

- To adjust volume (page 26).
- To search for a stored name (page 31, 40).
- To select the features or feature settings during programming (page 69).
- To navigate to the next operation.

#### 11 [HELP]

- To print a quick reference (page 14).

## ***Finding the Controls***

---

### **12 [FAX/START, SET]**

- To initiate fax transmission or reception.
- To store a setting during programming.

### **13 [COPY]**

- To initiate copying (page 56).



## For KX-FT78

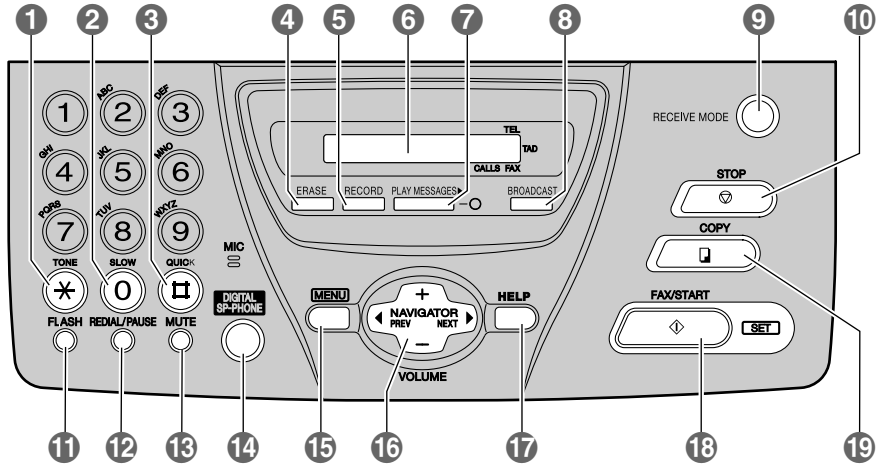

- 1 [TONE]**
  - To change from pulse to tone temporarily during dialling when your line has rotary pulse services.
- 2 [SLOW]**
  - For slow playback (page 62).
- 3 [QUICK]**
  - For quick playback (page 62).
- 4 [ERASE]**
  - To erase recorded messages (page 60, 63).
- 5 [RECORD]**
  - To record your messages (page 32, 58, 61).
- 6 Display**
- 7 [PLAY MESSAGES]**
  - To play recorded messages (page 62).
- 8 [BROADCAST]**
  - To transmit to multiple entries (page 41).
- 9 [RECEIVE MODE]**
  - To change the receiving mode (page 44, 45).
- 10 [STOP]**
  - To stop an operation or cancel programming.
- 11 [FLASH]**
  - To access special telephone services such as call waiting or for transferring extension calls.
- 12 [REDIAL/PAUSE]**
  - To redial the last number dialled. If the line is busy when you make a phone call using the **[DIGITAL SP-PHONE]** button, the unit will automatically redial the number up to 5 times.
  - To insert a pause during dialling.
- 13 [MUTE]**
  - To mute your voice to the other party during a conversation. Press this button again to resume the conversation.
- 14 [DIGITAL SP-PHONE]**
  - For speakerphone operation. To switch to the handset, lift the handset. To switch back to the speakerphone, press **[DIGITAL SP-PHONE]**.

# Finding the Controls

---

## 15 [MENU]

- To initiate or exit programming.

## 16 [NAVIGATOR, VOLUME]

- To adjust volume (page 26).
- To search for a stored name (page 31, 40).
- To select the features or feature settings during programming (page 69).
- To navigate to the next operation.

## 17 [HELP]

- To print a quick reference (page 14).

## 18 [FAX/START, SET]

- To initiate fax transmission or reception.
- To store a setting during programming.

## 19 [COPY]

- To initiate copying (page 56).

## Overview

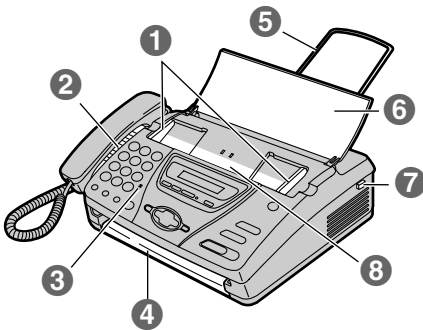

## 1 Document guides

## 2 Speaker

## 3 Microphone (KX-FT78 only)

- To talk with the other party when using the speakerphone.

## 4 Document exit

## 5 Paper stacker

## 6 Document feeder tray

## 7 Cover open button

## 8 Document entrance

\* The pictured model is KX-FT78.

## Connections

- 1** Connect the handset cord, the telephone line cord and the power cord.

Only the model KX-FT74 provides "EXT" jack.  
To connect the extension telephone, remove  
the stopper.

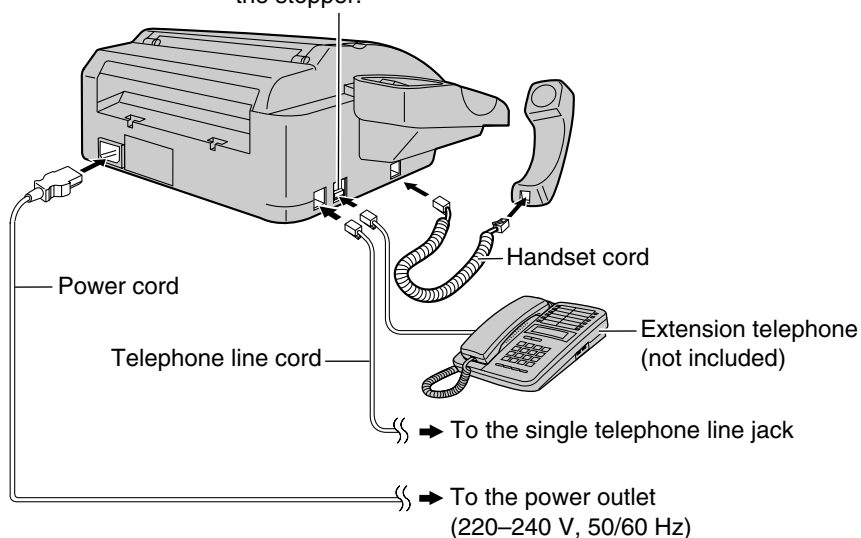

- 2** Install the paper stacker.

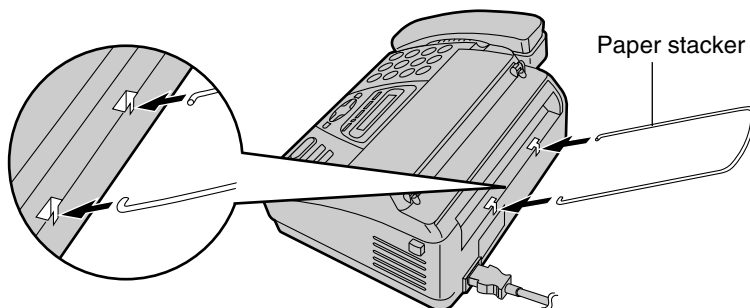

### Caution:

- When you operate this product, the power outlet should be near the product and easily accessible.
- Use the telephone line cord included in this unit.
- Do not extend the telephone line cord.

# Setup

---

**Note:**

- An earthed contact socket should be used when connecting the unit to the power outlet.
- 

**To use the fax machine with a computer on the same line**

- We recommend you use separate wall jacks for the fax machine and the computer.
- Set the fax machine to TEL mode (page 46).
- The device which has the shortest ring setting will answer the call first.
- If the computer provides a port for a telephone line, connect the fax machine to this port on the computer.

## Recording paper – installing / replacing

For replacement, remove the used core after opening the cover.

- 1 Open the cover by pressing the cover open button and install the recording paper roll.

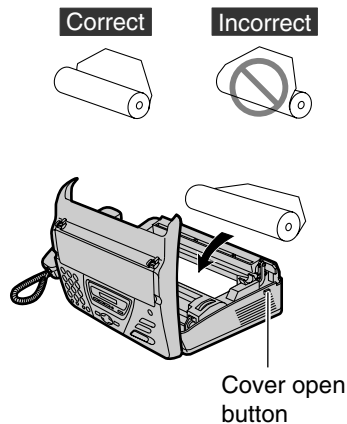

- If the paper is secured with glue or tape, cut approximately 15 cm from the beginning of the roll.

- 2 Insert the leading edge of the paper into the opening above the thermal head and pull it out of the unit.

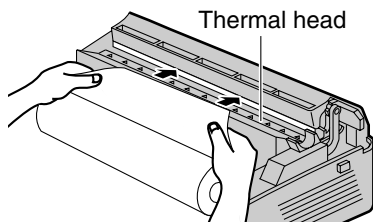

- Make sure that there is no slack in the paper roll.

- 3 Close the cover securely by pushing down on both sides.

PRESS START

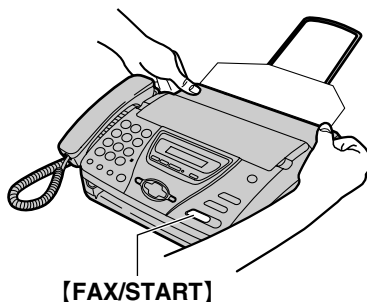

- 4 Press **[FAX/START]**.
  - The unit will eject the paper slightly and cut it.
  - If you do not press **[FAX/START]** within 30 seconds, the unit will automatically eject the paper slightly and cut it.

### Note:

- Only use the included roll of paper or specified recording paper, or else the print quality may be affected and/or excessive thermal head wear may occur.
- For accessory information, see page 13.
- When the power cord is connected, every time you close the cover a message will be printed. If the recording paper is set to the wrong side, a message will not be printed. Install the paper correctly.

## Setup

# Date and time, your logo and fax number

You should program the date and time, your logo and fax number.

This information will be printed on each page transmitted from your unit.

## Setting the date and time

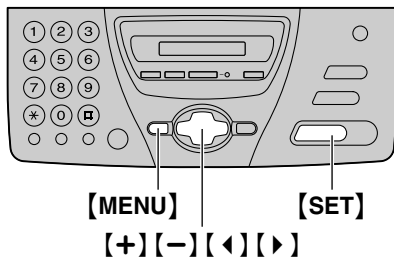

**1** Press **[MENU]**.

SYSTEM SET UP

**2** Press **[SET]**.

PRESS [◀] & [SET]

**3** Press **[◀]** or **[▶]** until the following is displayed.

SET DATE & TIME

**4** Press **[SET]**.

Example: M: 01/D: 01/Y: 02

- The underbar shows a position of the cursor.

**5** Enter the correct month/day/year by selecting 2 digits for each, using the dial keypad.

**Example: August 10, 2002**

Press **[0][8] [1][0] [0][2]**.

M: 08/D: 10/Y: 02

**6** Press **[SET]**.

Example: TIME: 12 : 00AM

**7** Enter the correct hour/minute by selecting 2 digits for each, using the dial keypad. Press **[\*]** to select "AM" or "PM".

**Example: 3:15 PM**

**1.** Press **[0][3] [1][5]**.

TIME: 03 : 15AM

**2.** Press **[\*]** until "PM" is displayed.

TIME: 03 : 15PM

**8** Press **[SET]**.

- The next feature will be displayed.

**9** Press **[MENU]**.

### Note:

- You can enter the number by pressing **[+]** or **[-]** in steps 5 and 7. In this case, press **[▶]** to move the cursor.
- The accuracy of the clock is approximately  $\pm 60$  seconds a month.

### To correct a mistake

Press **[◀]** or **[▶]** to move the cursor to the incorrect number, and make the correction.

## Setting your logo

The logo can be your company, division or name.

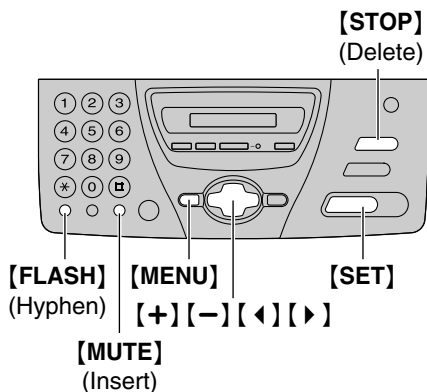

**1** Press **[MENU]**.

SYSTEM SET UP

**2** Press **[SET]**.

PRESS [◀] & [SET]

**3** Press **[◀]** or **[▶]** until the following is displayed.

YOUR LOGO

**4** Press **[SET]**.

LOGO=

**5** Enter your logo, up to 30 characters, using the dial keypad. See page 24 for details.

**Example: "Bill"**

**1.** Press **[2]** 2 times.

LOGO=B

- The underbar shows a position of the cursor.

**2.** Press **[4]** 6 times.

LOGO=Bi

**3.** Press **[5]** 6 times.

LOGO=Bi

**4.** Press **[▶]** to move the cursor to the next space and press **[5]** 6 times.

LOGO=Bill

**6** Press **[SET]**.

- The next feature will be displayed.

**7** Press **[MENU]**.

**Note:**

- You can enter your logo by pressing **[+]** or **[-]** in step 5. In this case, press **[▶]** to move the cursor (see page 24 for details).

### To correct a mistake

Press **[◀]** or **[▶]** to move the cursor to the incorrect character, and make the correction.

### To delete a character

Press **[◀]** or **[▶]** to move the cursor to the character you want to delete and press **[STOP]**.

### To insert a character

- 1.** Press **[◀]** or **[▶]** to move the cursor to the position to the right of where you want to insert the character.
- 2.** Press **[MUTE]** to insert a space and enter the character.

# Setup

## To select characters with the dial keypad

Pressing the dial keys will select a character as shown below.

| Keys           | Characters   |
|----------------|--|
| <b>[1]</b>     | 1 [ ] { } + - / = , . _ ` : ; ?  |
| <b>[2]</b>     | A B C a b c 2  |
| <b>[3]</b>     | D E F d e f 3  |
| <b>[4]</b>     | G H I g h i 4  |
| <b>[5]</b>     | J K L j k l 5  |
| <b>[6]</b>     | M N O m n o 6  |
| <b>[7]</b>     | P Q R S p q r s 7  |
| <b>[8]</b>     | T U V t u v 8  |
| <b>[9]</b>     | W X Y Z w x y z 9  |
| <b>[0]</b>     | 0 ( ) < > ! " # \$ % & ¥ * @ ^ ' →   |
| <b>[FLASH]</b> | <b>Hyphen</b> button (To insert a hyphen.)   |
| <b>[MUTE]</b>  | <b>Insert</b> button (To insert one character or one space.)   |
| <b>[STOP]</b>  | <b>Delete</b> button (To delete a character.)  |
| <b>[▶]</b>     | The cursor is moved to the right. To enter another character using the same number key, move the cursor to the next space. |
| <b>[◀]</b>     | The cursor is moved to the left.   |

## To select characters using **[+]** or **[-]**

Instead of pressing the dial keys, you can select characters using **[+]** or **[-]**.

1. Press **[+]** or **[-]** until the desired character is displayed.
2. Press **[▶]** to move the cursor to the next space.
  - The character displayed in step 1 is inserted.
3. Return to step 1 to enter the next character.

## Display order of characters

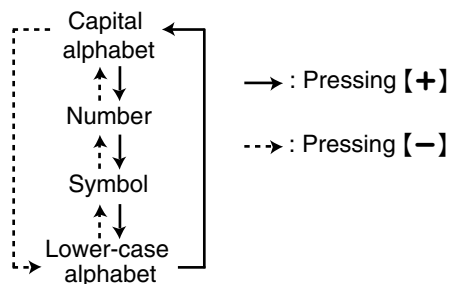



## Setting your fax number

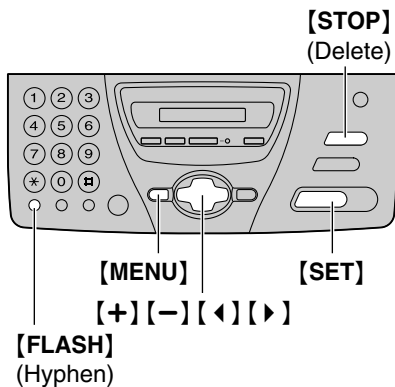

### Note:

- You can enter your fax telephone number by pressing **[+]** or **[-]** in step 5. In this case, press **[▶]** to move the cursor.
- The **[\*]** button replaces the digit with a “+” and the **[#]** button replaces it with a space.  
**Example: +234 5678**  
 Press **[\*][2][3][4][#][5][6][7][8]**.
- To enter a hyphen in a fax number, press **[FLASH]**.

**1** Press **[MENU]**.

SYSTEM SET UP

**2** Press **[SET]**.

PRESS [◀▶] & [SET]

**3** Press **[◀]** or **[▶]** until the following is displayed.

YOUR FAX NO.

**4** Press **[SET]**.

NO. =

**5** Enter your fax number, up to 20 digits, using the dial keypad.

Example: NO. =1234567

**6** Press **[SET]**.

- The next feature will be displayed.

**7** Press **[MENU]**.

### To correct a mistake

Press **[◀]** or **[▶]** to move the cursor to the incorrect number, and make the correction.

### To delete a number

Press **[◀]** or **[▶]** to move the cursor to the number you want to delete and press **[STOP]**.

## Adjusting volume

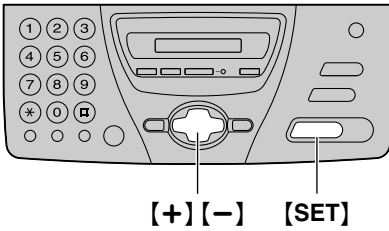

### Ringer volume

4 levels (high/middle/low/off) are available. While the unit is idle, press **[+]** or **[-]**.

- If any documents are in the document entrance, you cannot adjust the ringer volume. Confirm that there are no documents in the entrance.

#### To turn the ringer off

1. Press **[-]** repeatedly until the following is displayed.

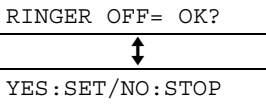

2. Press **[SET]**.

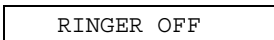

- To turn the ringer back on, press **[+]**.

#### While the ringer volume is set to off

When a call is received, the unit will not ring and will display the following.

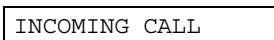

### Handset receiver volume

3 levels (high/middle/low) are available. While using the handset, press **[+]** or **[-]**.

### Monitor/Speaker volume

8 levels (high to low) are available. While using the monitor/speakerphone, press **[+]** or **[-]**.

### Voice guidance volume (KX-FT78 only)

9 levels (high to off) are available. While listening to the voice guidance, press **[+]** or **[-]**.

### Answering device volume (KX-FT78 only)

9 levels (high to off) are available. While listening to the recorded messages, press **[+]** or **[-]**.

## Storing names and telephone numbers into the directory

For rapid access to frequently dialed numbers, the unit provides the navigator directory (50 entries).

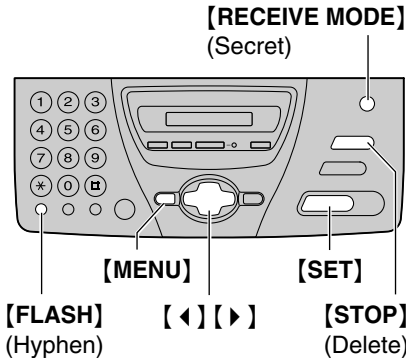

- 1 Press **[MENU]** repeatedly until the following is displayed.

DIRECTORY SET

- 2 Press **[SET]**.

NAME=

- 3 Enter the name, up to 10 characters (see page 24 for instructions).

Example: NAME=Alice

- 4 Press **[SET]**.

NO. =

- 5 Enter the telephone number, up to 30 digits, using the dial keypad.

Example: NO. =5552233

- If you want to enter a hyphen, press **[FLASH]**.

- 6 Press **[SET]**.

REGISTERED

NAME=

- To program other entries, repeat steps 3 to 6.

- 7 Press **[MENU]** to exit the program.

### Helpful hint:

- You can confirm the stored entries on the display (page 31) or on the telephone number list (page 88).

### Note:

- When the following is displayed in step 6, you can store only 5 more entries.

SPACE= 5 DIRS.

- If there is no space to store new entries, the following is displayed in step 6. Erase unnecessary entries (page 30).

DIRECTORY FULL

- A hyphen or a space entered in a telephone number counts as two digits.

---

## To correct a mistake

Press [◀] or [▶] to move the cursor to the incorrect character/number, and make the correction.

---

## To delete a character/number

Press [◀] or [▶] to move the cursor to the character/number you want to delete, and press **[STOP]**.

---

## To keep the telephone number secret

Press **[RECEIVE MODE]** after entering the telephone number in step 5.

- A secret number cannot be viewed after this is set.
- The telephone number will not appear on the telephone number list.

## Editing a stored entry

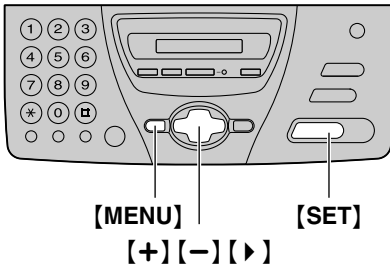

**1** Press [(▶)].

DIRECTORY [±]

**2** Press [(+)] or [(-)] until the desired name is displayed.

Example: Mary [±]

**3** Press [MENU].

EDIT=\* DELETE=#

**4** Press [(\*)].

Example: NAME=Mary

- If you do not need to edit the name, skip to step 6.

**5** Edit the name (see page 24 for instructions).

**6** Press [SET].

Example: NO.=0123456

- If you do not need to edit the telephone number, skip to step 8.

**7** Edit the telephone number. For further details, see page 27, 28.

**8** Press [SET].

REGISTERED

## Erasing a stored entry

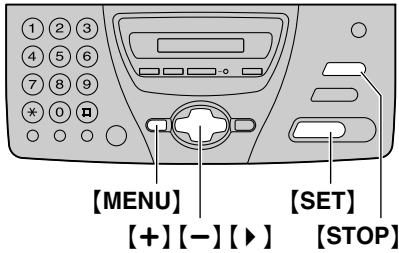

**1** Press [▶].

DIRECTORY [±]

**2** Press [+] or [-] until the desired name is displayed.

Example: Peter [±]

**3** Press [MENU].

EDIT=\* DELETE=#

**4** Press [⏏].

DELETE OK?



YES : SET / NO : STOP

- To cancel erasing, press [STOP].

**5** Press [SET].

DELETED

- The stored name and number are erased.

## Making a phone call using the directory

Before using this feature, program the desired names and telephone numbers into the directory (page 27).

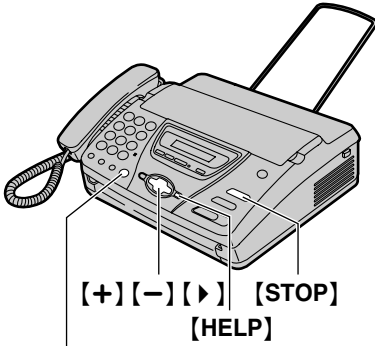

[MONITOR] (KX-FT74)  
[DIGITAL SP-PHONE] (KX-FT78)

- 1 Press [▶].

DIRECTORY [±]

- 2 Press [+] or [-] until the desired name is displayed.

Example: Lisa [±]

- If the desired name has not been stored, press [STOP] and dial the number manually.

- 3 Press [MONITOR] (KX-FT74)/[DIGITAL SP-PHONE] (KX-FT78) or lift the handset.
  - The unit will start dialling automatically.

### To confirm the stored telephone number on the display

1. Press [▶].
2. Press [+] or [-] until the desired name is displayed.
3. Press [HELP].
  - To stop the operation, press [STOP].
  - To make a call, press [MONITOR]/[DIGITAL SP-PHONE] or lift the handset.

### To search for a name by initial

Example: "Lisa"

1. Press [▶].
2. Press [+] or [-] to enter the directory.
3. Press [5] repeatedly until any name with the initial "L" is displayed (see the character table on page 24).
  - To search for symbols (not letters or numbers), press [✱].
4. Press [+] until "Lisa" is displayed.
  - To stop the search, press [STOP].
  - To make a call, press [MONITOR]/[DIGITAL SP-PHONE] or lift the handset.

## Recording

---

# Recording a telephone conversation (KX-FT78 only)

You can record a telephone conversation. This conversation can be played back later, either directly or remotely (page 62, 64).

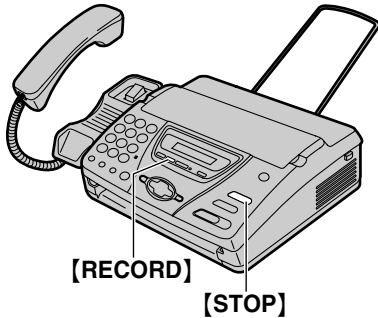

- 1 During a telephone conversation, press **[RECORD]**.

2WAY RECORDING

- 2 To stop recording, press **[STOP]** or replace the handset.

### Note:

- There may be legal restrictions on recording two-way telephone conversations. Inform the other party that the conversation is being recorded.



## Caller ID service from your phone company

This unit is compatible with the Caller ID service offered by your local telephone company. To use this feature, you must subscribe to a Caller ID service.

### Important:

- This unit will only display the caller's telephone number or name.
- This unit will not support future additional telephone services.
- This unit cannot support services based on the "DTMF based subscriber line protocol".
- Depending on the service of the local telephone company, the date/time of the call or caller's name may not be displayed.

### Change the following ring settings to 2 or more rings beforehand.

- TAD ring setting (feature #06 on page 70) (KX-FT78 only)
- FAX ring setting (feature #07 on page 70)
- TEL/FAX ring setting (feature #09 on page 70)

## How Caller ID is displayed

The calling party's telephone number or name will be displayed after the first ring. You then have the option of whether or not to answer the call depending on the caller. The unit will automatically store the caller information (telephone number, name and the time of the call). You can print the caller ID list.

### Note:

- If the name display service is not offered by your local telephone company, only the telephone number will be displayed.

## To confirm caller information using the Caller ID list

The unit will store information for the most recent 20 callers.

- To print manually, see page 88.
- To print automatically after every 20 new calls, activate feature #26 (page 72).

## Setting the dial lock

The dial lock feature prevents the unit from calls being made to any numbers, except for pre-stored emergency telephone numbers (up to 3).

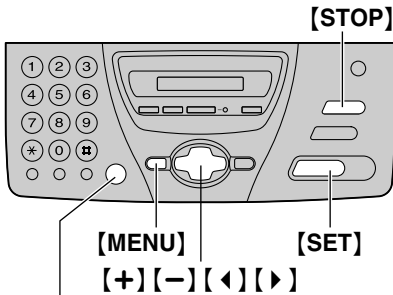

**[MONITOR]** (KX-FT74)  
**[DIGITAL SP-PHONE]** (KX-FT78)

- 1 Press **[MENU]** repeatedly until the following is displayed.

DIAL LOCK

- 2 Press **[SET]**.

CODE=

- 3 Enter your PIN (Personal Identification Number) code, from 2 to 4 digits, using 0–9.

- Please note your PIN code. If you forget your PIN code, consult your nearest Panasonic service centre.

- 4 Press **[SET]**.

E01=

- 5 Enter an emergency telephone number, up to 30 digits, using the dial keypad.

- 6 Press **[SET]**.

E02=

- 7 If necessary, enter the second emergency telephone number.
  - If you do not need to enter, skip to step 8.

- 8 Press **[SET]**.

E03=

- 9 If necessary, enter the third emergency telephone number.
  - If you do not need to enter, skip to step 10.

- 10 Press **[SET]**.

DIAL LOCK

### Note:

- You can also enter an emergency telephone number using the directory in steps 5, 7 and 9. Press **[+]** or **[-]** until the desired name is displayed, then press **[SET]**.

### To correct an emergency telephone number

- Press **[◀]** or **[▶]** to move the cursor to the incorrect number, and make the correction.
- To delete a number, move the cursor to the number you want to delete, and press **[STOP]**.

## Making an emergency call

1. Press **[MONITOR]** (KX-FT74)/  
**[DIGITAL SP-PHONE]** (KX-FT78) or lift  
the handset while the unit displays the  
following.

DIAL LOCK

- The display will show the following.

Example: E01=0123456 [±]

2. Press **[+]** or **[-]** until the desired  
emergency telephone number is  
displayed.

Example: E03=6543210 [±]

3. Press **[SET]**.

- The unit will start dialling  
automatically.
- If any documents are in the document  
entrance, the unit will start fax  
transmission.

---

## To cancel the dial lock

1. Press **[MENU]** repeatedly until the  
following is displayed.

DIAL LOCK

2. Press **[SET]**.
3. Enter your PIN code.
4. Press **[SET]**.

# Talking to the other party after fax transmission or reception

You can talk to the other party after a fax message is completed. This will save the added expense and time of making another call.

### Important:

- This feature only works when the other party's fax machine is equipped with a voice contact feature.

## Initiating voice contact

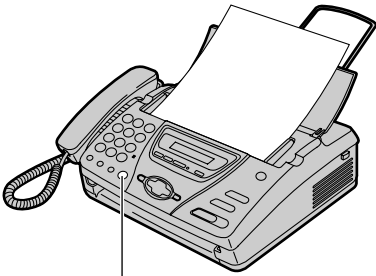

**[MONITOR]** (KX-FT74)  
**[DIGITAL SP-PHONE]** (KX-FT78)

- 1 Press **[MONITOR]** (KX-FT74)/**[DIGITAL SP-PHONE]** (KX-FT78) while transmitting or receiving documents.

VOICE STANDBY

- Your unit will call the other party with a distinctive ring.
- When the other party answers, your unit will emit a distinctive ring.

- 2 Press **[DIGITAL SP-PHONE]** (KX-FT78) or lift the handset to start talking.

### Note:

- If you initiate voice contact during transmission and the other party answers, the unit will call you with a distinctive ring after all of the documents have been transmitted.
- If you initiate voice contact during reception and the other party answers, the unit will call you with a distinctive ring after the current page of the document has been received.

## Receiving a request for voice contact

- 1 If the other party initiates voice contact, your unit will sound a distinctive ring and the following will be displayed.

PLEASE PICK UP

- 2 Press **[DIGITAL SP-PHONE]** (KX-FT78) or lift the handset within 10 seconds of the distinctive ring to start talking.

### Note:

- If you do not answer within 10 seconds of the distinctive ring:
  - In TAD/FAX mode, your unit will play a greeting message and record an incoming voice message (KX-FT78 only).
  - In FAX ONLY, TEL or TEL/FAX mode, the line will be disconnected.

## Sending a fax manually

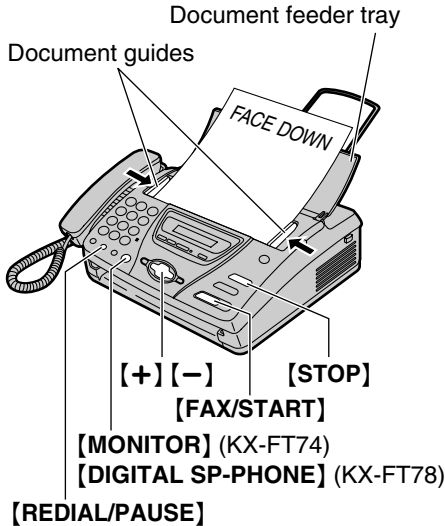

- 1** Open the document feeder tray.
- 2** Adjust the width of the document guides to the size of the document.
- 3** Insert the document (up to 10 pages) FACE DOWN until the unit grasps the document and a single beep is heard.

STANDARD [±]

- 4** If necessary, press **[+]** or **[-]** repeatedly to select the desired resolution.
- 5** Press **[MONITOR]** (KX-FT74)/**[DIGITAL SP-PHONE]** (KX-FT78) or lift the handset.

TEL=

- 6** Dial the fax number.

- 7** Start sending.

### When a fax tone is heard:

Press **[FAX/START]**, and replace the handset if you are using it.

### When the other party answers your call:

Ask them to press their start button. When the fax tone is heard, press **[FAX/START]** and replace the handset if you are using it.

CONNECTING . . . .

### To redial the last number

Press **[REDIAL/PAUSE]**.

- If the line is busy, the unit will automatically redial the number up to 5 times.
- During redial, the following will be displayed.

WAITING REDIAL

- To cancel redialling, press **[STOP]**.

### To select the resolution

Select the desired resolution according to the type of document.

- **"STANDARD"**: For printed or typewritten originals with normal-sized characters.
- **"FINE"**: For originals with small printing.
- **"SUPER FINE"**: For originals with very small printing. This setting only works with other compatible fax machines.
- **"PHOTO"**: For originals containing photographs, shaded drawings, etc.
- Using the "FINE", "SUPER FINE" or "PHOTO" setting will increase transmission time.
- If the resolution setting is changed during feeding, it will be effective from the next sheet.

# ***Sending Faxes***

---

---

## **To transmit more than 10 pages at a time**

Insert the first 10 pages of the document. Add the other pages (up to 10 at a time) before the last page feeds into the unit.

---

## **To stop transmission**

Press **[STOP]**.

- To eject the document, press **[STOP]** again.

---

## **Sending report for confirmation**

This report will provide you with a printed record of transmission results. To use this feature, activate feature #04 (page 70). For the communication message in the result column, see page 76.

---

## **Journal report**

The unit stores the 35 most recent fax communication results. To print manually, see page 88. To print automatically after every 35 new fax communications, activate feature #22 (page 72). For the communication message in the result column, see page 76.

## Documents you can send

### Minimum size

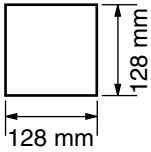

### Maximum size

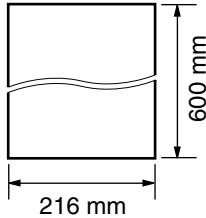

### Effective scanning area

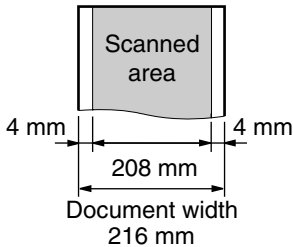

### Document weight

- Single sheet: 45 g/m<sup>2</sup> to 90 g/m<sup>2</sup>
- Multiple sheets: 60 g/m<sup>2</sup> to 75 g/m<sup>2</sup>

### Note:

- Remove clips, staples or other similar fasteners.
- Check that ink, paste or correction fluid has dried.
- Do not send the following types of documents: (Use copies for fax transmission.)
  - Chemically treated paper such as carbon or carbonless duplicating paper
  - Electrostatically charged paper
  - Badly curled, creased or torn paper
  - Paper with a coated surface
  - Paper with a faint image
  - Paper with printing on the opposite side that can be seen through the front (i.e. newspaper)
- To transmit the document with a width of less than A4 size (210 mm), we recommend using a copy machine to copy the original document onto A4 or letter-sized paper, then transmitting the copied document.

## Sending a fax using the directory

Before using this feature, program the desired names and telephone numbers into the directory (page 27).

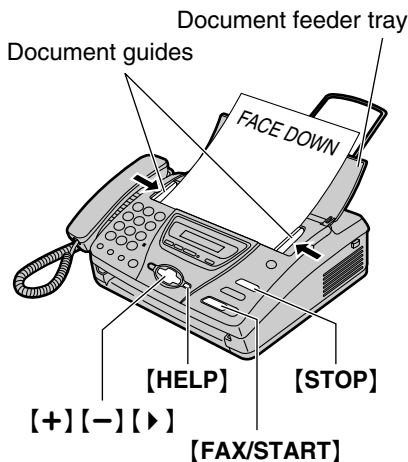

- 1 Open the document feeder tray.
- 2 Adjust the width of the document guides to the size of the document.
- 3 Insert the document (up to 10 pages) FACE DOWN until the unit grasps the document and a single beep is heard.

STANDARD [±]

- 4 If necessary, press **[+]** or **[-]** repeatedly to select the desired resolution (page 37).
- 5 Press **[▶]**.

DIRECTORY [±]

- 6 Press **[+]** or **[-]** until the desired name is displayed.

Example: Sam [±]

- To confirm the telephone number, press **[HELP]**.
- For further details about using the directory, see page 31.

- 7 Press **[FAX/START]**.

### Fax auto redial

If the line is busy or if there is no answer, the unit will automatically redial the number up to 5 times.

- This feature is also available for receiving polling (page 52) and delayed transmission (feature #25 on page 72).
- During redial, the following will be displayed.

WAITING REDIAL

- To cancel redialing, press **[STOP]**.

### If your unit does not send a fax

- Confirm the stored telephone number on the display and check that the number dialled is answered by the other party's machine (page 31).
- The connecting tone will be heard during dialling to tell you the status of the other party's machine (feature #76 on page 75).



## Broadcast transmission (KX-FT78 only)

This feature is useful for sending the same document to selected parties whose fax numbers are stored in the directory (up to 10 entries). Before programming, make sure that the desired stations have been stored in the directory (page 27).

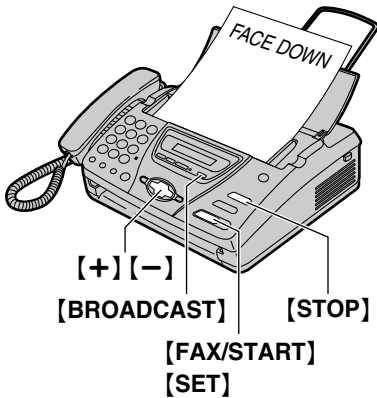

**1** Insert the document **FACE DOWN**.  
 • If necessary, press **[+]** or **[-]** repeatedly to select the desired resolution (page 37).

**2** Press **[BROADCAST]** until the following is displayed.

ENTRY BROAD

**3** Press **[SET]**.

DIR= [00]

**4** Press **[+]** or **[-]** until the desired name is displayed.

Example: Bill [±]

**5** Press **[SET]**.

Example: DIR=Bill [01]

- To program other stations, repeat steps 4 and 5 (up to 10 entries).

**6** Press **[FAX/START]** after programming all of the desired entries.

- The document will be fed into the unit and scanned into memory. The unit will then transmit the data to each entry, calling each number sequentially.
- After transmission, the stored document will be erased automatically, and the unit will automatically print a broadcast sending report.

**Note:**

- The record of the selected parties will be saved. To send to the same parties, see page 42.
- If you select the “FINE”, “SUPER FINE” or “PHOTO” resolution, the number of pages that the unit can transmit will decrease.
- If the document exceeds the memory capacity, sending will be cancelled.
- If one of the entries is busy or does not answer, it will be skipped. All skipped entries will be redialled up 5 times after all of the other entries have been called.

# Sending Faxes

---

## Sending to the same parties

When you make a broadcast transmission, the record of the selected parties will be saved. This feature is helpful if you often send the document to the same parties.

1. Insert the document FACE DOWN.
2. Press **[BROADCAST]** until the following is displayed.

RESEND

3. Press **[FAX/START]**.

---

## To cancel the broadcast setting

1. Press **[STOP]** while the unit displays the following.

BROADCASTING

- The display will show the following.

SEND CANCELLED?



YES : SET / NO : STOP

2. Press **[SET]**.

## Transmit polling (letting another machine retrieve a fax on your unit)

This feature allows another person to call your unit to retrieve a document loaded on your unit. This saves you the call charges. This feature will work when the unit is set to TAD/FAX (KX-FT78 only), TEL/FAX or FAX ONLY mode.

**Note:**

- The caller pays for the document transmission.
- When delayed transmission is set to on (feature #25 on page 72), transmit polling is not possible.

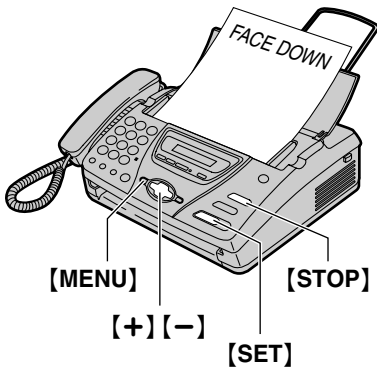

### To cancel the transmit polling

1. Press **[STOP]** while the unit is idle.



2. Press **[SET]**.

- 1 Insert the document **FACE DOWN**.
  - If necessary, press **[+]** or **[-]** repeatedly to select the desired resolution (page 37).

- 2 Press **[MENU]** repeatedly until the following is displayed.

POLLED

- 3 Press **[SET]**.

=OFF [±]

- 4 Press **[+]** or **[-]** to select "ON".

=ON [±]

- 5 Press **[SET]**.

POLLED ON

## Setting the unit to receive faxes

**Use as answering device and/or fax (KX-FT78 only)**

**Use only as a fax**

How you want the unit to receive calls



You want to receive all phone calls and faxes automatically.

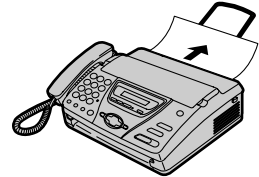

You have a separate telephone line just for faxes.

Set the unit this way.

**TAD/FAX mode (page 57)**

The arrow indicator on the display points to "TAD".

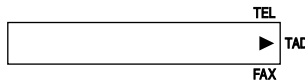

- If the arrow indicator points to "TEL", press [RECEIVE MODE].

**FAX ONLY mode (page 47)**

The arrow indicator on the display points to "FAX".

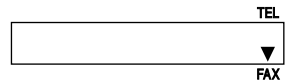

- If the arrow indicator points to "TEL", press [RECEIVE MODE].

This is how the unit will operate.

**When receiving phone calls:**

The unit will activate the answering device and record voice messages.

**When receiving faxes:**

The unit will activate the fax function to receive documents.

**When receiving calls:**

All incoming calls will be answered as faxes.

## Use as telephone/ automatic fax

## Mostly phone calls

## Other option

Fax receiving Phone call

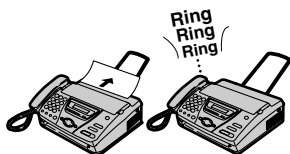

You want to answer the phone call yourself and receive faxes without rings.

Ring  
Ring  
Ring

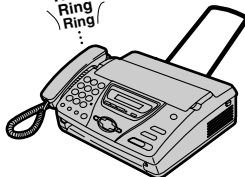

You plan to answer the calls yourself.

### Remote fax activation

You can also receive a fax using an extension telephone. While hearing a fax calling tone with an extension telephone, press **[\*][\*][\*][9]** to receive a fax (page 51).

### TEL/FAX mode (page 48)

The arrow indicators on the display point to both "TEL" and "FAX".

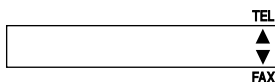

- If the arrow indicator points to "TEL", press **[RECEIVE MODE]**.

### TEL mode (page 46)

The arrow indicator on the display points to "TEL".

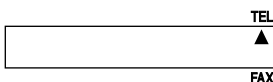

- If the arrow indicator(s) point(s) to "TAD", "FAX" or both "TEL" and "FAX", press **[RECEIVE MODE]**.

### When receiving phone calls:

The unit will ring.

### When receiving faxes:

The unit will receive fax documents without ringing.

### When receiving calls:

You have to answer all calls manually. To receive a fax document, press **[FAX/START]** for each fax you are receiving.

## TEL mode (answering all calls manually)

### Activating TEL mode

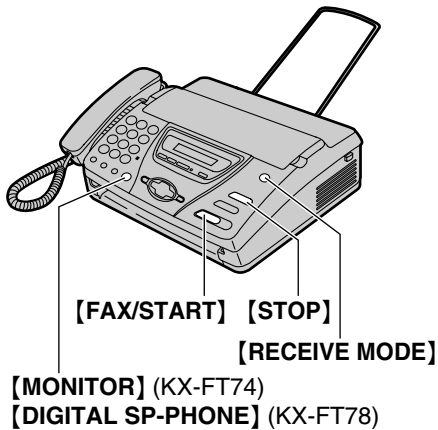

If the arrow indicator(s) on the display point(s) to "TAD" (KX-FT78 only), "FAX" or both "TEL" and "FAX", press **[RECEIVE MODE]**.



### Receiving a fax manually

**1** When the unit rings, lift the handset.  
• You can press **[MONITOR]** (KX-FT74)/**[DIGITAL SP-PHONE]** (KX-FT78).

**2** When document reception is required, a fax calling tone (slow beep) is heard, or no sound is heard, press **[FAX/START]**.



**3** Replace the handset if you are using it.  
• The unit will start fax reception.

#### Note:

- If you do not answer the call within 15 rings:

#### For KX-FT74:

The unit will temporarily switch to fax reception. The other party can then send a fax.

#### For KX-FT78:

The unit will temporarily activate the answering device. The greeting message will then be played and the other party can then send a fax.

- The received recording paper comes out somewhat longer than the document size.

### To stop receiving

Press **[STOP]**.

### Friendly reception feature

When you answer a call and hear a fax calling tone (slow beep), the unit will automatically start fax reception.

- If this feature is not required, set feature #46 to off (page 73).

### Fax reception in memory (KX-FT78 only)

When a printing problem is detected, the unit will temporarily store the received document into memory. While the document is in memory the display will show an error message and the following alternately.

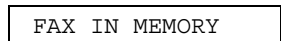

- Follow the instructions on page 77 to solve the problem.

## FAX ONLY mode (all calls are received as faxes)

### Activating FAX ONLY mode

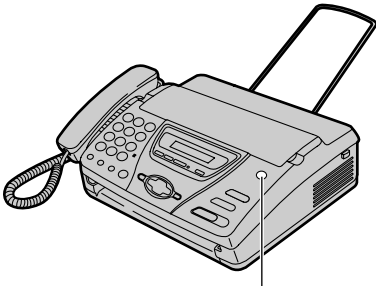

[RECEIVE MODE]

- 1 Set feature #05 to "FAX ONLY" (page 70).
- 2 If the arrow indicator on the display points to "TEL", press [RECEIVE MODE].



- When receiving calls, the unit will automatically answer all calls and only receive fax documents.

#### Note:

- The number of rings before a call is answered in FAX ONLY mode can be changed (feature #07 on page 70).
- This mode should not be used with a telephone line which is used for both phone calls and faxes. Fax communication will be attempted even if someone is trying to call you. We recommend the following setup:

#### Example:

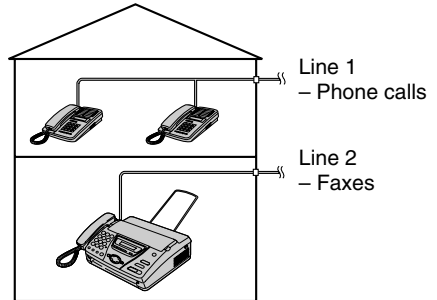

Only a fax machine is connected.

# TEL/FAX mode (receiving phone calls with ring signals and faxes without ring signals)

Use this mode when you are situated near the fax machine, and want to receive faxes without the fax machine ringing.

## Activating TEL/FAX mode

- 1 Set feature #05 to "TEL/FAX" (page 70).
- 2 If the arrow indicator on the display points to "TEL", press **[RECEIVE MODE]**.
- 3 The ringer volume setting should be on (page 26).



## When a fax call is received

- 1 When a call is received, the fax machine will not ring at this time.  

INCOMING CALL

  - Duration depends on "TEL/FAX delayed ring setting".
- 2 When the fax machine detects a fax calling tone, it will automatically receive documents without ringing.

### Note:

- A fax calling tone is automatically generated by the sending fax machine. Some fax machines do not have this capability.
- If the ring detection feature is set (page 55) and a different ring pattern is received, the fax machine will not receive a fax automatically.

---

### TEL/FAX delayed ring setting

The number of rings generated before the fax machine answers depends on the setting of feature #09 on page 70. The fax machine will not generate an audible ring during this time.



## When a phone call is received

- 1 When a call is received, the fax machine will not ring at this time.

INCOMING CALL

- Duration depends on “**TEL/FAX delayed ring setting**”.

- 2 When the fax machine does not detect a fax calling tone, it will ring **3 times**.



- Duration depends on “**Silent fax recognition ring setting**”.
- The calling party will hear a different ring back tone.
- If you have recorded your own TEL/FAX greeting message (page 58), it will be played to the calling party (KX-FT78 only).

- 3 Answer the call.

- If the call is not answered, the fax machine will activate the fax function for a case in which the other party's fax machine does not send a fax calling tone.

### Silent fax recognition ring setting

The fax machine generates audible rings to indicate that it is receiving a phone call. The number of rings generated depends on the setting of feature #30 on page 73. This signal will not ring on an extension telephone.

## When an extension telephone is connected and a fax call is received

- 1 When a call is received, the fax machine will not ring at this time, but the extension telephone will ring **2 times**.

INCOMING CALL

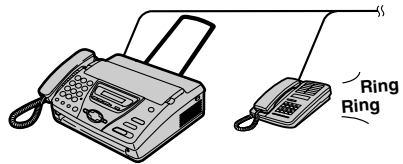

- Duration depends on “**TEL/FAX delayed ring setting**”.

- 2 When the fax machine detects a fax calling tone, the fax machine will automatically receive documents without ringing.

# Receiving Faxes

## When an extension telephone is connected and a phone call is received

- 1 When a call is received, the fax machine will not ring at this time, but the extension telephone will ring **2 times**.

INCOMING CALL

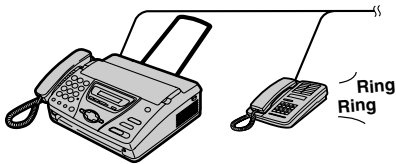

- Duration depends on “**TEL/FAX delayed ring setting**”.

- 2 The extension telephone will not ring, but the fax machine will ring **3 times**.

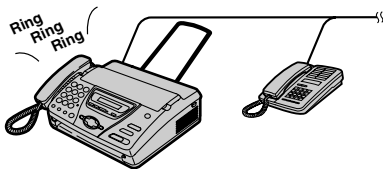

- Duration depends on “**Silent fax recognition ring setting**”.
- The calling party will hear a different ring back tone.
- If you have recorded your own TEL/FAX greeting message (page 58), it will be played to the calling party (KX-FT78 only).

- 3 Answer the call.  
You can answer the call with the extension telephone.

1. Lift the handset.
2. Press [**\***][**0**] while the ring back tone is heard.
  - This code can be changed in feature #49 on page 74.
  - If the call is not answered, the fax machine will activate the fax function for a case in which the other party's fax machine does not send a fax calling tone.

### Note:

- Even when you answer a call with the extension telephone and press the code, the fax machine may activate the fax function depending on the type of an extension telephone. Press [**STOP**] on the fax machine to talk with the calling party.

## Extension telephone

If you use the fax machine with an extension telephone, you can receive fax documents using the extension telephone. You do not have to press **[FAX/START]** on the fax machine.

### Important:

- Use a touch tone telephone as the extension telephone and enter the fax activation code firmly.

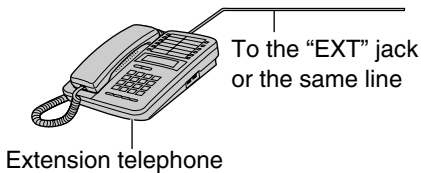

- 1** When the extension telephone rings, lift the handset of the extension telephone.
- 2** When document reception is required, a fax calling tone (slow beep) is heard, or no sound is heard, press **[\*][\*][\*][9]** (pre-selected fax activation code) firmly.
- 3** Hang up the handset.
  - The fax machine will start reception.

### Note:

- You can change the fax activation code in feature #41 (page 73).

# Receive polling (retrieving a fax placed on another fax machine)

This feature allows you to retrieve a document from another compatible machine. Therefore you pay for the call. Make sure that no documents are fed into your unit and that the other party's machine is ready for your call.

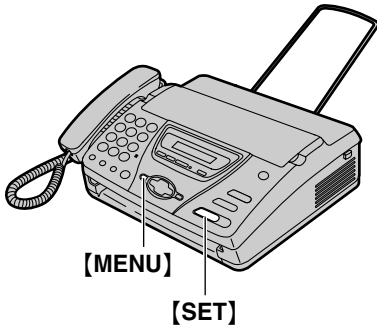

- 1 Press **[MENU]** repeatedly until the following is displayed.

POLLING

- 2 Press **[SET]**.

FAX=

- 3 Dial the fax number.

- 4 Press **[SET]**.

CONNECTING . . . . .

- The unit will start fax reception.

## Black list function

You can reject receiving facsimiles by registering the black list numbers. Up to 10 phone numbers can be stored as follows.

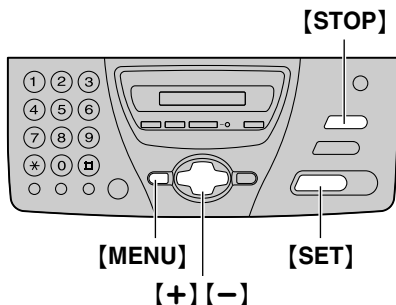

**1** Press **[MENU]**.

SYSTEM SET UP

**2** Press **[#]**, then **[2][7]**.

BLACK LIST

**3** Press **[SET]**.

=OFF [±]

**4** Press **[+]** or **[-]** to select "ON".

=ON [±]

- If this feature is not required, select "OFF".

**5** Press **[SET]**.

NO. =

**6** Enter the fax phone number you require as unauthorized number.

- You can enter a total of 22 digits.

Example: NO. =5552233

**7** Press **[SET]** to store.

NO. =

- To store other numbers, repeat from step 6.

**8** Press **[MENU]**.

### Note:

- If you make a mistake while programming, press **[STOP]**, then make the correction.
- To erase a programmed phone number, press **[STOP]** when the cursor is positioned on the first number in step 6.
- To confirm the programmed phone number, print out the feature list. See page 88.

# Receiving Faxes

## Pager call

This feature allows your unit to call your pager when your unit receives an incoming voice message (KX-FT78 only) or a fax document.

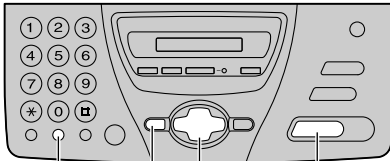

[MENU]

[SET]

[+][-]

[REDIAL/PAUSE]

(Pauses)

- 1 Press **[MENU]**.

SYSTEM SET UP

- 2 Press **[#]**, then **[7][0]**.

**KX-FT74:**

FAX PAGER CALL

**KX-FT78:**

PAGER CALL

- 3 Press **[SET]**.

=OFF [±]

- 4 Press **[+]** or **[-]** to select "ON".

=ON [±]

- If this feature is not required, select "OFF".

- 5 Press **[SET]**.

NO. =

- 6 Enter your pager number.
  - You can enter a total of 46 digits and/or pauses.

**Example:**

**1 202 555 1234PP12345678PP5555#**

- **1 202 555 1234:** Your pager number
- **PP:** Pauses
- **12345678:** Your pager access code, if required.
- **5555 (example):** Messages you want displayed on your pager.

- 7 Press **[SET]**.

- 8 Press **[MENU]**.

---

### When your pager receives a pager call

Your pager will display the message you entered in step 6 (for example: 5555).

## Using with the ring detection feature

When you subscribe to duplex ring service, your telephone company will assign you a new fax number and will also tell you the assigned ring pattern. Please complete the following setup on your fax machine to identify the assigned ring pattern.

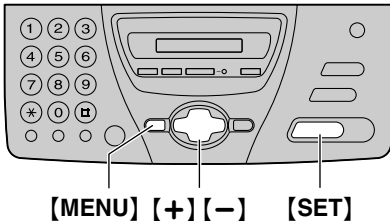

**1** Press **[MENU]**.

SYSTEM SET UP

**2** Press **[#]**, then **[3][1]**.

RING DETECTION

**3** Press **[SET]**.

=OFF [±]

**4** Press **[+]** or **[-]** to select "ON".

- If this feature is not required, select "OFF".

**5** Press **[SET]**.

PRINTING

- The unit will print an information list.

**6** Press **[MENU]**.

### Note:

- After programming, set the fax machine to TEL mode.
- In TEL mode, the fax machine will recognize incoming faxes on the first ring pattern and answer automatically. For phone calls, the fax machine will ring as a normal call.

## Making a copy

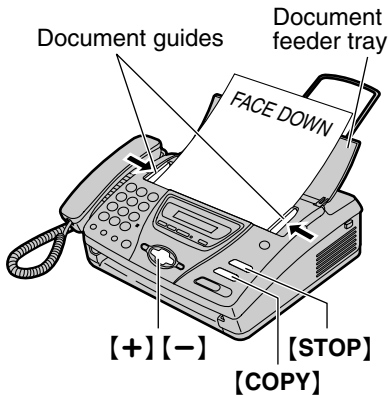

- 1 Open the document feeder tray.
- 2 Adjust the width of the document guides to the size of the document.
- 3 Insert the document (up to 10 pages) **FACE DOWN** until the unit grasps the document and a single beep is heard.

STANDARD [±]

- If necessary, press **[+]** or **[-]** repeatedly to select the desired resolution.

- 4 Press **[COPY]**.
  - The unit will start copying.

### Note:

- When you copy a multiple page document which is longer than A4 size paper (approx. 300 mm), we recommend you insert one page at a time.
- Any transmittable document can be copied (page 39).
- The copied recording paper comes out somewhat longer than the document size.

---

### To select the resolution

Select the desired resolution according to the type of document.

- **“FINE”**: For printed or typewritten originals with small printing.
- **“SUPER FINE”**: For originals with very small printing.
- **“PHOTO”**: For originals containing photographs, shaded drawings, etc.
- If you select **“STANDARD”**, copying will be done using **“FINE”** mode.

---

### To stop copying

Press **[STOP]**.

- To eject the document, press **[STOP]** again.



## TAD/FAX mode (receiving phone calls and faxes automatically)

When TAD/FAX mode is set, the unit will work as a fax machine and/or answering device.

If a fax tone is detected, the unit will automatically receive the fax. If a phone call is detected, the answering device will play a greeting message and the caller can leave a voice message.

### Setting up the voice and fax message reception

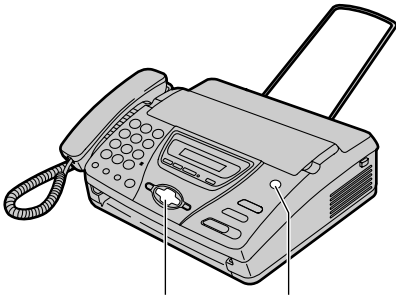

[+] [-] [RECEIVE MODE]

- 1 Make sure that feature #05 is set to "TAD/FAX" (page 70).
- 2 If the arrow indicator on the display points to "TEL", press [RECEIVE MODE].



- The unit will play the pre-recorded greeting message.
- The remaining time for recording incoming messages will be displayed.

Example: TIME = 10m13s

- You can change the speaker volume. Press [ + ] or [ - ] while listening to the greeting message.

#### Note:

- The incoming message recording time can be changed (feature #10 on page 71).
- When the remaining time is low, erase unnecessary messages (page 63).
- While an incoming call is being recorded, you can monitor it through the speaker. If this feature is not required, set feature #67 to off (page 74).

#### Ring setting in TAD/FAX mode

You can choose from 1, 2, 3, 4, "TOLL SAVER" and "RINGER OFF". This setting can be changed by feature #06 on page 70.

- "TOLL SAVER": When you call the unit from a remote location, the number of rings will tell you if there are any new voice messages. If the unit answers on the 2nd ring, there is at least one new recorded message. If the unit answers on the 4th ring, there are no new recorded messages. To save the toll charges for the call, hang up immediately when you hear the 3rd ring. The 3rd ring indicates that there are no new recorded messages.
- "RINGER OFF": The unit will answer without ringing.
- If you subscribe to a Caller ID service, set to 2 or more rings.

## Greeting (KX-FT78 only)

# Recording your own greeting messages

You can record your own greeting messages for TAD/FAX and TEL/FAX modes. The recording time will be limited to 16 seconds. We recommend you record a message less than 12 seconds in length to make it easier to receive faxes.

### Suggested message for TAD/FAX

**greeting:** "This is (your name, business and/or telephone number). We are unable to answer right now. To send a fax, start transmission. To leave a message, speak after the beep. Thank you."

### Suggested message for TEL/FAX

**greeting:** "This is (your name, business and/or telephone number). We are unable to answer right now. Please try again later. Thank you."

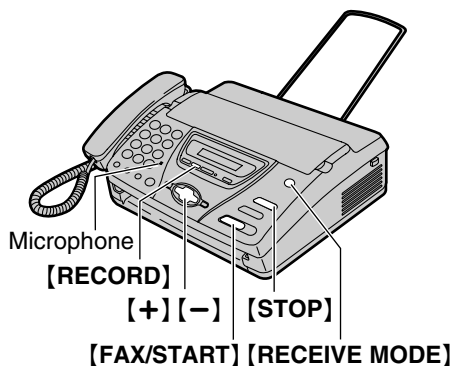

## 1 Start recording.

### For the TAD/FAX greeting

Press **[RECORD]** 2 times.

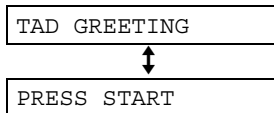

### For the TEL/FAX greeting

Press **[RECORD]** 3 times.

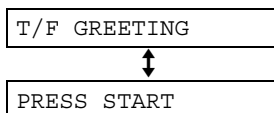

## 2 Press **[FAX/START]**.

- A long beep will sound and the display will show the following according to your selection in step 1.

### TAD/FAX:

TAD REC. 16s

### TEL/FAX:

T/F REC. 16s

## 3 Speak clearly about 20 cm away from the microphone.

- The display will show the remaining recording time.

## 4 When finished recording, press **[STOP]**.

- The unit will repeat your message. Adjust the volume using **[+]** or **[-]**.

## Note:

- You can choose 60 seconds for your own TAD/FAX greeting message (feature #54 on page 74).
  - If you change to 60 seconds, we recommend that you tell the caller in your own TAD/FAX greeting message to press \* \* \*9 before starting fax transmission.
  - If you change to 16 seconds from 60 seconds, your own TAD/FAX greeting message will be deleted. When receiving a call, the pre-recorded greeting message will be played.

---

## Checking the TAD/FAX greeting

1. Set to TAD/FAX mode (feature #05 on page 70).
2. If the arrow indicator on the display points to “TEL”, press **[RECEIVE MODE]**.  
If the arrow indicator on the display points to “TAD”, press **[RECEIVE MODE]** 2 times.

TAD/FAX MODE

- The unit will play the TAD/FAX greeting message.

---

## Checking the TEL/FAX greeting

1. Set to TEL/FAX mode (feature #05 on page 70).
2. If the arrow indicators on the display point to “TEL”, press **[RECEIVE MODE]**.  
If the arrow indicators on the display point to “TEL” and “FAX”, press **[RECEIVE MODE]** 2 times.

TEL/FAX MODE

- The unit will play the TEL/FAX greeting message.

## Greeting (KX-FT78 only)

# Erasing your own recorded greeting messages

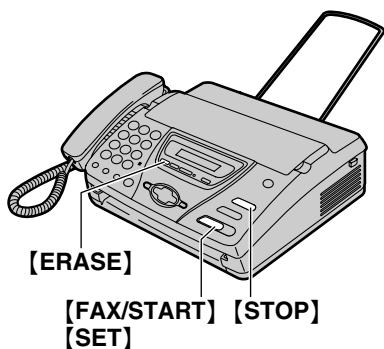

**1** Start erasing.

### For the TAD/FAX greeting

Press **[ERASE]** 2 times.

TAD GREETING



PRESS START

### For the TEL/FAX greeting

Press **[ERASE]** 3 times.

T/F GREETING



PRESS START

**2** Press **[FAX/START]**.

ERASE GREETING?



YES : SET / NO : STOP

- To cancel erasing, press **[STOP]**.

**3** Press **[SET]**.

GREETING ERASED

### Note:

- If you erase your own TAD/FAX greeting message, the pre-recorded greeting message will be played when receiving a call.

### Leaving a message for others or yourself

To leave a private message for yourself or someone else, you can record a voice memo. This memo can be played back later, either directly or remotely (page 62, 64).

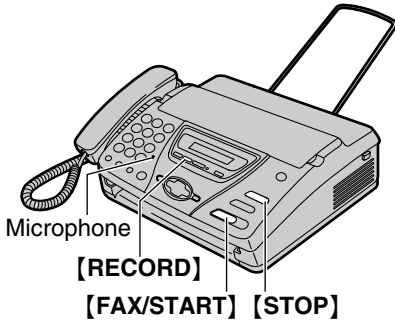

- 1 Press **[RECORD]**.

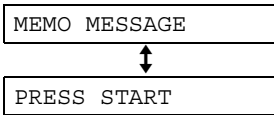

- 2 Press **[FAX/START]**.
  - A long beep will sound.



- 3 Speak clearly about 20 cm away from the microphone.
- 4 When finished recording, press **[STOP]**.

## Listening to recorded messages

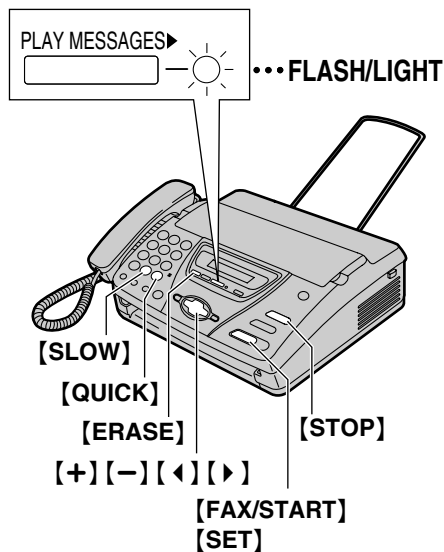

When the unit has recorded new voice messages;

- The PLAY MESSAGES indicator will flash.
- The display will show the total number of recorded messages.

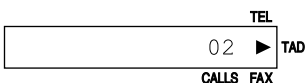
Example: 

- Slow beeps will sound if the message alert feature is activated (feature #42 on page 73).

Press **[PLAY MESSAGES]**.

- Only the new recorded messages will be played.
- Adjust the speaker volume using **[+]** or **[-]**.

- After playing back all of the new messages, the PLAY MESSAGES indicator will stop flashing but will remain lit up. If you press **[PLAY MESSAGES]** at this time, all the recorded messages will be played.

---

### To repeat a message

Press **[<]** while listening to the message.

- If you press **[<]** within 5 seconds of the beginning of the message, the previous message will be played.
- To play back a specific message, press **[<]** or **[>]** and search for the message you want to listen to.

---

### To skip a message

Press **[>]** to play the next message.

---

### To stop playback

Press **[STOP]**.

- If you press **[PLAY MESSAGES]** within 1 minute, the unit will resume playing the rest of the messages.

---

### Voice time/day stamp

During playback, a synthesised voice will announce the time and day of the week that each message was recorded.

---

### To change the playback speed

Press **[QUICK]** to play messages at one and a half times the original speed. Press **[SLOW]** to play messages at half the original speed.

- To return to the original speed, press **[QUICK]** or **[SLOW]** again during quick or slow playback.

## ***Incoming Messages (KX-FT78 only)***

---

### **To erase a specific message**

Press **[ERASE]** while listening to the message you want to erase.

---

### **To erase all the messages**

Check that you have listened to all of the recorded messages.

1. Press **[ERASE]**.

ALL MESSAGES



PRESS START

2. Press **[FAX/START]**.

ERASE MESSAGES?



YES : SET / NO : STOP

3. Press **[SET]**.

### **Operating from a remote location**

You can call your unit from a remote location and access the answering device.

**Important:**

- **Program the remote operation ID beforehand (feature #11 on page 71).**
- **Set the unit to TAD/FAX mode before going out (page 57).**
- **Use a touch tone telephone for remote operations.**

**Helpful hint:**

- Please cut off or make a copy of the card on page 65, and carry the card when you go out.
- When you press a key, press firmly.
- Press the remote command key within 10 seconds.

### **Listening to recorded messages**

- 1** Call your unit.
- 2** Press the remote operation ID during the TAD/FAX greeting message.
- 3** Start remote operations.

**When there are new recorded messages**

1. A long beep will sound.
2. Short beep(s) will sound up to 8 times.
  - This indicates the number of new messages.
3. New messages will be played back.

**When there are no new messages**

A short beep will not sound.

1. Wait for 4 seconds or press **[5]**.
2. All the recorded messages will be played back.

### **Remote operations using the remote command key**

**[1]:** repeats a message. If you press this key within 5 seconds of the beginning of a message, the previous message will be played.

**[2]:** skips a message.

**[4]:** repeats only the new messages.

**[5]:** plays back all the messages.

**Note:**

- When voice memory of your unit is full, erase unnecessary messages.



## Other remote operations

### Erasing a specific message

Press **[\*][4]** while listening to the message you want to erase.

- A long beep and 3 short beeps will sound. The unit will then play back the next message.

### Erasing all the messages

Press **[\*][5]** to erase all the messages.

- A long beep and 3 short beeps will sound.

### Monitoring the room

Press **[6]** to monitor the sound for about 30 seconds in the room where the unit is installed.

- After 30 seconds, a beep sounds. To continue monitoring, press **[6]** again within 10 seconds.

### Recording a marker message

After playing back the recorded messages, you can leave an additional message.

1. Wait for 3 beeps indicating the end of the remote operation.
2. Hear 1 beep.
3. Wait about 10 seconds.
4. Hear the voice guide or hear 1 beep.
5. Leave a message.

### Re-recording a greeting message

You can change the contents of the TAD/FAX greeting message.

1. Press **[7]** to start recording.
  - A long beep will sound.
2. Speak clearly up to 16 seconds.
  - If you pause for over 2 seconds, 6 beeps will sound and the recording will stop. Repeat from step 1 within 10 seconds.
3. When finished recording, press **[9]**.
  - The new greeting message will be played.

## Answering device remote operation

| Answering device remote operation   |                               |                     |                            |
|---|-------------------------------|---------------------|----------------------------|
| 1. Call your unit.<br>2. Press the remote operation ID during the greeting message.<br>3. Press the remote command key. |                               | Key                 | Remote command             |
|   |                               |                     | <b>[9]</b>                 |
| Key   | Remote command                | <b>[*][4]</b>       | Erases a specific message  |
| <b>[0]</b>  | Skips the greeting message    | <b>[*][5]</b>       | Erases all messages        |
| <b>[1]</b>  | Repeats a message             | <b>[8][0]</b>       | Changes to TEL mode        |
| <b>[2]</b>  | Skips a message               | <b>[8][1]</b>       | Turns on message transfer  |
| <b>[4]</b>  | New message playback          | <b>[8][2]</b>       | Turns off message transfer |
| <b>[5]</b>  | All message playback          | <b>[8][3]</b>       | Turns on pager call        |
| <b>[6]</b>  | Room monitor                  | <b>[8][4]</b>       | Turns off pager call       |
| <b>[7]</b>  | Re-records a greeting message | <b>[*][*][*][9]</b> | Activates fax function     |

## **Remote Operation (KX-FT78 only)**

---

### **Skipping the greeting message**

Press **[0]** during the greeting message playback.

- The unit will skip the rest of the greeting message.

### **Turning the message transfer on or off**

You must program a transfer telephone number beforehand (feature #60 on page 74).

Press **[8][1]** to turn on the message transfer.

Press **[8][2]** to turn off the message transfer.

- If a transfer telephone number is not programmed, you cannot turn this feature on. 6 beeps will sound.

### **Turning the pager call on or off**

You must program a pager number beforehand (feature #70 on page 54).

Press **[8][3]** to turn on the pager call.

Press **[8][4]** to turn off the pager call.

- If a pager number is not programmed, you cannot turn this feature on. 6 beeps will sound.

### **Changing the receive mode**

Press **[8][0]** to change the receive mode from TAD/FAX to TEL.

- You cannot return to TAD/FAX mode in the same call. To return to TAD/FAX mode, see the following.

### **Setting to TAD/FAX mode from TEL mode**

1. Call your unit and wait for 15 rings.
  - The answering device will temporarily answer the call.
2. Enter the remote operation ID during the greeting message.
  - A long beep will sound, and your unit will switch to TAD/FAX mode.
3. Hang up the handset.

## Transferring recorded messages to another telephone

This feature allows your unit to call a designated telephone number each time an incoming voice message is recorded. You can retrieve the transferred message during the same call using the remote operation.

### Important:

- **To use this feature, program the transfer telephone number first (feature #60 on page 74) and set the unit to TAD/FAX mode.**
- **You must set the voice guidance feature to on (feature #47 on page 74) or record your own transfer greeting message beforehand.**

How this feature works:

1. An incoming voice message is recorded in your unit.
2. Your unit calls the transfer telephone number.
3. Answer the call with the transfer telephone.
4. Your unit will play the pre-recorded transfer greeting message.
  - You can record your own transfer greeting message.
5. Enter the remote operation ID, and retrieve the message using the remote operation (page 64).

## Recording your own transfer greeting message

The recording time is limited to 16 seconds.

**Suggested message:** *"This is a transferred message from (your name, business and/or telephone number). Please enter your remote ID for remote operation."*

- 1 Press **[MENU]**.

SYSTEM SET UP

- 2 Press **[⇄]**, then **[6][1]**.

TRNS-GREETING

- 3 Press **[SET]**.

CHECK [±]

- 4 Press **[+]** or **[-]** to select "RECORD".

RECORD [±]

- 5 Press **[SET]**.

- 6 Speak clearly about 20 cm away from the microphone.

- The display will show the remaining recording time.

Example: TRNS REC. 15s

- 7 When finished recording, press **[STOP]**.

- The unit will repeat your message. Adjust the volume using **[+]** or **[-]**.

- 8 Press **[MENU]**.

## ***Option (KX-FT78 only)***

---

### **To check the transfer greeting message**

1. Press **[MENU]**, **[#][6][1]**, then **[SET]**.
2. Press **[+]** or **[-]** to select "CHECK".
3. Press **[SET]**.
  - The unit will play the message.
4. Press **[MENU]**.

---

### **To erase your own transfer greeting message**

1. Press **[MENU]**, **[#][6][1]**, then **[SET]**.
2. Press **[+]** or **[-]** to select "ERASE".
3. Press **[SET]**.
  - Your own message will be erased.
4. Press **[MENU]**.

#### **Note:**

- When transferring a call, the pre-recorded transfer greeting message will be played.
- If the voice guidance feature is set to off (feature #47 on page 74) and you have erased your own transfer greeting message, the message transfer feature will be cancelled.

## Programming

The unit provides various programming features.

### General programming method

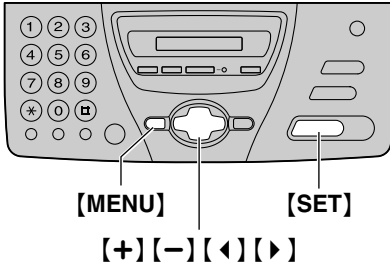

- 1 Press **[MENU]**.

SYSTEM SET UP

- 2 Press **[SET]**.

PRESS [◀▶] & [SET]

- 3 Select the feature you wish to program.

#### For basic features

Press **[◀]** or **[▶]** until the desired feature is displayed.

#### For advanced features

1. Press **[◀]** or **[▶]** until the following is displayed:

ADVANCED MODE

2. Press **[SET]**.
  3. Press **[◀]** or **[▶]** until the desired feature is displayed.
- 4 Press **[SET]**.
    - The current setting of the feature will be displayed.

- 5 Press **[+]** or **[-]** until the desired setting is displayed.
  - This step may be slightly different depending on the feature.

- 6 Press **[SET]**.
  - The setting you selected is set, and the next feature will be displayed.

- 7 To exit programming, press **[MENU]**.

### Programming by entering the program code number directly

You can select a feature by directly entering the program code (# and 2-digit number) instead of using **[◀]** or **[▶]**.

1. Press **[MENU]**.
2. Press **[#]** and the 2-digit code number.
3. Follow steps 4 to 7 in this page.

### To cancel programming

Press **[MENU]** to exit the program.

# Features Summary

---

## Basic features

---

### Code #01: Setting the date and time

SET DATE & TIME

See page 22 for details.

---

### Code #02: Setting your logo

YOUR LOGO

See page 23 for details.

---

### Code #03: Setting your fax number

YOUR FAX NO.

See page 25 for details.

---

### Code #04: Printing the sending report

SENDING REPORT

To print and check the sending report for fax transmission results (page 38).

**ERROR (default):** The sending report will be printed only when fax transmission fails.

**ON:** The sending report will be printed out after every transmission.

**OFF:** The sending report will not be printed out.

---

### Code #05 (KX-FT74 only): Changing the receiving mode in the auto answer mode

AUTO ANSWER

**FAX ONLY (default):** Facsimile Only mode (page 47)

**TEL/FAX:** Telephone/Facsimile mode (page 48)

---

### Code #05 (KX-FT78 only): Changing the receiving mode in the auto answer mode

AUTO ANSWER

**TAD/FAX (default):** Telephone Answering Device/Facsimile mode (page 57)

**FAX ONLY:** Facsimile Only mode (page 47)

**TEL/FAX:** Telephone/Facsimile mode (page 48)

---

### Code #06 (KX-FT78 only): Changing the ring setting in TAD/FAX mode

TAD RING COUNT

To change the number of rings before the unit answers a call in TAD/FAX mode. You can select from **1, 2 (default), 3, 4**, "TOLL SAVER" and "RINGER OFF". See page 57 for details.

---

### Code #07: Changing the ring setting in FAX ONLY mode

FAX RING COUNT

To change the number of rings before the unit answers a call in FAX ONLY mode. You can select from **1, 2 (default), 3** and **4**.

---

### Code #09: Changing the TEL/FAX delayed ring setting

TEL/FAX RING

If you use an extension telephone in TEL/FAX mode, select the desired number of rings of the extension telephone. You can select from **1, 2 (default), 3** and **4**. See page 48, 49, 50 for details.

---

## Code #10 (KX-FT78 only): Changing the incoming message recording time

RECORDING TIME

**VOX (default):** Unlimited.

**1 MIN:** Up to 1 minute.

---

## Code #11 (KX-FT78 only): Setting the remote operation ID

REMOTE TAD ID

1. Follow steps 1–4 on page 69.
2. Enter any 3-digit number.
  - The default code is “111”.
  - Do not use 0 and 7.
3. Press **[SET]**.
4. Press **[MENU]**.

---

## Code #13: Setting the dialling mode

DIALLING MODE

If you cannot dial, change this setting depending on your telephone line service.

**TONE (default):** For tone dial service.

**PULSE:** For rotary pulse dial service.

## Advanced features

---

### Code #22: Setting the journal report to print automatically

AUTO JOURNAL

**ON (default):** The unit will print the journal report automatically after every 35 new fax communications (page 38).

**OFF:** The unit will not print the journal report, but keep records of the last 35 fax communications.

---

### Code #23: Sending document overseas

OVERSEAS MODE

If you have difficulty sending an overseas fax, activate this feature before starting transmission. This feature makes sending documents easier as the transmission speed is slowed down.

- This feature is not available for broadcast transmission (KX-FT78).
- The calling charge may be higher.

**ON:** After transmission, this feature will turn off automatically.

**OFF (default):** Deactivated this feature.

---

### Code #25: Sending a fax at a specific time

DELAYED SEND

This feature allows you to take advantage of low-cost calling hours offered by your telephone company. The feature can be set up to 24 hours in advance of the desired time.

- When the transmit polling (page 43) is set to on, this feature is not available.

To send a document:

1. Insert the document.
  2. Follow steps 1–4 on page 69.
  3. Press **[+]** or **[-]** to select “ON”.
  4. Press **[SET]**.
  5. Enter the fax number.
  6. Press **[SET]**.
  7. Enter the transmission start time. Press **[\*]** to select “AM” or “PM”.
  8. Press **[SET]**.
  9. Press **[MENU]**.
- To cancel after programming, press **[STOP]** then **[SET]**.

---

### Code #26: Setting the Caller ID list to print automatically

AUTO CALL. LIST

**ON (default):** The unit will print the Caller ID list automatically after every 20 new calls (page 33).

**OFF:** The unit will not print the Caller ID list, but keep records of the last 20 caller information.

---

### Code #27: Setting the black list function

BLACK LIST

See page 53 for details.



---

## Code #30: Changing the silent fax recognition ring setting

SILENT FAX RING

To change the number of rings when the unit detects a phone call in TEL/FAX mode. You can select from **3 (default)**, **4**, **5**, **6**, **7**, **8** and **9**. See page 49 for details.

---

## Code #31: Setting the ring detection

RING DETECTION

See page 55 for details.

---

## Code #39: Changing the display contrast

LCD CONTRAST

**NORMAL (default):** For normal contrast.

**DARKER:** Used when the display contrast is too light.

---

## Code #41: Changing the fax activation code

FAX ACTIVATION

If you use an extension telephone and wish to use it to receive a fax, activate this feature and program the activation code.

1. Follow steps 1–4 on page 69.
2. Press **[+]** or **[-]** to select “ON”.
3. Press **[SET]**.
4. Enter your code from 2 to 4 digits, using 0–9 and **\***.
  - The default code is “\*\* \*9”.
  - Do not enter “0000”.
5. Press **[SET]**.
6. Press **[MENU]**.

---

## Code #42 (KX-FT78 only): Setting the message alert

MESSAGE ALERT

To alert you with beeps when a new voice message is recorded. If you hear slow beeps, press **[PLAY MESSAGES]** and listen to recorded messages. The beeps will stop.

**ON:** You will hear a beeping sound.

**OFF (default):** Deactivated this feature.

---

## Code #43 (KX-FT78 only): Setting the recording time alert

REC. TIME ALERT

To alert you with beeps when there is less than 60 seconds of remaining recording time. If you hear slow beeps, erase the recorded messages (page 63). The beeps will stop.

**ON:** You will hear a beeping sound.

**OFF (default):** Deactivated this feature.

---

## Code #46: Setting the friendly reception

FRIENDLY RCV

To receive a fax automatically when you answer a call and hear a fax calling tone (slow beep).

**ON (default):** You do not have to press **[FAX/START]** for fax reception.

**OFF:** You have to press **[FAX/START]** for fax reception.

# Features Summary

---

---

## Code #47 (KX-FT78 only): Setting the voice guidance

VOICE GUIDANCE

If you wish to hear voice guidance, activate this feature.

**ON (default):** You will hear the friendly reception voice guide, pre-recorded messages and voice time/day stamp.

**OFF:** Deactivated this feature.

---

## Code #49: Setting the auto disconnection

AUTO DISCONNECT

To answer a call with an extension telephone in TEL/FAX mode (page 50), activate this feature and program the code.

1. Follow steps 1–4 on page 69.
2. Press **[+]** or **[-]** to select “ON”.
3. Press **[SET]**.
4. Enter your code from 2 to 4 digits, using 0–9 and **\***.
  - The default code is “\*0”
5. Press **[SET]**.
6. Press **[MENU]**.

---

## Code #54 (KX-FT78 only): Changing the recording time for your own TAD/FAX greeting message

GREETING TIME

**16s (default):** Up to 16 seconds.

**60s:** Up to 60 seconds.

See page 59 for details.

---

## Code #58: Setting the original mode

ORIGINAL

To send or copy a document with faint or dark writing, set this feature before starting transmission or copying.

**NORMAL (default):** Used for normal writing.

**LIGHT:** Used for faint writing.

**DARKER:** Used for dark writing.

---

## Code #60 (KX-FT78 only): Setting the message transfer

MESSAGE TRANS.

To transfer a recorded incoming message to another telephone (page 67), activate this feature and program the transfer telephone number.

1. Follow steps 1–4 on page 69.
2. Press **[+]** or **[-]** to select “ON”.
3. Press **[SET]**.
4. Enter the transfer telephone number.
5. Press **[SET]**.
6. Press **[MENU]**.

---

## Code #61 (KX-FT78 only): Checking, recording or erasing the transfer greeting message

TRANS-GREETING

See page 67, 68 for details.

---

## Code #67 (KX-FT78 only): Setting the incoming message monitor

ICM MONITOR

To hear an incoming message (ICM) from the speaker when the answering device is recording the message.

**ON (default):** You can monitor the incoming message.

**OFF:** Deactivated this feature.

---

## Code #70: Calling your pager (KX-FT74)

FAX PAGER CALL

## (KX-FT78)

PAGER CALL

See page 54 for details.

---

## Code #76: Setting the connecting tone

CONNECTING TONE

If you often have trouble when sending a fax, this feature allows you to hear connecting tones; fax tone, ring back tone and busy tone. You can confirm the status of the other party's machine.

- If the ring back tone continues, the other party's machine may not be a facsimile or may have run out of paper. Check with the other party.
- The connecting tone volume cannot be adjusted.

**ON (default):** You will hear connecting tones.

**OFF:** Deactivated this feature.

---

## Code #80: Resetting advanced features to their default settings

SET DEFAULT

To reset the advanced features:

1. Follow steps 1–4 on page 69.
2. Press **[+]** or **[-]** to select "YES".
3. Press **[SET]**.
4. Press **[SET]** again.
5. Press **[MENU]**.

## Reports

If your unit cannot send a fax, check the following:

- The number you dialled is correct.
- The other party's machine is a facsimile.

If the problem remains, correct it by following the communication message printed on the sending and journal reports (page 38).

### COMMUNICATION ERROR

(Code: 41-72, FF)

- A transmission or reception error occurred. Try again or check with the other party.

### DOCUMENT JAMMED

- The document is jammed. Remove the jammed document (page 82).

### ERROR-NOT YOUR UNIT

(Code: 53, 54, 59, 70)

- A transmission or reception error occurred because of a problem with the other party's fax machine. Check with the other party.

### MEMORY FULL

- The document was not received as a result of the memory being full.

### NO DOCUMENT

- The document was not fed into the unit properly. Reinsert the document and try again.

### OTHER FAX NOT RESPONDING

- The other party's fax machine is busy or has run out of recording paper. Try again.
- The document was not fed properly. Reinsert the document and try again.
- The other party's fax machine rings too many times. Send the fax manually (page 37).
- The other party's machine is not a facsimile. Check with the other party.
- The number you dialled is not in service.

### PAPER JAMMED

- The recording paper is jammed. Clear the jammed paper (page 83).

### PAPER OUT

- The unit has run out of recording paper. Install a recording paper roll (page 21).
- The cover was opened. Close it and try again.

### PRESSED THE STOP KEY

- **[STOP]** was pressed and fax communication was cancelled.

### PRINTER OVERHEATED

- The printer overheated. Let the unit cool down.

### THE COVER WAS OPENED

- The cover was opened. Close it and try again.

### OK

- Fax communication was successful.

## Display

If the unit detects a problem, one or more of the following messages will appear on the display.

CALL SERVICE 1

- There is something wrong with the unit. Contact our service personnel.

CHECK COVER



OUT OF PAPER

- The cover is open. Close it.
- The unit has run out of recording paper. Install a recording paper roll (page 21).

CHECK DOCUMENT

- The document was not fed into the unit properly. Reinsert the document. If misfeeding occurs frequently, clean the document feeder rollers (page 84) and try again.
- Attempted to transmit a document longer than 600 mm. Press **[STOP]** to remove the document. Divide the document into two or more sheets and try again.

CHECK MEMORY

- The memory (telephone numbers, parameters, etc.) has been erased. Re-program.

DIRECTORY FULL

- There is no space to store new entries in the directory. Erase unnecessary entries (page 30).

FAX IN MEMORY

- The unit has a document in memory. See the other displayed message instructions to print out the document.

MEMORY FULL

- There is no room left in memory to record a voice message. Erase unnecessary messages (page 63, 65).

NO RESPONSE

- The other party's fax machine is busy or has run out of recording paper. Try again.

NO TAD GREETING

- Your TAD/FAX greeting message is not recorded. Record a message (page 58).
- The voice guidance feature is set to off. Activate feature #47 on page 74. Pre-recorded greeting message will be adopted.

NO TRNS-GREET.

- Your transfer greeting message is not recorded. Record a message (page 67).
- The voice guidance feature is set to off. Activate feature #47 on page 74. Pre-recorded greeting message will be adopted.

PAPER JAMMED

- A recording paper jam occurred. Clear the jammed paper (page 83).

POLLING ERROR

- The other party's fax machine does not provide the polling function. Check with the other party.

REDIAL TIME OUT

- The other party's fax machine is busy or has run out of recording paper. Try again.

REMOVE DOCUMENT

- The document is jammed. Remove the jammed document (page 82).

## ***Error Messages***

---

### TRANSMIT ERROR

- A transmission error occurred. Try again.

### UNIT OVERHEATED

- The unit is too hot. Let the unit cool down.

# When a function does not work, check here

## General

---

### I cannot make and receive calls.

- The power cord or telephone line cord is not connected. Check the connections (page 19).
- If you used a splitter to connect the unit, remove the splitter and connect the unit to the wall jack directly. If the unit operates properly, check the splitter.

---

### I cannot make calls.

- The dialling mode setting is wrong. Change the setting of feature #13 (page 71).

---

### The unit does not work.

- Disconnect the unit from the telephone line and connect the line to a known working telephone. If the working telephone operates properly, contact our service personnel to have the unit repaired. If the working telephone does not operate properly, contact your telephone company.

---

### The unit does not ring.

- The ringer volume is set to off. Adjust it (page 26).
- The ring setting of feature #06 is set to "RINGER OFF". Change to another ring setting (page 70) (KX-FT78 only).

---

### The other party complains they only hear a fax tone and cannot talk.

- FAX ONLY mode is set. Tell the other party the number is only used for faxes.
- Change the receiving mode:
  - KX-FT74: TEL mode (page 46) or TEL/FAX mode (page 48).
  - KX-FT78: TAD/FAX mode (page 57), TEL mode (page 46) or TEL/FAX mode (page 48).

- If you use a duplex ring service, change to TEL mode.
- If you use a duplex ring service, make sure you have set the same ring pattern assigned by the telephone company (page 55).

---

### The [REDIAL/PAUSE] button does not function properly.

- If this button is pressed during dialling, a pause will be inserted. If pressed immediately after a dial tone is obtained, the last number dialled will be redialled.

---

### The receiving mode does not function properly.

- A ring detection feature #31 is set (page 55).
- TEL/FAX mode is set (page 48).

---

### During programming, I cannot enter the code or ID number.

- All or part of the numbers are the same. Change the number: feature #11 (page 71), #41 (page 73) and #49 (page 74).

---

### The speakerphone is not working (KX-FT78 only).

- Use the speakerphone in a quiet room.
- If you have difficulty hearing the other party, adjust the volume.

## Fax – sending

---

### I cannot send documents.

- The telephone line cord is connected to the EXT jack on the unit. Connect to the LINE jack (page 19) (KX-FT74 only).
- The other party's fax machine is busy or has run out of recording paper. Try again.
- The other party's machine is not a facsimile. Check with the other party.
- The other party's fax machine rings too many times. Send the fax manually (page 37).

# Frequently Asked Questions

---

## **The other party complains that letters on their received document are distorted or not clear.**

- If your line has special telephone services such as call waiting, the service may have been activated during fax transmission. Connect the unit to a line that does not have these services.
- The extension telephone on the same line is off the hook. Hang up the extension telephone and try again.
- Try copying the document. If the copied image is clear, there may be something wrong with the other party's machine.

## **The other party complains that dirty patterns or black lines appear on their received document.**

- The glass or rollers are dirty. Clean them (page 84).

## **I cannot send a fax overseas.**

- Use the overseas transmission mode of feature #23 (page 72).
- Add two pauses at the end of the telephone number or dial manually.

## **Fax – receiving**

---

### **I cannot receive documents.**

- The telephone line cord is connected to the EXT jack on the unit. Connect to the LINE jack (page 19) (KX-FT74 only).

### **I cannot receive documents automatically.**

- The receiving mode is set to TEL mode. Change the receiving mode:
  - KX-FT74: FAX ONLY mode (page 47) or TEL/FAX mode (page 48).
  - KX-FT78: TAD/FAX mode (page 57), FAX ONLY mode (page 47) or TEL/FAX mode (page 48).
- The time taken to answer the call is too long. Decrease the number of rings: feature #06 (page 70), #07 (page 70), #09 (page 70) and #30 (page 73).

- The greeting message is too long. Shorten the message (page 58) (KX-FT78 only).

## **The display shows the following, but faxes are not received.**

CONNECTING . . . . .

- The incoming call is not a fax. Change the receiving mode:
  - KX-FT74: TEL mode (page 46).
  - KX-FT78: TEL mode (page 46) or TAD/FAX mode (page 57).

## **A blank sheet is ejected.**

- The recording paper roll is not installed correctly. Make sure that the shiny side of the paper is facing down and re-install the paper (page 21).
- The other party placed the document in their fax machine the wrong way. Check with the other party.

## **A white line or a dirty pattern appears on your recording paper.**

- The glass or rollers are dirty. Clean them (page 84).

## **The printing quality is poor.**

- The other party sent a faint document. Ask them to send a clearer copy of the document.
- The thermal head is dirty. Clean it (page 86).

## **The other party complains that they cannot send a document.**

- The memory is full of received documents due to a lack of recording paper or a recording paper jam. Install paper (page 21) or clear the jammed paper (page 83) (KX-FT78 only).



### Receiving mode

---

**I cannot select the desired receiving mode.**

- If you want to set TAD/FAX (KX-FT78 only), FAX ONLY or TEL/FAX mode, select the desired mode using feature #05 (page 70), and press **[RECEIVE MODE]** repeatedly until the desired mode is displayed.
  - If you want to set TEL mode, press **[RECEIVE MODE]** repeatedly until TEL mode is displayed.
- 

**The other party complains that they cannot send a document.**

- Press **[RECEIVE MODE]** repeatedly until TAD/FAX (KX-FT78 only), FAX ONLY or TEL/FAX mode is displayed.
- 

### Copying

---

**The unit does not make a copy.**

- You cannot make a copy during programming. Make the copy after programming or stop programming.
- 

**A black line, a white line or a dirty pattern appears on the copied document.**

- The glass or rollers are dirty. Clean them (page 84).
- 

**The copied image is distorted.**

- The thermal head is dirty. Clean it (page 86).
- 

**The copied document is blank.**

- The recording paper roll is not installed correctly. Make sure that the shiny side of the paper is facing down and re-install the paper (page 21).
- 

### Answering device (KX-FT78 only)

---

**I cannot retrieve recorded messages from a remote location.**

- Press the remote operation ID correctly and firmly (page 64).
- 

**The other party complains that they cannot leave a voice message.**

- The memory is full. Erase unnecessary messages (page 63).
- 

### If a power failure occurs

- The unit will not function.
- The unit is not designed for making emergency telephone calls when the power fails. Alternative arrangements should be made for access to emergency services.
- Fax transmission and reception will be interrupted.
- If the delayed transmission (feature #25 on page 72) is programmed and the start time is passed during a power failure, transmission will be attempted soon after power is restored.

## Document jams – sending

If the unit does not release the document during feeding, remove the jammed document.

- 1 Open the cover by pressing the cover open button and remove the jammed document carefully.

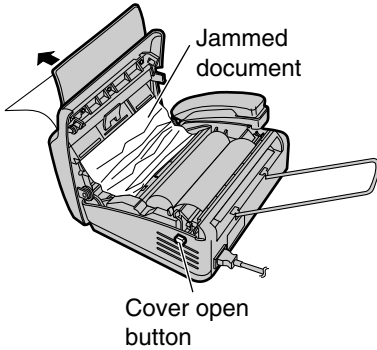

- Do not pull out the jammed document forcibly before opening the cover.

- 2 Close the cover securely by pushing down on both sides.

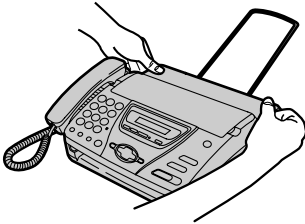

## Recording paper jam

If the unit does not eject any recording paper during fax reception or copying, the recording paper has jammed. Remove the jammed paper.

- 1 Open the cover by pressing the cover open button. Lift the green lever to release the paper cutter, and remove the recording paper roll.

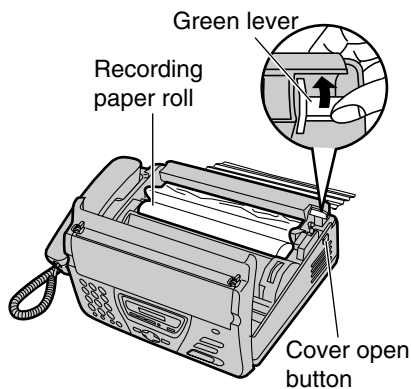

- 2 Cut off the wrinkled portion, and replace the recording paper roll into the unit in the proper direction.

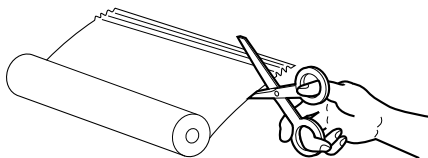

- 3 Insert the leading edge of the paper into the opening above the thermal head, and pull the paper out of the unit.

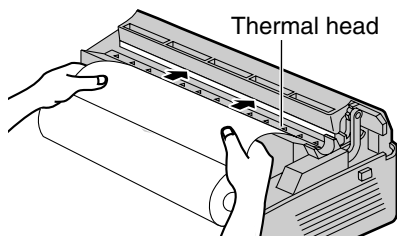

- Make sure that there is no slack in the paper roll.
- If the paper cannot be inserted, try lifting the green lever again.

- 4 Close the cover securely by pushing down on both sides.

PRESS START

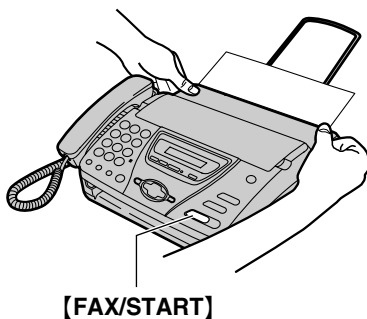

- 5 Press **[FAX/START]**.
  - The unit will eject the paper slightly and cut it.
  - If you do not press **[FAX/START]** within 30 seconds, the unit will automatically eject the paper slightly and cut it.
  - Every time you close the cover a message will be printed. If the recording paper is set to the wrong side, a message will not be printed. Install the paper correctly.

## Document feeder

Clean the document feeder in the following cases:

- If misfeeding of the document occurs frequently.
- If dirty patterns or black/white bands appear on the original document when transmitting or copying.

- 1** Disconnect the power cord and the telephone line cord.

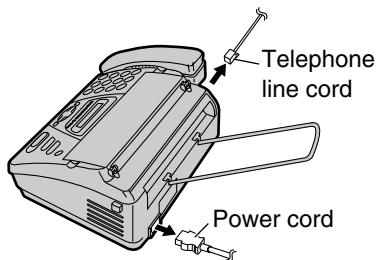

- 2** Open the cover by pressing the cover open button.

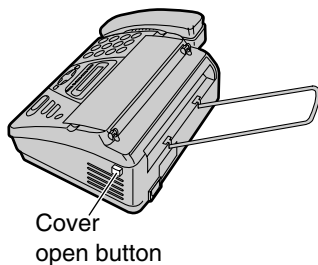

- 3** Clean the document feeder rollers and rubber flap with a cloth moistened with isopropyl rubbing alcohol, and let all parts dry thoroughly.

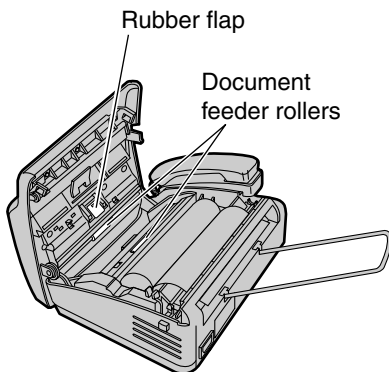

- 4** Clean the white plate and glass with a soft and dry cloth.

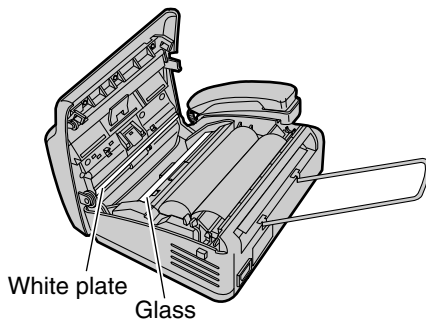

- 5** Close the cover securely by pushing down on both sides.

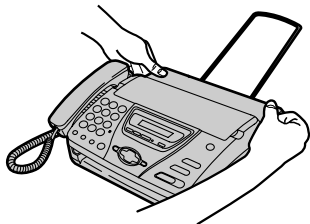

- 6** Connect the power cord and the telephone line cord.

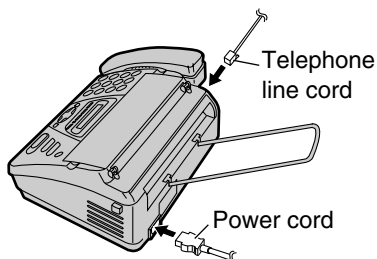

**Caution:**

- Do not use paper products, such as paper towels or tissues, to clean the inside of the unit.

## Thermal head and head cover

If dirty patterns or black/white bands appear on a copied/received document, check whether there is dust on the thermal head and head cover. Clean them to remove the dust.

- 1** Disconnect the power cord and the telephone line cord.

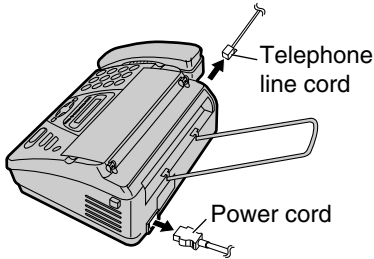

- 2** Open the cover by pressing the cover open button and remove the recording paper roll.

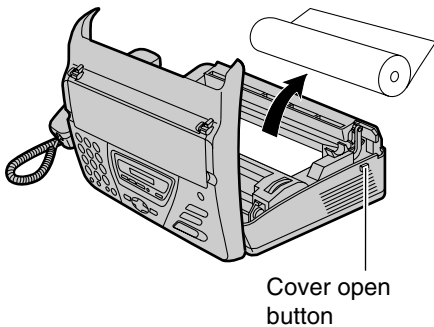

- 3** Clean the thermal head and head cover with a cloth moistened with isopropyl rubbing alcohol, and let all parts dry thoroughly.

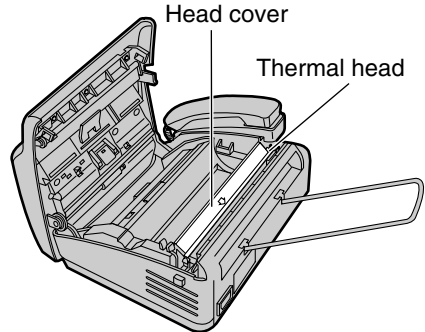

- 4** Connect the power cord and the telephone line cord.

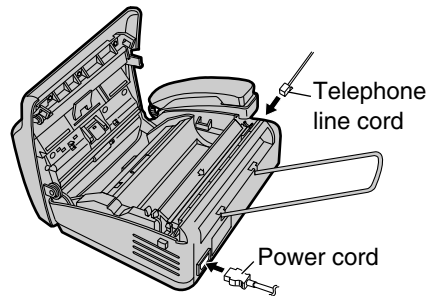

- 5** Install the recording paper and close the cover securely by pushing down on both sides, then press **[FAX/START]** (page 21).

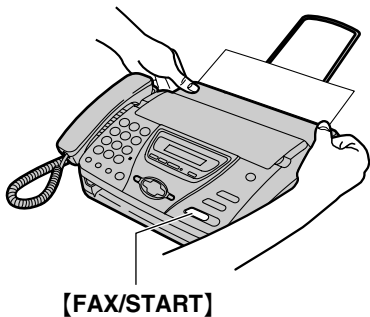

**Caution:**

- To prevent a malfunction due to static electricity, do not use a dry cloth and do not touch the thermal head directly.

## Reference lists and reports

You can print out the following lists and reports for your reference.

### Basic feature list:

provides you with the current settings of the basic programming features (page 70).

### Advanced feature list:

provides you with the current settings of the advanced programming features (page 72).

### Telephone number list:

provides you with names and telephone numbers which are stored in the directory (page 27).

### Journal report:

keeps records of fax transmission and reception. This report will be printed automatically after every 35 fax communications (feature #22 on page 72).

### Caller ID list:

keeps records of the last 20 callers after subscribing to a Caller ID service. This report will be printed automatically after every 20 callers (page 33).

- 3** Press [**◀**] or [**▶**] until the desired item is displayed.

BASIC LIST

ADVANCED LIST

TEL NO. LIST

JOURNAL REPORT

CALLER ID LIST

- 4** Press [**SET**] to start printing.

PRINTING

- To stop printing, press [**STOP**].

- 5** Press [**MENU**].

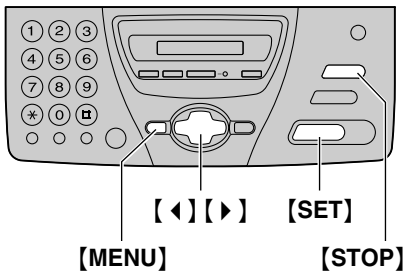

- 1** Press [**MENU**] repeatedly until the following is displayed.

PRINT REPORT

- 2** Press [**SET**].



## Technical data about this product

|   |  |
|---|--|
| <b>Applicable lines:</b>                                  | Public Switched Telephone Network  |
| <b>Document size:</b>                                     | Max. 216 mm in width, Max. 600 mm in length  |
| <b>Effective scanning width:</b>                          | 208 mm   |
| <b>Recording paper size:</b>                              | 216 mm × max. 30 m roll  |
| <b>Effective printing width:</b>                          | 208 mm   |
| <b>Transmission time*<sup>1</sup>:</b>                    | Approx. 15 s/page (Original mode)* <sup>2</sup>  |
| <b>Scanning density:</b>                                  | Horizontal: 8 pels/mm<br>Vertical: 3.85 lines/mm – standard resolution,<br>7.7 lines/mm – fine/photo resolution,<br>15.4 lines/mm – super fine resolution  |
| <b>Photo resolution:</b>                                  | 64-level   |
| <b>Scanner type:</b>                                      | Contact Image Sensor   |
| <b>Printer type:</b>                                      | Thermal Printing   |
| <b>Data compression system:</b>                           | Modified Huffman (MH), Modified READ (MR)  |
| <b>Modem speed:</b>                                       | 9,600 / 7,200 / 4,800 / 2,400 bps; Automatic Fallback  |
| <b>Operating environment:</b>                             | 5 °C – 35 °C, 45% – 85% RH (Relative Humidity)   |
| <b>Dimensions:</b>  | Approx. height 117 mm × width 347 mm × depth 270 mm  |
| <b>Mass (Weight):</b>                                     | Approx. 2.6 kg   |
| <b>Power consumption:</b>                                 | Standby: Approx. 4.5 W<br>Transmission: Approx. 25 W (When sending the ITU-T No. 1 Test Chart)<br>Reception: Approx. 30 W (When receiving the ITU-T No. 1 Test Chart)<br>Copy: Approx. 30 W (When copying the ITU-T No. 1 Test Chart)<br>Maximum: Approx. 125 W (When receiving a 100% black document) |
| <b>Power supply:</b>                                      | 220–240 V AC, 50/60 Hz   |
| <b>Fax memory capacity (KX-FT78 only):</b>                | Approx. 20 pages of document memory (Based on the ITU-T No. 1 Test Chart in standard resolution when no voice messages have been recorded.)  |
| <b>Voice memory capacity (KX-FT78 only)*<sup>3</sup>:</b> | Approx. 20 minutes of recording time including greeting messages when no documents are in memory.  |

# Specifications

- \*1 Transmission speed depends upon the contents of the pages, resolution, telephone line conditions and capability of the other party's machine.
- \*2 Transmission speed is based upon the ITU-T No. 1 Test Chart and original mode. If the capability of the other party's machine is inferior to your unit, the transmission time may be longer.
- \*3 Recording time may be reduced by the calling party's background noise.

## ITU-T No. 1 Test Chart

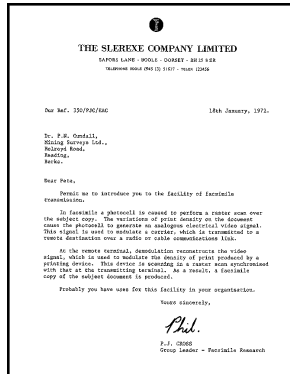

### Note:

- Any details given in these instructions are subject to change without notice.
- The pictures and illustrations in these instructions may vary slightly from the actual product.

---

# Program index

**Basic features**

|   |                |
|---|----------------|
| #01 Date and time .....                             | 22             |
| #02 Your logo.....                                  | 23             |
| #03 Your fax number.....                            | 25             |
| #04 Sending report.....                             | 38, 70         |
| #05 Auto answer.....                                | 70             |
| #06 TAD ring setting .....                          | 57, 70         |
| #07 FAX ring setting .....                          | 70             |
| #09 TEL/FAX ring<br>setting.....                    | 48, 49, 50, 70 |
| #10 Recording time for an incoming<br>message ..... | 71             |
| #11 Remote operation ID .....                       | 71             |
| #13 Dialling mode.....                              | 71             |

**Advanced features**

|                                       |            |
|---------------------------------------|------------|
| #22 Journal report.....               | 38, 72     |
| #23 Overseas mode .....               | 72         |
| #25 Delayed transmission .....        | 72         |
| #26 Caller ID list.....               | 72         |
| #27 Black list .....                  | 53, 72     |
| #30 Silent fax ring setting ....      | 49, 50, 73 |
| #31 Ring detection .....              | 55         |
| #39 Display contrast.....             | 73         |
| #41 Remote fax activation code .....  | 73         |
| #42 Message alert.....                | 73         |
| #43 Recording time alert .....        | 73         |
| #46 Friendly reception.....           | 73         |
| #47 Voice guidance .....              | 74         |
| #49 Auto disconnection .....          | 50, 74     |
| #54 Greeting time.....                | 74         |
| #58 Original mode.....                | 74         |
| #60 Message transfer.....             | 67, 74     |
| #61 Transfer greeting<br>message..... | 67, 74     |
| #67 Incoming message monitor .....    | 74         |
| #70 Pager call .....                  | 54         |
| #76 Connecting tone .....             | 75         |
| #80 Reset advanced features.....      | 75         |

## Index

- A** Accessories ..... 13
  - Paper stacker ..... 19
- Advanced feature list ..... 88
- Advanced features ..... 72
- Alert
  - Message (Feature #42) ..... 73
  - Recording time (Feature #43) ..... 73
- Auto answer setting (Feature #05) .. 70
- Auto disconnection (Feature #49) ..... 50, 74
- B** Basic feature list ..... 88
- Basic features ..... 70
- Black list (Feature #27) ..... 53, 72
- Broadcast transmission ..... 41
- Buttons
  - BROADCAST ..... 41
  - Delete ..... 24
  - DIGITAL SP-PHONE ..... 31
  - ERASE ..... 60, 63
  - HELP ..... 14
  - Insert ..... 24
  - QUICK ..... 62
  - RECEIVE MODE ..... 46, 47, 48, 57
  - REDIAL ..... 37
  - Secret ..... 28
  - SLOW ..... 62
- C** Caller ID ..... 33
- Caller ID list (Feature #26) ..... 33, 72
- Caller's recording time (Feature #10) ..... 71
- Character table ..... 24
- Cleaning ..... 84
- Communication messages ..... 76
- Connecting tone (Feature #76) ..... 75
- Connections ..... 19
- Copy ..... 56
- D** Date and time (Feature #01) ..... 22, 70
- Delayed transmission (Feature #25) ..... 72
- Dialling mode (Feature #13) ..... 71
- Dial lock ..... 34
- Directory
  - Making a phone call ..... 31
  - Selecting characters ..... 24
  - Sending faxes ..... 40
  - Storing ..... 27
- Display
  - Contrast (Feature #39) ..... 73
  - Error messages ..... 77
- Document size ..... 39
- Duplex ring service (Feature #31) ..... 55, 73
- E** Error messages ..... 76, 77
- Extension telephone ..... 49, 50, 51
- F** Fax activation code (Feature #41) ..... 51, 73
- Fax auto redial ..... 40
- Fax number (Feature #03) ..... 25, 70
- FAX ONLY mode ..... 47
- Fax receiving ..... 44
- Friendly reception (Feature #46) ..... 46, 73
- G** Greeting message
  - Message transfer (Feature #61) ..... 67, 74
  - TAD/FAX ..... 57, 58, 60
  - TEL/FAX ..... 49, 50, 58, 60
- I** Incoming message monitor (Feature #67) ..... 74
- J** Jams
  - Document ..... 82
  - Paper ..... 83
- Journal report (Feature #22) ..... 38, 72
- L** Logo (Feature #02) ..... 23, 70
- M** Memory reception ..... 46
- Message alert (Feature #42) ..... 73
- Message transfer (Feature #60) 67, 74
- O** Original mode (Feature #58) ..... 74
- Overseas mode (Features #23) ..... 72

- P** Pager call (Feature #70) ..... 54, 75
  - Polling
    - Receiving ..... 52
    - Transmitting ..... 43
  - Power failure ..... 81
- R** Receiving setting ..... 44
  - Recording
    - Greeting message ..... 58, 67
    - Memo message ..... 61
    - Telephone conversation ..... 32
  - Recording paper ..... 13, 21
  - Recording paper size ..... 89
  - Recording time alert (Feature #43) .73
  - Recording time for
    - TAD/FAX greeting (Feature #54) ..... 74
  - Remote operation card ..... 65
  - Remote operation ID (Feature #11) ..... 71
  - Reports
    - Advanced feature ..... 88
    - Basic feature ..... 88
    - Broadcast sending ..... 41
    - Caller ID ..... 33, 72, 88
    - Journal ..... 38, 72, 88
    - Sending ..... 38, 70
    - Telephone number ..... 88
  - Reset (Feature #80) ..... 75
  - Resolution ..... 37, 56
  - Ring detection (Feature #31) ..... 55, 73
  - Ring setting
    - FAX ONLY (Feature #07) ..... 70
    - Silent fax (Feature #30) ..... 73
    - TAD/FAX (Feature #06) ..... 70
    - TEL/FAX (Feature #09) ..... 70
- S** Sending
  - Broadcast ..... 41, 42
  - Directory ..... 40
  - Manually ..... 37
  - Sending report (Feature #04) ..... 38, 70
  - Set default (Feature #80) ..... 75
  - Storing
    - Directory ..... 27
- T** TAD/FAX mode ..... 57
  - TEL/FAX mode ..... 48
  - TEL mode ..... 46
  - Toll saver ..... 57
- V** Voice contact ..... 36
  - Voice guidance (Feature #47) ..... 74
  - Voice time/day stamp ..... 62
  - Volume ..... 26

**Kyushu Matsushita Electric Co., Ltd.**

1-62, 4-chome, Minoshima, Hakata-ku, Fukuoka 812-8531, Japan

**PFQX1765ZA**

CM0602CY0

## Free Manuals Download Website

<http://myh66.com>

<http://usermanuals.us>

<http://www.somanuals.com>

<http://www.4manuals.cc>

<http://www.manual-lib.com>

<http://www.404manual.com>

<http://www.luxmanual.com>

<http://aubethermostatmanual.com>

Golf course search by state

<http://golfingnear.com>

Email search by domain

<http://emailbydomain.com>

Auto manuals search

<http://auto.somanuals.com>

TV manuals search

<http://tv.somanuals.com>