

Facsimile with Cordless Phone

Quick Reference Guide



KX-PW101CL

Model No. **KX-PW101CL**
KX-PW102CW

KX-PW101CL has one portable handset.
KX-PW102CW has two portable handsets.

Thank you for purchasing a Panasonic facsimile.

Table of Contents

Finding the controls	2
Installations and connections	4
Setting the date and time	8
Setting your facsimile telephone number	8
Setting your logo	9
Character input and command key table	10
Automatic dialing on the main unit	11
Automatic dialing on the portable handset	13
Intercom between the main unit and portable handset	14
Intercom between portable handsets	15
Sending faxes	16
Receiving faxes	18
Operating the built-in answering device	20
Using the hand scanner	21
Individual e-mail services	26
Specifications	Back cover

- This guide explains some basic features and operations, but not all of them. For further details, see the Japanese operating instructions.
- This product is designed for use in Japan. Panasonic cannot provide service for this product if used outside Japan.
- Any details given in this guide are subject to change without notice.

Finding the controls

Main unit (control panel)

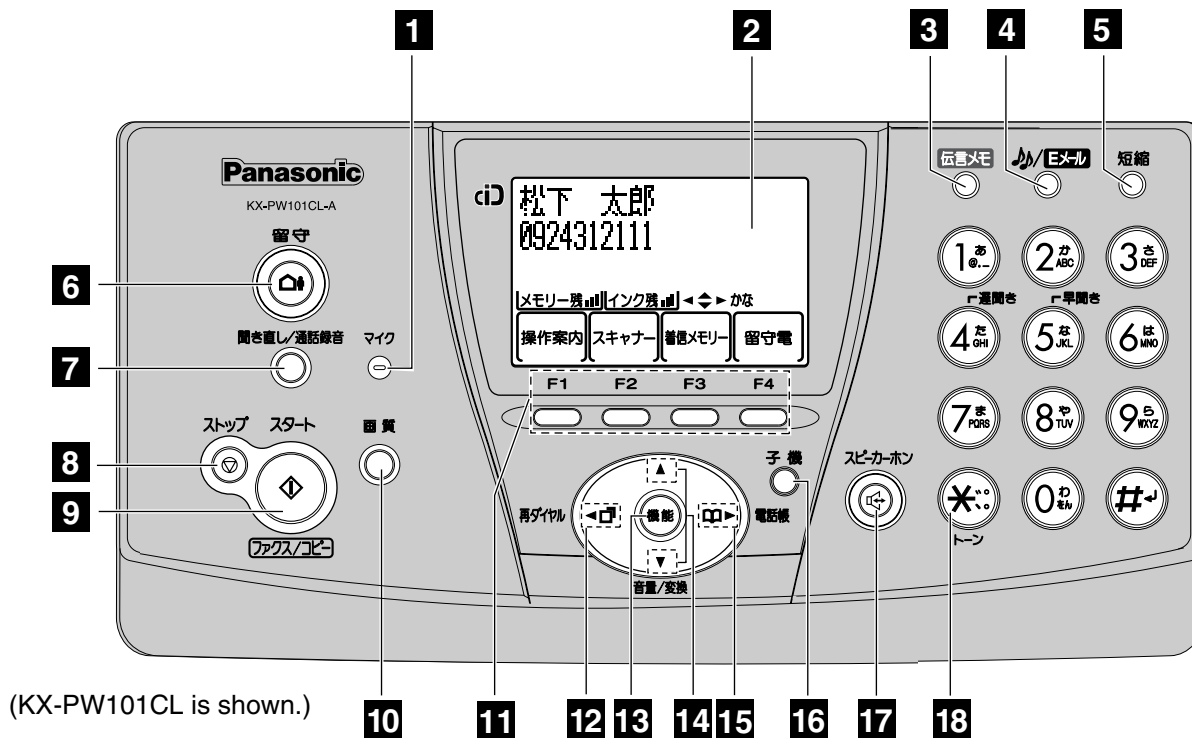

(KX-PW101CL is shown.)

- 1** **Microphone**
- 2** **Liquid crystal display**
- 3** **Memo Message** button & indicator records/plays back a voice memo.
Mute button
- 4** **E-Mail** button & indicator
Pause button
- 5** **Speed Dial** button
- 6** **Auto Answer** button
—light on: answering device activated.
—light off: used as a regular telephone.
- 7** **Replay** button plays back recorded messages. / **Record** button records telephone calls.
- 8** **Stop** button
- 9** **Start/Fax/Copy** button starts faxing or copying.
- 10** **Resolution** button selects the resolution when faxing or copying.
- 11** **Multi-operation** buttons refer to the function displayed on the display panel.
- 12** **Redial** button
- 13** **Function** button initiates programming.
- 14** **Search** button searches the directory by pressing the up and down buttons.
Volume button adjusts ringer, speaker and handset volume by pressing the up and down buttons.
- 15** **Phonebook** button.
- 16** **Portable Handset** button
- 17** **Speakerphone** button
- 18** **Tone** button switches to tone dialing.

Finding the controls

Portable handset

How to use key

再ダイヤル 電話帳
音量/変換



To use the phonebook.



To redial the last number dialed.



To adjust the volume.
To change Hiragana into Kanji.

外線

To make/answer calls.

クリア
内線

To page the main unit or another portable handset.
To clear letters/numbers.

切

To end a call.
To end or exit from editing or other operations.

着信メモリー
保留

To put a call on hold.
To start a search in the Number Display log.

トク

To talk to another portable handset.

キヤッチ

For call waiting service users.

ファクス
めざまし

To receive faxes.

スピーカーホン

To use the speakerphone.

増設

Used when installing additional portable handsets.

Speaker

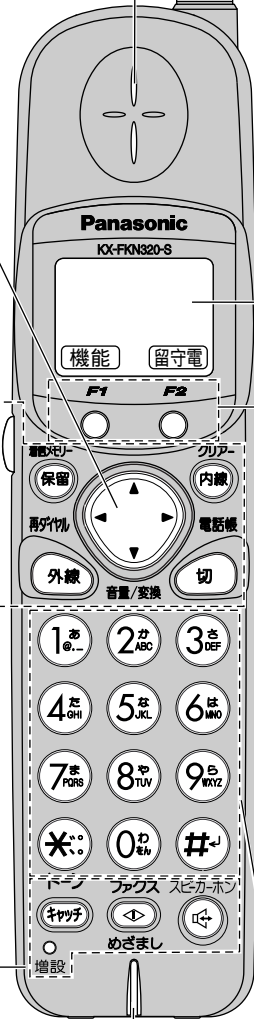

Microphone

(Do not cover the microphone while talking.)

Call/Charge indicator

when receiving a call, the indicator will blink.

when placed on a charger
Charging Apricot (Red)
Full Off

LCD (with back light)

Displays battery strength, telephone numbers etc.

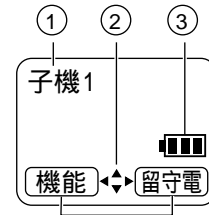

① Portable handset number

② Indicates which directions the

再ダイヤル 電話帳 key can be tilted.

音量/変換

▲ up

◀ left

③ Battery strength

④ Function menu that is controlled by **F1** or **F2**.

How to use **F1** **F2** buttons

F1 and **F2** buttons refer to the function displayed on the bottom of the display. They function differently depending on the mode.

Dial buttons

***** Tone button

トーン To switch to Tone dialing mode.

Sharp button

Hand scanner

Memory indicator (Shows the amount of memory being used)

Battery indicator
(Shows the amount of battery power left)

Operation indicator
(Shows the condition of the scanner)

Delete button

(To delete the last page of scanned content, press for 2 seconds.)

Resolution button

Scanning width button

To start or stop scanning

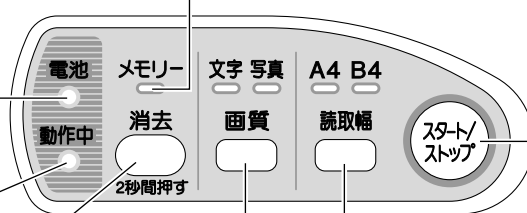

Installations and connections

Installing the ink film

- 1 Open the control panel.

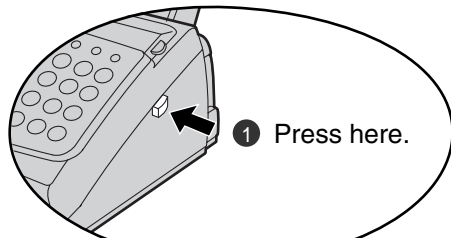

- 2 Open the control panel until it locks.

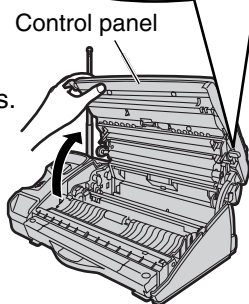

- 2 Insert the ink film.

- 1 Find the "T" shaped gear (blue).

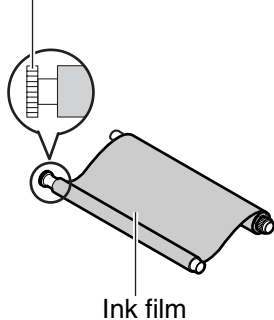

- 2 Insert the blue core into the right slot of the main unit.

- 3 Insert the "T" shaped gear (blue) into the left slot of the main unit.

"T" shaped gear (blue)

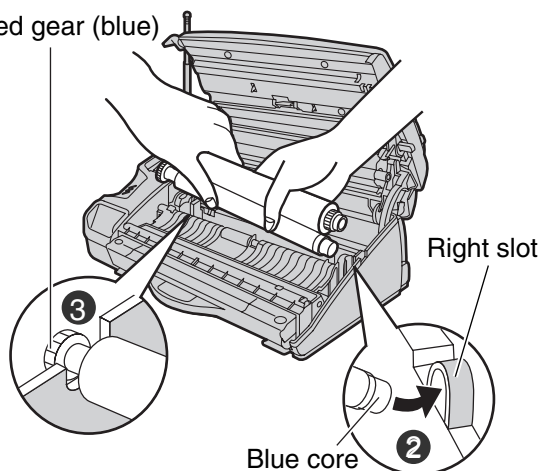

- 4 Insert the white core into the slots shown in the picture below.

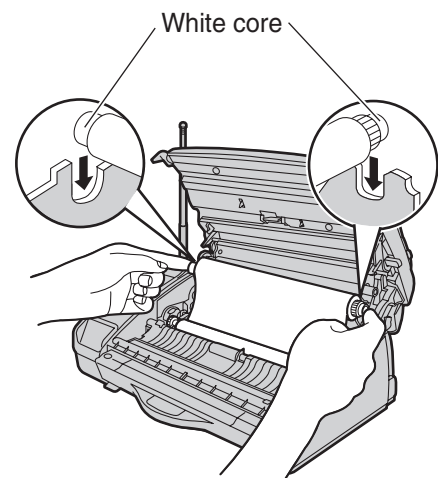

- 5 If the ink film is slack, tighten it by winding the "T" shaped gear.

"T" shaped gear (blue)

Do not be slacken.

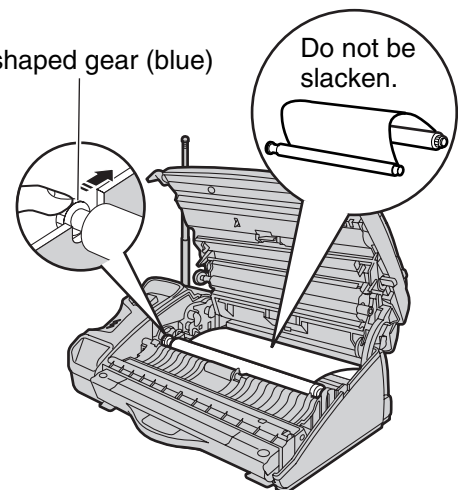

- 3 Close the control panel until it locks.

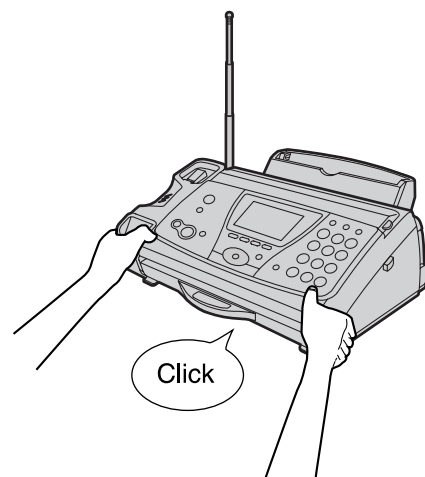

Installations and connections

Installing recording paper (A4 size)

1 Install the recording paper tray.

- 1 Insert the left tab on the recording paper tray into the left slot of the main unit.
- 2 Insert the right tab into the right slot of the main unit.

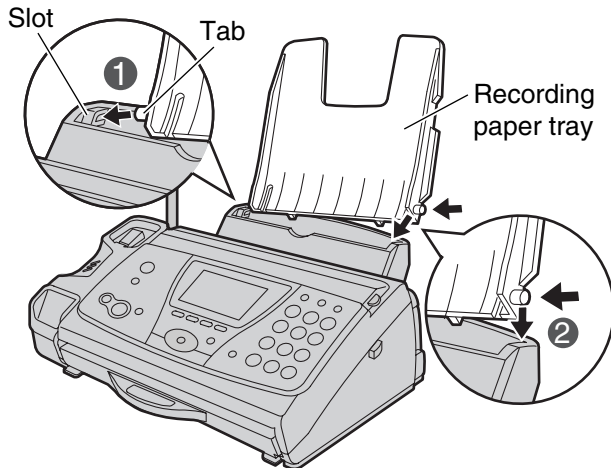

2 Insert the recording paper into the recording paper tray.

- 1 Open the paper entrance cover until it locks.

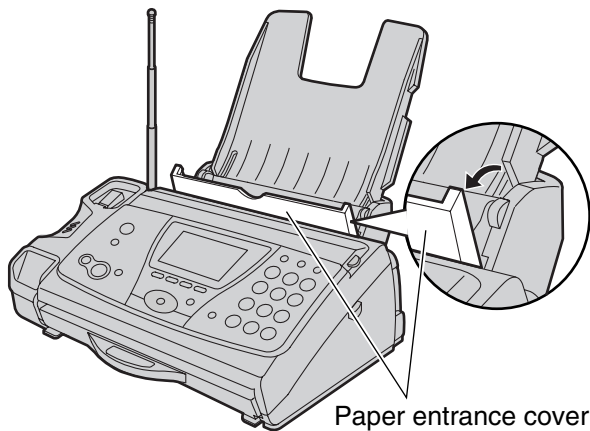

- 2 Fan the stack of recording paper (A4 size).
- 3 Insert the recording paper into the recording paper tray. (Up to 30 sheets)

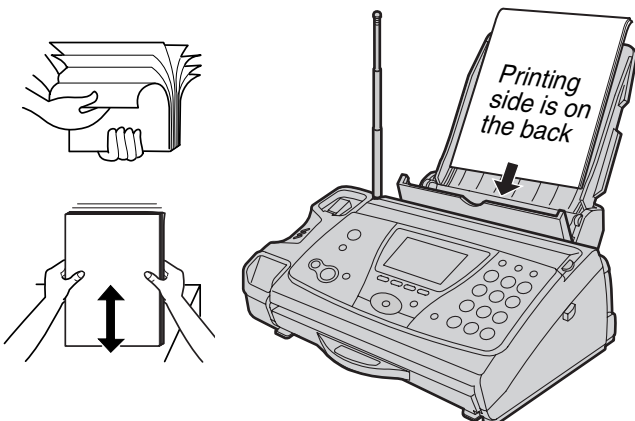

3 Close the paper entrance cover by leaning it back.

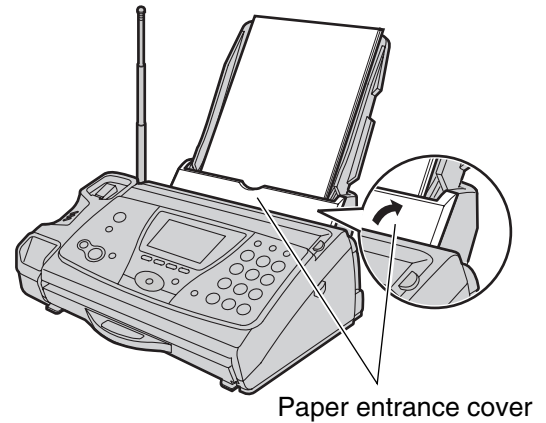

4 Install the recording paper cover on the recording paper tray by sliding it down from the top.

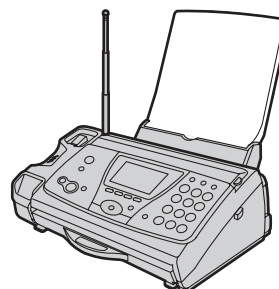
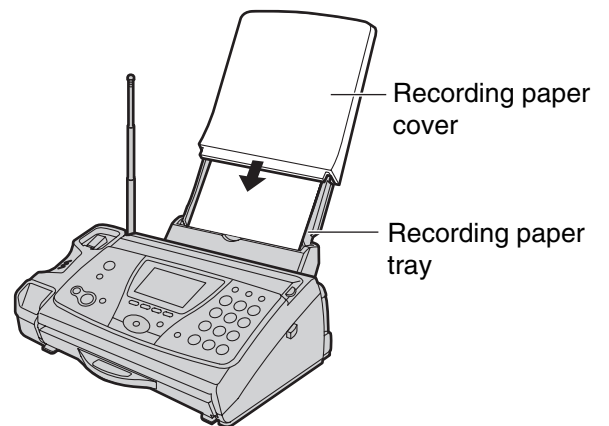

Installations and connections

Setting up the hand scanner

- 1** Press down the knob of the hand scanner, and pull out the hand scanner from the main unit.

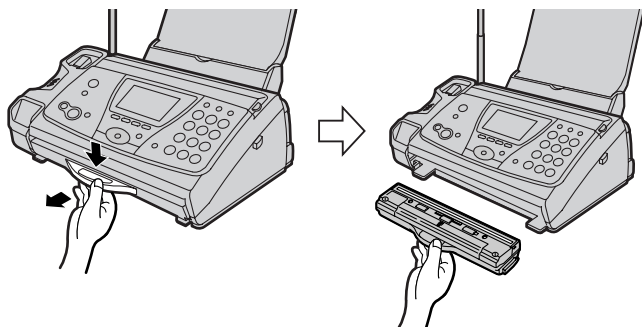

- 2** Slide and open the battery cover by slightly pushing  part.

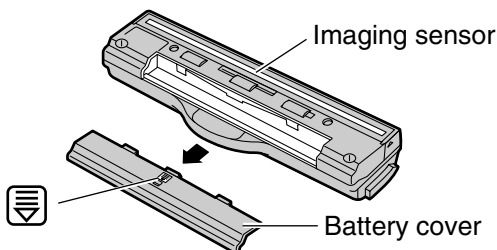

- 3** Connect the battery to the hand scanner, and close the battery cover.

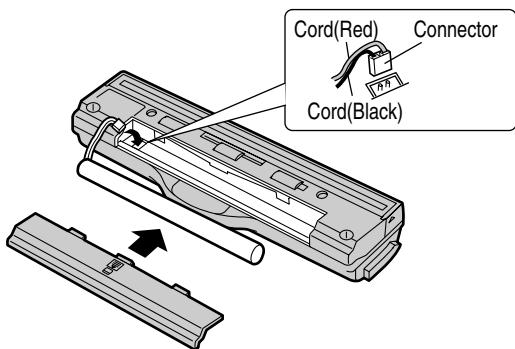

- 4** Insert the hand scanner into the main unit.

- Charge the battery **for 10 hours** after connecting the power cord to the power outlet.

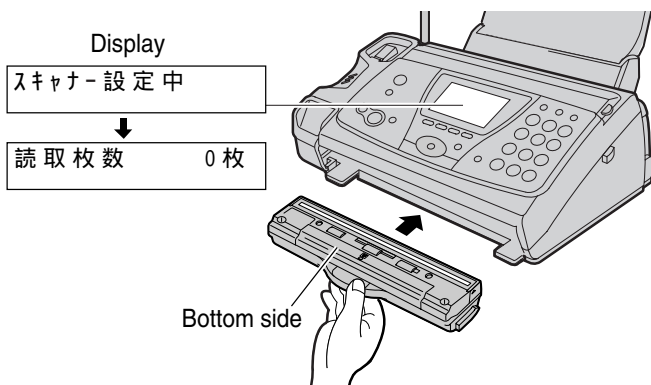

- The hand scanner battery is charged when the hand scanner is inserted into the main unit.

Setting up the portable handset

- 1**
-
- A diagram showing a 'Charger' box with a 'Plug' being inserted into a 'Power outlet (AC 100 V)'. An 'AC adaptor' is connected to the power outlet and the charger.

- 2**
-
- A diagram showing a 'Battery' being inserted into the 'Connector' of a 'Handset'. The 'Battery cover' is then closed, with a 'Click' sound indicated.

- 3** Charge the battery in the charger **for 10 hours**.

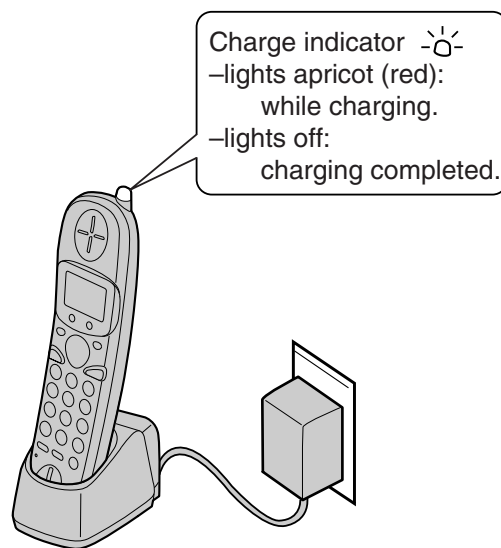

- After your Panasonic battery is fully charged, it will last up to about 7 hours of conversation.

Installations and connections

Connecting the main unit

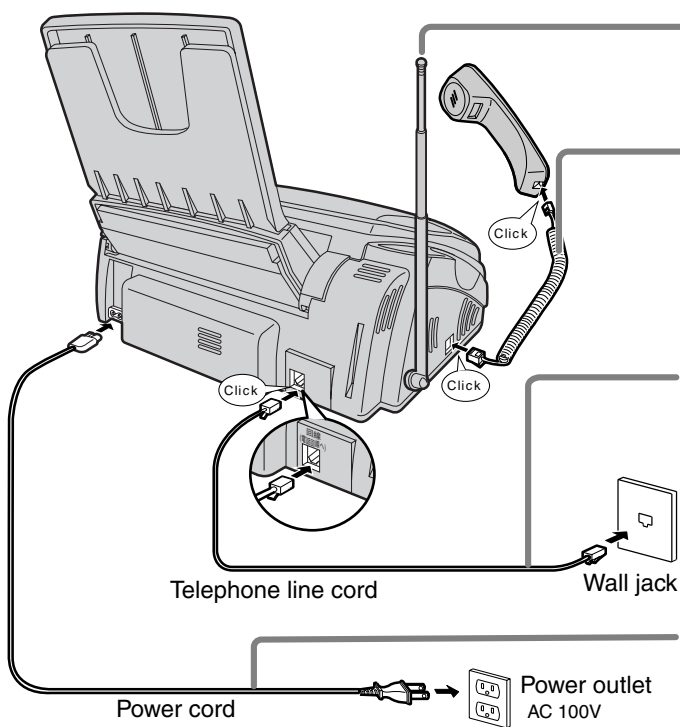

1 Raise the antenna.

2 Connect the cord and place the handset on the main unit.

3 Connect the telephone line cord (Supplied accessory).

4 Connect the power cord.

After the Power On...

This unit will automatically select the dialing mode (Tone/Pulse).

Setting the date and time

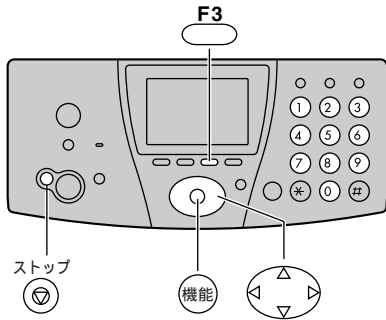

1 Press **機能** (Function).

機能登録モード

2 Press **検索** (Search button) repeatedly until the following is displayed.

最初の設定
呼出音とベル回数
決定は[F3]を押す

3 Press **決定 F3** (Set).

Example :

日付時刻
2002年 01月 01日
00:00

Cursor

4 Enter the correct year/month/day.

Example: February 1, 2002

Press 2 0 0 2 0 2 0 1 .

日付時刻
2002年 02月 01日
00:00

5 Enter the correct hour/minute in a 24-hour clock entry.

Example: 15:45 (3:45 PM)

Press 1 5 4 5 .

日付時刻
2002年 02月 01日
15:45

6 Press **登録 F3** (Register).

登録しました



日付時刻
2002年 02月 01日
15:45

7 Press **ストップ** (Stop).

Example :

2月 1日 15:45
用件録音 00件

Setting your facsimile telephone number

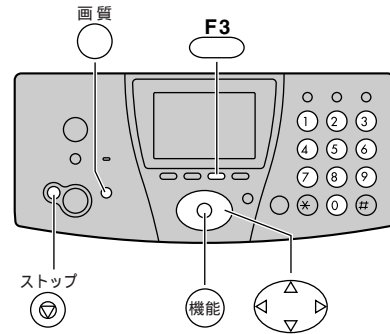

1 Press **機能** (Function).

機能登録モード

2 Press **検索** (Search button) repeatedly until the following is displayed.

最初の設定
呼出音とベル回数
決定は[F3]を押す

3 Press **決定 F3** (Set).

Example :

日付時刻
2002年 02月 01日
15:45

4 Press **検索** (Search button) repeatedly until the following is displayed.

あなたの電話番号？
TEL=

Cursor

5 Enter your facsimile telephone number, up to 20 digits.

Example: 098 765 43 . .

あなたの電話番号？
TEL=98 765 43 . .

The **画質** (Space) button replaces the digit with a space.

6 Press **登録 F3** (Register).

登録しました



あなたの電話番号？
TEL=098 765 43 . .

7 Press **ストップ** (Stop).

Example :

2月 1日 15:45
用件録音 00件

Setting your logo

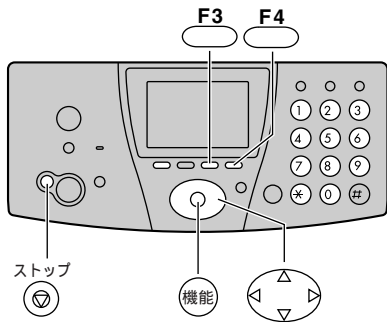

1 Press (Function).

機能登録モード

2 Press (Search button) repeatedly until the following is displayed.

最初の設定
呼出音とヘルプ回数
決定は[F3]を押す

3 Press (Set).

4 Press (Search button) repeatedly until the following is displayed.

名前(印字用)?

Cursor

5 Enter your logo, up to 30 characters, using the dial keypad.

- To enter English characters easily, press (Character input mode) repeatedly and select “英” (English and sign input mode).
- For details, see the table on page 10 for instructions.

Example: Micah

1. Press once.

名前(印字用)?

M

Cursor

2. Press six times.

名前(印字用)?

Mi

3. Press six times.

名前(印字用)?

Mic

4. Press to move the cursor to the next space and press four times.

名前(印字用)?

Mica

5. Press five times.

名前(印字用)?

Micah

6 Press (Register).

登録しました



名前(印字用)?

Micah

> _

7 Press (Stop).

Character input and command key table

Character Dial key	Pressing the dial keys will select a character as shown below.			
	“かな” Hiragana	“カナ” Katakana	“英” English	“数” Numbers
①	あいうえおあいうえお	アイウエオアイウエオ	@ . _ - & \$ ¥ % + = ~ ^	1
②	かきくけこ	カキクケコ	A B C a b c	2
③	さしすせそ	サシスセソ	D E F d e f	3
④	たちつてとっ	タチツテトッ	G H I g h i	4
⑤	なにぬねの	ナニヌネノ	J K L j k l	5
⑥	はひふへほ	ハヒフヘホ	M N O m n o	6
⑦	まみむめも	マミムメモ	P Q R S p q r s	7
⑧	やゆよやゆよ	ヤユヨヤユヨ	T U V t u v	8
⑨	らりるれろ	ラリルレロ	W X Y Z w x y z	9
⑩	わをんー！？()	ワヲンー！？()	! ? / - * # , ; : . ' ” () [] { } 「 」	0
✳	“ ° 、 。		、 。	
Command keys	文字切替 F4 (Main unit), (Portable handset)		Used to change the character input mode.	
	← → (Main unit), ← → (Portable handset)		Used to move the cursor to the left and right.	
	消去 F1 (Main unit), クリア 内線 (Portable handset)		Used to delete a character.	
	画質 ○ (Main unit), (Portable handset)		Used to insert a space.	

- When entering e-mail address, the small letters are displayed before the capital letters.
- When entering e-mail address, you can not enter the following symbols: ` ` ° - ` ` 「 」
- When entering e-mail address, you can enter only English and Numbers.
- When entering e-mail message, pressing (#) enables you to begin the new line. (“↵” is displayed.)
- The display items of the main unit are somewhat different from that of the portable handset.

Automatic dialing on the main unit

Storing names and telephone numbers in the phonebook

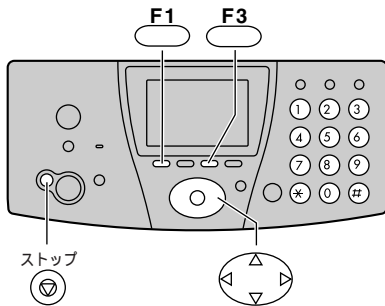

- 1 Press (Phonebook).

電話帳検索
名前？
- 2 Press (Register).
 - “XXX” shows the number of remaining stations you can store.
 - You can program up to 150 stations, including 4 pre-programmed stations.

電話帳空き xxx件

↓

名前？
█
> _
- 3 Enter the name, up to 12 characters (see the table on page 10 for instructions).
- 4 Press (Register) twice.
- 5 Enter the telephone number, up to 30 digits.
 - To correct a mistake, press (Clear).
- 6 Press (Register).
- 7 If necessary, enter the group number (1–9).
- 8 Press (Register).
 - To program other items, repeat steps 3 to 8.
- 9 Press (Stop) to exit the program.

Making a voice call using the phonebook

- 1 Press (Phonebook).
- 2 Press (Search button) repeatedly until the desired name is displayed.
- 3 Lift the handset or press (Speakerphone).

Editing a stored name or number

- 1 Press (Phonebook).
- 2 Press (Search button) repeatedly until the desired name is displayed.
- 3 Press (Edit).
- 4 Edit the name (see the table on page 10 for instructions), then press (Register).
 - If you do not need to edit the name, press (Register) and skip to step 5.
- 5 Enter the correct kana, then press (Register).
 - If you do not need to edit the kana, press (Register) and skip to step 6.
- 6 Enter the correct telephone number, then press (Register).
 - If you do not need to edit the telephone number, press (Register) and skip to step 7.
- 7 If necessary, enter the correct group number.
- 8 Press (Register).

Automatic dialing on the main unit

Storing names and telephone numbers in the speed dialer

You can store up to 9 names and telephone numbers which are stored in the phonebook. The dialling buttons (① to ⑨) function as memory stations.

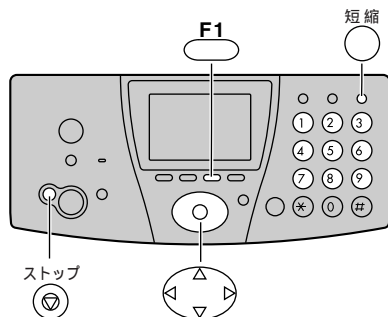

1 Press (Speed dialer).

2 Press the memory station number (① to ⑨).



3 Press (Register).

4 Press repeatedly until desired name is displayed.

5 Press (Register).

- To program other items in other stations, repeat steps 3 to 5.

6 Press (Stop) to exit the program.

Making a voice call using the speed dialer

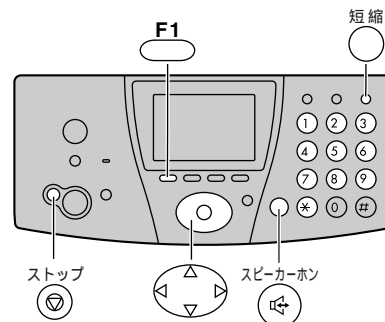

1 Press (Speed dialer).

2 Press the memory station number (① to ⑨).

3 Lift the handset or press (Speakerphone).

Erasing a name and number stored in the speed dialer

1 Press (Speed dialer).

2 Press the memory station number (① to ⑨) which you want to erase.

3 Press (erase).

4 Press .

Automatic dialing on the portable handset

Storing names and telephone numbers in the phonebook

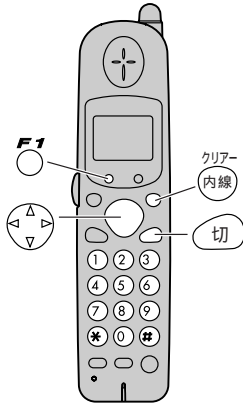

1 Press (Phonebook).

電話帳検索
名前？

2 Press (Register).

- “XXX” shows the remaining station numbers you can store.
- You can program up to 150 stations, including 4 pre-programmed stations.

名前？
■
空き x x x 件

3 Enter the name, up to 12 characters (see the table on page 10 for instructions).

4 Press (Register) twice.

5 Enter the telephone number, up to 30 digits.

- To correct a mistake, press (Clear).

6 Press (Register).

7 If necessary, enter the group number (1–9).

8 Press (Register).

- To program other items, repeat steps 3 to 8.

9 Press (Off) to exit the program.

Making a voice call using the phonebook

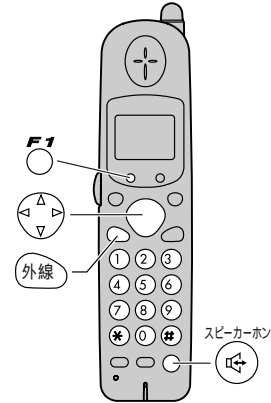

1 Press (Phonebook).

2 Press repeatedly until the desired name is displayed.

3 Press (Talk) or press (Speakerphone).

Editing a stored name or number

1 Press (Phonebook).

2 Press repeatedly until the desired name is displayed.

3 Press (Edit).

4 Edit the name (see the table on page 10 for instructions), then press (Register).

- If you do not need to edit the name, press (Register) and skip to step 5.

5 Enter the correct kana, then press (Register).

- If you do not need to edit the kana, press (Register) and skip to step 6.

6 Enter the correct telephone number.

- If you do not need to edit the telephone number, skip to step 7.

7 Press (Register).

8 If necessary, enter the correct group number.

9 Press (Register).

Intercom between the main unit and portable handset

An intercom is available between the main unit and portable handset.

Using the main unit:

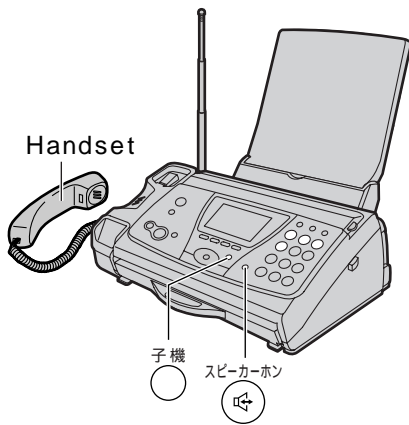

1 ■ For single portable handset users

- Lift the handset. 子機
 - When pressing 子機 (Portable handset) instead of lifting the handset, you can use the speakerphone. Skip to step 2.

番号 ?

- Press 子機 (Portable handset).

子機 1呼出中

■ For multiple portable handset users

- Lift the handset, then press 子機 (Portable handset).
 - When pressing 子機 (Portable handset) instead of lifting the handset, you can use the speakerphone. Skip to step ②.
- Press the portable handset number (① to ④) which you want to call.

2 Start talking after the unit sounds "Pi peep" and shows the following.

子機 1内線通話中

3 Replace the handset or press スピーカーホン (Speakerphone) if using the speakerphone.

Using the portable handset:

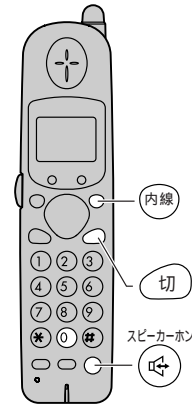

1 ■ For single portable handset users

Press 内線 (Intercom).

内線呼出

■ For multiple portable handset users

Press 内線 (Intercom), then press ①.

2 Start talking after the unit sounds "Pi peep" and shows the following.

- You can switch to the speakerphone by pressing

内線通話中

スピーカーホン スピーカーホン (Speakerphone).

3 Press 切 (Off) to end the intercom call.

Intercom between portable handsets

A 2-way intercom is available between 2 portable handsets.
 (For KX-PW101CL users: An optional handset is needed when using this feature.)

Making an intercom call

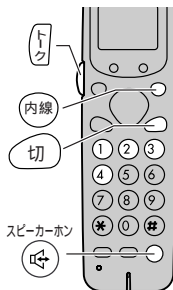

- 1 Press **内線** (Intercom) and the desired portable handset number (**1** to **4**).



子機間呼出

↓
 子機間通話

- 2 Start talking.

1. Press and hold **ト** (Talk) until a beep sounds.

- スピーカーホン
 light on

2. Start talking while holding down **ト** (Talk).

- Keep holding down **ト** (Talk) until you finish talking.



子機間通話
 [送話]

3. Release **ト** (Talk) after you finish talking.

子機間通話

- 3 Listen to the response.



子機間通話
 [受話]



子機間通話

- 4 If you want to continue the conversation, repeat steps 2 and 3.

- 5 Press **切** (Off) to end the intercom call.

Answering an intercom call

1



子機間着信



子機間通話

- 2 Listen to the caller.



子機間通話
 [受話]



子機間通話

- 3 Respond to the caller.

1. Press and hold **ト** (Talk) until a beep sounds.

- スピーカーホン
 light on

2. Start talking while holding down **ト** (Talk).

- Keep holding down **ト** (Talk) until you finish talking.



子機間通話
 [送話]

3. Release **ト** (Talk) after you finish talking.

子機間通話



- 4 If you want to continue the conversation, repeat steps 2 and 3.

- 5 Press **切** (Off) to end the intercom call.

Sending faxes

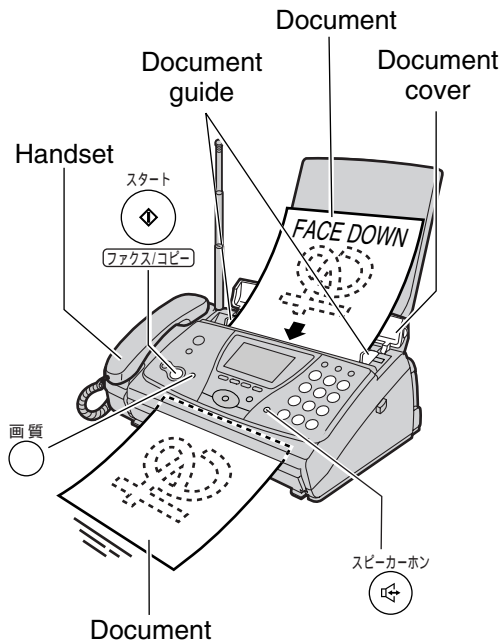



Sending a fax manually

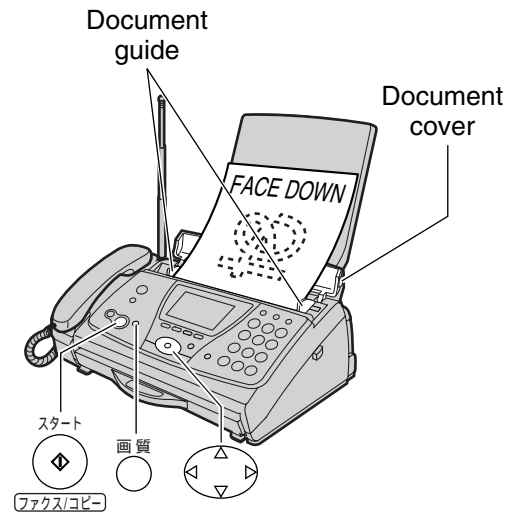

- 1 Open the document cover, and adjust the width of the document guides to the size of the document.
- 2 Insert the document (up to 5 pages) FACE DOWN until a single beep is heard.
- 3 If necessary, press  (Resolution) repeatedly to select the desired setting (see below).
- 4 Lift the handset or press  (Speakerphone).
- 5 Dial the fax number.
- 6 When a fax tone is heard, press  (Fax).
- 7 Replace the handset if you are using it.
 - The unit will start fax transmission.

Sending a fax using the phonebook



- 1 Open the document cover, and adjust the width of the document guides to the size of the document.
- 2 Insert the document (up to 5 pages) FACE DOWN until a single beep is heard.
- 3 If necessary, press  (Resolution) repeatedly to select the desired setting (see below).
- 4 Press  (Phonebook).
- 5 Press  (Search button) until the desired name is displayed.
- 6 Press  (Fax).
 - The unit will start fax transmission.

To select the resolution

Select the desired resolution according to the type of document, by pressing  (Resolution).

画質 = ふう (Standard) for printed or typewritten originals with normal-sized characters.



画質 = 小さい (Fine) for originals with minute printing.

画質 = 写真 (Photo) for originals containing photographs.

Sending faxes

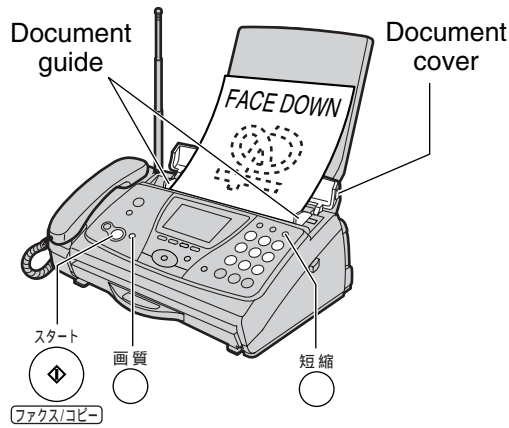
Sending a fax using the speed dialer



- 1** Open the document cover, and adjust the width of the document guides to the size of the document.
- 2** Insert the document (up to 5 pages) FACE DOWN until a single beep is heard.
- 3** If necessary, press  (Resolution) repeatedly to select the desired setting.
- 4** Press  (Speed dialer).
- 5** Press memory station number (① to ⑨).
- 6** Press  (Fax).
 - The unit will start fax transmission.

Receiving faxes

Receiving a fax manually (AUTO ANSWER off)

Using the main unit:

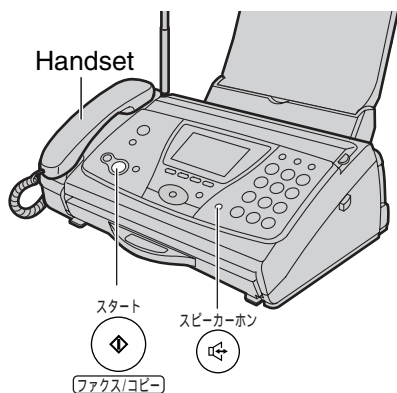

1 When you hear a ring, lift the handset or press (Speakerphone) to answer the call.

2 When:
 – document reception is required,
 – a fax calling tone (slow beep) is heard, or
 – no sound is heard,
 press (Fax).

3 Replace the handset if you are using it.
 • The unit will start fax reception.

Using the portable handset:

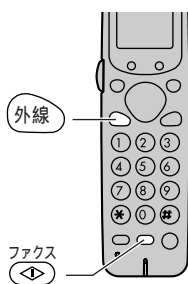

1 When you hear a ring, lift the portable handset from the charger to answer the call.
 • If the portable handset is not set on the charger, press (Talk).

2 When:
 –document reception is required,
 –a fax calling tone (slow beep) is heard, or
 –no sound is heard,
 press (Fax reception).
 • The main unit will start fax reception.

Setting ANSWER mode

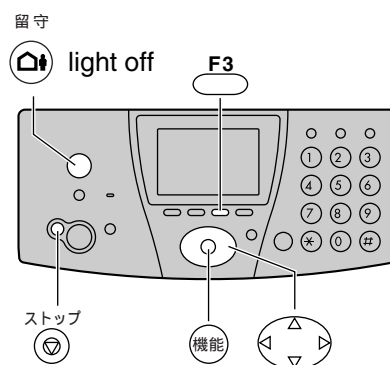

If the (Auto answer) light is on, turn it off by pressing .

When AUTO ANSWER mode is off, the unit provides two types of receiving modes: “電話優先” (Telephone) mode and “ファクス優先” (Fax/Telephone) mode.

Telephone mode (電話優先) –Pre-selected setting:
 Select this mode when you plan to answer the calls yourself.
 When receiving calls, you have to answer all calls manually.

Fax/Telephone mode (ファクス優先):
 Select this mode when you are near the unit and want to use it to receive voice calls yourself and fax calls automatically.

Change the setting if you want to use this mode.

- Press (Function).
- Press (Search button) repeatedly until the following is displayed.
- Press (Set).
- Press (Search button) repeatedly to select the desired mode.

ファクスの受け方を変更
 ファクスの設定
 決定は[F3]を押す

means
 “Telephone mode”
 在宅=電話優先
 選択は[◀▶]を押す

means
 “Fax/Telephone mode”
 在宅=ファクス優先
 選択は[◀▶]を押す

- Press (Register).
- Press (Stop).

Receiving faxes

Receiving a fax automatically (AUTO ANSWER on)

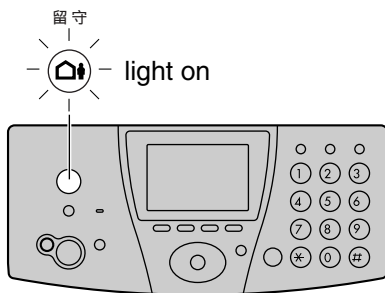

- 1 If the **留守** (Auto answer) light is off, turn it on by pressing **留守**.
- 2 When receiving a call, the unit will receive a fax document or record a voice message automatically depending on the caller's request.

Recording your own greeting message

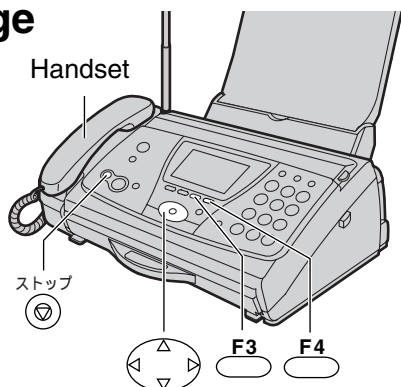

You can record your own greeting message. When receiving a call, it will be played to callers instead of the pre-recorded Japanese greeting message.

- 1 Press **留守電 F4** (Record).
- 2 Press **検索** (Search button) repeatedly until the following is displayed.

自作応答録音
 自作応答消去
 決定は[F3]を押す
- 3 Press **決定 F3** (Set).
- 4 Lift the handset.
- 5 Press **決定 F3** (Set) and record your greeting message, up to 16 seconds, using the handset.
- 6 Press **ストップ** (Stop).
- 7 Replace the handset.
 - Your greeting message will be played back automatically.

Setting AUTO ANSWER mode

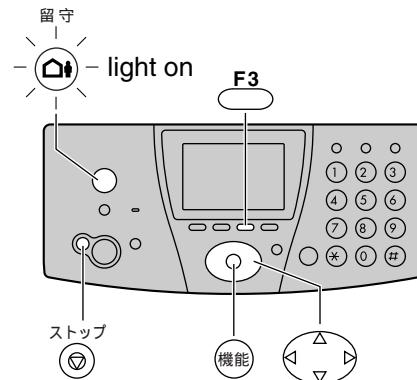

AUTO ANSWER mode will work when the **留守** (Auto answer) light is on.

AUTO ANSWER mode provides three types of receiving modes: “ファクス / 留守電” (Fax/Answering device) mode, “ファクス専用” (Fax only) mode and “留守電専用” (Answering device only) mode.

Fax/Answering device mode (ファクス / 留守電)

–Pre-selected setting:

Select this mode when you want to receive all voice and fax calls automatically.

Fax only mode (ファクス専用):

Select this mode when you wish to use the unit only as a fax machine.

Answering device only mode (留守電専用):

Select this mode when you wish to use the unit only as a telephone answering device.

Change the setting if you want to use the fax only mode or answering device only mode.

1. Press **機能** (Function).
2. Press **検索** (Search button) repeatedly until the following is displayed.

ファクスの受け方を変更
 ファクスの設定
 決定は[F3]を押す
3. Press **決定 F3** (Set).
4. Press **検索** (Search button) repeatedly until the following is displayed.

留守 = ファクス / 留守電
 選択は[◀▶]を押す
5. Press **検索** (Search button) repeatedly to select the desired receiving mode.
6. Press **登録 F3** (Register), then press **ストップ** (Stop).

Operating the built-in answering device

Activating the answering device

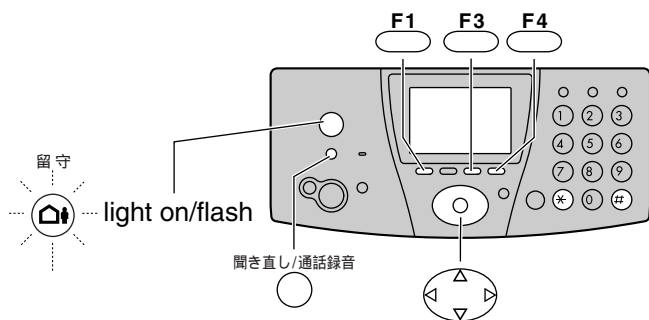

- 1 Turn the **留守** (Auto answer) light on by pressing **留守**.
- 2 When receiving a call, a greeting message will be played and the unit will record a voice message.
 - To record your own greeting message, see page 19.

Listening to recorded messages

When new messages are recorded, the **留守** (Auto answer) light will flash.

Press **留守** to listen to recorded messages. After the messages are played back, the following will be displayed.

- To erase the messages, push *****. 再生した用件を消去する=* しない=#
- To save the messages, push **#**.

Listening to all of the recorded messages

Press **聞き直し/通話録音** (Replay/Record).

After the message are played back, the following will be displayed.

- To erase the messages, push *****. 再生した用件を消去する=* しない=#
- To save the messages, push **#**.

Erasing a specific message

Press **消去 F1** (Erase) while listening to the message you want to erase, then press *****.

Erasing all of the recorded messages

- 1 Press **留守電 F4** (Record).
- 2 Press **決定 F3** (Set), then press *****.

Erasing your own greeting message

- 1 Press **留守電 F4** (Record), then press **検索** (Search button) repeatedly until the following is displayed.

自作応答消去
用件全消去
決定は[F3]を押す

- 2 Press **決定 F3** (Set), then press *****.
 - The pre-recorded Japanese greeting message will be played when you receive a call.

Operating the answering device from a remote location

Preparation: Programming the remote operation ID

1. Press **機能** (Function).
2. Press **検索** (Search button) repeatedly until the following is displayed.

留守番電話の設定
ナンバー・ディスプレイ
決定は[F3]を押す

3. Press **決定 F3** (Set).
4. Enter any 4-digit number (remote operation ID) except * or #.
5. Press **登録 F3** (Register).
6. Press **ストップ** (Stop).

Operation: Listening to a recorded message from a remote location

Turn the **留守** (Auto answer) light on before you go out. Remote operations are available only from a touch tone telephone.

1. Call your unit.
2. Enter the remote operation ID during the greeting message.
3. Press **2** or wait 4 seconds.
 - Only the new recorded messages will be played back.
 - To listen to all the recorded messages, press **4** after the new messages have been played back.

Using the hand scanner

Scanning a document

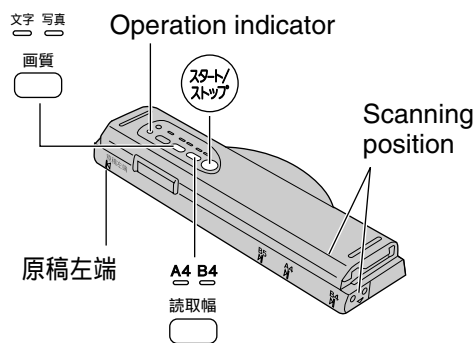

- 1** Press down the knob of the hand scanner, and pull out the scanner from the main unit. Then, turn it over.

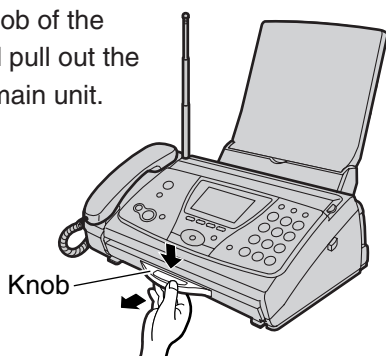

- 2** Press (Resolution) repeatedly to select the desired resolution.

- Resolution types
 - 文字 (Letter: For documents that consist of letters)
 - 写真 (Photo: For documents containing photographs, etc.)

- 3** Press (Scanning width) repeatedly to select the desired width.

- Scanning width types
 - A4 (Within 208mm)
 - B4 (Within 252mm)

- 4** Place the scanning position and the 原稿左端 (Document's left end) on the document.

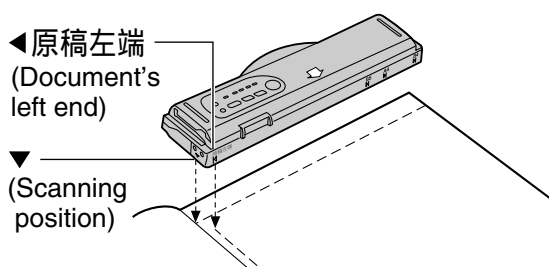

- 5** Press (Start/Stop).

- You will hear a beep, and the operation indicator will light green after about 1 or 2 seconds. You can start scanning after the operation indicator lights green.

- 6** Press the hand scanner against the document, and move it slowly towards the direction of the arrow (⇩).

- When it is scanning properly, the operation indicator will flash green.
- For the proper scanning speed for different resolution types, see “Scanning speed and memory capacity” on the bottom of this page.

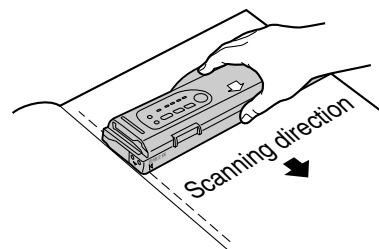

- 7** After scanning the document, press (Start/Stop).

- 8** Insert the hand scanner in the main unit.

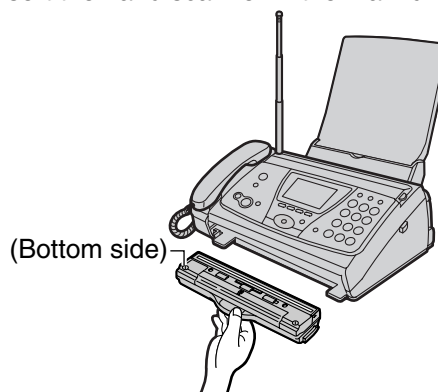

The number of scanned pages is displayed.

読取枚数	枚
印字は[F3]を押す	

Scanning speed and memory capacity

When the (Letter) indicator lights on, the resolution type automatically changes according to the scanning speed.

Resolution indicator	Scanning speed	Resolution type	Memory capacity
文字 <input type="radio"/> (Letter) light on	50mm/ 1 sec	Fine	Approx. 10 pages (document paper size- A4, 700 letters)
	100mm/ 1 sec	Standard	Approx. 20 pages (document paper size- A4, 700 letters)
写真 <input type="radio"/> (Photo) light on	25mm/ 1 sec	-	Approx. 1 page (document paper size- A4, photo)

Using the hand scanner

Operation indicator and warning beep

When scanning documents, check the operation indicator light.

Operation Indicator	Warning Beep	Situation
Green light Slow flash	No beep	The document is being scanned properly. (Fine letter mode)
Green light Fast flash	No beep	The document is being scanned properly. (Standard letter mode)
Green light ON	No beep	The hand scanner has temporarily stopped during scanning. You did not move the hand scanner for more than 30 seconds, so it has stopped scanning automatically.
Red light ON	No beep	The hand scanner is being moved quickly. (The document is being scanned.)
Red light ON	1 beep	The hand scanner is being moved too quickly. (Some parts of the document may not be scanned, or the scanned contents may be too compressed.)
Light OFF	3 beeps	The scanner memory is full. (The memory indicator green light will flash fast.)
		You have scanned a document that is more than 1.5 m in length as 1 page. Scan the document as 2 pages or more.
Light OFF	No beep	The scanner is not in operation.

Memory indicator

Shows the amount of scanner memory being used.

Memory indicator (green light)	Memory used
OFF	0%
ON	~ 66%
Flash slow	~ 99%
Flash fast	100%

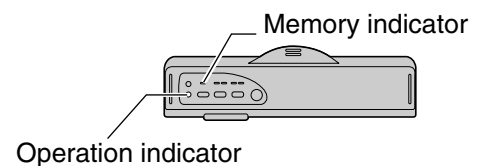

Using the hand scanner

Printing all pages of scanned content

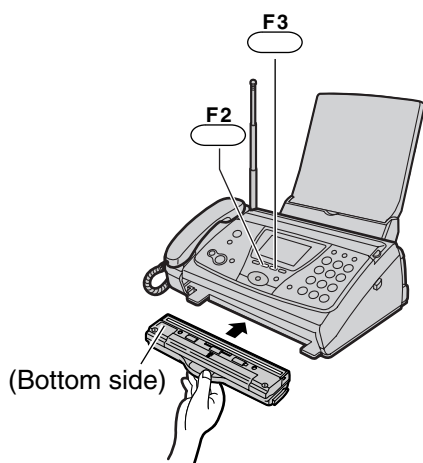

- 1 Insert the hand scanner in the main unit or press スキャナー **F2** (Scanner) when the hand scanner is in the main unit.

The number of scanned pages is displayed.

Example: 10 pages 読取枚数 10枚
印字は[F3]を押す

- 2 Press 決定 **F3** (Set).

等倍=A4 A4
選択は[◀▶]を押す

- 3 Press 決定 **F3** (Set).

印字中 1枚目

Printing a specific page of scanned content

- 1 Insert the hand scanner in the main unit or press スキャナー **F2** (Scanner) when the hand scanner is in the main unit.

The number of scanned pages is displayed.

Example: 10 pages 読取枚数 10枚
印字は[F3]を押す

- 2 Press  (Search button) repeatedly until the following is displayed.

^°-シ° 指定印字
一括消去
決定は[F3]を押す

- 3 Press 決定 **F3** (Set).

開始^°-シ°=01
[数字]を押す

- 4 Enter the number of the first page that you want to print using 2 digits.

Example: page 7 開始^°-シ°=07
[数字]を押す

- To correct a mistake, press 消去 **F1** (Clear).

- 5 Press 決定 **F3** (Set).

終了^°-シ°=07
[数字]を押す

- 6 Enter the number of the last page that you want to print using 2 digits.

Example: page 10 終了^°-シ°=10
[数字]を押す

- To correct a mistake, press 消去 **F1** (Clear).

- 7 Press 決定 **F3** (Set).

等倍=A4 A4
選択は[◀▶]を押す

- 8 Press 決定 **F3** (Set).

- Printing will start.

印字中 7枚目

Using the hand scanner

Fax sending all pages of scanned content

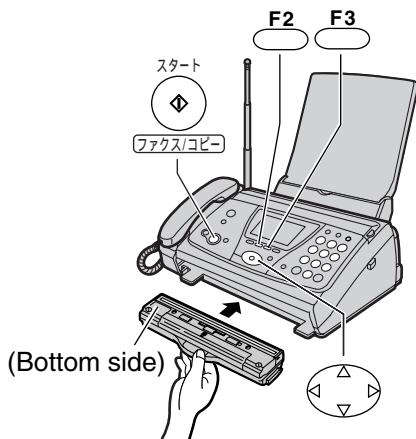

- 1 Insert the hand scanner in the main unit or press **スキャナー F2** (Scanner) when the hand scanner is in the main unit.

The number of scanned pages is displayed.

Example: 10 pages 読取枚数 10枚
印字は[F3]を押す

- 2 Press **◀▶** (Search button) repeatedly until the following is displayed.

一括送信
^°-ジ°指定送信
決定は[F3]を押す

- 3 Press **決定 F3** (Set).

番号 ?

- 4 Dial the fax number.

Example: 09876543.. 09876543..

- 5 Press **スタート** (Fax).

• The unit will start fax transmission.

スキャナー-送信 1枚目

Fax sending a specific page of scanned content

- 1 Insert the hand scanner in the main unit or press **スキャナー F2** (Scanner) when the hand scanner is in the main unit.

- 2 Press **◀▶** (Search button) repeatedly until the following is displayed.

^°-ジ°指定送信
一括印字
決定は[F3]を押す

- 3 Press **決定 F3** (Set).

開始 ^°-ジ° = 01
[数字]を押す

- 4 Enter the number of the first page that you want to send using 2 digits.

Example: page 7 開始 ^°-ジ° = 07
[数字]を押す

• To correct a mistake, press **消去 F1** (Clear).

- 5 Press **決定 F3** (Set).

終了 ^°-ジ° = 07
[数字]を押す

- 6 Enter the number of the last page that you want to send using 2 digits.

Example: page 10 終了 ^°-ジ° = 10
[数字]を押す

• To correct a mistake, press **消去 F1** (Clear).

- 7 Press **決定 F3** (Set).

番号 ?

- 8 Dial the fax number.

Example: 09876543.. 09876543..

- 9 Press **スタート** (Fax).

• The unit will start fax transmission.

スキャナー-送信 7枚目

Using the hand scanner

Deleting all pages of scanned content

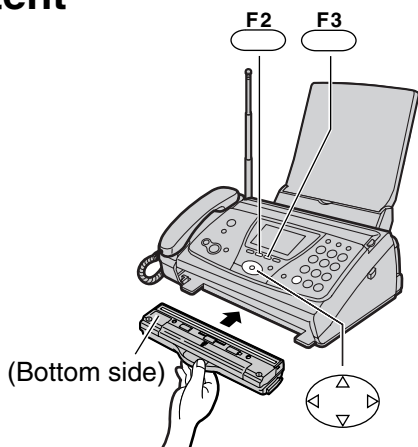

- 1 Insert the hand scanner in the main unit or press **スキャナー F2** (Scanner) when the hand scanner is in the main unit.

The number of scanned pages is displayed.

Example: 10 pages 読取枚数 10枚
印字は[F3]を押す

- 2 Press **◀▶** (Search button) repeatedly until the following is displayed.

一括消去
^°-シ° 指定消去
決定は[F3]を押す

- 3 Press **決定 F3** (Set).

すべて消去しますか?
はい=* いいえ=#

- 4 Press *****.
• Deleting will start.

消去しました



読取枚数 0枚

Deleting the last page of scanned content

- 1 Press **消去** (Erase) until a beep is heard (Approx. 2 seconds).
• The last page will be deleted.

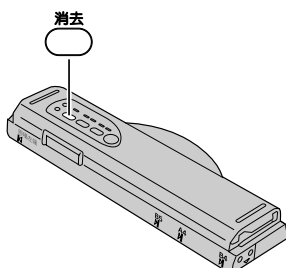

Deleting a specific page of scanned content

- 1 Insert the hand scanner in the main unit or press **スキャナー F2** (Scanner) when the hand scanner is in the main unit.

- 2 Press **◀▶** (Search button) repeatedly until the following is displayed.

^°-シ° 指定消去
一括送信
決定は[F3]を押す

- 3 Press **決定 F3** (Set).

開始 ^°-シ° =01
[数字]を押す

- 4 Enter the number of the first page that you want to delete using 2 digits.

Example: page 7 開始 ^°-シ° =07
[数字]を押す

- To correct a mistake, press **消去 F1** (Clear).

- 5 Press **決定 F3** (Set).

終了 ^°-シ° =07
[数字]を押す

- 6 Enter the number of the last page that you want to delete using 2 digits.

Example: page 10 終了 ^°-シ° =10
[数字]を押す

- To correct a mistake, press **消去 F1** (Clear).

- 7 Press **決定 F3** (Set).

消去しますか?
はい=* いいえ=#

- 8 Press *****.
• Deleting will start.

消去しました



Example: 読取枚数 6枚
印字は[F3]を押す

Individual e-mail services

Using the e-mail services

Kyushu Matsushita Electric Co., Ltd. (hereafter called "KME") offers individual information services, such as e-mail.

Your fax machine with e-mail features will enable you to send an e-mail to another party's personal computer (PC) or another e-mail fax machine anywhere in the world through the Internet. Also, you will be able to receive an e-mail from them.

To access the Internet using your fax machine,

- you need a credit card (VISA, JCB or MASTER as of February 2002) and
- have to subscribe to individual information services offered by KME beforehand.

The application fee including call charges will be charged to your Credit Card.

Important:

- If your fax machine is connected to a home telephone system or a private branch exchange (PBX) system, these services are not available.

Application fee and call charges

KME information services	Registration fee	¥500
	Information Service fee (Call charge included)	¥20/minute (8 am-11 pm) ¥18.5/minute (11 pm-8 am)
	Melody download service "Yumekara" fee	¥50/a melody

- As of February 2002.
- Tax not included.

KME information services

The following services are available with your fax machine. The information service fee including the call charge will be applied.

- E-mail reception and printing (page 28)
- Voice e-mail listening (page 28)
- Text e-mail sending (page 29)
- Fax e-mail sending (page 29)
- Voice e-mail sending (page 30)
- Storing another party's e-mail address (free of charge) (page 31)
- Others

Note:

- KME plans to add new information services and the information service fee is subject to change. KME will announce them by e-mail to its customers.
- For the PC user to view your fax e-mail or to hear your voice e-mail sent from your fax machine, the following PC software will be required.
 - E-mail software that can read the MIME format
 - TIFF viewer software
 - WAV sound player software and sound system

Individual e-mail services

Subscribing to KME information services

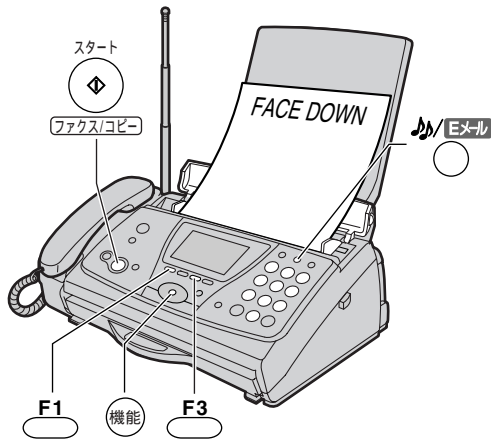

1 Fill in the included application form.

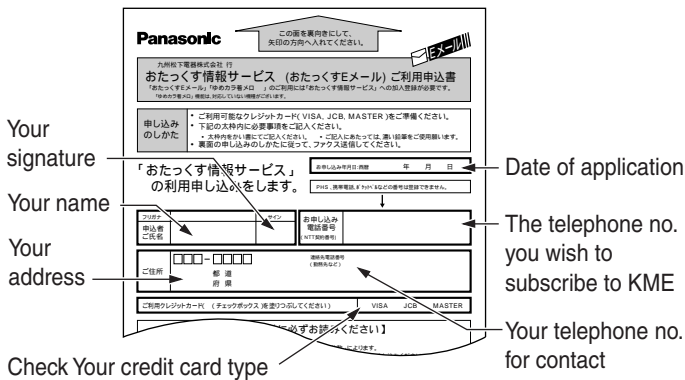

2 Press **機能** (Function), then press **Eメール** (E-mail).

3 Press **F3** (Set).

4 Enter your 16-digit credit card number.

- To correct a mistake, press **F1** (Clear).

5 Press **F3** (Set).

6 Enter your credit card number again, then press

F3 (Set).

7 Enter the valid date of your credit card.

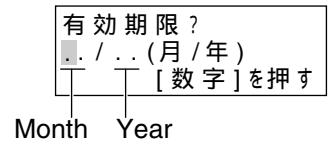

8 Press **F3** (Set).

9 Insert the application form FACE DOWN.

10 Press **F3** (Set).

- The unit will start fax transmission.

11 After approx. 5 minutes, the unit will ring, and a data communication will start automatically between your unit and KME.

- If you answer this call, hang up and wait for a while until the communication is completed.

12 When the communication is completed, a user registration form will be printed.

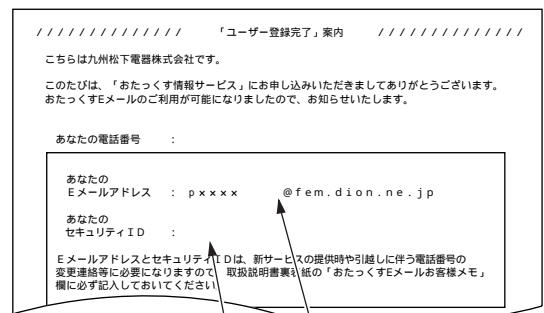

- Please save the address and ID code for future reference.

13 Press **Eメール** (E-mail).

14 Press **F3** (Set) twice.

- An information service guide will be printed.

Individual e-mail services

Receiving and printing an e-mail

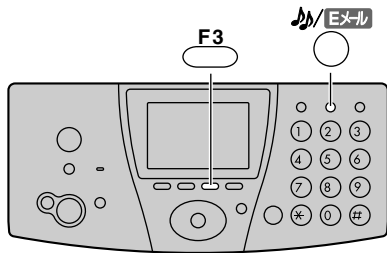

1 Press (E-mail), then press (Set).

2 Press (Set).

- If there is an e-mail you have not viewed yet, the unit will print the received e-mail.

- If there is no e-mail, the following will be displayed.

未受信Eメール 0件

The file formats recognized by your fax machine are:

- JPEG • ~. doc
- TIFF • ~. xls
- BMP • ~. ppt
- TXT • ~. pdf
- WAV

(as of February 2002)

Listening to a received voice e-mail in an attached file

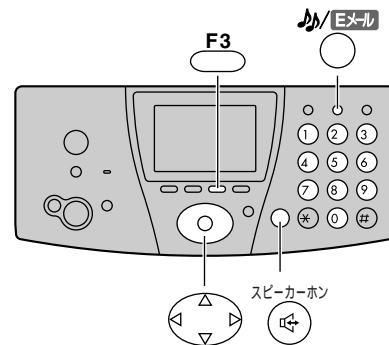

1 Press (E-mail), then press (Set).

2 Press (Search button) repeatedly until the following is displayed.

音声Eメール受信

3 Press (Set).

4 Enter the document number with 4 digits.

- See the example below about document number.

5 Press (Register).

6 Listen to an announcement through the speaker or the handset.

7 Listen to the voice message and operate following voice guidance.

8 Press (Speakerphone) to finish listening, or replace the handset if you are using it.

Note:

- You can hear a voice in WAV format only.
- Voice data will be saved for 1 week in the server after the e-mail has been received.

Example of received e-mail document.

受信日時：2002/02/01 15:55 合計1ページ

タイトル：鳥の声

送信日時：2002/02/01 15:52:04

差出人：taro@pana.co.jp

宛先：p1234 @fem.dion.ne.jp

文書番号：0002 ← Document number

Individual e-mail services

Sending a text e-mail from the main unit

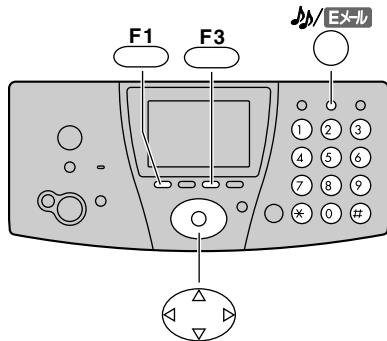

- 1 Press (E-mail), then press (Set).
- 2 Press (Search button) repeatedly until the following is displayed.

文字 E-mail 送信
- 3 Press (Set).
- 4 Enter the desired e-mail address (see the table on page 10 for instructions), then press (Register).
 - You can select the desired address using the search button.
 1. Press (Phonebook), then press (Search button) repeatedly until the desired e-mail address is displayed.
 2. Press (Set), then press (Register).
 To store an address, see page 31.
- 5 Press (Register).
 - The display will show the last title you entered. To delete this title, press (Clear) for 2 or more seconds.
- 6 Enter the title of your e-mail, up to 32 characters (see the table on page 10 for instructions).
- 7 Press (Register).
 - The display will show the last message you entered. To delete this message, press (Clear) for 2 or more seconds.
- 8 Enter your e-mail message, up to 200 characters (see the table on page 10 for instructions).
- 9 Press (Register).

Sending a fax e-mail

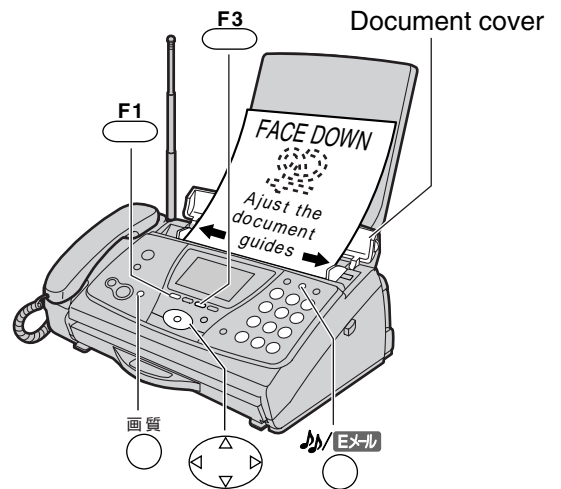

- 1 Open the document cover, and adjust the width of the document guides to the size of the document.
- 2 Insert the document (up to 5 pages) FACE DOWN until a single beep is heard.
- 3 If necessary, press (Resolution) repeatedly to select the desired setting (see page 16).
- 4 Press (E-mail), then press (Set).
- 5 Enter the desired e-mail address (see the table on page 10 for instructions) and press (Register).
 - You can select the desired address using the search button.
 1. Press (Phonebook), then press (Search button) repeatedly until the desired e-mail address is displayed.
 2. Press (Set), then press (Register).
 To store an address, see page 31.
- 6 Press (Register).
 - The display will show the last title you entered. To delete this title, press (Clear) for 2 or more seconds.
- 7 Enter the title of your fax e-mail, up to 32 characters (see the table on page 10 for instructions).
- 8 Press (Register).

Individual e-mail services

Sending a voice e-mail

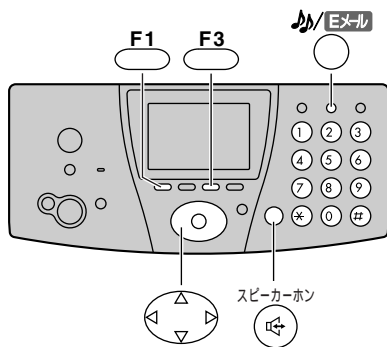

- 1 Press (E-mail), then press (Set).
- 2 Press (Search button) repeatedly until the following is displayed.

音声 Eメール送信
- 3 Press (Set).
- 4 Enter the desired e-mail address (see the table on page 10 for instructions) and press (Register).
 - You can select the desired address using the search button.
 1. Press (Phonebook), then press (Search button) repeatedly until the desired e-mail address is displayed.
 2. Press (Set), then press (Register).
To store an address, see page 31.
- 5 Press (Register).
 - The display will show the last title you entered.
To delete this title, press (Clear) for 2 or more seconds.
- 6 Enter the title of your e-mail, up to 32 characters (see the table on page 10 for instructions).
- 7 Press (Register).
 - An announcement about how to record will be heard.
- 8 Record your voice message up to 60 seconds, following voice guidance, using the microphone or the handset.
- 9 Press (Speakerphone) to finish recording, or replace the handset if you are using it.

Individual e-mail services

Storing another party's e-mail address in the search button

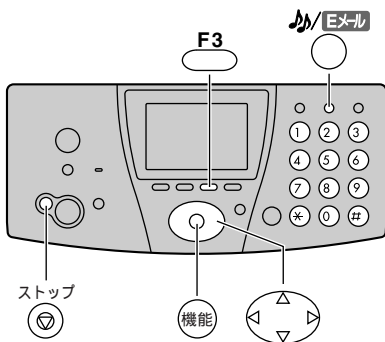

1 Press **機能** (Function), then press **Eメール** (E-mail).

2 Press **◀▶** (Search button) repeatedly until the following is displayed.

アトレス帳

3 Press **決定 F3** (Set).

4 Press **登録 F3** (Register).

- "XX" shows the remaining station numbers you can store.

アトレス帳 空き xx件



名前?
█
>_

5 Enter the name, up to 12 characters (see the table on page 10 for instructions).

6 Press **登録 F3** (Register) twice.

7 Enter the e-mail address, up to 60 characters (see the table on page 10 for instructions).

8 Press **登録 F3** (Register).

- To program other items, repeat steps 5 to 8.
- You can store up to 30 stations.

9 Press **ストップ** (Stop) to exit the program.

Editing a stored e-mail address

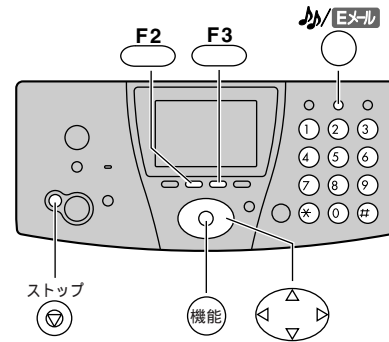

1 Press **機能** (Function), then press **Eメール** (E-mail).

2 Press **◀▶** (Search button) repeatedly until the following is displayed.

アトレス帳

3 Press **決定 F3** (Set).

4 Press **◀▶** (Search button) repeatedly until the desired name is displayed.

5 Press **修正 F2** (Edit).

6 Edit the name (see the table on page 10 for instructions), then press **登録 F3** (Register).

- If you do not need to edit the name, press **登録 F3** (Register) and skip to step 7.

7 Edit the kana (see the table on page 10 for instructions), then press **登録 F3** (Register).

- If you do not need to edit the kana, press **登録 F3** (Register) and skip to step 8.

8 Edit the e-mail address (see the table on page 10 for instructions).

- If you do not need to edit the e-mail address, skip to step 9.

9 Press **登録 F3** (Register).

- To edit other items, repeat steps 4 to 9.

10 Press **ストップ** (Stop) to exit the editing.

Specifications

KX-PW101CL/ PW102CW	Main unit	Portable handset	Battery charger	Hand scanner
Power supply	AC 100 V (50 Hz/60 Hz)	Ni-Cd battery (Part no. KX-FAN37) DC 2.4 V, 600 mAh	AC adaptor (Part no. PFAP1009) AC 100 V (50 Hz/60 Hz) DC 7.5 V, 100 mA	Ni-Cd battery (Part no. KX-FAN38) DC 3.6 V, 600 mAh
Power consumption	Transmission: Approx. 16W Reception: Approx. 20W Copy: Approx. 20W Stand by: Approx. 1.3W Maximum(*1): Approx. 125W		• Charging: Approx. 1.1W • Stand by: Approx. 0.4W	
Dimensions (H x W x D)	Approx. 139 X 344 X 262 mm (without projections) Approx. 378 X 344 X 310 mm (recording paper tray installed, without projections)	Approx. 181X44X40 mm (without projections) Approx. 190X44X40 mm (included call/charge indicator)	Approx. 72X72X90 mm	Approx. 35X274X81 mm (without projections)
Mass (Weight)	Approx. 3.9 kg (10 m ink film installed)	Approx. 170 g (battery installed)	Approx. 77g	Approx. 340 g (battery installed)
Operating environment	5 °C – 35 °C, 45 % – 85 % RH (Relative Humidity)			

KX-PW101CL/ PW102CW	Main unit	Hand scanner
Applicable line	Public Switch Telephone Network (Tone/Pulse), F-Net, NCC Lines	
DC resistance	320 Ω (*2)	
Compatibility	G3 compatible	
Document size	B4-A5(Max.257 mm in width, Max. 800 mm in length)	
Effective scanning size	252 mm (B4) 208 mm (A4)	Max. 252 mm (B4)
Effective printing size	202 mm (A4 size plain paper)	
Transmission time	Approx. 15 s/page (Original mode) (*3)	
Modem speed	9,600 / 7,200 / 4,800 / 2,400 bps; Automatic fallback	
Halftone level	64-level	
Scanning density	Horizontal: 8 pels/mm Vertical: 7.7 lines/mm (Fine/Photo), 3.85 lines/mm (Standard)	Horizontal:8 pels/mm Vertical: 7.7 lines/mm
Scanner type	CCD image sensor	CCD image sensor
Printer type	Thermal transfer printing on plain paper	
Data compression system	Modified Huffman (MH), Original mode	
Recording paper size	A4: 210 mm x 297 mm (Plain paper)	
Answering device	Greeting message: Digital recording system (up to 16 sec) Pre-recording greeting message ICM Recording: Digital recording system (Approx. 18 min. in total) (*4)	
Memory capacity	Max. Approx. 46 pages (Only receiving fax etc.) (*5) Max. Approx. 18 min. (Only Recording message) (*4)	20 pages Text (Standard) (*5) 10 pages Text (Fine) (*5) Approx. A4 1 page (Photo)
Talk time during power failure	After the hand scanner battery has been charged for about 10 hours: • Successive talk time :Approx. 90 min. • Standby time :Approx. 10 hours	

*1 When copying a 100% black document.

*2 If you cannot make a call due to DC resistance, consult your dealer.

*3 Transmission speed is based on an A4-size document of 700 characters sent in standard resolution at 9,600 bps. The actual transmission speed depends upon the contents of the page, resolution, telephone line conditions and capability of the other party's machine.

*4 If there is a silent pause, the total recording time will be longer.

*5 The memory capacity is based on an A4-size document of 700 characters.

Free Manuals Download Website

<http://myh66.com>

<http://usermanuals.us>

<http://www.somanuals.com>

<http://www.4manuals.cc>

<http://www.manual-lib.com>

<http://www.404manual.com>

<http://www.luxmanual.com>

<http://aubethermostatmanual.com>

Golf course search by state

<http://golfingnear.com>

Email search by domain

<http://emailbydomain.com>

Auto manuals search

<http://auto.somanuals.com>

TV manuals search

<http://tv.somanuals.com>