

Facsimile

Quick Reference Guide

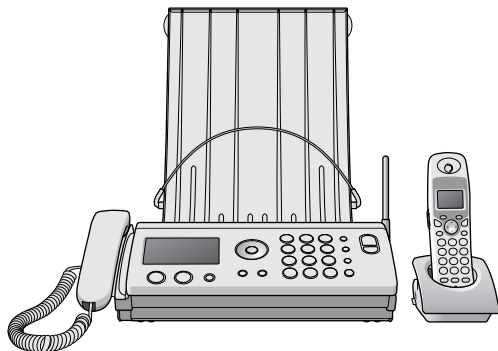

KX-PW505DL

Model No. **KX-PW505DL**
KX-PW505DW

Main unit: KX-PW505
 Portable handset: KX-FKN521

Thank you for purchasing a Panasonic facsimile.

Table of Contents

Finding the controls	2
Installations and connections	4
Setting the date and time.....	7
Setting your facsimile telephone number	7
Setting your logo	8
Character input and command key table	9
Voice guide.....	10
Automatic dialing on the main unit	11
Automatic dialing on the portable handset (KX-FKN521)	12
Intercom	13
Sending faxes	14
Receiving faxes	15
Operating the built-in answering device	16
Night mode.....	19
Call block	19
Specifications	Back cover

- This guide explains some basic features and operations, but not all of them. For further details, see the Japanese operating instructions.
- This product is designed for use in Japan.
Panasonic cannot provide service for this product if used outside Japan.
- Any details given in this guide are subject to change without notice.

This unit is equipped with the voice guide features. (Japanese only)
For details about voice guide, please see page 10.

Finding the controls

Main unit

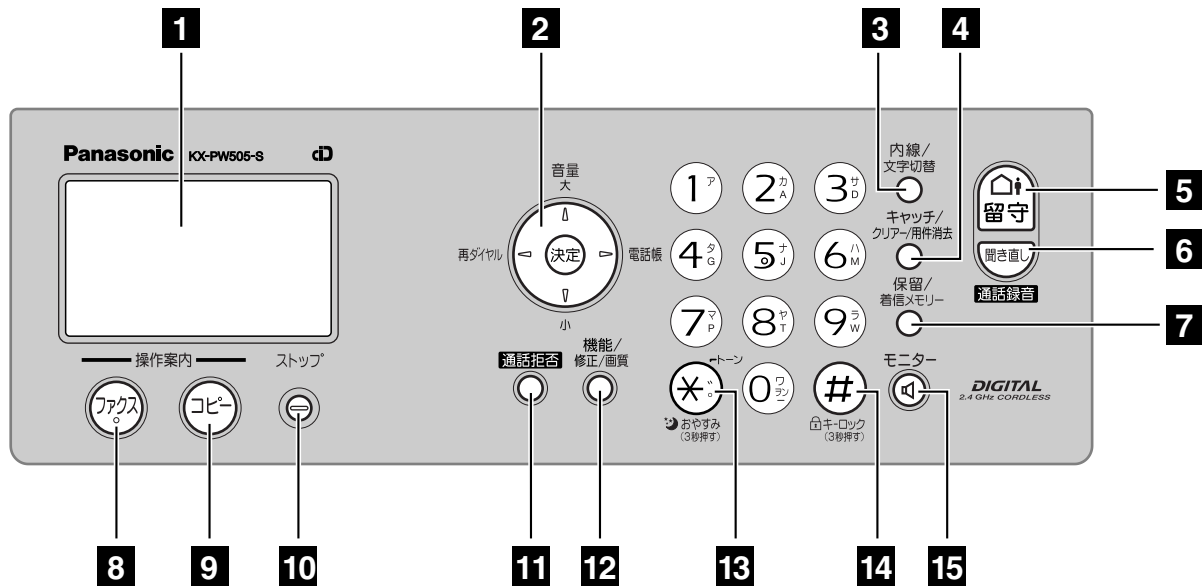

1 Liquid crystal display

2 Volume/Redial/Phonebook/Set key



To adjust the volume.



To redial the phone numbers in the redial list. The last 10 phone numbers dialed are stored in memory.



To use the phonebook.



To store a parameter.

3 Intercom button

Character Input Mode button

4 Flash button

(For call waiting service users.)

Clear/Erase button

5 Auto Answer button & indicator

—light on: answering device activated.

—light off: used as a regular telephone.

6 Replay button plays back recorded messages.

Record button records a telephone conversation. You can also record a telephone conversation while the portable handset is on a call.

7 Hold button

Call Memory button starts a search in the Number Display (Caller ID) log. (For Number Display service users.)

8 Fax button starts faxing.

9 Copy button starts copying.

10 Stop button

11 Block button for the undesired call

12 Function button initiates programming.

Edit button

Resolution button selects the resolution when faxing or copying.

13 Tone button switches to tone dialing.

Night mode button

14 Sharp button

Key lock button can lock the main unit so that no calls or settings can be made. To turn key lock on, press this button for about 3 seconds until a single beep is heard.

- “**キロック**” is displayed

- To turn key lock off, press this button for about 3 seconds.

15 Monitor button

Finding the controls

Portable handset (KX-FKN521)

How to use key

- To use the phonebook.
- To redial the phone numbers in the redial list. The last 10 phone numbers dialed are stored in memory.
- To adjust the volume.

How to use key

- To change the tone heard from the earpiece.

How to use key

- To make/answer calls.
- To end a call.
- To end or exit from editing or other operations.

How to use and keys

- To page the main unit and/or portable handset(s).
- To change the character input mode.

How to use key

- To put a call on hold.
- To start a search in the Number Display log. (For Number Display service users.)

How to use buttons

F1 and **F2** buttons refer to the function displayed on the bottom of the display. They function differently depending on the mode.

Dial buttons

- Tone button
 - To switch to tone dialing.
- Sharp button

Liquid crystal display

① Portable handset number (and name)
 ② No link to the main unit
 ③ Function menu that is controlled by **F1** or **F2**
 ④ Battery strength

Microphone
 (Do not cover the microphone while talking.)

クリアー ● For call waiting service users.
 ● To clear letters/numbers.

ボイスチェンジ ● To change your voice.
 ● To mute your voice to the other party by pressing this button for about 2 seconds. (To release the mute, press this button again.)

スピーカーホン ● To use the speakerphone.

Installations and connections

Installing the ink film

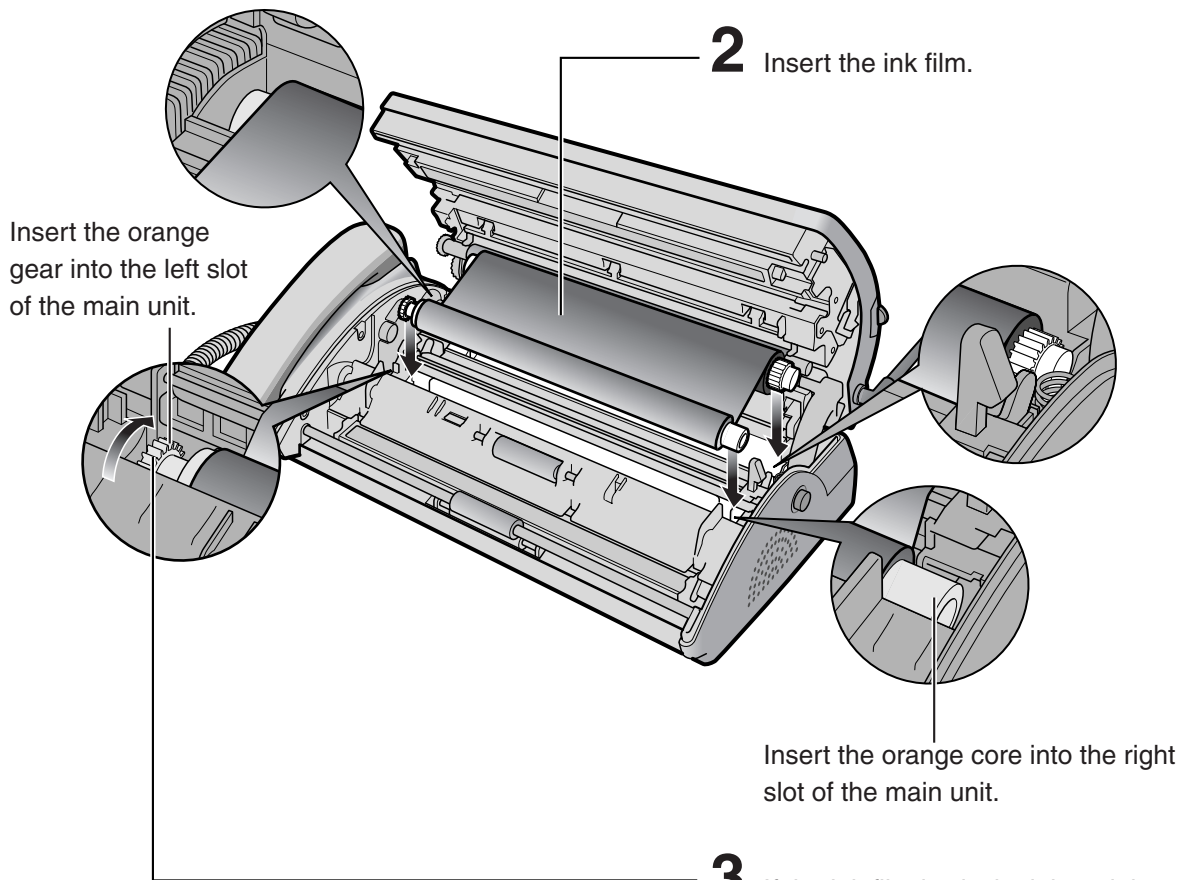
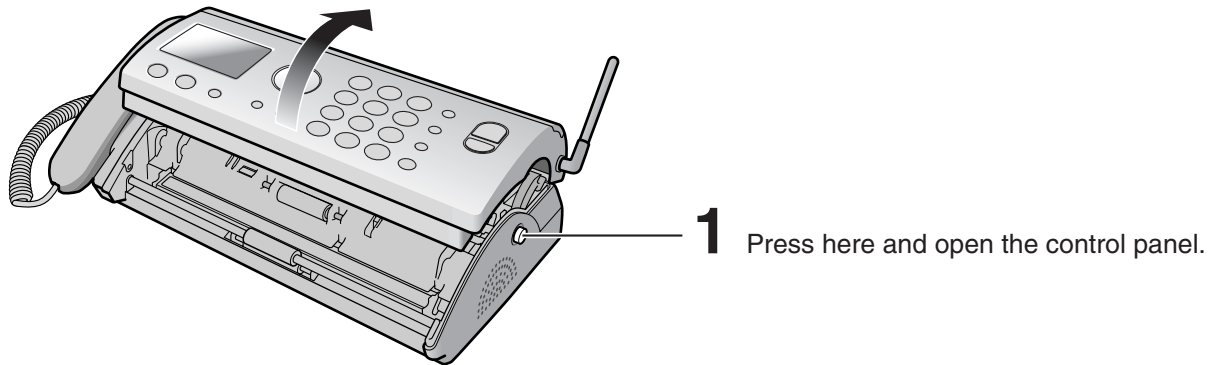

4 Close the control panel until it locks.

- When the unit runs out of ink film, the following message will be displayed.

フィルムが ナクナリマシタ
コウカンシテクタ サイ U23 ↔ フィルムが ナクナリマシタ
ヒンバノン : KX-FAN200

Install a new ink film.

Replacement ink film:
KX-FAN200 (30 m) ¥1,208

· As of September 2005. · Tax included.

Installations and connections

Installing recording paper (A4 size)

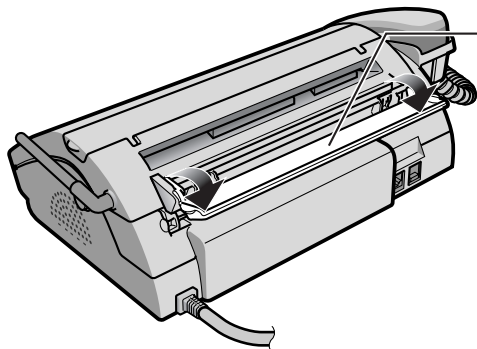

- 1** Open the recording paper insertion cover.

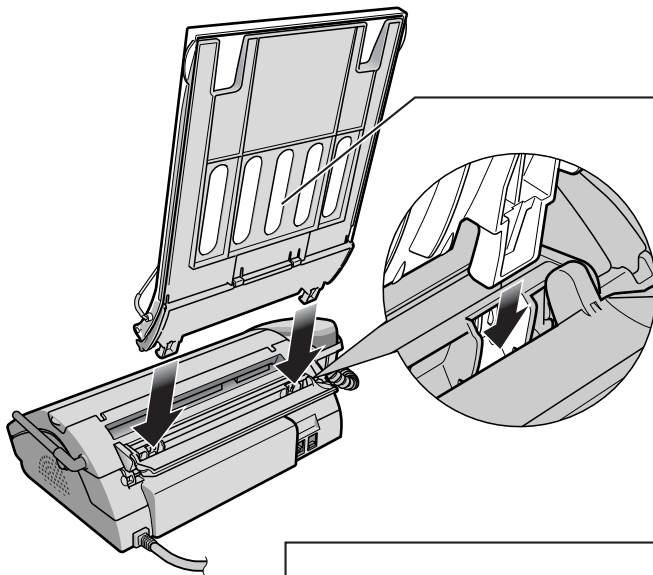

- 2** Install the recording paper cover/tray.

- 3** Open the recording paper cover.

- 4** Insert the recording paper into the recording paper tray. (Up to 20 sheets)

- Fan the stack of recording paper.

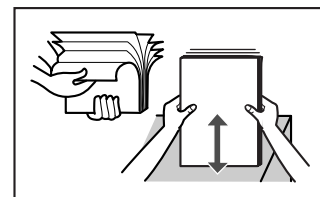

Recording paper

- Printing side is on the back.

- 5** Close the recording paper cover.

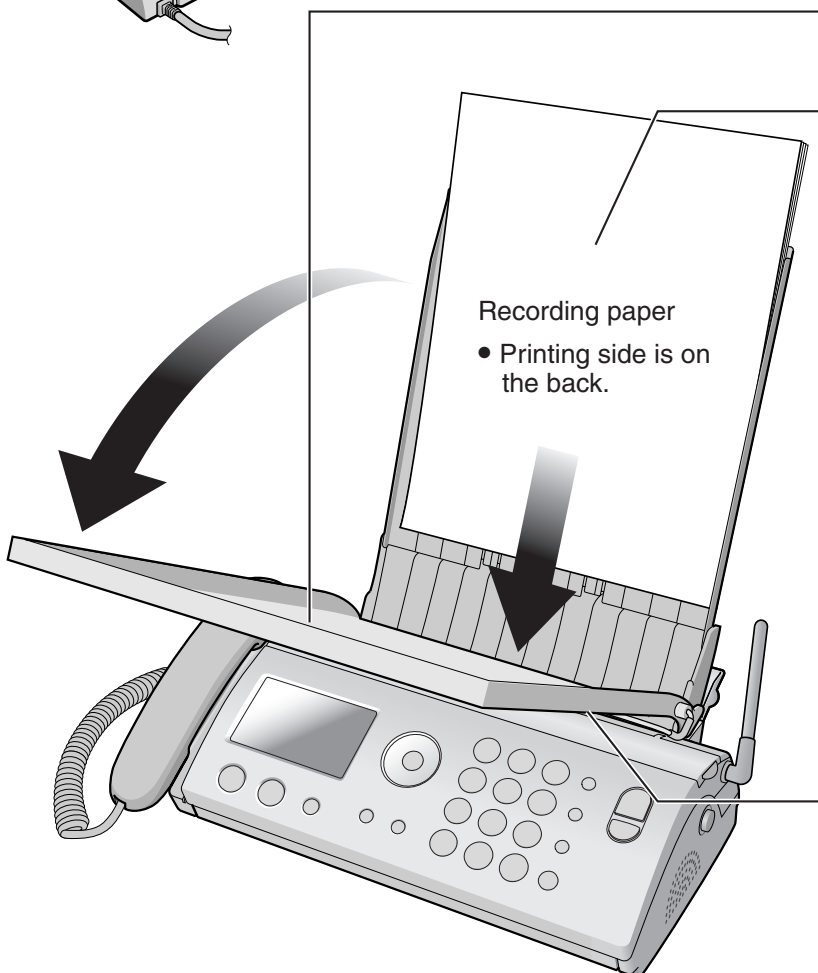

Installations and connections

Connecting the main unit

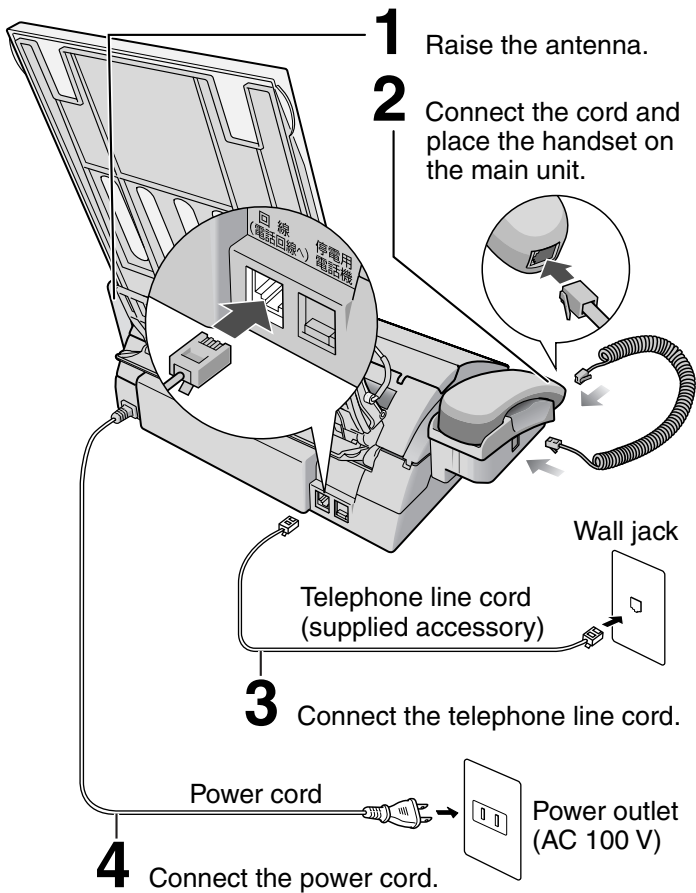

After the Power On...

This unit will automatically select the dialing mode (Tone/Pulse).



If you can not make a call...

Set the dialing mode with the main unit.

1. Press (Function/Edit/Resolution).
2. Press .
3. Press (Search button) repeatedly until the desired setting is displayed.

Example :

カイセンシユハツ=20
[◀▶.ケツテイ] 扱

- フツシユ : Tone
- 20 : Pulse (20 PPS)
- 10 : Pulse (10 PPS)

4. Press (Set).

5. Press (Stop).

Setting up the portable handset (KX-FKN521)

1

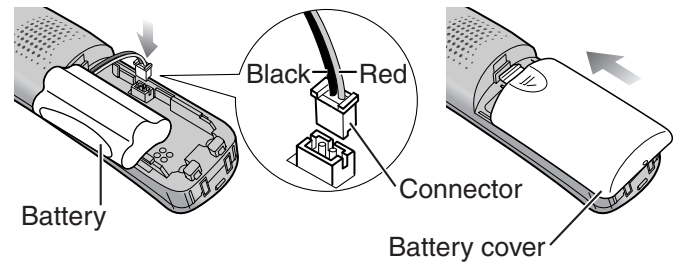

2

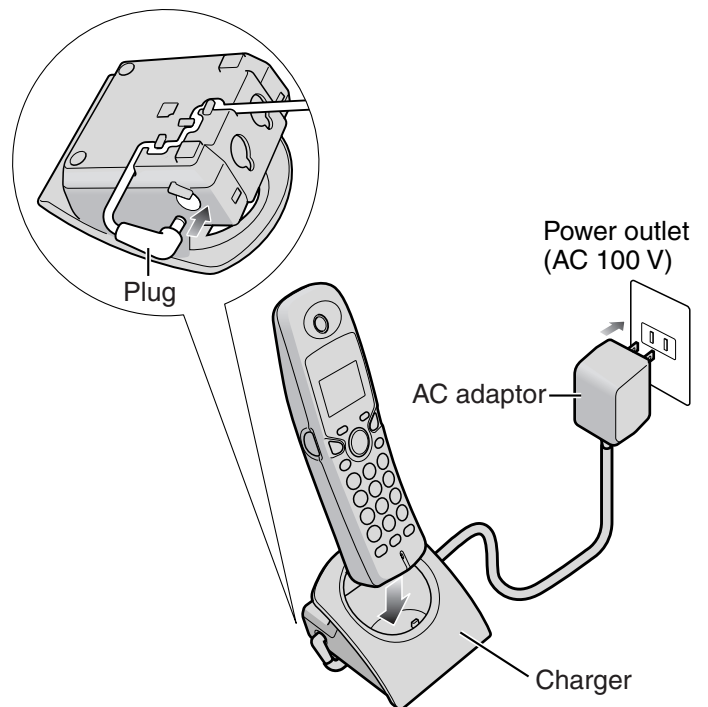

- 3** Charge the battery in the charger **for 10 hours**.

- After your Panasonic battery is fully charged, it will last up to about 7 hours of conversation.

Setting the date and time

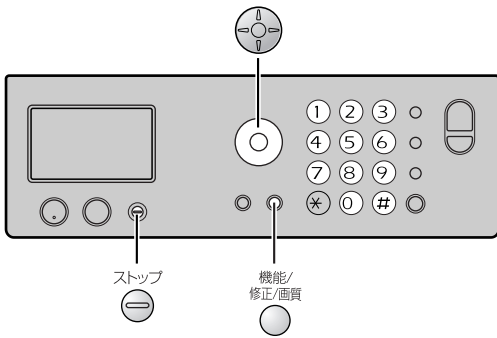

1 Press (Function/Edit/Resolution).

キノウ トウロク モード
[▼▲]オス

2 Press .

Example : 2005年09月30日
15:00
Cursor

3 Enter the correct year/month/day.

Example: **October 1, 2005**

Press .

2005年10月01日
15:00

4 Enter the correct hour/minute in a 24-hour clock entry.

Example: **15:45 (3:45 PM)**

Press .

2005年10月01日
15:45

5 Press (Set).

トウロク シマシタ



2005年10月01日
15:45

6 Press (Stop).

Example : 10月 1日 15:45
ヨウケン ロクオン 00ケン

Setting your facsimile telephone number

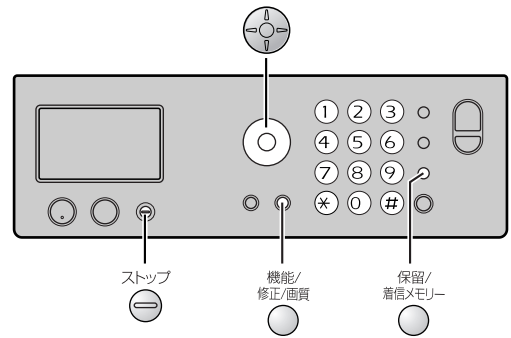

1 Press (Function/Edit/Resolution).

キノウ トウロク モード
[▼▲]オス

2 Press .

アナタノテレホンナンバー?
TEL=#.....
Cursor

3 Enter your facsimile telephone number, up to 20 digits.

Example: **+098 7654..**

アナタノテレホンナンバー?
TEL=#098 7654..

- The (Tone) button replaces the digit with "+".
- The (Hold/Call memory) button replaces the digit with a space.

4 Press (Set).

トウロク シマシタ



アナタノテレホンナンバー?
TEL=#098 7654..

5 Press (Stop).

Example : 10月 1日 15:45
ヨウケン ロクオン 00ケン

Setting your logo

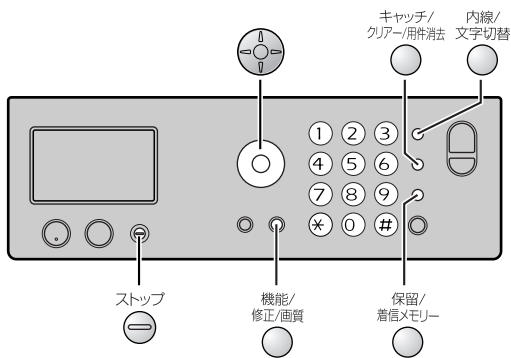

1 Press (Function/Edit/Resolution).

キノ トウロク モード
[▼▲]オス

2 Press .

アナタノナマイ?
Cursor

3 Enter your logo, up to 30 characters, using the dial keypad.

- To enter English characters easily, press (Intercom/Character input mode) repeatedly and select “英” (English and sign input mode).
- For details, see the table on page 9 for instructions.

Example: Micah

1. Press once.

アナタノナマイ?
M
Cursor

2. Press six times.

アナタノナマイ?
Mi

3. Press six times.

アナタノナマイ?
Mic

4. Press to move the cursor to the next space and press four times.

アナタノナマイ?
Mica

5. Press five times.

アナタノナマイ?
Micah

4 Press 決定 (Set).









トウロク シマシタ
↓
アナタノナマイ?
Micah

5 Press (Stop).

Example : 10月 1日 15:45
ヨウケン ロクオン 00ケン

Character input and command key table

Pressing the dial keys will select a character as shown below.

Character		Katakana	English	Numbers
Display of the main unit		カナ	英	数
Display of the portable handset		[カナ]	[AB]	[12]
Dial key				
(Main unit)	(Portable handset KX-FKN521)			
①	①	アイウエオアイウエオ	@ . _ - & \$ ¥ % + = ~ ^	1
②	②	カキクケコ	A B C a b c	2
③	③	サシスセソ	D E F d e f	3
④	④	タチツテトツ	G H I g h i	4
⑤	⑤	ナニヌネノ	J K L j k l	5
⑥	⑥	ハヒフヘホ	M N O m n o	6
⑦	⑦	マミムメモ	P Q R S p q r s	7
⑧	⑧	ヤユヨヤユヨ	T U V t u v	8
⑨	⑨	ラリルレロ	W X Y Z w x y z	9
⑩	⑩	ワヲンー!?()	! ? / - * # , ; : · ' " () [] { } < > 「 」	0
✳	✳	” ° 、 。	、 。	
Command keys		<small>内線/文字切替</small>  (Main unit), <small>内線文字切替</small>  (Portable handset)	Used to change the character input mode.	
		 (Main unit),  (Portable handset)	Used to move the cursor to the left and right.	
		<small>キャッチ/クリアー/用件消去</small>  (Main unit), <small>クリアーキャッチ</small>  (Portable handset)	Used to delete a character.	
		<small>保留/着信メモリー</small>  (Main unit), <small>保留</small>  (Portable handset)	Used to insert a space.	

- The characters on the display are somewhat different from those shown in the character input and command key table.

Operation guide

The unit starts the following voice guidance in Japanese:

Operations	To cancel the operation guide
Send a fax	機能/修正/画質 → # 0 2 1 → (Select [ナシ]) → 決定 → ストップ
Copy	機能/修正/画質 → # 0 2 1 → (Select [ナシ]) → 決定 → ストップ
Add entries to the phonebook	機能/修正/画質 → # 1 6 7 → (Select [ナシ]) → 決定 → ストップ
Make a call using the phonebook/redial/call memory	機能/修正/画質 → # 1 6 7 → (Select [ナシ]) → 決定 → ストップ
Change a ink film	機能/修正/画質 → # 1 7 3 → (Select [ナシ]) → 決定 → ストップ
Print fax documents from the main unit memory	機能/修正/画質 → # 1 7 7 → (Select [ナシ]) → 決定 → ストップ

Error announcements

The unit can make an announcement to alert you when the following errors or trouble occurs:

- The control panel is opened while sending a fax or printing
- The recording paper runs out or jams
- The ink film runs out
- The document paper jams or does not eject properly

• To cancel the error announcements



Reading-out dial

The unit announces the number dialed, when you make a call with the main unit.

• To cancel the reading-out dial



Automatic dialing on the main unit

Storing names and telephone numbers in the phonebook

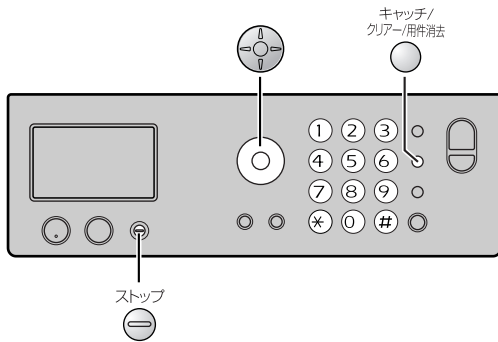

1 Press 電話帳 (Phonebook).

トウロク ハ [ケツテイ]オス
ケンサク ハ [▼▲]オス

2 Press 決定 (Set).

- “XXX” shows the remaining station numbers you can store.
- You can program up to 150 stations, including 4 pre-programmed stations.

テ ソンワチヨウ アキXXXケン

3 Enter the name, up to 12 characters (see the table on page 9 for instructions).

4 Press 決定 (Set).

5 Enter the telephone number, up to 24 digits.

- To correct a mistake, press (Flash/Clear/Erase).

6 Press 決定 (Set).

7 Enter the group number (① to ⑨).

8 Press 決定 (Set).

- To program other items, repeat steps 3 to 8.

9 Press ストップ (Stop) to exit the program.

Making a voice call using the phonebook

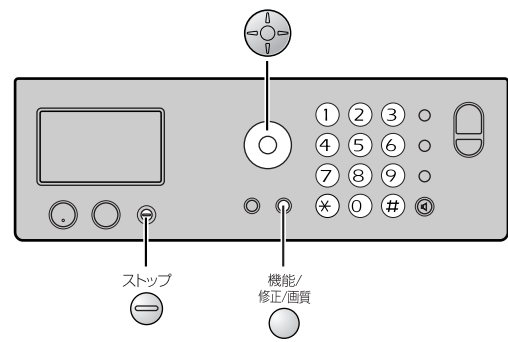

1 Press 電話帳 (Phonebook).

2 Press (Search button) repeatedly until the desired name is displayed.

3 Lift the handset.

Editing a stored name or number in the phonebook

1 Press 電話帳 (Phonebook).

2 Press (Search button) repeatedly until the desired name is displayed.

3 Press 機能/修正/画質 (Function/Edit/Resolution).

4 Edit the name (see the table on page 9 for instructions).

- If you do not need to edit the name, skip to step 5.

5 Press 決定 (Set).

6 Edit the telephone number.

- If you do not need to edit the telephone number, skip to step 7.

7 Press 決定 (Set).

8 Edit the group number.

- If you do not need to edit the group number, skip to step 9.

9 Press 決定 (Set).

10 Press ストップ (Stop).

Automatic dialing on the portable handset (KX-FKN521)

Storing names and telephone numbers in the phonebook

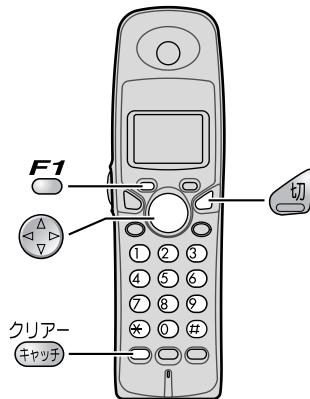

1 Press 電話帳 (Phonebook).

ケンサクハ [▼▲]オス

2 Press .

- “XXX” shows the remaining station numbers you can store.
- You can program up to 150 stations, including 4 pre-programmed stations.

ナマイ? [カナ]
アキ XXXケン

3 Enter the name, up to 12 characters (see the table on page 9 for instructions).

4 Press .

5 Enter the telephone number, up to 24 digits.

- To correct a mistake, press (Clear).

6 Press .

7 Enter the group number (① to ⑨).

8 Press .

- To program other items, repeat steps 3 to 8.

9 Press (Off) to exit the program.

Making a voice call using the phonebook

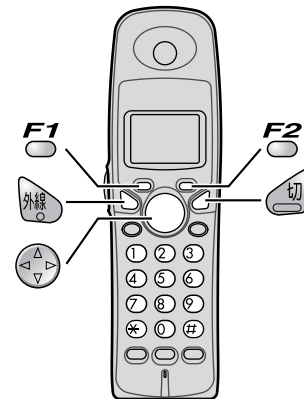

1 Press 電話帳 (Phonebook).

2 Press (Search button) repeatedly until the desired name is displayed.

3 Press (Talk).

Editing a stored name or number in the phonebook

1 Press 電話帳 (Phonebook).

2 Press (Search button) repeatedly until the desired name is displayed.

3 Press .

4 Edit the name (see the table on page 9 for instructions).

- If you do not need to edit the name, skip to step 5.

5 Press .

6 Enter the correct telephone number.

- If you do not need to edit the telephone number, skip to step 7.

7 Press .

8 Edit the group number.

- If you do not need to edit the group number, skip to step 9.

9 Press .

10 Press (Off) to exit the program.

Intercom

An intercom is available between the portable handsets or between the main unit and portable handset(s).

Using the main unit:



1 ■ For single portable handset users

- ① Lift the handset.

デマンボンゴウ?

- ② Press  (Intercom/Character input mode).

コキ1 ヨビダシ チュウ

■ For multiple portable handset users

- ① Lift the handset.

- ② Press  (Intercom/Character input mode).

- ③ Call the portable handset(s) in the following ways:
- To call a specific portable handset, press the portable handset number (① to ⑥) which you want to call.
 - To call all the portable handsets, press .

2 Start talking.

Example : コキ1 ナイセンツウワ チュウ

3 Replace the handset to end the intercom call.

Using the portable handset (KX-FKN521):

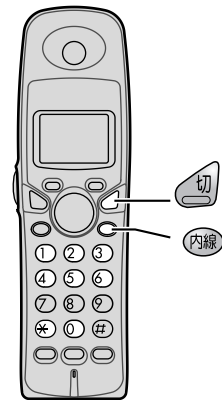



1 ■ For single portable handset users

- Press  (Intercom).

■ For multiple portable handset users

- ① Press  (Intercom).

- ② Call the main unit and/or portable handset(s) in the following ways:
- To call a specific portable handset, press the portable handset number (① to ⑥) which you want to call.
 - To call the main unit, press .
 - To call the main unit and all the portable handsets, press .

2 Start talking.





ナイセンツウワ チュウ

3 Press (Off) to end the intercom call.

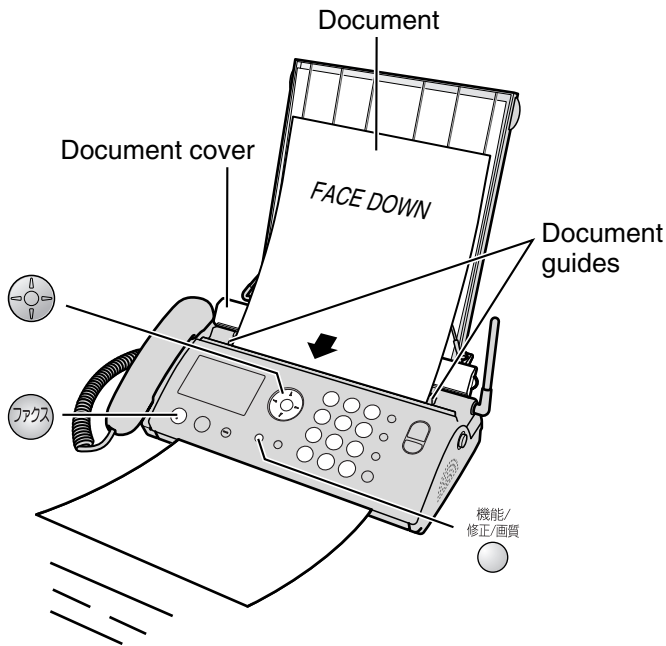
Sending faxes



Sending a fax manually



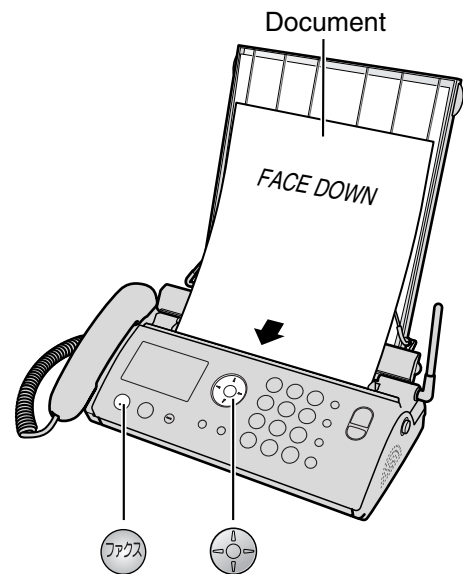

- 1 Open the document cover, and adjust the width of the document guides to the size of the document.
- 2 If necessary, press  (Function/Edit/Resolution) 2 times, press  repeatedly to select the desired setting, then press  (Set) (see below).
- 3 Insert the document (up to 5 pages) FACE DOWN until a single beep is heard.
- 4 Press  (Fax).
- 5 Dial the fax number.
- 6 Press  (Fax).
 - The unit will start fax transmission.

Sending a fax using the phonebook



- 1 Insert the document (up to 5 pages) FACE DOWN until a single beep is heard.
- 2 Press  (Phonebook).
- 3 Press  (Search button) repeatedly until the desired name is displayed.
- 4 Press  (Fax).
 - The unit will start fax transmission.

To select the resolution

Select the desired resolution according to the type of document, by pressing  (Function/Edit/Resolution) 2 times, then press  repeatedly. Press  (Set) to decide the resolution.

カ シツ=フツウ
[◀▶, ケツテイ] オス

(Standard) for printed or typewritten originals with normal-sized characters.

カ シツ=チイサイ
[◀▶, ケツテイ] オス

(Fine) for originals with minute printing.

カ シツ=シャシン
[◀▶, ケツテイ] オス

(Photo) for originals containing photographs.

Receiving faxes

Receiving a fax manually (AUTO ANSWER off)

Using the main unit:

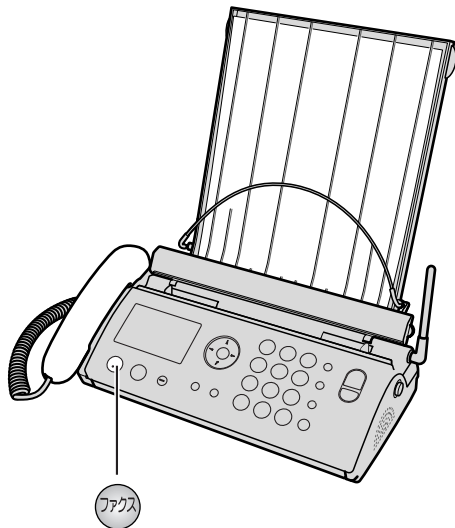

1 When you hear a ring, lift the handset to answer the call.

2 When:
– document reception is required,
– a fax calling tone (slow beep) is heard, or
– no sound is heard,
press **ファクス** (Fax), then replace the handset.

- The unit will start fax reception.

Using the portable handset (KX-FKN521):

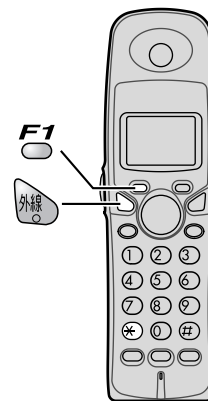

1 When you hear a ring, lift the portable handset from the charger to answer the call.
• If the portable handset is not set on the charger, press **外線** (Talk).

2 When:
– document reception is required,
– a fax calling tone (slow beep) is heard, or
– no sound is heard,
press **F1**, then press *****.
• The main unit will start fax reception.

Receiving faxes

Receiving a fax automatically (AUTO ANSWER on)

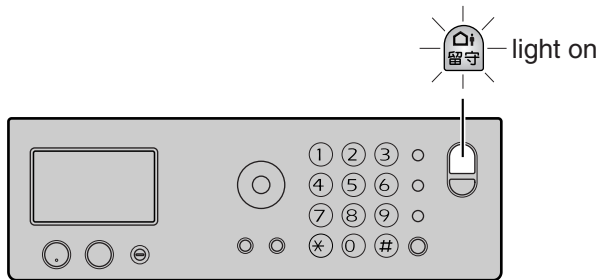

- 1 If the (Auto answer) light is off, turn it on by pressing .
- 2 When receiving a call, the unit will receive a fax document or record a voice message automatically depending on the caller's request.

Operating the built-in answering device

Recording your own greeting message

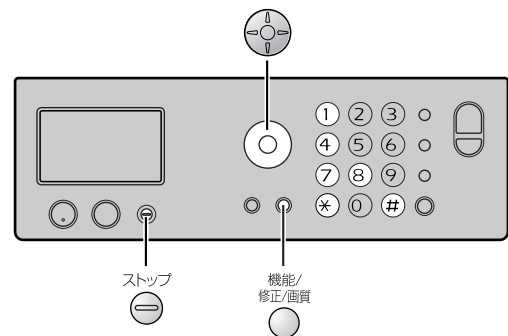

You can record your own greeting message. When receiving a call, it will be played to callers instead of the pre-recorded Japanese greeting message.

- 1 Press (Function/Edit/Resolution).
- 2 Press .

ジ サク オウトウ ロクオン
[ケッテイ]オス
- 3 Press (Set).
- 4 Lift the handset.
- 5 Press (Set) and speak your greeting message after a beep, up to 16 seconds, to the handset.
- 6 Press (Stop) and replace the handset.
 - Your greeting message will be played back automatically.

Erasing your own greeting message

- 1 Press (Function/Edit/Resolution).
- 2 Press .

ジ サク オウトウ ショウキョ
[ケッテイ]オス
- 3 Press (Set).
- 4 Press .
- The pre-recorded Japanese greeting message will be played when you receive a call.

Operating the built-in answering device

Activating the answering device

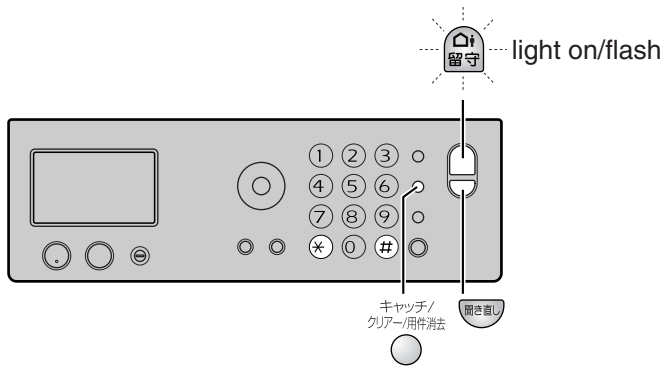

- 1 Turn the **留守** (Auto answer) light on by pressing **留守**.
- 2 When receiving a call, a greeting message will be played and the unit will record a voice message.
 - To record your own greeting message, see page 16.

Listening to recorded messages

When new messages are recorded, the **留守** (Auto answer) light will flash.

Press **留守** to listen to recorded messages.

After the messages are played back, the following will be displayed.

- To erase the messages, press *****.

サイセイシタヨウケンシヨウキヨ スル=* シナイ=#

- To save the messages, press **#**.

Listening to all of the recorded messages

Press **聞き直し** (Replay).

After the messages are played back, the following will be displayed.

- To erase the messages, press *****.

サイセイシタヨウケンシヨウキヨ スル=* シナイ=#

- To save the messages, press **#**.

Erasing a specific message

Press **キャッチ/クリアー/用件消去** (Flash/Clear/Eraser) while listening to the message you want to erase, then press *****.

Erasing all of the recorded messages

1 Press **キャッチ/クリアー/用件消去** (Flash/Clear/Eraser).

スハ`テ ショウキヨシマスカ? ハイ=* イイエ=#



2 Press *****.

Operating the built-in answering device

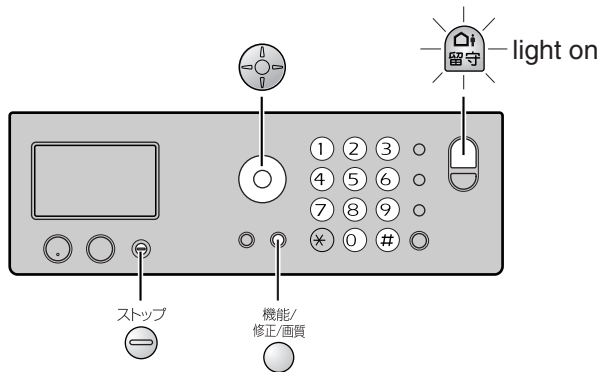
Operating the answering device from a remote location



Preparation: Programming the remote operation ID

1. Press  (Function/Edit/Resolution).
2. Press .
3. Enter any 4-digit number (remote operation ID) except * or #.

Example :

アソシヨウ No.=1234
[4ケタ,ケツタイ]オス



4. Press  (Set).

5. Press  (Stop).

Operation: Listening to a recorded message from a remote location

Turn the  (Auto answer) light on before you go out.

Remote operations are available only from a touch tone telephone.



1. Call your unit.
2. Enter the remote operation ID during the greeting message.
3. Press  or wait 4 seconds.
 - Only the new recorded messages will be played back.
 - To listen to all the recorded messages, press  after the new messages have been played back.

Night mode

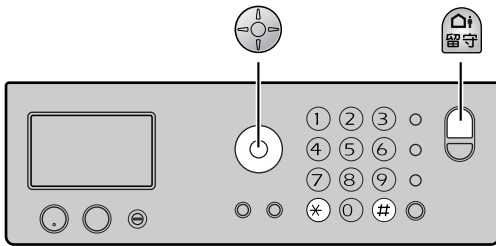
Turn on the night mode



Press  (Night mode) for about 3 seconds.

- “” is displayed and  lights on.
- When a call is received during night mode, the unit will handle the call silently, either by storing the received fax into memory or by recording the caller's message.
- Night mode allows you to select a block of time during which the unit will not ring for outside calls or make sounds when you change the settings. This feature is useful when you do not want to be disturbed, for example, while sleeping.

Listening to recorded messages

When new messages are recorded, the  (Auto answer) light will flash.

Press  to listen to recorded messages.

After the messages are played back, the following will be displayed.

- To erase the messages, press .

サイセイシタヨウケンジョウキョ スル=＊ シナイ=#

- To save the messages, press .

Printing received fax documents

When new faxes are received, the following will be displayed.

ファクスガ トトイテイマス インサツハ [ケツテイ]オス

Press  **決定** (Set) 2 times to print fax documents.

Turn off the night mode

Press  (Night mode) for about 3 seconds.

Call block

Blocking the incoming calls

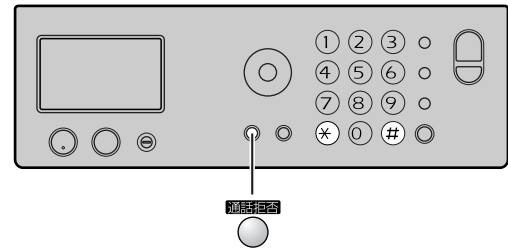

Press  (Block) while the unit is ringing or while you are on an incoming call.

- The unit announces a message to the caller 2 times, then hangs up automatically. The message is announced in Japanese and means “We're sorry, but your call cannot be connected.”.

For Number Display service subscribers



If you subscribe to Number Display service, the message heard by the caller will change according to the caller's situation.

Example :

If the caller requested not to send caller's information, the message heard by the caller will change to mean “Your phone number is blocked by service provider. Please call again with adding ‘186’ to the beginning of the phone number.”.

When the following is displayed after pressing

 (Block), you can set the unit to block the call from the same telephone number.

- To block the call, press .
- To cancel blocking, press .

メイワク セツテイ シマスカ? ハイ=＊ イイエ=#

- When the following is displayed, press  to cancel.

キョヒ セツテイ シマスカ? ハイ=＊ イイエ=#

Specifications

KX-PW505DL KX-PW505DW	Main unit	Portable handset (KX-FKN521)	Battery charger
Power supply	AC 100 V (50 Hz/60 Hz)	Ni-MH battery (Part no. KX-FAN50) DC 3.6 V, 600 mAh	AC adaptor (Part no. PFAP1009) AC 100 V (50 Hz/60 Hz) DC 7.5 V, 100 mA
Power consumption	Transmission: Approx. 10 W Reception: Approx. 15 W Copy: Approx. 20 W Stand by: Approx. 0.9 W (When the F-net service is not in use.) Maximum(*1): Approx. 130 W	/	<ul style="list-style-type: none"> • Charging: Approx. 1.5 W • Stand by: Approx. 0.6 W
Dimensions (H x W x D)	Approx. 100.5 X 332.5 X 193 mm (without handset, projections) Approx. 355.5 X 332.5 X 231 mm (recording paper cover/tray installed, without handset, projections)	Approx. 161 X 47 X 39 mm	Approx. 64 X 80 X 90 mm
Mass (Weight)	Approx. 2.9 kg (10 m ink film installed)	Approx. 140 g (battery installed)	Approx. 80 g
Operating environment	5 °C – 35 °C, 45 % – 85 % RH (Relative Humidity)		

KX-PW505DL KX-PW505DW	Main unit
Applicable line	Public Switch Telephone Network (Tone/Pulse), F-Net, NCC Lines
DC resistance	320 Ω (*2)
Compatibility	G3 compatible
Document size	A4–A5 (Max. 216 mm in width, Max. 600 mm in length)
Effective scanning size	208 mm (A4)
Effective printing size	202 mm (A4 size plain paper)
Transmission time	Approx. 15 s/page (Original mode) (*3)
Modem speed	9,600 / 7,200 / 4,800 / 2,400 bps; Automatic fallback
Halftone level	64-level
Scanning density	Horizontal: 8 pels/mm Vertical : 7.7 lines/mm (Fine/Photo), 3.85 lines/mm (Standard)
Scanner type	Contact image sensor
Printer type	Thermal transfer printing on plain paper
Data compression system	Modified Huffman (MH), Original mode
Recording paper size	A4: 210 mm x 297 mm (Plain paper)
Answering device	Greeting message: Digital recording system (up to 16 sec) Pre-recording greeting message ICM Recording: Digital recording system (Approx. 18 min. in total) (*4)
Memory capacity	Max. Approx. 46 pages (Only receiving fax etc.) (*5) Max. Approx. 18 min. (Only recording message) (*4)

*1 When copying a 100% black document.

*2 If you cannot make a call due to DC resistance, consult your dealer.

*3 Transmission speed is based on an A4-size document of 700 characters sent in standard resolution at 9,600 bps. The actual transmission speed depends upon the contents of the page, resolution, telephone line conditions and capability of the other party's machine.

*4 If there is a silent pause, the total recording time will be longer.

*5 The memory capacity is based on an A4-size document of 700 characters.

© 2005 Panasonic Communications Co., Ltd. All Rights Reserved.

PFQX2323ZA FK0905MH0

Free Manuals Download Website

<http://myh66.com>

<http://usermanuals.us>

<http://www.somanuals.com>

<http://www.4manuals.cc>

<http://www.manual-lib.com>

<http://www.404manual.com>

<http://www.luxmanual.com>

<http://aubethermostatmanual.com>

Golf course search by state

<http://golfingnear.com>

Email search by domain

<http://emailbydomain.com>

Auto manuals search

<http://auto.somanuals.com>

TV manuals search

<http://tv.somanuals.com>