

Facsimile

Quick Reference Guide

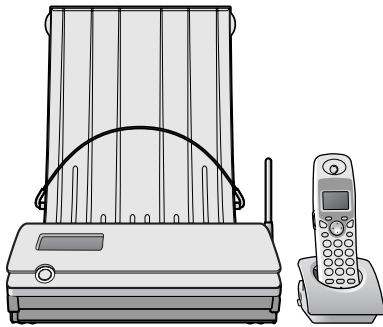

KX-PW513DL

Model No. **KX-PW513DL**
KX-PW513DW

Main unit: KX-PW513
 Portable handset: KX-FKN521

Thank you for purchasing a Panasonic facsimile.

Table of Contents

Finding the controls	2
Installations and connections	4
Setting the date and time.....	7
Setting your facsimile telephone number	7
Setting your logo	8
Character input and command key table	9
Automatic dialing on the main unit	10
Automatic dialing on the portable handset (KX-FKN521)	11
Intercom	12
Sending faxes	13
Receiving faxes	14
Operating the built-in answering device	15
Specifications	18

- This guide explains some basic features and operations, but not all of them. For further details, see the Japanese operating instructions.
- This product is designed for use in Japan. Panasonic cannot provide service for this product if used outside Japan.
- Any details given in this guide are subject to change without notice.

Finding the controls

Main unit

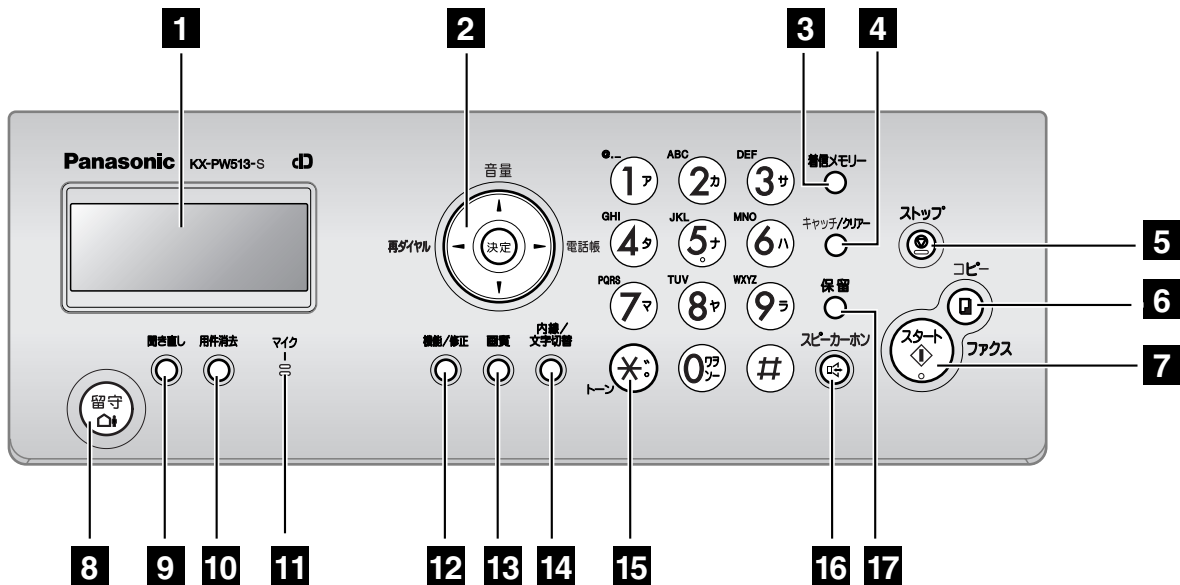

1 Liquid crystal display

2 Volume/Redial/Phonebook/Set key



To adjust the volume.



To redial the phone numbers in the redial list. The last 10 phone numbers dialed are stored in memory.



To use the phonebook.



To store a parameter.

3 Call Memory button starts a search in the Number Display log.

(For caller ID display service users.)

4 Flash button

(For call waiting service users.)

Clear button

5 Stop button

6 Copy button starts copying.

7 Start/Fax button starts faxing.

8 Auto Answer button & indicator

—light on: answering device activated.
—light off: used as a regular telephone.

9 Replay button plays back recorded messages.

10 Erase button

11 Microphone

12 Function button initiates programming. Edit button

13 Resolution button selects the resolution when faxing or copying.

14 Intercom button

Character Input Mode button

15 Tone button switches to tone dialing.

16 Speakerphone button

17 Hold button

Finding the controls

Portable handset (KX-FKN521)

How to use key

- To use the phonebook.
- To redial the phone numbers in the redial list. The last 10 phone numbers dialed are stored in memory.
- To adjust the volume.

- To change the tone heard from the earpiece.

- To make/answer calls.
- To end a call.
- To end or exit from editing or other operations.
- To page the main unit and/or portable handset(s).
- To change the character input mode.
- To put a call on hold.
- To start a search in the Number Display log. (For caller ID display service users.)

Earpiece

Liquid crystal display

- ① Portable handset number (and name)
- ② No link to the base unit
- ③ Function menu that is controlled by **F1** or **F2**
- ④ Battery strength

How to use **F1** **F2** buttons

F1 and **F2** buttons refer to the function displayed on the bottom of the display. They function differently depending on the mode.

Dial buttons

- To switch to tone dialing.
- Sharp button

Microphone

(Do not cover the microphone while talking.)

- For call waiting service users.
- To clear letters/numbers.
- To change your voice.
- To mute your voice to the other party by pressing this button for about 2 seconds. (To release the mute, press this button again.)
- To use the speakerphone.

Installations and connections

Installing the ink film

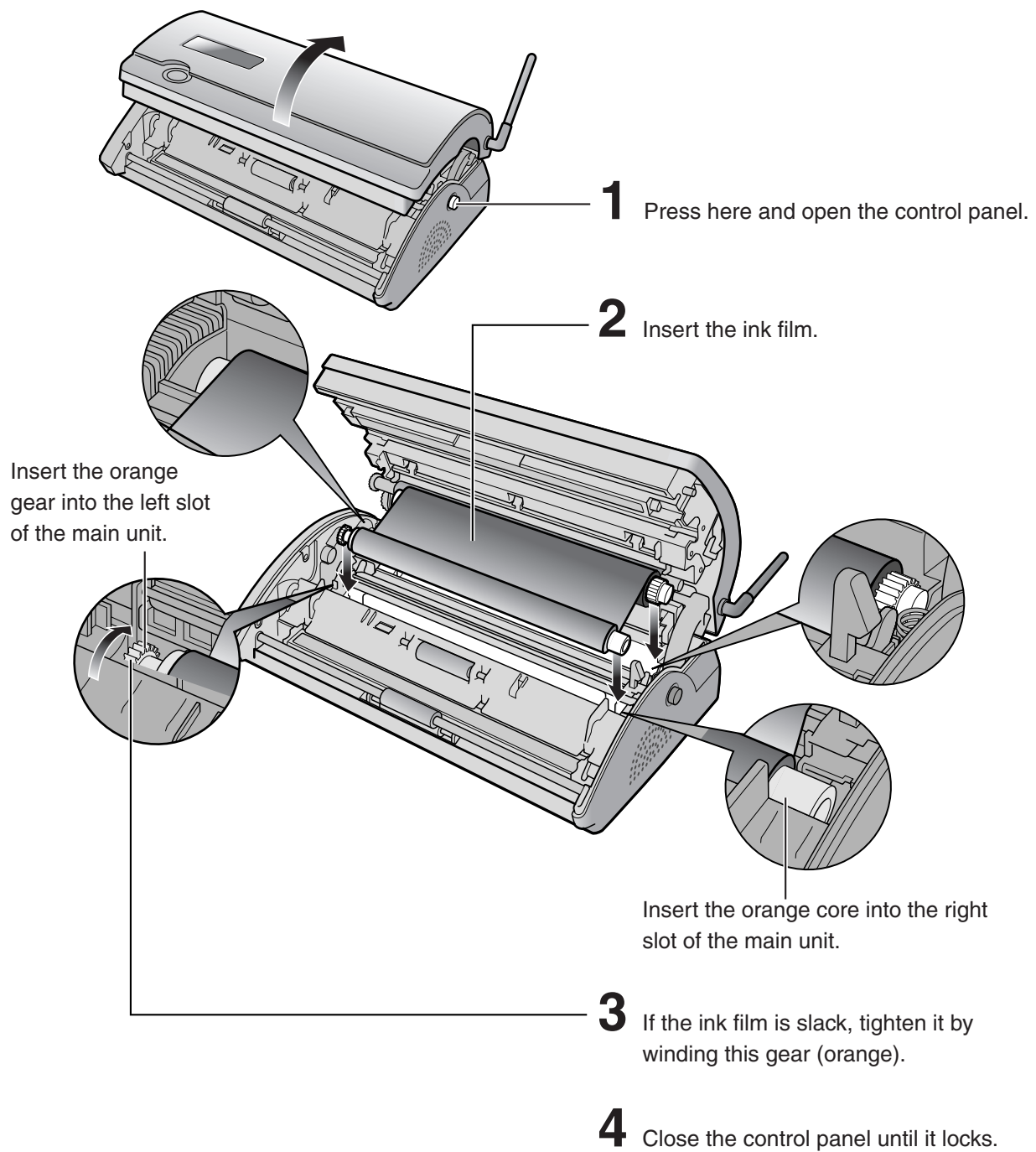

- When the unit runs out of ink film, the following message will be displayed.

フィルムカ ナクナリマシタ
コウカンシテクタサイ U23



フィルムカ ナクナリマシタ
ヒンバン : KX-FAN200

Install a new ink film.

Replacement ink film:
KX-FAN200 (30 m) ¥1,208

· As of February 2005.

· Tax included.

Installations and connections

Installing recording paper (A4 size)

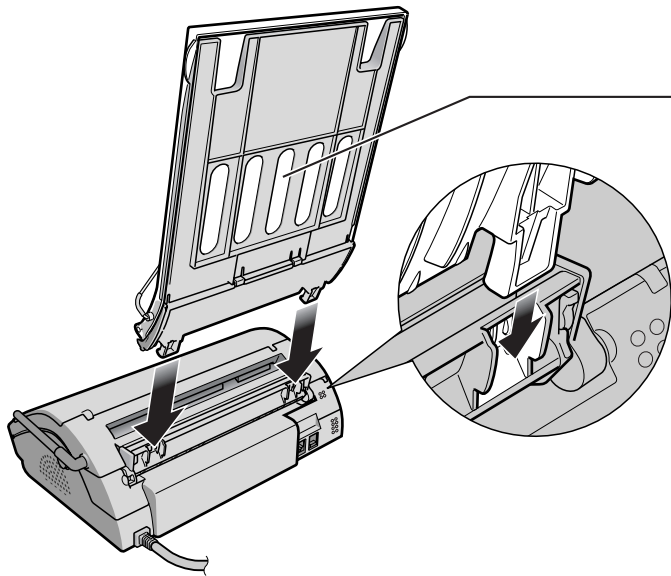

1 Install the recording paper cover/tray.

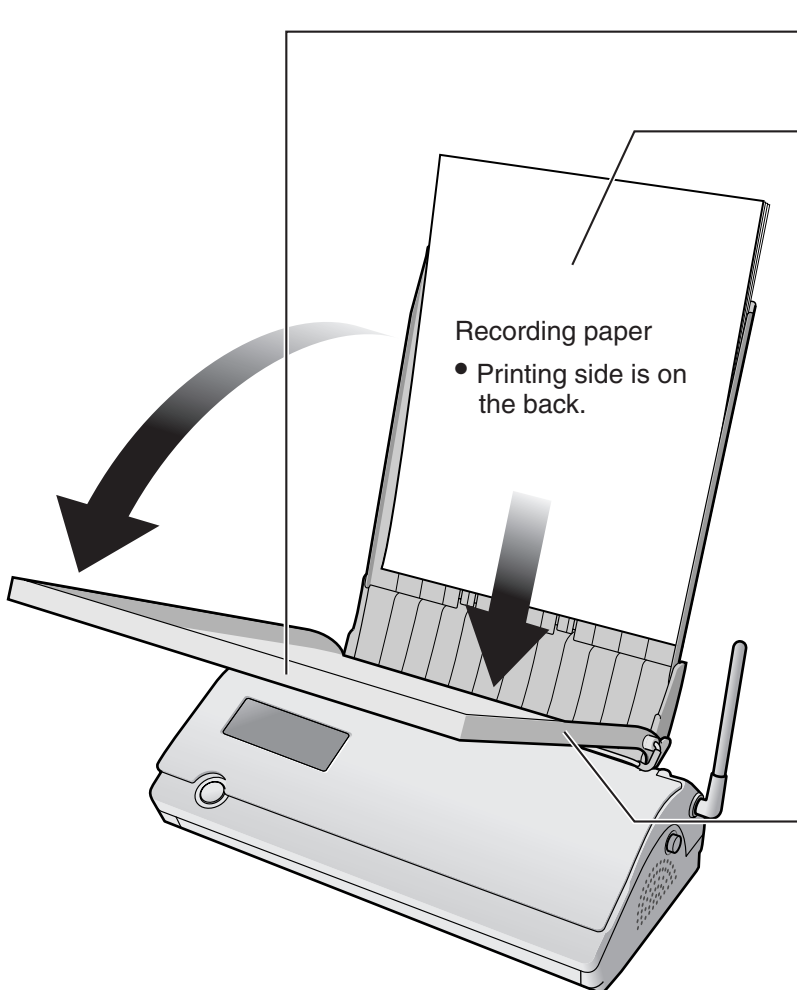

2 Open the recording paper cover.

3 Insert the recording paper into the recording paper tray. (Up to 20 sheets)

- Fan the stack of recording paper.

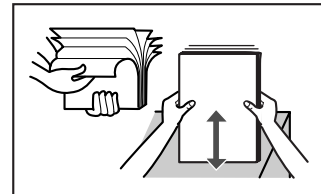

4 Close the recording paper cover.

Installations and connections

Connecting the main unit

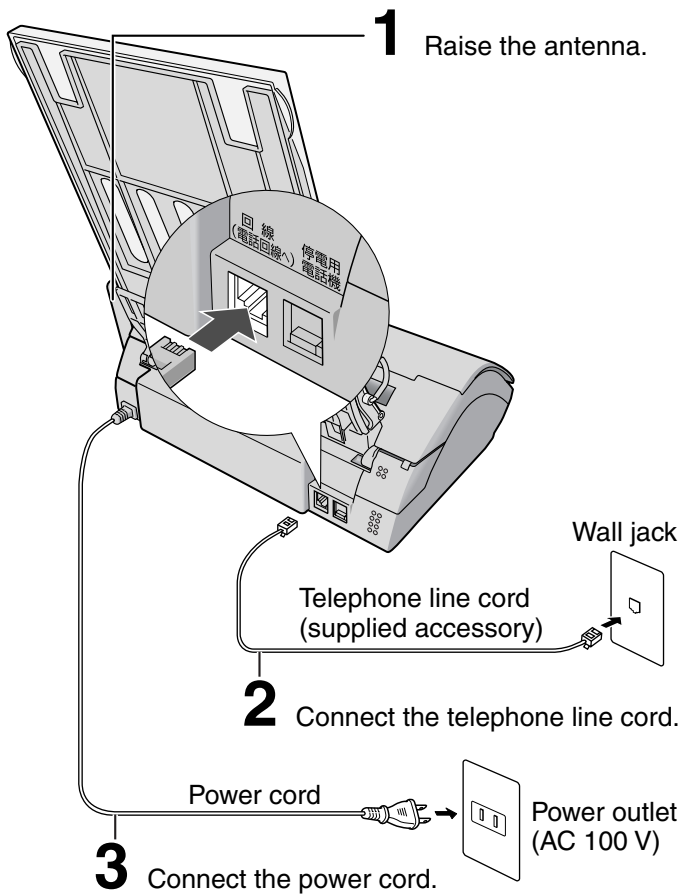

After the Power On...

This unit will automatically select the dialing mode (Tone/Pulse).

↓ If you can not make a call...

Set the dialing mode with the main unit.

1. Press (Function/Edit).
2. Press .
3. Press (Search button) repeatedly until the desired setting is displayed.

Example :

カイセンシユハツ=20 [◀▶, ケツテイ] オス	● フツシユ : Tone
	20 : Pulse (20 PPS)
	10 : Pulse (10 PPS)

4. Press (Set).

5. Press (Stop).

Setting up the portable handset (KX-FKN521)

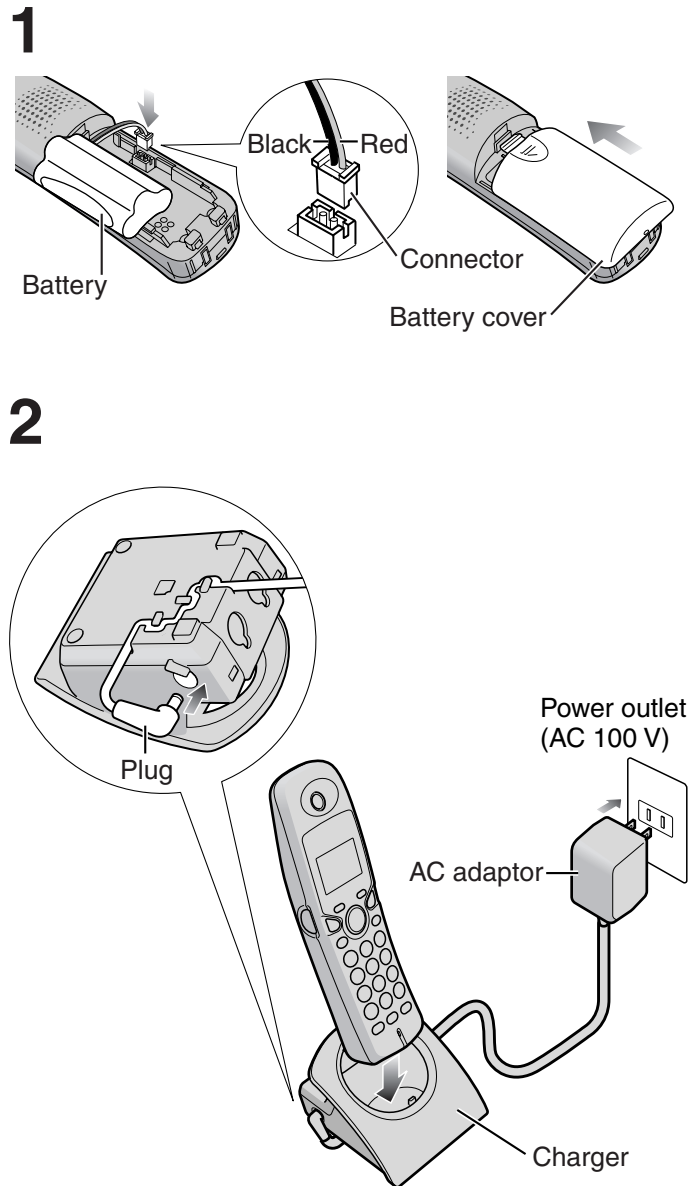

Setting the date and time

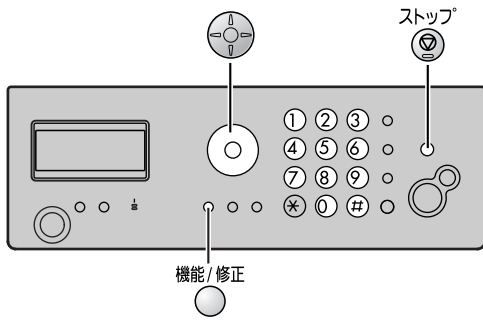

1 Press **機能/修正** (Function/Edit).

キノウ トウロク モード
[▼▲]オス

2 Press **# 0 0 1**.

Example : 2005年06月01日
20:10
Cursor

3 Enter the correct year/month/day.

Example: October 1, 2005

Press **2 0 0 5 1 0 0 1**.

2005年10月01日
20:10

4 Enter the correct hour/minute in a 24-hour clock entry.

Example: 15:45 (3:45 PM)

Press **1 5 4 5**.

2005年10月01日
15:45

5 Press **決定** (Set).

トウロク シマシタ



2005年10月01日
15:45

6 Press **ストップ** (Stop).

Example : 10月 1日 15:45
ヨウケン ロクオン 00ケン

Setting your facsimile telephone number

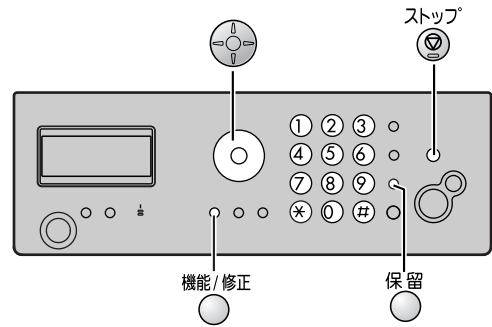

1 Press **機能/修正** (Function/Edit).

キノウ トウロク モード
[▼▲]オス

2 Press **# 0 0 4**.

アナタノテレホンバツゴウ?
TEL=.....
Cursor

3 Enter your facsimile telephone number, up to 20 digits.

Example: 098 765 43..

アナタノテレホンバツゴウ?
TEL=098 765 43..

The **保留** (Hold) button replaces the digit with a space.

4 Press **決定** (Set).

トウロク シマシタ



アナタノテレホンバツゴウ?
TEL=098 765 43..

5 Press **ストップ** (Stop).

Example : 10月 1日 15:45
ヨウケン ロクオン 00ケン

Setting your logo

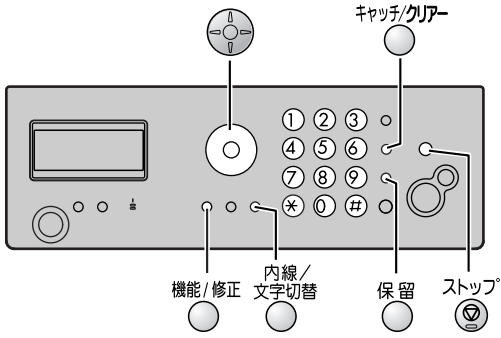

1 Press (Function/Edit).

キノウ トウロク モード
[▼▲]オス

2 Press .

アナタノナマイ?
Cursor

3 Enter your logo, up to 30 characters, using the dial keypad.

- To enter English characters easily, press (Intercom/Character input mode) repeatedly and select “英” (English and sign input mode).
- For details, see the table on page 9 for instructions.

Example: Micah

1. Press once.

アナタノナマイ?
M
Cursor

2. Press six times.

アナタノナマイ?
Mi

3. Press six times.

アナタノナマイ?
Mic

4. Press to move the cursor to the next space and press four times.

アナタノナマイ?
Mica

5. Press five times.

アナタノナマイ?
Micah

4 Press (Set).

トウロク シマシタ



アナタノナマイ?
Micah

5 Press (Stop).

Example : 10月 1日 15:45
ヨウケン ロクオン 00ケン

Character input and command key table

Pressing the dial keys will select a character as shown below.

Character		Katakana	English	Numbers
Display of the main unit		カナ	英	数
Display of the portable handset		[カナ]	[AB]	[12]
Dial key				
(Main unit)	(Portable handset KX-FKN521)			
①	①	アイウエオアイウエオ	@ . _ - & \$ ¥ % + = ~ ^	1
②	②	カキクケコ	A B C a b c	2
③	③	サシスセソ	D E F d e f	3
④	④	タチツテトツ	G H I g h i	4
⑤	⑤	ナニヌネノ	J K L j k l	5
⑥	⑥	ハヒフヘホ	M N O m n o	6
⑦	⑦	マミムメモ	P Q R S p q r s	7
⑧	⑧	ヤユヨヤユヨ	T U V t u v	8
⑨	⑨	ラリルレロ	W X Y Z w x y z	9
⑩	⑩	ワランー! ? ()	! ? / - * # , ; : · ' " () [] { } < > 「 」	0
✳	✳	” ° 、 。	、 。	
Command keys		内線/文字切替 (Main unit), 内線文字切替 (Portable handset)	Used to change the character input mode.	
		⬅ (Main unit), ⬆ (Portable handset)	Used to move the cursor to the left and right.	
		キャッチ/クリア (Main unit), クリア (Portable handset)	Used to delete a character.	
		保留 (Main unit), 保留 (Portable handset)	Used to insert a space.	

- The characters on the display are somewhat different from those shown in the character input and command key table.

Automatic dialing on the main unit

Storing names and telephone numbers in the phonebook

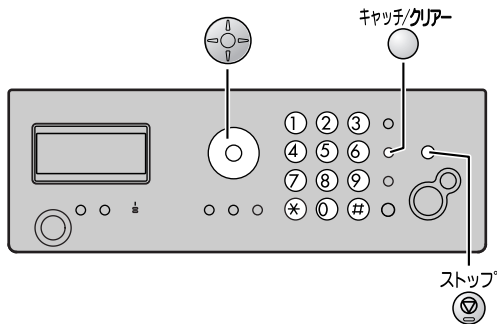

1 Press 電話帳 (Phonebook).

トウロク ハ [ケツテイ]オス
ケンサク ハ [▼▲]オス

2 Press 決定 (Set).

- "XXX" shows the remaining station numbers you can store.
- You can program up to 150 stations, including 4 pre-programmed stations.

テノンワチヨウ アキXXXケン

3 Enter the name, up to 12 characters (see the table on page 9 for instructions).

4 Press 決定 (Set).

5 Enter the telephone number, up to 24 digits.

- To correct a mistake, press キャッチ/クリア (Flash/Clear).

6 Press 決定 (Set).

7 Enter the group number (① to ⑨).

8 Press 決定 (Set).

- To program other items, repeat steps 3 to 8.

9 Press ストップ (Stop) to exit the program.

Making a voice call using the phonebook

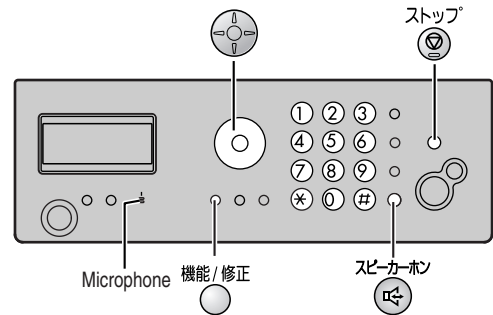

1 Press 電話帳 (Phonebook).

2 Press (Search button) repeatedly until the desired name is displayed.

3 Press スピーカーホン (Speakerphone).

- When the other party answers, speak to the microphone.

Editing a stored name or number in the phonebook

1 Press 電話帳 (Phonebook).

2 Press (Search button) repeatedly until the desired name is displayed.

3 Press 機能/修正 (Function/Edit).

4 Edit the name (see the table on page 9 for instructions).

- If you do not need to edit the name, skip to step 5.

5 Press 決定 (Set).

6 Edit the telephone number.

- If you do not need to edit the telephone number, skip to step 7.

7 Press 決定 (Set).

8 Edit the group number.

- If you do not need to edit the group number, skip to step 9.

9 Press 決定 (Set).

10 Press ストップ (Stop).

Automatic dialing on the portable handset (KX-FKN521)

Storing names and telephone numbers in the phonebook

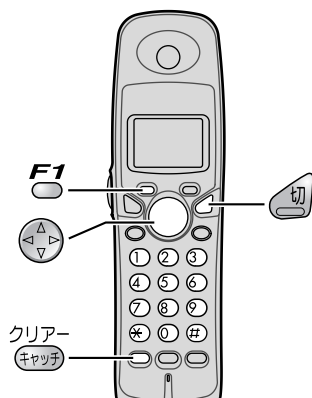

- 1 Press (Phonebook).

ケンサクハ	[▼▲]オス
-------	--------
- 2 Press .
 - “XXX” shows the remaining station numbers you can store.
 - You can program up to 150 stations, including 4 pre-programmed stations.

ナマイ?	[カナ]
アキ	×××ケン
- 3 Enter the name, up to 12 characters (see the table on page 9 for instructions).
- 4 Press .
- 5 Enter the telephone number, up to 24 digits.
 - To correct a mistake, press (Clear).
- 6 Press .
- 7 Enter the group number (① to ⑨).
- 8 Press .
- To program other items, repeat steps 3 to 8.
- 9 Press (Off) to exit the program.

Making a voice call using the phonebook

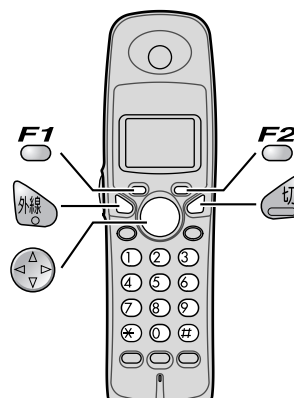

- 1 Press (Phonebook).
- 2 Press (Search button) repeatedly until the desired name is displayed.
- 3 Press (Talk).

Editing a stored name or number in the phonebook

- 1 Press (Phonebook).
- 2 Press (Search button) repeatedly until the desired name is displayed.
- 3 Press .
- 4 Edit the name (see the table on page 9 for instructions).
 - If you do not need to edit the name, skip to step 5.
- 5 Press .
- 6 Enter the correct telephone number.
 - If you do not need to edit the telephone number, skip to step 7.
- 7 Press .
- 8 Edit the group number.
 - If you do not need to edit the group number, skip to step 9.
- 9 Press .
- 10 Press (Off) to exit the program.

Intercom

An intercom is available between the portable handsets or between the main unit and portable handset(s).

Using the main unit:

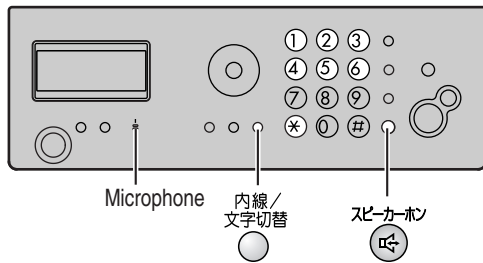

1 ■ For single portable handset users

Press  (Intercom/Character input mode).

コキ1 ヨビダシ チュウ

■ For multiple portable handset users

- 1 Press  (Intercom/Character input mode).
- 2 Call the portable handset(s) in the following ways:
 - To call a specific portable handset, press the portable handset number (1 to 6) which you want to call.
 - To call all the portable handsets, press *.

2 Start talking toward the microphone.

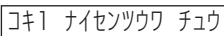
Example : 

3 Press  (Speakerphone) to end the intercom call.

Using the portable handset (KX-FKN521):

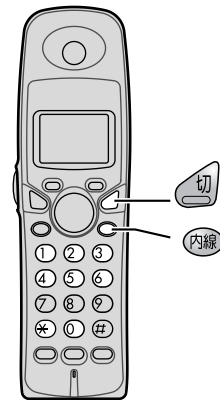

1 ■ For single portable handset users

Press  (Intercom).

■ For multiple portable handset users

- 1 Press  (Intercom).
- 2 Call the main unit and/or portable handset(s) in the following ways:
 - To call a specific portable handset, press the portable handset number (1 to 6) which you want to call.
 - To call the main unit, press 0.
 - To call the main unit and all the portable handsets, press *.

2 Start talking.

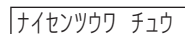



3 Press  (Off) to end the intercom call.

Sending faxes

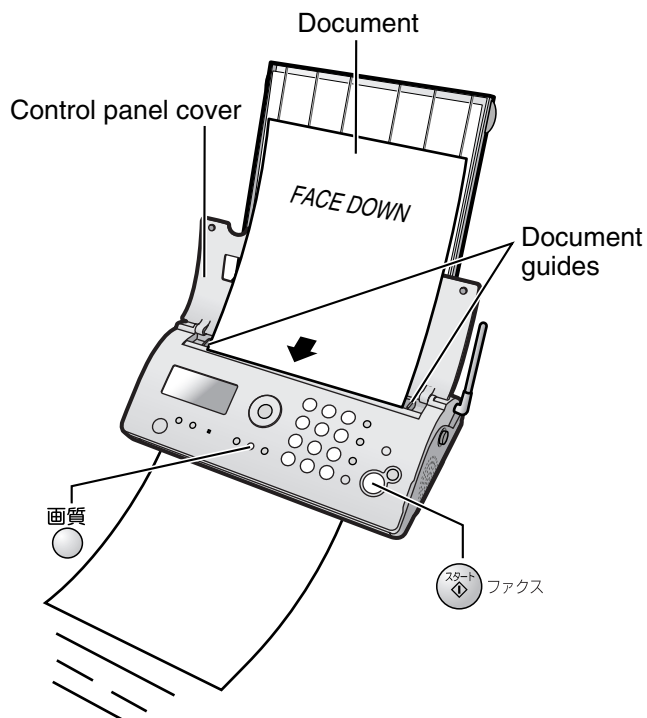

Sending a fax manually

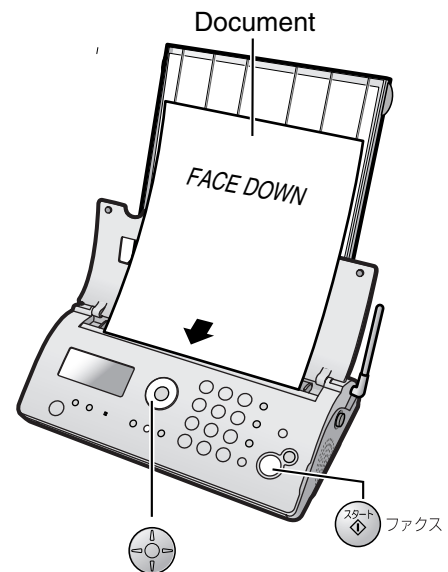

- 1 Open the control panel cover, and adjust the width of the document guides to the size of the document.
- 2 Insert the document (up to 5 pages) FACE DOWN until a single beep is heard.
- 3 If necessary, press  (Resolution) repeatedly to select the desired setting (see below).
- 4 Dial the fax number.
- 5 Press  (Start/Fax).
 - The unit will start fax transmission.

Sending a fax using the phonebook



- 1 Insert the document (up to 5 pages) FACE DOWN until a single beep is heard.
- 2 Press  (Phonebook).
- 3 Press  (Search button) repeatedly until the desired name is displayed.
- 4 Press  (Start/Fax).
 - The unit will start fax transmission.

To select the resolution

Select the desired resolution according to the type of document, by pressing  (Resolution).

カ ^レ シツ=フツウ	(Standard) for printed or typewritten originals with normal-sized characters.
カ ^レ シツ=チイサイ	(Fine) for originals with minute printing.
カ ^レ シツ=シャシヨ	(Photo) for originals containing photographs.

Receiving faxes

Receiving a fax manually (AUTO ANSWER off)

Using the main unit:

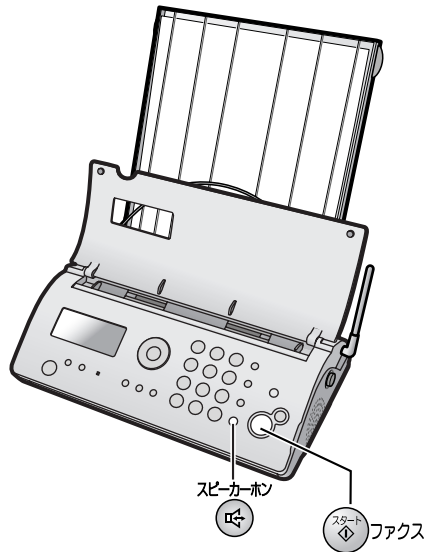



1 When you hear a ring, press  (Speakerphone) to answer the call.

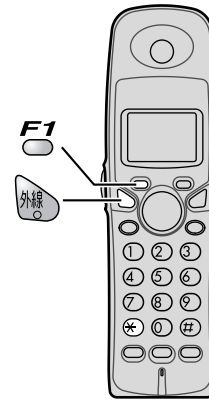

2 When:
– document reception is required,
– a fax calling tone (slow beep) is heard, or
– no sound is heard,
press  (Fax).

- The unit will start fax reception.

Using the portable handset (KX-FKN521):



1 When you hear a ring, lift the portable handset from the charger to answer the call.
• If the portable handset is not set on the charger, press  (Talk).



2 When:
– document reception is required,
– a fax calling tone (slow beep) is heard, or
– no sound is heard,
press , then press .

- The main unit will start fax reception.

Receiving faxes

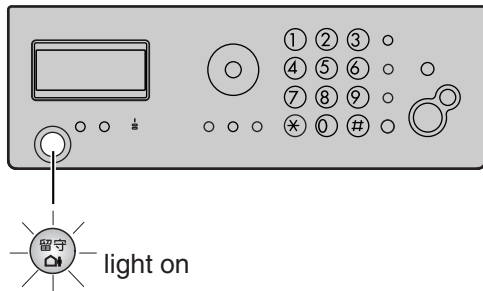
Receiving a fax automatically (AUTO ANSWER on)





- 1 If the  (Auto answer) light is off, turn it on by pressing .
- 2 When receiving a call, the unit will receive a fax document or record a voice message automatically depending on the caller's request.

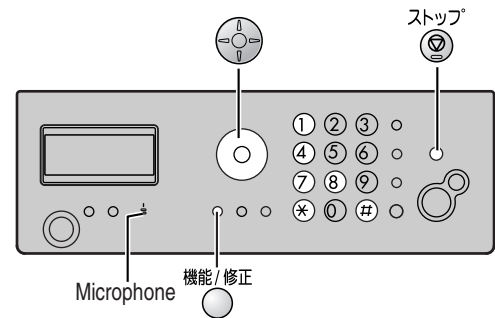

Operating the built-in answering device

Recording your own greeting message







You can record your own greeting message. When receiving a call, it will be played to callers instead of the pre-recorded Japanese greeting message.

- 1 Press  (Function/Edit).
- 2 Press .

ジ サク オウトウ ロクオン
[ケッテイ]オス
- 3 Press  (Set).
- 4 Press  (Set) and speak your greeting message after a beep, up to 16 seconds, to the microphone.
- 5 Press  (Stop).
 - Your greeting message will be played back automatically.

Erasing your own greeting message

- 1 Press  (Function/Edit).
- 2 Press .

ジ サク オウトウ ショウキョ
[ケッテイ]オス
- 3 Press  (Set).
- 4 Press .
 - The pre-recorded Japanese greeting message will be played when you receive a call.

Operating the built-in answering device

Activating the answering device

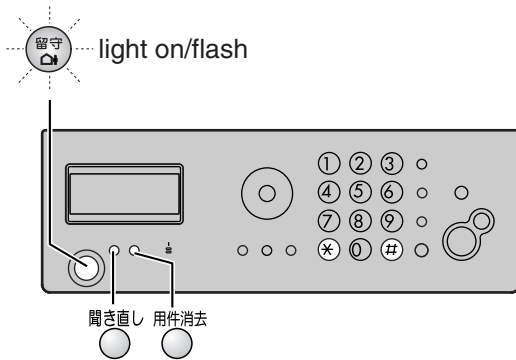

- 1 Turn the **留守** (Auto answer) light on by pressing **留守**.
- 2 When receiving a call, a greeting message will be played and the unit will record a voice message.
 - To record your own greeting message, see page 15.

Listening to recorded messages

When new messages are recorded, the **留守** (Auto answer) light will flash.

Press **留守** to listen to recorded messages.

After the messages are played back, the following will be displayed.

- To erase the messages, press *****.

サイセイシタヨウケンシヨウキヨ スル=* シナイ=#

- To save the messages, press **#**.

Listening to all of the recorded messages

Press **聞き直し** (Replay).

After the messages are played back, the following will be displayed.

- To erase the messages, press *****.

サイセイシタヨウケンシヨウキヨ スル=* シナイ=#

- To save the messages, press **#**.

Erasing a specific message

Press **用件消去** (Erase) while listening to the message you want to erase, then press *****.

Erasing all of the recorded messages

1 Press **用件消去** (Erase).

スハ`テ シヨウキヨシマスカ? ハイ=* イイエ=#

2 Press *****.

Operating the built-in answering device

Operating the answering device from a remote location

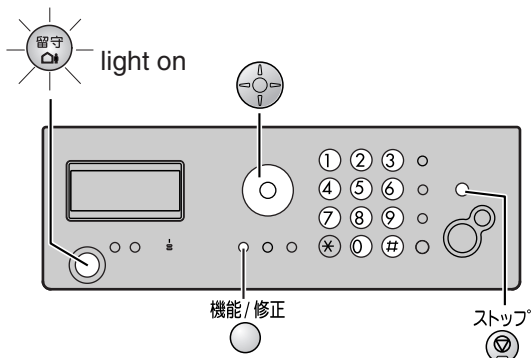

Preparation: Programming the remote operation ID

1. Press (Function/Edit).
2. Press .
3. Enter any 4-digit number (remote operation ID) except * or #.

Example :

アソショウ No.=1234
[4ケタ,ケツタイ]オス

4. Press (Set).
5. Press (Stop).

Operation: Listening to a recorded message from a remote location

Turn the (Auto answer) light on before you go out.

Remote operations are available only from a touch tone telephone.

1. Call your unit.
2. Enter the remote operation ID during the greeting message.
3. Press or wait 4 seconds.
 - Only the new recorded messages will be played back.
 - To listen to all the recorded messages, press after the new messages have been played back.

Specifications

KX-PW513DL KX-PW513DW	Main unit	Portable handset (KX-FKN521)	Battery charger
Power supply	AC 100 V (50 Hz/60 Hz)	Ni-MH battery (Part no. KX-FAN50) DC 3.6 V, 600 mAh	AC adaptor (Part no. PFAP1009) AC 100 V (50 Hz/60 Hz) DC 7.5 V, 100 mA
Power consumption	Transmission: Approx. 10 W Reception: Approx. 15 W Copy: Approx. 20 W Stand by: Approx. 1.0 W (When the F-net service is not in use.) Maximum(*1): Approx. 130 W		<ul style="list-style-type: none"> • Charging: Approx. 1.5 W • Stand by: Approx. 0.6 W
Dimensions (H x W x D)	Approx. 103 X 290 X 193 mm (without projections) Approx. 355.5 X 290 X 231 mm (recording paper cover/tray installed, without projections)	Approx. 161 X 47 X 39 mm	Approx. 64 X 80 X 90 mm
Mass (Weight)	Approx. 2.75 kg (10 m ink film installed)	Approx. 140 g (battery installed)	Approx. 80 g
Operating environment	5 °C – 35 °C, 45 % – 85 % RH (Relative Humidity)		

KX-PW513DL KX-PW513DW	Main unit
Applicable line	Public Switch Telephone Network (Tone/Pulse), F-Net, NCC Lines
DC resistance	320 Ω (*2)
Compatibility	G3 compatible
Document size	A4–A5 (Max. 216 mm in width, Max. 600 mm in length)
Effective scanning size	208 mm (A4)
Effective printing size	202 mm (A4 size plain paper)
Transmission time	Approx. 15 s/page (Original mode) (*3)
Modem speed	9,600 / 7,200 / 4,800 / 2,400 bps; Automatic fallback
Halftone level	64-level
Scanning density	Horizontal: 8 pels/mm Vertical : 7.7 lines/mm (Fine/Photo), 3.85 lines/mm (Standard)
Scanner type	Contact image sensor
Printer type	Thermal transfer printing on plain paper
Data compression system	Modified Huffman (MH), Original mode
Recording paper size	A4: 210 mm x 297 mm (Plain paper)
Answering device	Greeting message: Digital recording system (up to 16 sec) Pre-recording greeting message ICM Recording: Digital recording system (Approx. 18 min. in total) (*4)
Memory capacity	Max. Approx. 46 pages (Only receiving fax etc.) (*5) Max. Approx. 18 min. (Only Recording message) (*4)

*1 When copying a 100% black document.

*2 If you cannot make a call due to DC resistance, consult your dealer.

*3 Transmission speed is based on an A4-size document of 700 characters sent in standard resolution at 9,600 bps. The actual transmission speed depends upon the contents of the page, resolution, telephone line conditions and capability of the other party's machine.

*4 If there is a silent pause, the total recording time will be longer.

*5 The memory capacity is based on an A4-size document of 700 characters.

Free Manuals Download Website

<http://myh66.com>

<http://usermanuals.us>

<http://www.somanuals.com>

<http://www.4manuals.cc>

<http://www.manual-lib.com>

<http://www.404manual.com>

<http://www.luxmanual.com>

<http://aubethermostatmanual.com>

Golf course search by state

<http://golfingnear.com>

Email search by domain

<http://emailbydomain.com>

Auto manuals search

<http://auto.somanuals.com>

TV manuals search

<http://tv.somanuals.com>