

TOSHIBA

Owner's Manual

LCD Color Television

COLORSTREAM[®] HD

SRS
WOW

HDMI HDTV
MONITOR

26HL57

32HL57

37HL57

42HL57

For an overview of steps for setting up your new TV, see page 7.

A high definition tuner and programming are required to view High Definition TV broadcasts. Please contact your cable or satellite provider.

Owner's Record

The model number and serial number are on the back of your TV. Record these numbers in the spaces below. Refer to these numbers whenever you communicate with your Toshiba dealer about this TV.

Model number:

Serial number:

Dear Customer,

Thank you for purchasing this Toshiba LCD TV. This manual will help you use the many exciting features of your new LCD TV. **Before operating your LCD TV, please read this manual completely**, and keep it nearby for future reference.

Safety Precautions

WARNING: TO REDUCE THE RISK OF FIRE OR ELECTRIC SHOCK, DO NOT EXPOSE THIS APPLIANCE TO RAIN OR MOISTURE.

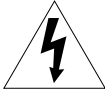

WARNING
RISK OF ELECTRIC SHOCK
DO NOT OPEN.



WARNING: TO REDUCE THE RISK OF ELECTRIC SHOCK, DO NOT REMOVE COVER (OR BACK). NO USER-SERVICEABLE PARTS INSIDE. REFER SERVICING TO QUALIFIED SERVICE PERSONNEL.



The lightning flash with arrowhead symbol, within an equilateral triangle, is intended to alert the user to the presence of uninsulated "dangerous voltage" within the product's enclosure that may be of sufficient magnitude to constitute a risk of electric shock to persons.



The exclamation point within an equilateral triangle is intended to alert the user to the presence of important operating and maintenance (servicing) instructions in the literature accompanying the appliance.

WARNING

To prevent injury, this apparatus must be securely attached to the floor/wall in accordance with the installation instructions. See item 20 on page 3.

WARNING: If you decide to wall mount this television, always use a UL Listed wall bracket appropriate for the size and weight of this television. The use of any wall bracket other than a UL Listed wall bracket appropriate for the size and weight of this television for wall mounting this television could result in serious bodily injury and/or property damage. See "Removing the Pedestal Stand" (page 5).

Child Safety

It Makes A Difference Where Your TV Stands



Congratulations on your purchase! As you enjoy your new TV, keep these safety tips in mind:

The Issue

- If you are like most consumers, you have a TV in your home. Many homes, in fact, have more than one TV.
- The home theater entertainment experience is a growing trend, and larger TVs are popular purchases; however, they are not always supported on the proper TV stands.
- Sometimes TVs are improperly secured or inappropriately situated on dressers, bookcases, shelves, desks, audio speakers, chests, or carts. As a result, TVs may fall over, causing unnecessary injury.



Toshiba Cares!

- The consumer electronics industry is committed to making home entertainment enjoyable and safe.
- The Consumer Electronics Association formed the Home Entertainment Support Safety Committee, comprised of TV and consumer electronics furniture manufacturers, to advocate children's safety and educate consumers and their families about television safety.

Tune Into Safety

- One size does NOT fit all! Use appropriate furniture large enough to support the weight of your TV (and other electronic components).
- Use appropriate angle braces, straps, and anchors to secure your furniture to the wall (but never screw anything directly into the TV).
- Carefully read and understand the other enclosed instructions for proper use of this product.
- Do not allow children to climb on or play with furniture and TVs.
- Avoid placing any item on top of your TV (such as a VCR, remote control, or toy) that a curious child may reach for.
- Remember that children can become excited while watching a program and can potentially push or pull a TV over.
- Share our safety message about this hidden hazard of the home with your family and friends. Thank you!



2500 Wilson Blvd.
Arlington, VA 22201 U.S.A.
www.CE.org

CEA is the Sponsor, Producer and
Manager of the International CES®

Important Safety Instructions

- 1) **Read these instructions.**
 - 2) **Keep these instructions.**
 - 3) **Heed all warnings.**
 - 4) **Follow all instructions.**
-
- 5) **Do not use this apparatus near water.**
 - 6) **Clean only with dry cloth.**
 - 7) **Do not block any ventilation openings.** Install in accordance with the manufacturer's instructions.
 - 8) **Do not install near any heat sources** such as radiators, heat registers, stoves, or other apparatus (including amplifiers) that produce heat.



- 9) **Do not defeat the safety purpose of the polarized or grounding type plug.** A polarized plug has two blades with one wider than the other. A grounding type plug has two blades and a third grounding prong. The wide blade or the third prong are provided for your safety. If the provided plug does not fit into your outlet, consult an electrician for replacement of the obsolete outlet.

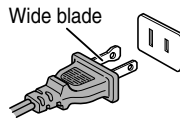

- 10) **Protect the power cord** from being walked on or pinched, particularly at plugs, convenience receptacles, and the point where they exit from the apparatus.

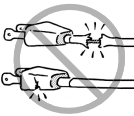

- 11) **Only use attachments/accessories specified by the manufacturer.**
- 12) **Use only with the cart, stand, tripod, bracket, or table specified by the manufacturer, or sold with the apparatus.** When a cart is used, use caution when moving the cart/apparatus combination to avoid injury from tip-over.



- 13) **Unplug this apparatus during lightning storms or when unused for long periods of time.**
- 14) **Refer all servicing to qualified service personnel.** Servicing is required when the apparatus has been damaged in any way, such as power-supply cord or plug is damaged, liquid has been spilled or objects have fallen into the apparatus, the apparatus has been exposed to rain or moisture, does not operate normally, or has been dropped.

Additional Safety Precautions

- 14a) **CAUTION:** If the TV is dropped and the cabinet or enclosure surface has been damaged or the TV does not operate normally, take the following precautions:
 - ALWAYS turn off the TV and unplug the power cord to avoid possible electric shock or fire.
 - NEVER allow your body to come in contact with any broken glass or liquid from the damaged television. The LCD panel inside the TV contains glass and a toxic liquid. If the liquid comes in contact with your mouth or eyes, or your skin is cut by broken glass, rinse the affected area thoroughly with water and consult your doctor.
 - ALWAYS contact a service technician to inspect the TV any time it has been damaged or dropped.

- 15) **CAUTION:**
 - To reduce the risk of electric shock, do not use the polarized plug with an extension cord, receptacle, or other outlet unless the blades can be inserted completely to prevent blade exposure.
 - To prevent electric shock, match wide blade of plug to wide slot; fully insert.
- 16) **WARNING:** To prevent the spread of fire, keep candles or other open flames away from this product at all times.

Installation, Care, and Service

Installation

Follow these recommendations and precautions and heed all warnings when installing your TV:

- 17) Never modify this equipment. Changes or modifications may void the warranty.
- 18) **DANGER: RISK OF SERIOUS PERSONAL INJURY, DEATH, OR EQUIPMENT DAMAGE!** Never place the TV on an unstable cart, stand, or table. The TV may fall, causing serious personal injury, death, or serious damage to the TV. 
- 19) To avoid damage to this product, never place or store the TV in direct sunlight; hot, humid areas; or areas subject to excessive dust or vibration.
- 20) Always place the TV on the floor or a sturdy, level, stable surface that can support the weight of the unit. To secure the TV, use a sturdy tie from the hooks on the rear of the TV pedestal to a wall, pillar, or other immovable structure. Make sure the tie is tight, secure, and parallel to the floor.

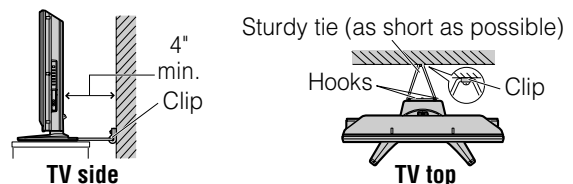

- 21) The apparatus shall not be exposed to dripping or splashing and that no objects filled with liquids, such as vases, shall be placed on the apparatus.
- 22) Never block or cover the slots or openings in the TV cabinet back, bottom, and sides. Never place the TV:
 - on a bed, sofa, rug, or similar surface;
 - too close to drapes, curtains, or walls; or
 - in a confined space such as a bookcase, built-in cabinet, or any other place with poor ventilation.

The slots and openings are provided to protect the TV from overheating and to help maintain reliable operation of the TV. Leave a space of at least 4 (four) inches around the TV.

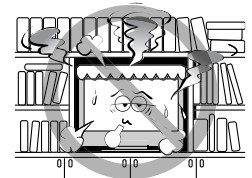

(continued)

- 23) Always place the back of the television at least four (4) inches away from any vertical surface (such as a wall) to allow proper ventilation.
- 24) Never allow anything to rest on or roll over the power cord, and never place the TV where the power cord is subject to wear or abuse.
- 25) Never overload wall outlets and extension cords.
- 26) Always operate this equipment from a 120 VAC, 60 Hz power source only.
- 27) Always make sure the antenna system is properly grounded to provide adequate protection against voltage surges and built-up static charges (see Section 810 of the National Electric Code).

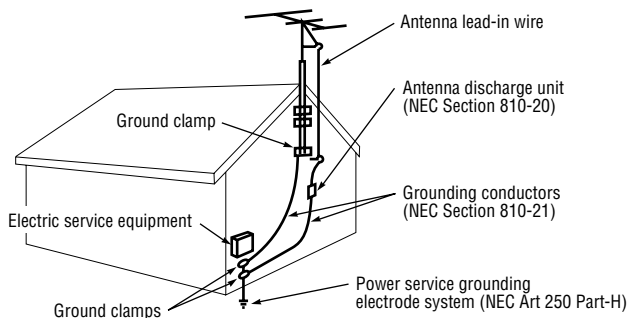

28)  **DANGER: RISK OF SERIOUS PERSONAL INJURY OR DEATH!**



- Use extreme care to make sure you are never in a position where your body (or any item you are in contact with, such as a ladder or screwdriver) can accidentally touch overhead power lines. Never locate the antenna near overhead power lines or other electrical circuits.
- Never attempt to install any of the following during lightning activity: a) an antenna system; or b) cables, wires, or any home theater component connected to an antenna or phone system.

Care

For better performance and safer operation of your TOSHIBA TV, follow these recommendations and precautions:

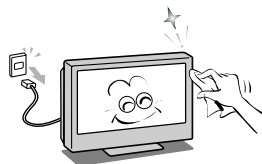
- 29) If you use the TV in a room whose temperature is 32 °F (0 °C) or below, the picture brightness may vary until the LCD warms up. This is not a sign of malfunction.
- 30) Always unplug the TV before cleaning. Gently wipe the display panel surface (the TV screen) using a dry, soft cloth only (cotton, flannel, etc.). A hard cloth may damage the surface of the panel. Avoid contact with alcohol, thinner, benzene, acidic or alkaline solvent cleaners, abrasive cleaners, or chemical cloths, which may damage the surface. Never spray volatile compounds such as insecticide on the cabinet. Such products may damage or discolor the cabinet.



- 31)  **WARNING: RISK OF ELECTRIC SHOCK!** 
Never spill liquids or push objects of any kind into the TV cabinet slots.

- 32) While it is thundering, do not touch the connecting cables or apparatus.
- 33) For added protection of your TV from lightning and power surges, always unplug the power cord and disconnect the antenna from the TV if you leave the TV unattended or unused for long periods of time.
- 34) During normal use, the TV may make occasional snapping or popping sounds. This is normal, especially when the unit is being turned on or off. If these sounds become frequent or continuous, unplug the power cord and contact a Toshiba Authorized Service Center.



- 35)  **WARNING: RISK OF SERIOUS PERSONAL INJURY OR EQUIPMENT DAMAGE!**

Never strike the screen with a sharp or heavy object.



- 36) • The LCD screen of this product can be damaged by ultraviolet radiation from the sun. When selecting a location for the television, avoid locations where the screen may be exposed to direct sunlight, such as in front of a window.
- Never touch, press, or place anything on the LCD screen. These actions will damage the LCD screen. If you need to clean the LCD screen, follow the instructions in item 30 on this page.

Service

- 37)  **WARNING: RISK OF ELECTRIC SHOCK!** 
Never attempt to service the TV yourself. Opening and removing the covers may expose you to dangerous voltage or other hazards. Failure to follow this WARNING may result in death or serious injury. Refer all servicing not specified in this manual to a Toshiba Authorized Service Center.

- 38) If you have the TV serviced:
- Ask the service technician to use only replacement parts specified by the manufacturer.
 - Upon completion of service, ask the service technician to perform routine safety checks to determine that the TV is in safe operating condition.
- 39) The cold cathode fluorescent lamp in the LCD panel contains a small amount of mercury. When the TV reaches the end of its useful life, dispose of the used TV by the approved method for your area, or ask a qualified service technician to properly dispose of the TV.

Choosing a location for your LCD TV

To Display your LCD TV on the included Pedestal Stand:

Observe the following safety precautions:

- 1) Read and Follow the pedestal assembly instructions included with the pedestal.

CAUTION: Before beginning pedestal assembly, carefully lay the front of the LCD Panel face down on a flat, cushioned surface such as a quilt or blanket. Leave the bottom of the unit protruding over the edge of the surface and assemble pedestal as indicated below.

Note: Extreme care should always be used when attaching the pedestal stand to avoid damage to the LCD panel.

- 2) Place the TV on a sturdy, level surface that can support the weight of the TV.
- 3) Be sure to secure the TV to a wall, pillar, surface, or other immovable structure. To secure the TV in this manner, use the included strap located at the rear of the pedestal stand. (☞ item 20, page 3).

To Display your LCD TV using a Wall Bracket:

If you decide to wall mount your LCD TV, always use a UL-listed wall bracket appropriate for the size and weight of the LCD TV (☞ page 2) :

- 1) **CAUTION:** Two people are required for installation.
- 2) Unplug and remove any cables and/or other component connectors from the rear of the TV.
- 3) Follow the instructions provided with your wall bracket. Before proceeding, make sure the appropriate bracket(s) are attached to the wall and the back of the TV as described in the instructions provided with the wall bracket.
- 4) After attaching the appropriate bracket(s) to the wall and the back of the TV, remove the pedestal stand from the TV as described below.

Removing the Pedestal Stand

- 1) Carefully lay the front of the unit face down on a flat, cushioned surface such as a quilt or blanket. Leave the stand protruding over the edge of the surface.

Note: Extreme care should always be used when removing the pedestal stand to avoid damage to the LCD panel.

- 2) Remove the jack pack cover on the back of the TV to expose the pedestal stand screws. The jack pack cover can be removed without tools.
- 3) Remove the five screws shown in the diagram below. This will allow removal of the pedestal stand.
- 4) Once you have removed all five screws holding the pedestal stand in place, remove the pedestal stand from the TV by sliding the pedestal stand away from the TV.

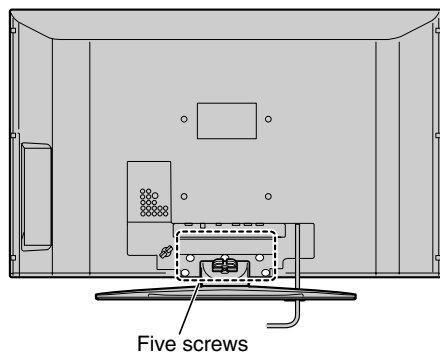

Important notes about your LCD TV

The following symptoms are technical limitations of LCD Display technology and are not an indication of malfunction; therefore, Toshiba is not responsible for perceived issues resulting from these symptoms.

- 1) An afterimage (ghost) may appear on the screen if a fixed, non-moving image is displayed for a long period of time. The afterimage is not permanent and will disappear in a short period of time.
- 2) The LCD panel contained in this TV is manufactured using an extremely high level of precision technology; however, there may be an occasional pixel (dot of light) that does not operate properly (does not light, remains constantly lit, etc.). This is a structural property of LCD technology, is not a sign of malfunction, and is not covered under your warranty. Such pixels are not visible when the picture is viewed from a normal viewing distance.

Note: Interactive video games that involve shooting a "gun" type of joystick at an on-screen target may not work with this TV.

Trademark Information

- WOW, SRS and ● symbol are trademarks of SRS Labs, Inc. WOW technology is incorporated under license from SRS Labs, Inc.
- HDMI, the HDMI logo and High-Definition Multimedia Interface are trademarks or registered trademarks of HDMI Licensing LLC.

Contents

Chapter 1: Introduction	7	Adjusting the picture.	35
Welcome to Toshiba	7	Selecting the picture mode	35
Features of your new TV	7	Adjusting the picture quality	35
Overview of steps for installing, setting up, and		Using the black stretch feature	36
using your new TV	7	Using MPEG noise reduction	36
TV front and side panel controls and connections	8	Using CableClear®/DNR (digital noise reduction)	36
TV back panel connections	9	Selecting the color temperature	37
Chapter 2: Connecting your TV	10	Using the closed caption mode	37
Overview of cable types	10	Closed Caption Reception Adjustment	38
About the connection illustrations	10	Adjusting the audio	38
Connecting an antenna or cable TV	10	Muting the sound	38
Connecting a VCR and antenna or Cable TV		Selecting stereo/SAP broadcasts	38
(no Cable box)	11	Adjusting the audio quality	39
Connecting a VCR with S-video and a cable box	12	Using the SRS WOW™ surround sound feature	39
Connecting a DVD player with ColorStream® (component		Using the StableSound® feature	40
video), a VCR, and a satellite receiver	13	Using the Locks menu	40
Connecting a camcorder	14	Entering the PIN code	40
Connecting an audio system	14	If you cannot remember your PIN code	40
Connecting an HDMI™ or DVI device to the HDMI		Changing your PIN code	41
input	15	Locking channels	41
Connecting a personal computer (PC)	16	Using the Video lock feature	41
Chapter 3: Using the remote control	17	Using the PC settings feature	42
Preparing the remote control for use	17	Setting the PC Audio	42
Installing the remote control batteries	17	Setting the sleep timer	43
Remote control effective range	17	Setting the On timer	43
Learning about the remote control	18	Displaying TV setting information on-screen using	
Using the remote control to operate your other devices	19	RECALL	44
Remote Control functional key chart	20	Understanding the auto power off feature	44
Programming the remote control		Understanding the last mode memory feature	44
to operate your other devices	21	Chapter 7: Troubleshooting	45
Remote control codes	22	General troubleshooting	45
Chapter 4: Menu layout and navigation	24	Chapter 8: Appendix	47
Menu Layout	24	Specifications	47
Navigating the menu system	25	Limited Canadian Warranty for Toshiba Brand Flat Panel	
Chapter 5: Setting up your TV	26	Televisions	48
Selecting the menu language	26	Index	50
Programming channels into the TV's channel memory	26		
Programming channels automatically	26		
Manually adding and deleting channels			
in the channel memory	27		
Programming your favorite channels	27		
Labeling channels	28		
Setting the HDMI™ audio mode	29		
Chapter 6: Using the TV's features	30		
Selecting the video input source to view	30		
Labeling the video input sources	30		
Tuning channels	31		
Tuning your favorite channels	31		
Tuning to the next programmed channel	31		
Tuning to a specific channel (programmed or			
unprogrammed)	31		
Tuning to a specific programmed channel			
(or video mode) using the Program list	31		
Switching between two channels using Channel			
Return	31		
Selecting the picture size	31		
Adjusting the Picture Position	33		
Using the auto aspect ratio feature	33		
Using the blue screen function	34		
Selecting the gray level for 4:3 mode side panels	34		
Selecting the cinema mode (480i signals only)	34		

Chapter 1: Introduction

Welcome to Toshiba

Thank you for purchasing this Toshiba TV, one of the most innovative LCD TVs on the market.

This manual applies to models 26HL57, 32HL57, 37HL57, and 42HL57. The model and serial numbers are on the back of your TV. Write these numbers in the space provided on the front cover of this manual for your records.

Instructions in this manual are based on using the remote control. You can also use the controls on the TV if they have the same name as those on the remote control.

Please read all the safety and operating instructions carefully, and keep the manual for future reference.

Features of your new TV

The following are just a few of the many exciting features of your new Toshiba widescreen LCD TV:

- **Two sets of ColorStream® HD** high-resolution component video inputs (☞ pages 9 and 13).
- **Two HDMI™** digital, high-definition multimedia interfaces (☞ pages 9 and 15).
- **SRS WOW™** audio technologies (☞ page 39).
- **CableClear® DNR** digital picture noise reduction (☞ page 36).
- **PC IN (Analog RGB)** computer input (☞ pages 9 and 16).

Overview of steps for installing, setting up, and using your new TV

Follow these steps to set up your TV and begin using its many exciting features.

- 1** Carefully read the important safety, installation, care, and service information (☞ pages 2–4). Keep this manual for future reference.
- 2** Observe the following when choosing a location for the TV:
 - Place the TV on the floor or a sturdy, level, stable surface that can support the weight of the unit. Secure the TV to a wall, pillar, or other immovable structure (☞ page 3).
 - Place the TV in a location where light does not reflect on the screen.
 - Place the TV far enough from walls and other objects to allow proper ventilation. Inadequate ventilation may cause overheating, which will damage the TV. **THIS TYPE OF DAMAGE IS NOT COVERED UNDER THE TOSHIBA WARRANTY.**
- 3** Do not plug in any power cords until **AFTER** you have connected all cables and devices to your TV.
- 4** **BEFORE** connecting cables or devices to the TV, learn the functions of the TV's connections and controls (☞ pages 8–9).
- 5** Connect your other electronic device(s) to the TV (☞ pages 10–16).
- 6** Install the batteries in the remote control (☞ page 17).
- 7** See “Learning about the remote control” (☞ page 18) for an overview of the buttons on the remote control.
- 8** Programming the remote control to operate your other device(s) (☞ pages 19–23).
- 9** **AFTER** connecting all cables and devices, plug in the power cords for your TV and other devices. Press **POWER** on the TV control panel or remote control to turn on the TV.
- 10** See “Menu layout and navigation” for a quick overview of the TV's menu system (☞ page 24).
- 11** Program channels into the TV's channel memory (☞ page 26).
- 12** For details on using the TV's features, see Chapter 6.
- 13** For help, refer to the Troubleshooting section (☞ Chapter 7).
- 14** For technical specifications and warranty information, see Chapter 8.
- 15** Enjoy your new TV!

TV front and side panel controls and connections

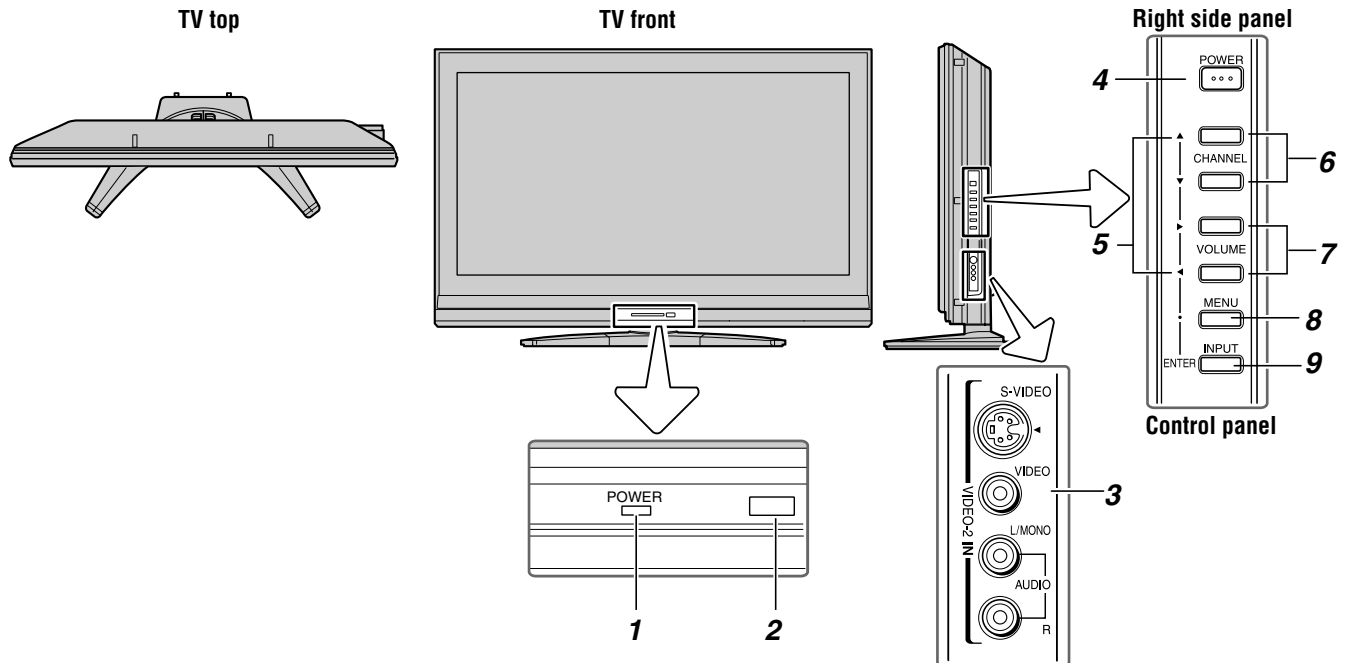

- 1 Green LED** — Green light indicates power is on.
- 2 Remote sensor** — Point the remote control toward the remote sensor. See “Remote control effective range” (page 17).
- 3 VIDEO-2 IN** — The side panel A/V connections are referred to as “**VIDEO 2**” and include standard A/V inputs plus an optional S-video input.
Note: Standard (composite) video and S-video cables carry only video information; separate audio cables are required for a complete connection.
- 4 POWER** — Press to turn the TV on and off.
- 5 ARROWS ▲▼◀▶** — When a menu is on-screen, these buttons function as up/down/left/right menu navigation buttons.
- 6 CHANNEL ▲▼** — When no menu is on-screen, these buttons change the channel (programmed channels only; page 26).
- 7 VOLUME ◀▶** — When no menu is on-screen, these buttons adjust the volume level.
- 8 MENU** — Press to access the menu system (page 24).
- 9 INPUT (ENTER)** — Repeatedly press to change the source you are viewing (**Video1/ColorStream HD1, Video2, ColorStream HD2, HDMI1, HDMI2, PC, or antenna/cable channel**).
When a menu is on-screen, the **INPUT** button on the TV’s control panel functions as the **ENTER** button.

TV back panel connections

For an explanation of cable types and connections, see Chapter 2 (🔗 page 10).

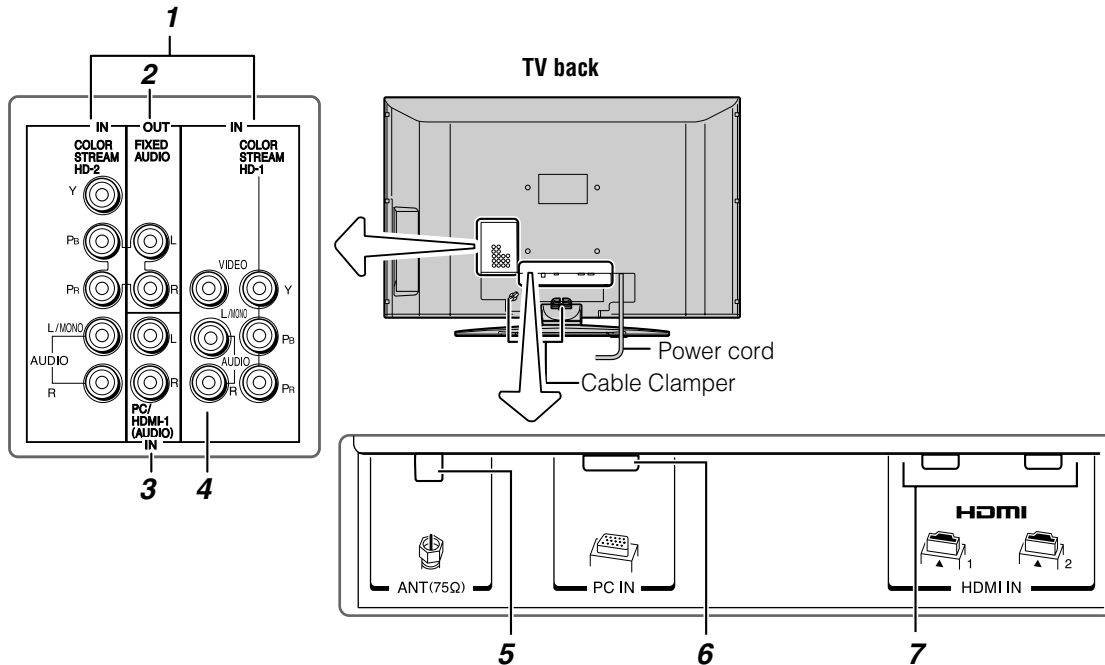

- 1 ColorStream® HD-1 and ColorStream® HD-2** — Two sets of ColorStream® high-definition component video inputs (with standard analog audio inputs) for connecting devices with component video output, such as a Toshiba DVD player with ColorStream®.

Note: Component video cables carry only video information; separate audio cables are required for a complete connection.

- 2 Fixed Audio OUT** — Analog audio outputs for connecting an audio amplifier.
- 3 PC/HDMI-1 (AUDIO) IN** — PC audio input terminals are shared with HDMI1 analog audio input terminals, and their use can be configured in the **Set Up** menu (🔗 page 42).
- 4 VIDEO-1 IN** — Standard (composite) video and standard (analog) audio inputs for connecting devices with composite video output.

Note: VIDEO-1 input terminals are shared with ColorStream HD-1 input terminals. When component video cables are connected to the ColorStream HD-1 terminals and ColorStream HD-1 is the current input mode, the VIDEO-1 input terminals will not carry any signals.

- 5 ANT** — Antenna input that supports analog (NTSC) antenna signals and analog cable TV signals.
- 6 PC IN** — For use when connecting a personal computer (🔗 page 16).
- 7 HDMI™ IN** — High-Definition Multimedia Interface input receives digital audio and uncompressed digital video from an HDMI device, or uncompressed digital video from a DVI device (🔗 item 3, at left; also 🔗 page 15).

HDMI, the HDMI logo and High-Definition Multimedia Interface are trademarks or registered trademarks of HDMI Licensing LLC.

Chapter 2: Connecting your TV

Overview of cable types

Cables can be purchased from most stores that sell audio/video devices. Before purchasing any cables, be sure of connector types required by your devices and the length of each cable.

Coaxial (F-type) cable



Coaxial (F-type) cable is used for connecting your antenna, cable TV service, and/or cable converter box to the **ANT** input on your TV.

Standard A/V cables (red/white/yellow)

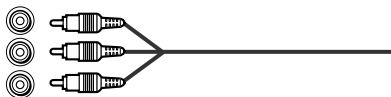

Standard A/V cables (composite video) usually come in sets of three, and are for use with video devices with analog audio and composite video output. These cables (and the related inputs on your TV) are typically color-coded according to use: yellow for video, red for stereo right audio, and white for stereo left (or mono) audio.

S-video cable



S-video cable is for use with video devices with S-video output. Separate audio cables are required for a complete connection.

Note: An S-video cable provides better picture performance than a composite video cable. If you connect an S-video cable, be sure to disconnect the standard (composite) video cable or the picture performance will be unacceptable.

Component video cables (red/green/blue)

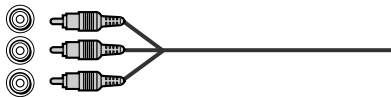

Component video cables come in sets of three and are for use with video devices with component video output. (ColorStream® is Toshiba's brand of component video.) These cables are typically color-coded red, green, and blue. Separate audio cables are required for a complete connection.

Note: Component video cables provide better picture performance than a standard (composite) video or S-video cable.

HDMI™ cable



HDMI (High-Definition Multimedia Interface) cable is for use with devices with an HDMI output. An HDMI cable delivers digital audio and video in its native format. This cable carries both video and audio information; therefore, separate audio cables are not required for a complete HDMI device connection (see page 15).

Note: HDMI cable provides better picture performance than a standard (composite) video or S-video cable.

Analog RGB (15-pin) computer cable

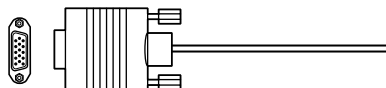

Analog RGB (15-pin) computer cable is for connecting a PC to the TV's **PC IN** terminal (see page 16).

About the connection illustrations

You can connect different types and brands of devices to your TV in several different configurations. The connection illustrations in this manual are representative of typical device connections only. The input/output terminals on your devices may differ from those illustrated herein. For details on connecting and using your specific devices, refer to each device's owner's manual.

Connecting an antenna or cable TV

This connection allows you to watch TV programs or basic cable channels.

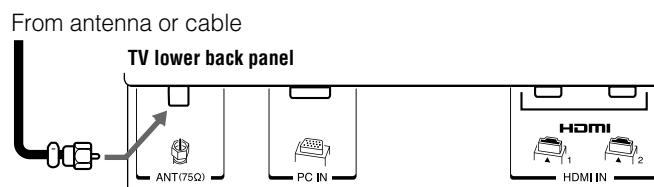

Connecting a VCR and antenna or Cable TV (no Cable box)

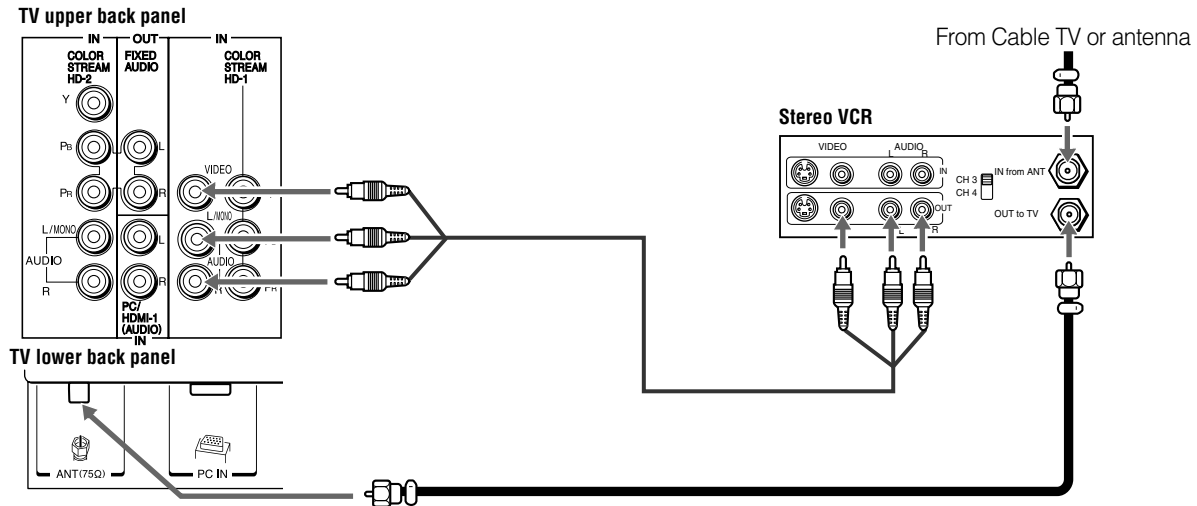

You will need:

- coaxial cables
- standard A/V cables
 - For better picture performance, if your VCR has S-video, connect an S-video cable and standard (analog) audio cables to the **VIDEO-2** inputs on the side panel (instead of the **VIDEO-1** inputs). Do not connect both types of video cable to **VIDEO-2** at the same time or the picture performance will be unacceptable.
 - If you have a mono VCR, connect **L/MONO** on the TV to your VCR's audio out terminal using the white audio cable only.

To view the antenna or Cable signal:

Select the **ANT** video input source on the TV.*

To view the VCR:

Turn ON the VCR. Select the **Video1** video input source on the TV.*

* To select the video input source, press **INPUT** on the remote control (page 30). To program the TV remote control to operate other devices, see Chapter 3.

The unauthorized recording, use, distribution, or revision of television programs, videotapes, DVDs, and other materials is prohibited under the Copyright Laws of the United States and other countries, and may subject you to civil and criminal liability.

Connecting a VCR with S-video and a cable box

An S-video connection will provide better picture performance than a standard (composite) video cable.

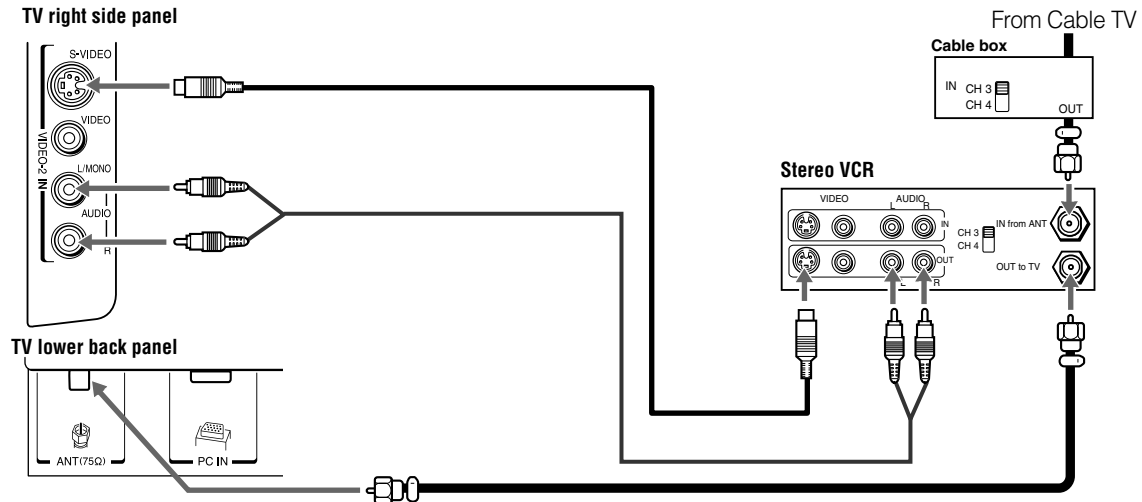

You will need:

- coaxial cables
- S-video cable
 - Do not connect both types of video cable to **VIDEO-2** at the same time or the picture performance will be unacceptable.
- standard audio cables
 - If you have a mono VCR, connect **L/MONO** on the TV to your VCR's audio out terminal using the white audio cable only.

Note: When you use a Cable box, you may not be able to use the remote control to program or access certain features on the TV.

To view basic and premium Cable channels:

Turn OFF the VCR. Select the **ANT** video input source on the TV.* Tune the TV to channel 3 or 4 (whichever channel the Cable box output is set to). Use the Cable box controls to change channels.

To view the VCR:

Turn ON the VCR. Select the **Video2** video input source on the TV.*

* To select the video input source, press **INPUT** on the remote control (page 30). To program the TV remote control to operate other devices, see Chapter 3.

The unauthorized recording, use, distribution, or revision of television programs, videotapes, DVDs, and other materials is prohibited under the Copyright Laws of the United States and other countries, and may subject you to civil and criminal liability.

Connecting a DVD player with ColorStream® (component video), a VCR, and a satellite receiver

Your TV has two sets of ColorStream® (component video) inputs.

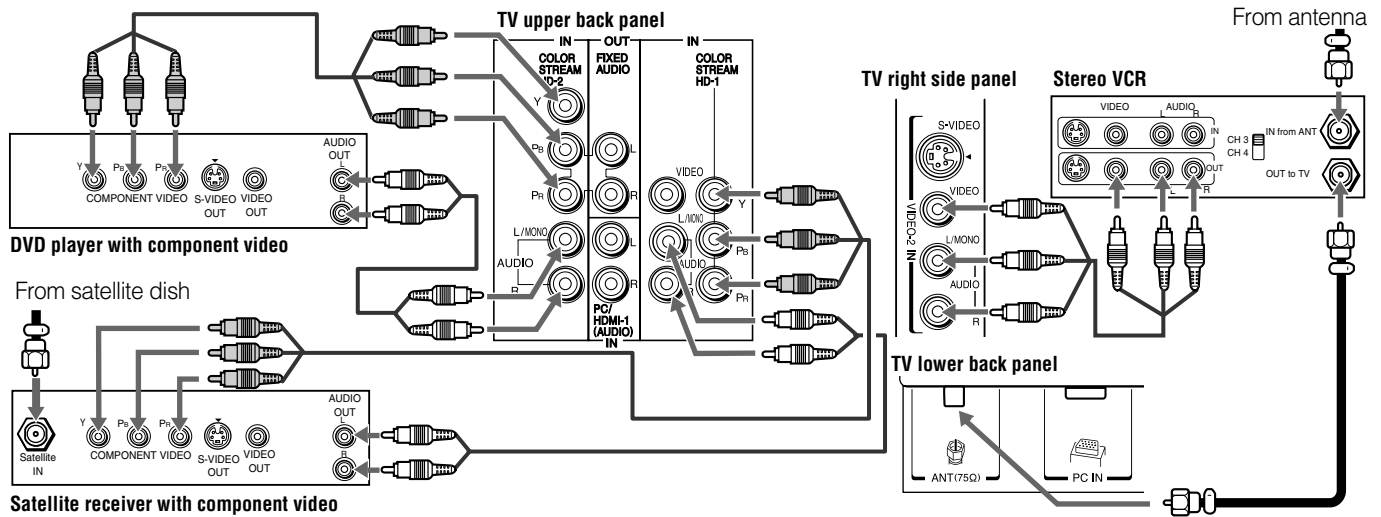

You will need:

- coaxial cables
- standard A/V cables
 - For better picture performance, if your VCR has S-video, connect an S-video cable and standard (analog) audio cables to the **VIDEO-2** inputs on the side panel (instead of the **VIDEO-1** inputs). Do not connect both types of video cable to **VIDEO-2** at the same time or the picture performance will be unacceptable.
 - If you have a mono VCR, connect **L/MONO** on the TV to your VCR's audio out terminal using the white audio cable only.
- standard audio cables
- component video cables
 - You can connect the component video cables (plus audio cables) from the DVD player or satellite receiver to either set of **ColorStream** terminals on the TV (**HD-1** or **HD-2**). The **ColorStream HD-1** and **HD-2** terminals can be used with Progressive (480p, 720p) and Interlaced (480i, 1080i) scan systems. A 1080i signal will provide the best picture performance.
 - If your DVD player or satellite receiver does not have component video, connect a standard A/V cable to **VIDEO-1**. If your DVD player has HDMI video, see page 15.

To view antenna or Cable channels:

Select the **ANT** video input source on the TV.*

To view the DVD player:

Turn ON the DVD player. Select the **ColorStream HD2** video input source on the TV.*

To view satellite programs using the component video connections:

Turn on the satellite receiver. Select the **ColorStream HD1** video input source on the TV.*

To view the VCR or view and record antenna channels:

Turn ON the VCR. Tune the VCR to the channel you want to watch. Select the **Video2** video input source on the TV.*

To record a TV program while watching a DVD:

Turn ON the VCR. Tune the VCR to the channel to record. Select the **ColorStream HD2** video input source on the TV* to view the DVD.

* To select the video input source, press **INPUT** on the remote control (page 30). To program the TV remote control to operate other devices, see Chapter 3.

The unauthorized recording, use, distribution, or revision of television programs, videotapes, DVDs, and other materials is prohibited under the Copyright Laws of the United States and other countries, and may subject you to civil and criminal liability.

Connecting a camcorder

You will need:

- standard A/V cables
 - For better picture performance, if your camcorder has S-video, connect an S-video cable (plus the audio cables) to **VIDEO-2** on the TV right side panel.

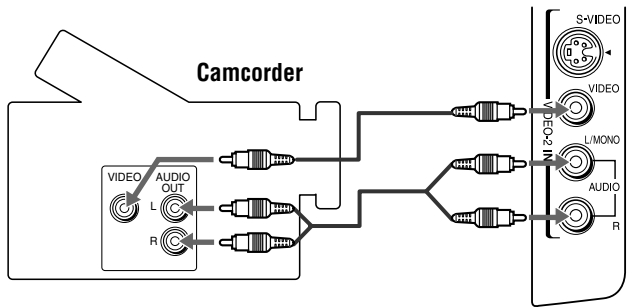

VIDEO-2 inputs on TV right side panel

To view the camcorder video:

Select the **Video2** video input source on the TV.*

* To select the video input source, press **INPUT** on the remote control (see page 30). To program the TV remote control to operate other devices, see Chapter 3.

Connecting an audio system

This connection allows you to use external speakers with an external analog audio amplifier to adjust the sound level.

You will need:

- standard audio cables

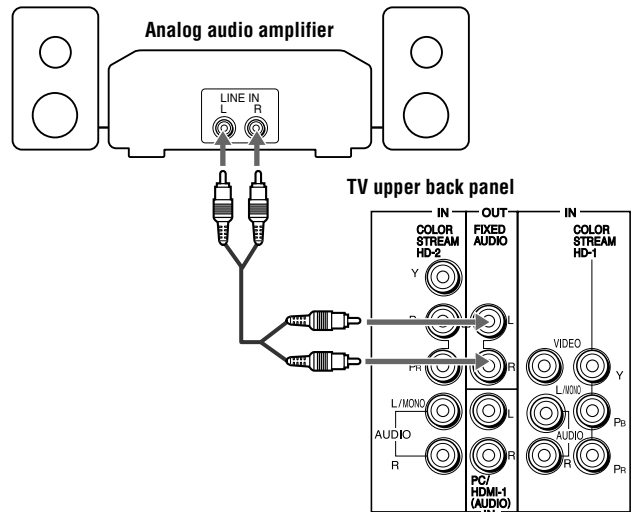

To control the audio:

- 1 Turn on the TV and the stereo amplifier.
- 2 Minimize the sound volume from the TV's built-in speakers and control the volume level using the amplifier's remote control.

Connecting an HDMI™ or DVI device to the HDMI input

The HDMI input on your TV receives digital audio and uncompressed digital video from an HDMI source device, or uncompressed digital video from a DVI (Digital Visual Interface) source device.

This input is designed to accept HDCP (High-Bandwidth Digital-Content Protection) program material in digital form from EIA/CEA-861-861B-compliant^[1] consumer electronic devices (such as a set-top box or DVD player with HDMI or DVI output).

- The following signal formats can be displayed:

Format	Resolution	V. Frequency
VGA	640 × 480	59.94/60Hz
480i (60Hz)	720 × 480	59.94/60Hz
480p (60Hz)	720 × 480	59.94/60Hz
720p (60Hz)	1280 × 720	59.94/60Hz
1080i (60Hz)	1920 × 1080	59.94/60Hz
1080p (24/60Hz)	1920 × 1080	59.94/60Hz

Note: To connect a PC to the HDMI input, see page 16.

To connect an HDMI device, you will need:

- one HDMI cable (type A connector) per HDMI device
 - For proper operation, it is recommended that you use an HDMI cable with the HDMI Logo (**HDMI**). You should use an HDMI cable shorter than 16.4 ft (5m) for 1080p input signals.
 - HDMI cable transfers both video and audio. Separate analog audio cables are not required (see illustration).
 - See “Setting the HDMI™ audio mode” on page 29.

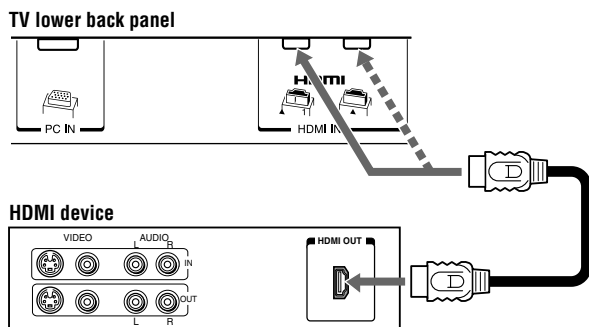

To view the HDMI device video:

Select the HDMI1 or HDMI2 video input source on the TV.*

Note: If the audio output mode of the HDMI device is other than the PCM mode, the TV speakers will not output sound.

* To select the video input source, press **INPUT** on the remote control (page 30). To program the TV remote control to operate other devices, see Chapter 3.

To connect a DVI device, you will need:

- one HDMI-to-DVI adapter cable (HDMI type A connector) per DVI device
 - For proper operation, the length of an HDMI-to-DVI adapter cable should not exceed 9.8 ft (3m). The recommended length is 6.6 ft (2m).
- one pair of standard analog audio cables per DVI device
 - An HDMI-to-DVI adapter cable transfers video only. Separate analog audio cables are required (see illustration).
 - See “Setting the HDMI™ audio mode” on page 29.

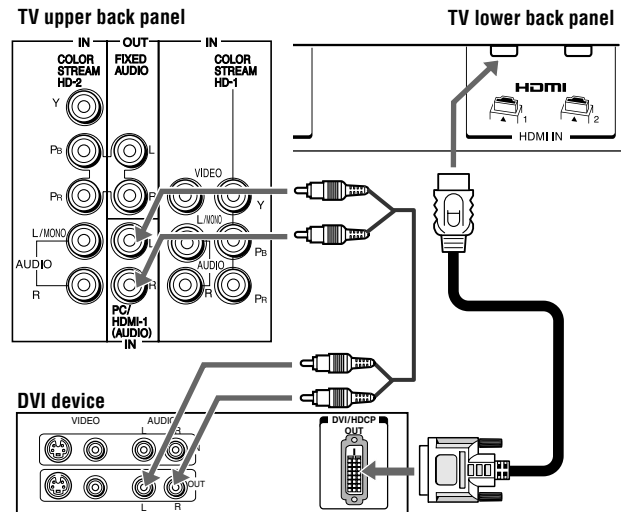

Note: To ensure that the HDMI or DVI device is reset properly, it is recommended that you follow these procedures:

- When turning on your electronic components, **turn on the TV first**, and then the HDMI or DVI device.
- When turning off your electronic components, **turn off the HDMI or DVI device first**, and then the TV.

[1] EIA/CEA-861-861B compliance covers the transmission of uncompressed digital video with high-bandwidth digital content protection, which is being standardized for reception of high-definition video signals. Because this is an evolving technology, it is possible that some devices may not operate properly with the TV.

HDMI, the HDMI logo and High-Definition Multimedia Interface are trademarks or registered trademarks of HDMI Licensing LLC.

Connecting a personal computer (PC)

With either the PC IN or HDMI connection, you can watch your computer's display on the TV and hear the sound from the TV's speakers.

To connect a PC to the PC IN terminal on the TV:

When connecting a PC to the PC IN terminal on the TV, use an analog RGB (15-pin) computer cable and a PC audio cable.

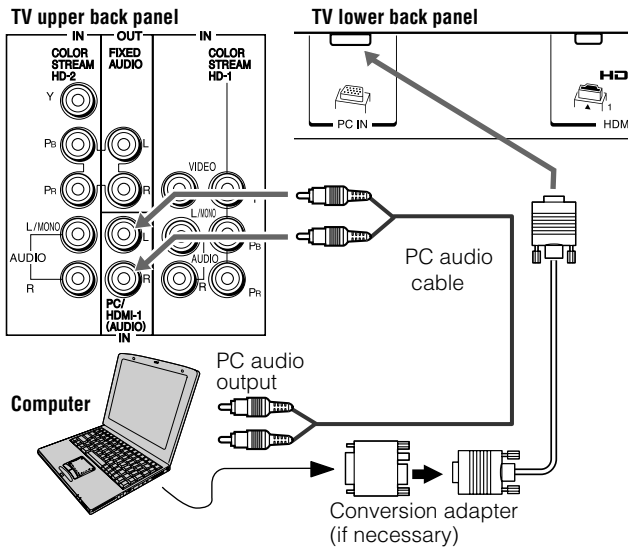

- To use a PC, set the monitor output resolution on the PC before connecting it to the TV. The following signals can be displayed:

Format	Resolution	V. Frequency
VGA	640 × 480	60Hz/75Hz
SVGA	800 × 600	60Hz/75Hz
XGA	1024 × 768	60Hz/70Hz/75Hz
WXGA	1280 × 768	60Hz/75Hz
WXGA	1360 × 768	60Hz
SXGA	1280 × 1024	60Hz/75Hz

Other formats or non-standard signals will not be displayed correctly.

- To display the optimum picture, use the PC setting feature (☞ “Using the PC settings feature” on page 42).

Note:

- The PC audio input terminals on the TV are shared with the HDMI-1 analog audio input terminals (☞ page 42).
- Some PC models cannot be connected to this TV.
- An adapter is not needed for computers with a compatible mini D-sub 15-pin terminal.

- Depending on the DVD's title and the specifications of the PC on which you are playing the DVD-Video, some scenes may be skipped or you may not be able to pause during multi-angle scenes.
- These signal formats are converted to match the number of pixels of the LCD panel. Therefore, the TV may not display small text properly.
- If you connect this TV to your PC, the compressed image is displayed in SXGA mode, therefore the picture quality may deteriorate and characters may not be read.
- A bar may appear in the upper, lower, right or left side of the screen, or parts of the picture may be obscured depending on some signals. This is not the malfunction.

To connect a PC to the HDMI terminal on the TV:

When connecting a PC to the HDMI terminal on the TV, use an HDMI-to-DVI adapter cable and analog audio cables.

If connecting a PC with an HDMI terminal, use an HDMI cable (type A connector). Separate analog cables are not necessary (☞ page 15).

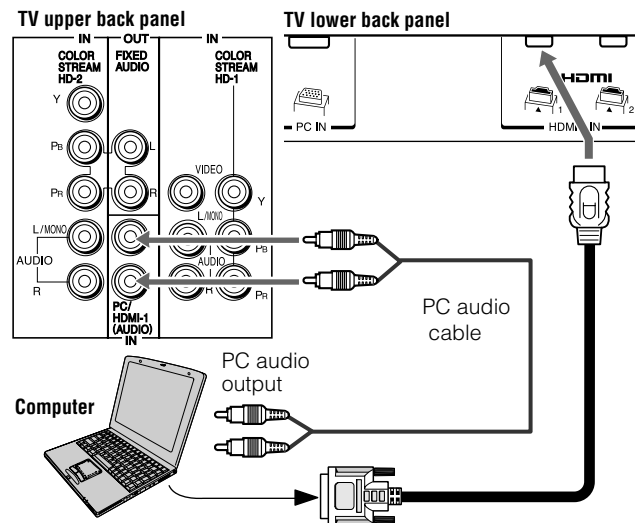

- The following signal formats can be displayed:

Format	Resolution	V. Frequency
VGA	640 × 480	59.94/60Hz
480i (60Hz)	720 × 480	59.94/60Hz
480p (60Hz)	720 × 480	59.94/60Hz
720p (60Hz)	1280 × 720	59.94/60Hz
1080i (60Hz)	1920 × 1080	59.94/60Hz
1080p (24/60Hz)	1920 × 1080	59.94/60Hz

Note:

- The edges of the images may be hidden.
- If receiving a 720p, 1080i, or 1080p signal program, Native mode scales the video to display the entire picture within the borders of the screen (i.e. no overscanning).

Chapter 3: Using the remote control

Preparing the remote control for use

Your TV remote control can operate your TV and many other devices such as cable converter boxes, satellite receivers, VCRs, DVD players, and HTIBs (home theater in a box), even if they are different brands.

If you have a Toshiba device:

Your TV remote control is preprogrammed to operate most Toshiba devices (see page 21).

If you have a non-Toshiba device or a Toshiba device that the remote control is not preprogrammed to operate:

You can program the TV remote control so it will operate the other device (see pages 19–23).

Installing the remote control batteries

- 1 Remove the battery cover from the back of the remote control.

Squeeze tab and lift cover.

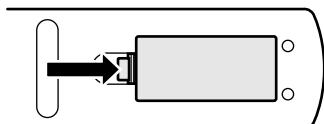

- 2 Install two “AAA” size batteries, making sure to match the + and – signs on the batteries to the signs on the battery compartment.

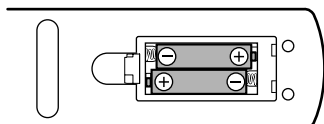

- 3 Reinsert the battery cover in the remote control until the tab snaps.

Caution: Never throw batteries into a fire.

Note:

- Be sure to use AAA size batteries.
- Dispose of batteries in a designated disposal area.
- Batteries should always be disposed of with the environment in mind. Always dispose of batteries in accordance with applicable laws and regulations.
- If the remote control does not operate correctly, or if the operating range becomes reduced, replace batteries with new ones.
- When necessary to replace batteries in the remote control, always replace both batteries with new ones. Never mix battery types or use new and used batteries in combination.

- Always remove batteries from the remote control if they are dead or if the remote control is not to be used for an extended period of time. This will prevent battery acid from leaking into the battery compartment.

Remote control effective range

For optimum performance, aim the remote control directly at the TV and make sure there is no obstruction between the remote control and the TV.

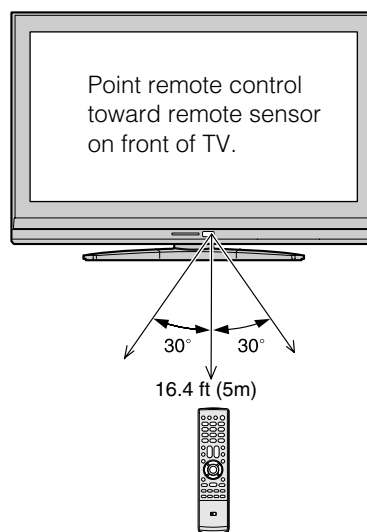

Learning about the remote control

The buttons used for operating the TV only are described here. For a complete list of the remote control's functions, see the remote control functional key chart (☞ page 20).

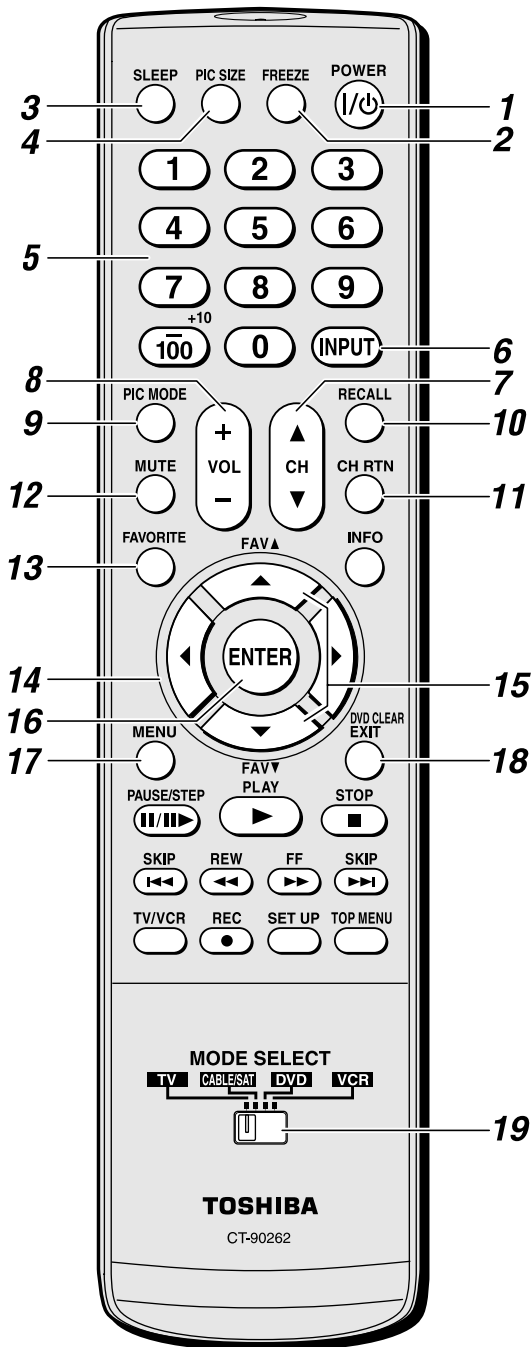

- 1 **POWER** turns the TV on and off. Press **POWER** to turn on the TV. The green LED indicator on the TV front will be illuminated. Press **POWER** again to turn off the TV.
- 2 **FREEZE** freezes the picture. Press again to restore the moving picture.
- 3 **SLEEP** accesses the sleep timer (☞ page 43).
- 4 **PIC SIZE** selects the pictures sizes: **Natural**, **TheaterWide 1/2/3**, **Full**, **4:3 HD**, and **Native** (☞ page 31).
- 5 **Channel Numbers (0–9, –/100)** directly tune channels.
- 6 **INPUT** selects the video input source (☞ page 30).
- 7 **CH ▲▼** cycles through programmed channels when no menu is on-screen (☞ page 26).
- 8 **VOL + –** adjusts the volume level.
- 9 **PIC MODE** selects the picture mode (page 35).
- 10 **RECALL** displays TV setting information on-screen (☞ page 44).
- 11 **CH RTN** returns to the last viewed channel or source (☞ page 31).
- 12 **MUTE** reduces or turns off the sound (☞ page 38).
- 13 No Function (This button is not available for this TV.)
- 14 **Arrow buttons (▲▼◀▶)** When a menu is on-screen, these buttons select or adjust programming menus.
- 15 **FAV ▲▼** tunes to the next higher/lower favorite channel (☞ page 28).
- 16 **ENTER** activates highlighted items in the main menu system.
- 17 **MENU** accesses the main TV menu system (☞ pages 24 and 25).
- 18 **EXIT** closes on-screen menus.
- 19 **MODE SELECT Switch** switches between TV, CABLE/SAT, DVD, and VCR modes (☞ page 19). Set to “TV” to control the TV.

Note: The error message “Not Available” may appear if you press a key for a function that is not available.

Using the remote control to operate your other devices

If you have a non-Toshiba device or a Toshiba device that the remote control is not preprogrammed to operate, you must first program the remote control to recognize the device (if you have not already done so) (pages 21–23).

To use your TV remote control to operate a:

- Cable converter box or satellite receiver, set the MODE SELECT Switch to **CABLE/SAT**.
- DVD player or HTIB, set the MODE SELECT Switch to **DVD**.
- VCR, set the MODE SELECT Switch to **VCR**.

Note: Even after the TV remote control is programmed, it may not operate certain features on your other device. If this happens and you wish to use those features, you will need to use the device's original remote control.

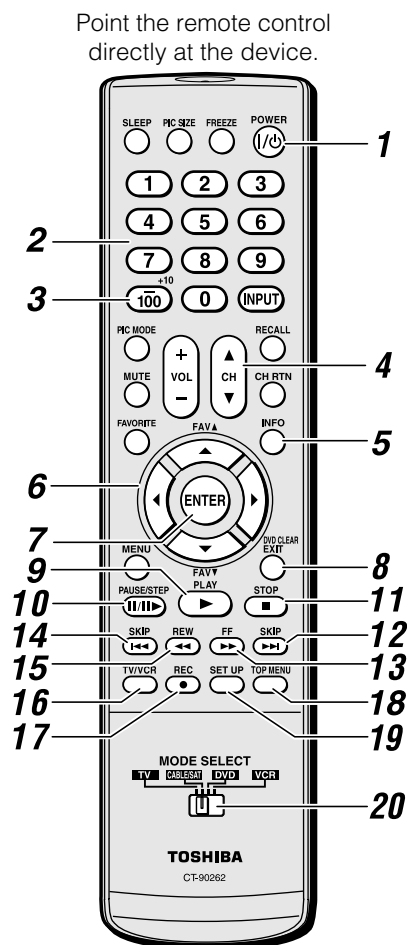

- 1 POWER** Turns the selected device on and off.
- 2 Channel Numbers (0-9)** Press to directly access channels (as opposed to \uparrow CH \downarrow).
- 3 +10** Press to directly access DVD chapters higher than 10.
- 4 CH \uparrow \downarrow**
 \uparrow selects the next higher channel;
 \downarrow selects the next lower channel (for channels programmed into memory only).
- 5 INFO** Displays TV status information on-screen.
- 6 \uparrow \downarrow \leftarrow \rightarrow** Press to navigate DVD menus (may not work on some DVD players).
- 7 ENTER** Required by some satellite receivers and DVD players.
- 8 DVD CLEAR** Press to reset the title and chapter number.
- 9 PLAY** Begins playback of a tape or DVD.
- 10 PAUSE** Press during play or record mode to pause the picture; press again to restart.
- 11 STOP** Stops the tape or DVD.
- 12 SKIP \rightarrow** Skips forward to locate later DVD chapters.
- 13 FF** Fast-forwards the tape or DVD. (Press during play mode to view the picture moving rapidly forward.)
- 14 SKIP \leftarrow** Skips back to beginning of current DVD chapter or locates previous chapters.
- 15 REW** Rewinds/reverses the tape or DVD. (Press during play mode to view the picture moving rapidly backward.)
- 16 TV/VCR** To view one program while recording another, press to select TV mode.
- 17 REC** Starts tape recording.
- 18 TOP MENU** Accesses a DVD's top menu.
- 19 SET UP** Accesses a DVD's setup menu.
- 20 MODE SELECT Switch** Set to "TV" to control the TV; "CABLE/SAT" to control a cable converter box or satellite receiver; "DVD" to control a DVD player or HTIB; "VCR" to control a VCR.

Remote Control functional key chart

Note:

- “---” = key does not send a signal in that remote control mode.
- ← TV = key will affect the TV, even when the remote control is not in the “TV” device mode.

REMOTE CONTROL KEY	DEVICE MODE				
	TV	CABLE	SAT	VCR	DVD
POWER	Power	Power	Power	Power	Power
SLEEP	Sleep timer	← TV	← TV	← TV	← TV
INPUT	TV/Video select	← TV	← TV	← TV	← TV
1-9	Digit 1-9	Digit 1-9	Digit 1-9	Digit 1-9	Digit 1-9
0	Digit 0	Digit 0	Digit 0	Digit 0	Digit 0
100/-/+10	-/100	---	– (sub CH)	100	+10
RECALL	RECALL	← TV	← TV	Display	← TV
CH RTN	Previous channel	---	---	---	---
INFO	---	---	Info	---	---
MENU	Menu/DVD Menu	---	Menu	---	DVD Menu
▲▼/FAV▲▼	Menu select/ FAV up/down	---	Menu up/down	---	Menu up/down
◀	Menu select	---	Menu left	---	Menu left
▶	Menu select	---	Menu right	---	Menu right
ENTER	Enter	---	Select Enter	---	Enter
EXIT/DVD CLEAR	Exit	---	Exit	---	DVD Clear
VOL + -	Volume up/down	← TV	← TV	← TV	← TV
CH▲▼	Channel up/down	Channel up/down	Channel up/down	Channel up/down	---
PIC SIZE	Picture size	← TV	← TV	← TV	← TV
MUTE	Sound mute	← TV	← TV	← TV	← TV
FF	---	---	---	Fast FWD	Fast FWD
PAUSE/STEP	---	---	---	Pause	Pause
PLAY	---	---	---	Play	Play
REW	---	---	---	Rewind	Rewind (reverse)
PIC MODE	PIC MODE	← TV	← TV	← TV	← TV
STOP	---	---	---	Stop	Stop
FREEZE	Freeze picture	← TV	← TV	← TV	← TV
SKIP ◀◀	---	---	---	---	Skip REV
SKIP ▶▶	---	---	---	---	Skip FWD
TV/VCR	---	---	---	TV/VCR	---
REC	---	---	---	Record (2 click)	---
SET UP	---	---	---	---	DVD Setup
TOP MENU	---	---	---	---	Top Menu

Programming the remote control to operate your other devices

Your Toshiba TV remote control is preprogrammed to operate most Toshiba devices. To program your TV remote control to operate a non-Toshiba device (or a Toshiba device that it is not preprogrammed to operate), follow the steps below. For details on using the remote control to operate the device, see page 19.

- 1** In the remote control code table (page 22), find the code for your device. If more than one code is listed, try each one separately until you find one that works.
- 2** Set the MODE SELECT Switch to the type of device you are programming the remote control to operate — CABLE/SAT (for a cable converter box or satellite receiver), DVD (for a DVD player or HTIB [home theater in a box]), or VCR (for a VCR or TV/VCR combo).
- 3** While holding down **RECALL**, press the Channel Number buttons to enter the 3-digit code for your device.
- 4** To test the code, turn on the device, point the remote control at it, and press **POWER**. (Also see notes below.)
 - If the correct code was entered, the device will turn off.
 - If the device does not respond, repeat steps 1–4 using another code.
 - If the device does not respond to another code, you will need to use the device's original remote control.
- 5** Remember to set the MODE SELECT Switch back to "TV" to control the TV.
- 6** For future reference, write down the code(s) you used:

DEVICE	CODE	DEVICE	CODE

Note:

- In addition to **POWER**, confirm that all necessary keys on the TV remote control operate your device. If some keys are not operational, repeat the device code setup using another code (if other codes are listed for your device). If, after trying all listed codes, the necessary keys do not operate your device, use the device's original remote control.
- Every time you change the batteries, you will need to reprogram the remote control.
- Some newer VCRs respond to either of two codes. These VCRs have a switch labeled "VCR1/VCR2." If your VCR has this kind of switch and does not respond to the codes for your VCR brand, set the switch to the other position ("VCR1" or "VCR2") and reprogram the remote control.

Remote control codes

In some cases you may not be able to operate your device with the TV remote control. Your other device may use a code that is not recognized by the TV remote control. If this happens, use the device's remote control.

Cable converter box

ABC	061, 062, 063, 082, 084, 087, 091, 092, 096, 098
Archer	065, 092, 097, 099
Cableview	064, 094
Century	092
Citizen	090, 092, 097
Contec	083, 085, 086, 088, 093, 098
Diamond	093
Eagle	091
GE	061, 062
Gemini	069, 070, 094
Hamlin	093
Hitachi	062, 095, 096
Jasco	097
Magnavox	072, 096
Memorex	091, 092, 104
Motorola/GI/Jerrold	062, 069, 071, 082, 086, 089, 091, 096
Multi Canal	090
Novavision	101
Panasonic	081, 083, 085
Philco	087
Philips	066, 067, 068, 070, 072, 073, 074, 075, 091, 092
Pioneer	076, 077
Proscan	061, 062
Radio Shack	092, 097, 099
RCA	064, 081
Realistic	065
Recoton	102
Samsung	077, 090
Scientific Atlanta	063, 078, 079, 080, 088, 098, 101, 105
Sears	095
Signature	062
Signature 2000	096
Sprucer	081, 085
Starcom	069, 082, 087, 096, 103, 104
Stargate	069, 090
Sylvania	095, 100
TeleView	090
Texscan	100
Tocom	071, 084, 085
U. S. Electronics	087, 096, 098
United Cable	082
Universal	065, 092, 097, 099, 102, 103
Wards	096

Satellite receiver

Alphastar	038, 059
Chaparral	034
DISH Network	057

Drake	020, 040, 044, 046, 050, 053
Echostar	018, 041, 051
Express Vu	057
Fujitsu	027
GE	008, 009, 013
General Instruments	010, 011, 012, 022, 023, 031, 049
Hitachi	033
Hughes	033
Hughes Network Systems	019
Intersat	048
Janeil	027
JVC	017, 057
Kenwood	029
Magnavox	060
Optimus	058
Pansat	036, 052
Primestar	015, 042
Proscan	008, 009, 013
Radio Shack	022, 023, 030
RCA	008, 009, 013, 016
Realistic	030
Samsung	059
Sony	014, 055
Star Choice	057
Star Trak	025, 026, 037, 054
STS	024
Toshiba	000, 001, 002, 003, 004, 005, 006, 007, 020, 031, 056
Uniden	021, 028, 030, 032, 035, 039, 043, 045, 047, 058
Zenith	027

TV/VCR Combo

Action	078
GE	059, 062
Goldstar	065
Panasonic	065
Precision	078
Quasar	065
Realistic	079
Sony	074
Toshiba	057
Totevision	009, 010, 065
Zenith	065

DVD/VCR Combo

Go Video	DVD=087, VCR=081
JVC	DVD=088, VCR=082
RCA	DVD=089, VCR=083
Samsung	DVD=090, VCR=084
Sanyo	DVD=091, VCR=085
Zenith	DVD=092, VCR=086

DVD player

Aiwa	006, 015
Apex	016, 017
BOSE	097
Broksonic	018
Clarion	019

Classic	020
Daewoo	021
Denon	022, 023, 024, 025
Emerson	026, 027
Fisher	028
Funai	027
GE	001, 029, 030
Go Video	087
GPX	031
Hitachi	005, 032, 033, 034, 035
JVC	003, 007, 036, 042, 088
Kenwood	037
Konka	008, 009
Magnavox	004, 038
Memorex	039
Mintek	040
NAD	026
Nakamichi	041
Norcent	043
Onkyo	044
Oritron	058
Panasonic	010, 045, 046, 047, 048, 049, 050
Philips	004, 051
Pioneer	052, 053, 054, 055
Proscan	001, 056
Qwestar	057, 058
RCA	001, 002, 059, 089
Sampo	060
Samsung	061, 062, 086, 090
Sansui	073
Sanyo	063, 091
Sharp	064, 067
Sherwood	074
Sony	011, 012, 065, 066, 068, 069, 070
Sylvania	027
Teac	071
Technics	072
Techwood	075
Toshiba	000, 013, 076, 077, 078
Yamaha	079, 080, 081
Zenith	014, 082, 092

Portable DVD player

Aiwa	093
Audiovox	094, 095
Panasonic	024, 096, 099
RCA	098

VCR

Admiral	049
Aiko	019
Aiwa	018
Akai	003, 004, 037, 038, 039, 058, 069
Audiovox	010
Bell & Howell	007, 068
Broksonic	008, 017
Calix	010
Carver	026
CCE	019
Citizen	009, 010, 011, 012, 013, 014, 015, 019, 057, 073
Colortyme	005
Craig	009, 010, 016, 061, 065, 079

Chapter 3: Using the remote control

Curtis Mathes	001, 005, 009, 012, 014, 040, 048, 053, 056, 057	Panasonic	036, 045, 046, 057, 061, 072, 079	Wards	009, 010, 011, 016, 018, 020, 024, 025, 031, 035, 049, 051, 056, 057, 060, 065, 066, 079
Daewoo	011, 013, 015, 017, 018, 019, 057, 078	Pentax	012, 024, 025, 035, 042, 053, 063	White Westinghouse	073
Daytron	078	Pentex Research	014	XR-1000	018
Denon	063	Philco	026, 027, 063	Yamaha	005, 006, 007, 014, 037, 053
Dimensia	001, 048	Philips	026, 031, 044, 057	Zenith	004, 032, 034, 041, 047, 069, 086
Electrohome	010, 020, 065	Pioneer	006, 024, 043, 055		
Emerson	003, 008, 010, 011, 017, 018, 020, 028, 039, 054, 057, 062, 065, 068, 072	Portland	012, 013, 015		
Fisher	007, 016, 021, 022, 023, 057, 064, 068, 070, 071, 079	Proscan	001, 002, 048		
Fuji	004, 041	Proton	061		
Funai	018, 073	Quasar	045		
Garrard	018	Radio Shack	010, 031, 065		
GE	001, 002, 009, 040, 042, 048, 056	Radio Shack/Realistic	007, 009, 010, 016, 018, 020, 021, 022, 031, 049		
Go Video	056, 059, 061, 081	Radix	010		
Goldstar	005, 010, 014, 054, 056, 065, 067	RCA	001, 002, 003, 009, 024, 025, 029, 035, 040, 042, 045, 048, 055, 056, 063, 071, 083		
Gradiente	018, 065	Realistic	007, 009, 010, 011, 016, 018, 020, 021, 022, 031, 049, 051, 056, 060, 065, 075, 079		
Harman Kardon	005	Ricoh	047		
Hitachi	024, 025, 035, 037, 042, 063, 070, 080	Runco	034		
JBL	076	Samsung	009, 011, 038, 056, 073, 084		
JC Penney	005, 006, 007, 008, 009, 010, 023, 024, 025, 026, 035, 056, 061, 063, 065	Sansui	006, 037, 043, 061		
Jensen	024, 025, 037	Sanyo	007, 009, 016, 054, 064, 068, 071, 075, 079, 085		
JVC	005, 006, 007, 014, 037, 043, 062, 063, 068, 082	Scott	008, 011, 017, 028, 030, 057, 065, 072		
Kenwood	005, 006, 007, 012, 014, 037, 043, 053, 068, 071	Sears	007, 010, 016, 021, 022, 023, 024, 025, 035, 053, 057, 063, 064, 065, 068, 071, 075, 079		
Kodak	010	Sharp	013, 020, 031, 049, 051, 060, 066		
LG	010	Shintom	004, 025, 032, 061		
Lloyds	053, 073, 079	Signature	049		
Logik	061	Signature 2000	075		
LXI	010	Singer	047, 061		
Magnasonic	061, 065, 078	Sony	004, 032, 033, 041, 052, 058, 070, 074, 076, 077, 080		
Magnavox	026, 027, 034, 044, 057, 061, 072	STS	035		
Marantz	005, 006, 007, 012, 014, 026, 053, 067	Sylvania	018, 026, 027, 028, 044, 072		
Memorex	007, 009, 010, 016, 018, 034, 049, 063, 065, 066, 068, 075, 079	Symphonic	018, 051, 053, 073, 079		
MGA	020, 028, 039	Tandy	007		
MGN	056	Tashiko	010		
Minolta	024, 025, 035, 063	Tatung	037		
Mitsubishi	020, 024, 025, 028, 039, 043, 065	Teac	018, 029, 037		
Montgomery Ward	049	Technics	036		
Motorola	049	Teknika	010, 018, 065		
MTC	009, 046, 061	Toshiba	000, 011, 021, 023, 024, 028, 030, 039, 057, 074, 078, 079		
Multitech	009, 012, 018	Totevision	009, 010, 065		
NEC	005, 006, 007, 012, 014, 037, 043, 053, 054, 067, 070	Unitec	073		
Nikko	010	Unitech	009		
Noblex	009	Vector Research	005, 006, 011, 012, 053		
Optimus	010, 049, 065	Video Concepts	005, 006, 011, 012, 039, 053		
Optonica	031				
Orion	054, 057, 062, 065, 068, 072				

HTIB





Lasonic	083
Panasonic	084
Venturer	085

Chapter 4: Menu layout and navigation

Menu Layout

The illustrations below provide a quick overview of your TV's menu system.

To open the main menus (illustrated below), press  on the remote control or TV control panel.

Icon	Item	Option
	Mode	→ Sports/Standard/Movie/Preference
	Picture Settings	→ [Picture Settings edit window]
	Cinema Mode	→ Film/Video
	MTS	→ Stereo/SAP/Mono
	Bass	→ [Adjust the bass audio quality]
	Treble	→ [Adjust the treble audio quality]
	Balance	→ [Adjust the balance audio quality]
	WOW	→ SRS 3D/FOCUS/TruBass
	StableSound	→ On/Off
	Language	→ English / Français / Español
	TV/CABLE	→ [Select the input source (TV/Cable)]
	CH Program	→ [Start channel programming automatically]
	Add/Erase	→ [Add/Erase a channel]
	Channel Labeling	→ [Channel Labeling edit window]
	Video Label	→ [Video input labeling edit window]
	AV Connection	→ [PC/HDMI Audio Settings edit window]
	Picture Position	→ [Picture Position Settings edit window]
	PC Settings	→ [PC Settings edit window]
	Sleep Timer	→ [Sleep Timer edit window]
	On Timer	→ [On Timer edit window]
	CC	→ Off/C1/C2/C3/C4/T1/T2/T3/T4
	CC Reception Adjustment	→ Mode 1/Mode 2
	Favorite Channel	→ [Favorite Channels edit window]
	Auto Aspect	→ On/Off
	Blue Screen	→ On/Off
	Side Panel	→ 1/2/3
	Locks	→ Channel Lock/Video Lock/New PIN Code

Navigating the menu system

You can use the buttons on the remote control or TV control panel to access and navigate your TV's on-screen menu system.

- Press **MENU** to open the menu system.
- When a menu is open, use the up/down/left/right arrow buttons (**▲▼◀▶**) on the remote control or TV control panel to move in the corresponding direction in the menu.
- Press **ENTER** to save your menu settings or to select a highlighted item. (A highlighted menu item appears in a different color in the menu.)
- All menus close automatically if you do not make a selection within 60 seconds.
- To close a menu instantly, press **EXIT**.

Selecting the menu language

You can choose from three different languages (English, French and Spanish) for the on-screen display of menus and messages.

To select the menu language:

- 1 Press **MENU** and open the **Set Up** menu.
- 2 Press **▲** or **▼** to highlight **Language**.

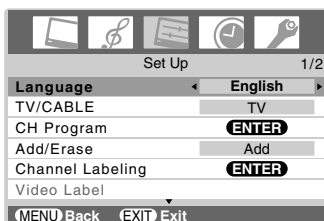

- 3 Press **◀** or **▶** to display your desired language.
- 4 Press **EXIT** to close the **Set Up** menu.

Programming channels into the TV's channel memory

When you press **(CH)** or **(CH)** on the remote control or TV control panel, your TV will stop only on the channels you program into the TV's channel memory.

Follow the steps below to program channels into the TV's channel memory.

Programming channels automatically

Your TV can automatically detect all active channels in your area and store them in its memory. After the channels are programmed automatically, you can manually add or erase individual channels in the channel memory.

Note:

- If the input signal type is set to **CABLE** for an antenna input, the automatic channel programming process erases channels that were previously programmed into the TV's memory.
- If the input signal type is set to **TV**, the automatic channel programming process does NOT erase channels that were previously programmed into the TV's memory, but adds newly found channels to the existing set of programmed channels. To remove a channel from the memory, you must manually delete it.
- To tune the TV to a channel not programmed in the channel memory, you must use the Channel Number buttons on the remote control.
- Programming channels for an antenna input configured for **CABLE** will take substantially longer than for an antenna input configured for **TV**. This is normal; however, once channel programming is completed, you should not have to repeat the programming process again unless your Cable TV service lineup changes significantly.

To program channels automatically:

- 1 Press **MENU** and open the **Set Up** menu.
- 2 Press **▲** or **▼** to highlight **TV/CABLE**.
- 3 Press **◀** or **▶** to select either **TV** (if you use an antenna) or **CABLE** (if you use cable channels).

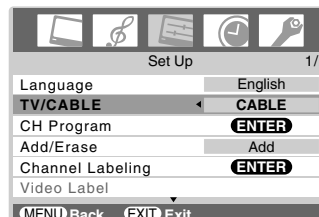

- 4 Press **▼** to select **CH Program**.

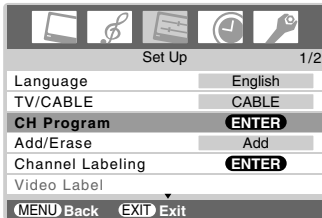

- 5 Press **ENTER** to start channel programming. The TV will automatically cycle through every channel (**TV** or **CABLE**, depending on which you selected in step 3), and store all active channels in the channel memory. While the TV is cycling through the channels, the message “Programming Now—Please Wait” appears.
- 6 When channel programming is complete, the message “Completed” appears.
- 7 Press **CH** or **CH** to view the programmed channels.

Manually adding and deleting channels in the channel memory

After automatically programming channels into the channel memory, you can manually add or delete individual channels.

To add or delete channels in the channel memory:

- 1 Select the channel you want to add or erase. If you are adding a channel, you must select the channel using the Channel Number buttons.
- 2 Press **MENU** and open the **Set Up** menu.
- 3 Press **▲** or **▼** to highlight **Add/Erase**.



- 4 Press **◀** or **▶** to select **Add** or **Erase**, depending on the function you want to perform.
- 5 Repeat steps 1–4 for other channels you want to add or erase.

Programming your favorite channels

You can preset up to 12 of your favorite channels using the Favorite Channel Programming feature. Because this feature scans through only your favorite channels, it allows you to skip other channels you do not normally watch.

To add and delete channels in the Favorite Channel lists:

- 1 Press **MENU** and open the **Function** menu.
- 2 Press **▲** or **▼** to highlight **Favorite Channel**.

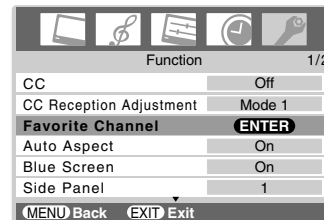

- 3 Press **ENTER** to display the **Favorite Channel** menu. **Channel Input** will be highlighted.
- 4 Press the Channel Number buttons to enter one of your favorite channels.

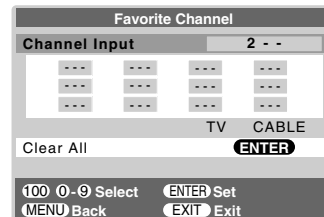

- 5 Press **ENTER**.
- 6 Repeat steps 4 and 5 for your other favorite channels.

To clear a favorite channel:

- 1 Press **MENU** and open the **Function** menu.
- 2 Highlight **Favorite Channel** and press **ENTER**.
- 3 Press **▲▼◀▶** to highlight the channel you want to clear, then press **ENTER**.

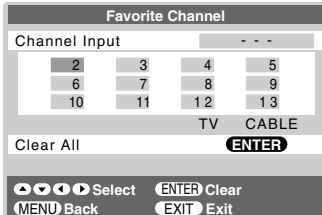

- 4 Repeat step 3 for other favorite channels you want to clear.

To clear all favorite channels at once:

Press **▲** or **▼** to highlight **Clear All** in step 3 above, and then press **ENTER** to clear all favorite channels at once.

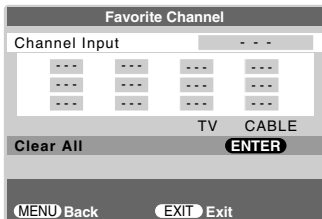

To tune your favorite channels for the current ANT input:

Press **FAV▲ / FAV▼**.

Labeling channels

Channel labels appear briefly on-screen above the channel number display each time you turn on the TV, change a channel, or press **RECALL**. You can choose any seven characters to identify a channel.

To create channel labels:

- 1 Press **MENU** and open the **Set Up** menu.
- 2 Highlight **Channel Labeling** and press **ENTER**.

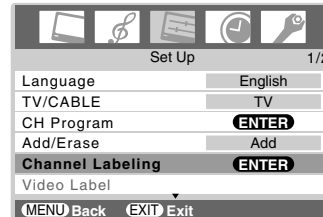

- 3 Press **▲** or **▼** or the Channel Numbers to select a channel you want to label.

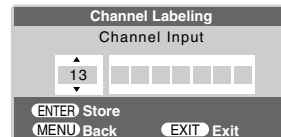

- 4 Press **▶** to select a character for the first space, and then repeatedly press **▲** or **▼** to select a character.



- 5 Repeat step 4 to enter the rest of the characters. If you would like a blank space in the label name, you must choose an empty space from the list of characters; otherwise, a dash (–) will appear in that space.
- 6 Repeat steps 3–5 to label other channels.
- 7 Press **ENTER** to store your settings.

To erase channel labels:

Select blanks in steps 4 and 5 above.

Setting the HDMI™ audio mode

To set the HDMI audio mode:

- 1 Press **MENU** and open the **Set Up** menu.
- 2 Highlight **AV Connection** and press **ENTER**.
- 3 Press **▲** or **▼** to select **HDMI1 Audio**, and then press **◀** or **▶** to select the HDMI audio mode (**Auto**, **Digital**, or **Analog**). (**Auto** is the recommended mode). See “Connecting an HDMI or DVI device to the HDMI input” (page 15).

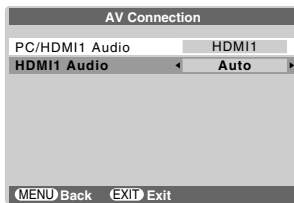

Note: Because the **PC** and **HDMI1** inputs share the same set of analog audio inputs, the **PC/HDMI1 Audio** setting influences the **HDMI1 Audio** setting. If **PC/HDMI1 Audio** is set to **HDMI1**, the **HDMI1 Audio** setting changes to **Auto**. If **PC/HDMI1 Audio** is set to **PC**, the **HDMI1 Audio** setting is set to **Digital** and will be grayed out.

When the sound is not audible:

If no sound comes out while receiving HDMI signal, the sound may be audible when using the Lip Sync Latency feature set to off.

- 1 Press **MENU** and open the **Set Up** menu.
- 2 Highlight **AV Connection** and press **ENTER**.
- 3 Press **▲** or **▼** to highlight **HDMI1 Audio**.
- 4 Press and hold **ENTER** for 5 seconds until the **Lip Sync Latency** menu appears on the screen.



- 5 Press **◀** or **▶** to select **Off**.
- 6 Press **POWER** to turn the TV off and on again.

Note: Depending on the connected HDMI device, the sound may be audible by turning it off and on again.

Selecting the video input source to view

Press **INPUT** on the remote control or **INPUT** on the TV control panel to view a signal from another device connected to your TV, such as a VCR or DVD player. You can select Video1/ColorStream HD1, Video2, ColorStream HD2, HDMI1, HDMI2, PC or ANT, depending on which input jacks you used to connect your devices (see Chapter 2).

To select the video input source using the program list:

- 1 Press **INPUT** or **INPUT** to display the program list.

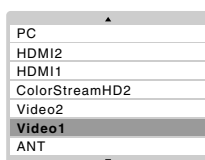

- 2 To scroll through the program list, repeatedly press **INPUT**, **INPUT**, **▲** or **▼** while the program list is on-screen.
- 3 When the desired video input mode is highlighted, press **ENTER**.

Labeling the video input sources

The video label feature allows you to label each input source for your TV from the following preset list of labels:

- --- : Uses the default label name
- VCR : Video cassette recorder
- DVD : DVD video
- DTV : Digital TV set-top box
- SAT : Satellite box
- CBL : Cable box

To label the video input sources:

- 1 Press **INPUT** to select the video source you want to label.
- 2 Press **MENU** and open the **Set Up** menu.
- 3 Press **▲** or **▼** to highlight **Video Label**.

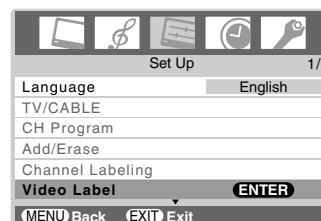

- 4 Press **ENTER** to display the **Video Label** menu.



- 5 Press **▶** to highlight the first space.
- 6 Press **▲** or **▼** to select the desired character for that space.
- 7 Repeat steps 5 and 6 to enter the rest of the characters.
- 8 Finish labeling the other video input sources as desired.
- 9 Press **ENTER** to store your settings.
- 10 To return to the previous menu, press **MENU**.
- 11 To exit the menu, press **EXIT**.

Tuning channels

Tuning your favorite channels

To tune to the channels you programmed as Favorite Channels, see page 27.

Tuning to the next programmed channel

To tune to the next programmed channel:

Press or on the remote control or TV control panel.

Note: This feature will not work unless you program channels into the TV's channel memory (see page 26).

Tuning to a specific channel (programmed or unprogrammed)

Press the Channel Number buttons (0–9, 100) on the remote control. For example, to select channel 125, press 100, 2, 5.

Tuning to a specific programmed channel (or video mode) using the Program list

Press to display the Program list, and then press or to scroll through the Program list. When the desired channel number (or video mode) is highlighted, press .

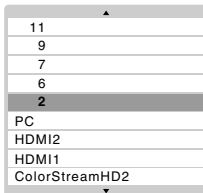

Switching between two channels using Channel Return

The Channel Return feature allows you to switch between two channels without entering an actual channel number each time.

- 1 Select the first channel you want to view.
- 2 Select a second channel using the Channel Number buttons (0–9, 100).
- 3 Press on the remote control. The previous channel will display. Each time you press , the TV will switch back and forth between the last two channels that were tuned.

Note: If you press from a non-antenna input, the TV will return to the last-viewed channel or video input mode.

Selecting the picture size

You can view 480i, 480p, 720p, 1080i, and 1080p format programs in a variety of picture sizes—Natural, TheaterWide 1, TheaterWide 2, TheaterWide 3, Full, 4:3 HD, and Native.

Note: The “picture size” illustrations are examples only. The format of the image (in any of the picture sizes) will vary depending on the format of the signal you are currently watching.

Select the picture size that displays the current program the way that looks best to you.

Picture size Signal	Natural	Theater Wide 1	Theater Wide 2	Theater Wide 3	Full	4:3 HD	Native
480i	yes	yes	yes	yes	yes	no	no
480p	yes	yes	yes	yes	yes	no	no
720p/1080i	(Full)	yes	yes	yes	no	yes	no
720p/1080i/ 1080p (HDMI)	(Full)	yes	yes	yes	no	yes	yes

To select the picture size:

Repeatedly press on the remote control to highlight the desired picture size, as described below and on the next page.

480i/480p receiving

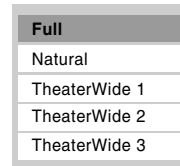

720p/1080i/1080p (HDMI) receiving

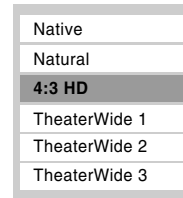

Using these functions to change the picture size (i.e., changing the height/ width ratio) for any purpose other than your private viewing may be prohibited under the Copyright Law and may subject you to civil and criminal liability.

Natural picture size

- The image is displayed close to its originally formatted proportion. Some program formats will display with sidebars and/or bars at the top and bottom.

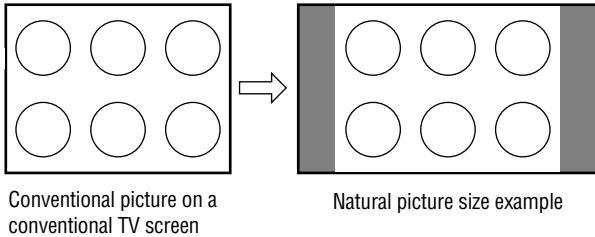

TheaterWide 1 picture size

- The center of the picture remains close to its original proportion, but the left and right edges are stretched wider to fill the screen.
- A small part of the picture at the top and bottom is hidden.

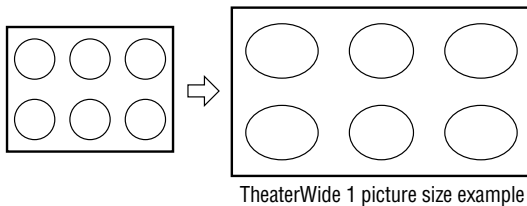

TheaterWide 2 picture size (for letter box programs)

- The picture is stretched wider to fill the width of the screen, but only slightly stretched taller.
- The top and bottom edges of the picture are hidden.

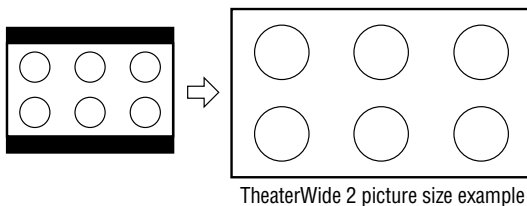

TheaterWide 3 picture size (for letter box programs with subtitles)

- The picture is stretched wider to fill the width of the screen, but only slightly stretched taller.
- The top and bottom edges are hidden.

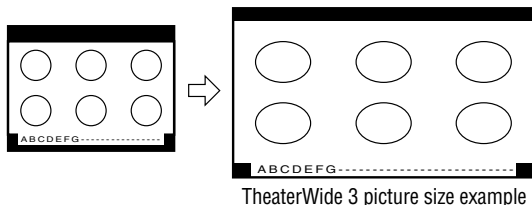

Full picture size (for 4:3 [480i, 480p] source programs only)

- If receiving a 4:3 format program, the picture is stretched wider to fill the width of the screen, but not stretched taller.
- None of the picture is hidden.

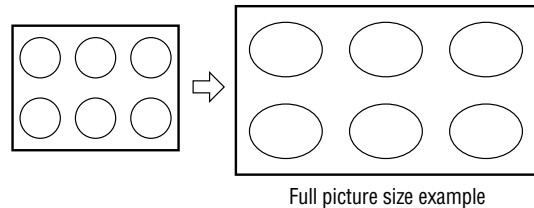

4:3 HD picture size (for 720p, 1080i and 1080p program sources only)

- Sidebars fill the empty vertical spaces.
- Picture is not distorted from original size.

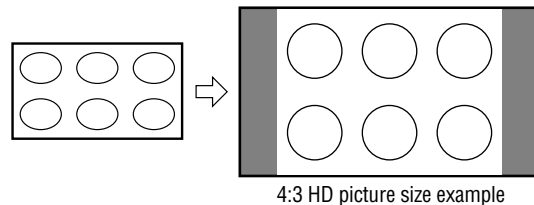

Note:

- If you select one of the TheaterWide® picture sizes, the top and bottom edges of the picture (including subtitles or captions) may be hidden. To view the hidden edges, try viewing the program in **Full** or **Natural** picture size.
- The "picture size" illustrations are examples only. The format of the image (in any of the picture sizes) will vary depending on the format of the signal you are currently watching.

Native picture size (for HDMI 720p, 1080i and 1080p signal programs sources only)

- If receiving a 720p, 1080i or 1080p signal program, Native mode scales the video to display the entire picture within the borders of the screen (i.e. no overscanning).

Note: Depending on the input signals, the border of the picture may be hidden, displayed in black, or noisy.

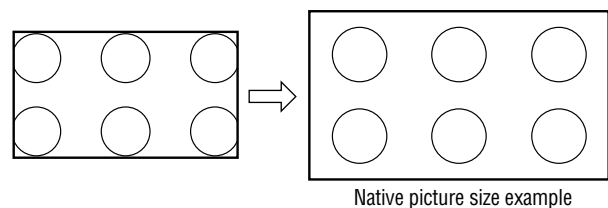

Adjusting the Picture Position

- 1 Press **MENU** and open the **Set Up** menu.
- 2 Press **▲** or **▼** to highlight **Picture Position**, and then press **ENTER**.

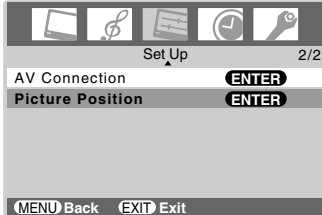

- 3 Press **▲** or **▼** to highlight the item you want to adjust.

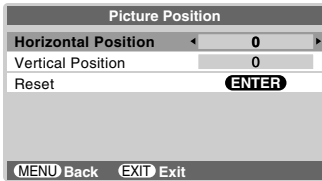

- 4 Press **◀** or **▶** to adjust the settings as required.



The display will return to the previous menu after 4 seconds if no button is pressed.

Selection	Pressing ◀	Pressing ▶
Horizontal Position	Moves picture left	Moves picture right
Vertical Position	Moves picture down	Moves picture up

To reset to the factory-set status:

Follow steps 1-3 above, select **Reset** in step 3, and then press **ENTER**.

Note:

- The *Horizontal Position* can be adjusted for 480i and 480p input signals.
- The *Vertical Position* can be adjusted in *TheaterWide 2* and *TheaterWide 3* modes only.

Using the auto aspect ratio feature

When the auto aspect ratio feature is set to **On**, the picture size is automatically selected when one of the following input sources is received:

- A 480i signal from the **VIDEO-1**, **VIDEO-2**, **ColorStream HD-1**, or **ColorStream HD-2** input.
- A 480i, 480p, 720p, 1080i or 1080p signal from the **HDMI1** or **HDMI2** input.

Aspect ratio of signal source	Automatic aspect size (automatically selected when Auto Aspect is On)
4:3 normal	Natural (with sidebars)
4:3 letter box	TheaterWide 2
16:9 full	Full
Not defined (no ID-1 data or HDMI aspect data)	Selecting the picture size (see page 31)

Note: The auto aspect ratio feature is not applicable to antenna or cable input sources.

To turn on the auto aspect ratio feature:

- 1 Press **MENU** and open the **Function** menu.
- 2 Press **▲** or **▼** to highlight **Auto Aspect**.

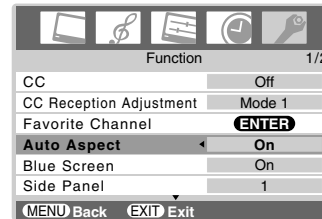

- 3 Press **◀** or **▶** to select **On**.

To turn off the auto aspect ratio feature:

Select **Off** in step 3 above.

Using the blue screen function

When a TV is on but not receiving a signal, the screen typically displays a “snowy” image and the speakers transmit a “static” sound.

With the blue screen function set to **On**, the TV will automatically mute the sound and replace the snowy image with a solid blue screen until the TV receives a signal. Once a signal is received, the normal image and sound are restored.

To turn on the blue screen function:

- 1 Press **MENU** and open the **Function** menu.
- 2 Press **▲** or **▼** to highlight **Blue Screen**.
- 3 Press **◀** or **▶** to select **On**.

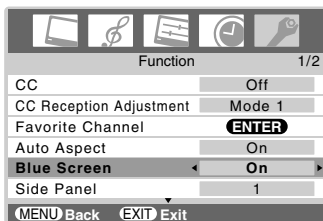

To turn off the blue screen function:

Select **Off** in step 3 above.

Selecting the gray level for 4:3 mode side panels

You can select the gray level of the side panels that display in 4:3 mode.

To select the gray level:

- 1 Press **MENU** and open the **Function** menu.
- 2 Press **▲** or **▼** to highlight **Side Panel**.

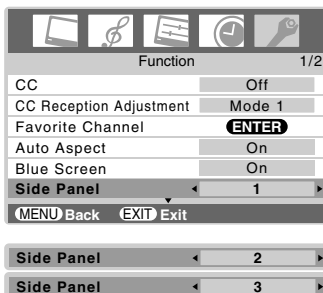

- 3 Press **◀** or **▶** to select the desired gray level (**1**, **2** or **3**), as follows:
 - 1: Black
 - 2: Dark gray
 - 3: Light gray

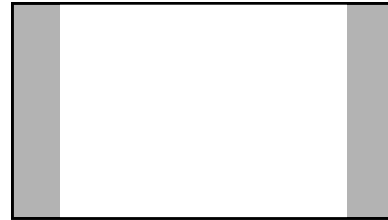

Selecting the cinema mode (480i signals only)

When you view a DVD (480i signal; 3:2 pulldown processed) from a DVD player connected to the **VIDEO-1**, **VIDEO-2**, **ColorStream HD-1/HD-2** (component video), **HDMI1**, or **HDMI2** inputs on the TV, smoother motion can be obtained by setting the **Cinema Mode** to **Film**.

To set the Cinema Mode to Film:

- 1 Press **MENU** and open the **Picture** menu.
- 2 Press **▲** or **▼** to highlight **Cinema Mode**.
- 3 Press **◀** or **▶** to select **Film**.

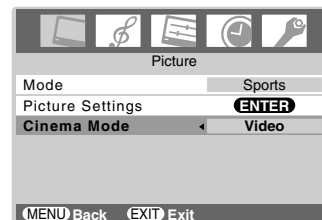

To set the Cinema Mode to Video:

Select **Video** in step 3 above.

Adjusting the picture

Selecting the picture mode

You can select your desired picture settings from four different modes, as described below.

Mode	Picture Quality
Sports	Bright and dynamic picture (factory setting)
Standard	Standard picture settings (factory setting)
Movie	Lower contrast for darkened room (factory setting)
Preference	Your personal preferences

To select the picture mode:

Press **PIC MODE** on the remote control.

The following popup menu appears on-screen.

Standard

Repeatedly press **PIC MODE** to cycle among the modes or use ◀ or ▶ to select the modes.

To select the picture mode using the menu system:

- 1 Press **MENU** and open the **Picture** menu.
- 2 Press ▲ or ▼ to highlight **Mode**.

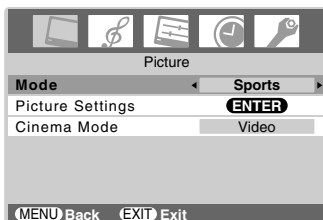

- 3 Press ◀ or ▶ to select the mode you prefer.

Note:

- The picture mode you select affects the current input only. You can select a different picture mode for each input.
- If you select one of the factory-set picture modes (**Sports**, **Standard**, or **Movie**) and then change a picture quality setting (for example, increase the contrast or change the color temperature), the picture mode automatically changes to **Preference** in the **Picture** menu.

Adjusting the picture quality

You can adjust the picture quality (back light, contrast, brightness, color, tint, and sharpness) to your personal preferences.

Selection	Pressing ◀	Pressing ▶
Back Light	darker	lighter
Contrast	lower	higher
Brightness	darker	lighter
Color	paler	deeper
Tint	reddish	greenish
Sharpness	softer	sharper

To adjust the picture quality:

- 1 Press **MENU** and open the **Picture** menu.
- 2 Highlight **Picture Settings** and press **ENTER**.
- 3 Press ▲ or ▼ to select the picture quality you want to adjust (**Back Light**, **Contrast**, **Brightness**, **Color**, **Tint**, or **Sharpness**), and then press ◀ or ▶ to adjust the setting, as described in the table above.

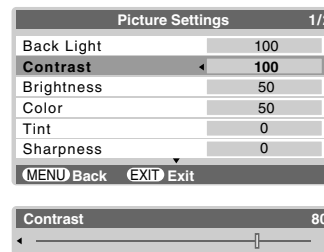

The picture qualities you adjusted are automatically saved in the **Preference** mode (see “Selecting the picture mode,” above left).

Note:

- The cold cathode fluorescent lamp used for the back light on this TV has a limited life. When areas on the screen darken, flicker, or no longer light up, the lamp may be at the end of its life.
- When the TV is in **VIDEO** mode or when no signal is received, the back light feature is automatically set to “0” (zero).

Using the black stretch feature

You can use the black stretch feature to correct the contrast balance in the black areas of the picture. The effect depends on the quality of the video signal.

To turn on the black stretch feature:

- 1 Press **MENU** and open the **Picture** menu.
- 2 Highlight **Picture Settings** and press **ENTER**.
- 3 Press **▲** or **▼** to highlight **Black Stretch**.

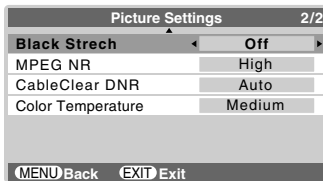

- 4 Press **◀** or **▶** to select **On**.



To turn off the black stretch feature:

Select **Off** in step 4 above.

Using MPEG noise reduction

The MPEG noise reduction feature allows you to reduce visible interference caused by MPEG compression. Choices for MPEG noise reduction are **Off**, **Low**, **Middle**, and **High**. **Off** is automatically selected when this feature is disabled ("grayed out").

To select the MPEG noise reduction level:

- 1 Press **MENU** and open the **Picture** menu.
- 2 Highlight **Picture Settings** and press **ENTER**.
- 3 Press **▲** or **▼** to highlight **MPEG NR**.

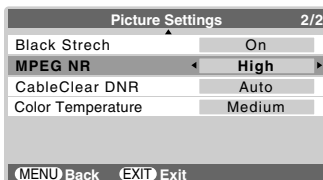

- 4 Press **◀** or **▶** to select **Low**, **Middle**, **High**, or **Off**.



Using CableClear®/DNR (digital noise reduction)

The CableClear® digital noise reduction feature allows you to reduce visible interference in your TV picture. This may be useful when receiving a broadcast with a weak signal (especially a Cable channel) or playing a noisy video cassette or disc.

To turn on the CableClear/DNR settings:

- 1 Press **MENU** and open the **Picture** menu.
- 2 Highlight **Picture Settings** and press **ENTER**.
- 3 Press **▲** or **▼** to highlight **CableClear DNR**.

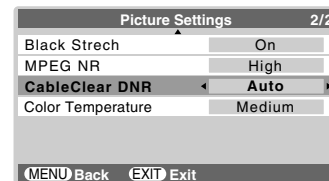

- 4 Press **◀** or **▶** to select **Low**, **Middle**, **High**, or **Auto**.

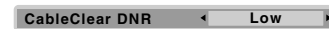

To turn off CableClear DNR:

Select **Off** in step 4 above.

Note:

- The CableClear® DNR feature works with 480i input sources only.
- When the TV is in ColorStream or HDMI mode, the words "CableClear DNR" will change to "DNR" in the menu.
- DNR is not selectable in PC mode.

Selecting the color temperature

You can change the quality of the picture by selecting from three preset color temperatures (Cool, Medium, and Warm), as described below.

Mode	Picture Quality
Cool	blueish
Medium	neutral
Warm	reddish

To select the color temperature:

- 1 Press **MENU** and open the **Picture** menu.
- 2 Highlight **Picture Settings** and press **ENTER**.
- 3 Press **▲** or **▼** to highlight **Color Temperature**.

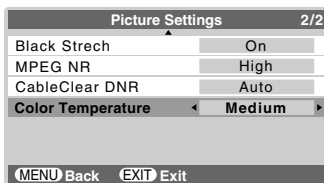

- 4 Press **◀** or **▶** to select the mode you prefer, as described in the table above.

Note: If you select one of the factory-set picture modes (**Sports**, **Standard**, or **Movie**) and then change the color temperature, the picture mode automatically changes to **Preference** in the **Picture** menu.

Using the closed caption mode

The closed caption mode has two options:

- **Captions**—An on-screen display of the dialogue, narration, and sound effects of TV programs and videos that are closed captioned (usually marked “CC” in program guides).
- **Text**—An on-screen display of information not related to the current program, such as weather or stock data (when provided by individual stations).

To view captions or text:

- 1 Press **MENU** and open the **Function** menu.
- 2 Press **▲** or **▼** to highlight **CC**.
- 3 Press **◀** or **▶** to select the desired closed caption mode.

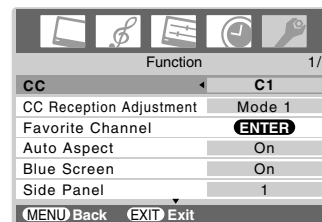

- **To view captions:** Highlight **C1**, **C2**, **C3**, or **C4**. (**C1** displays translation of the primary language in your area.)



Note: If the program or video you selected is not closed captioned, no captions will display on-screen.

- **To view text:** Highlight **T1**, **T2**, **T3**, or **T4**.

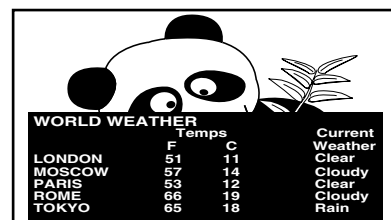

Note: If text is not available in your area, a black rectangle may appear on your screen. If this happens, turn the Closed Caption Mode **Off**.

- **To turn off the Closed Caption mode:** Select **Off** in step 3 above.

(continued)

Note: A closed caption signal may not display in the following situations:

- When a videotape has been dubbed
- When the signal reception is weak
- When the signal reception is non-standard

Closed Caption Reception Adjustment

If reception is weak, the picture may appear blurred, and captions or text may not appear clearly on the screen. In this case, use this function to make them appear clearer.

- 1 Press **MENU** and open the **Function** menu.
- 2 Press **▲** or **▼** to highlight **CC Reception Adjustment**.
- 3 Press **◀** or **▶** to select mode **1** or **2**.

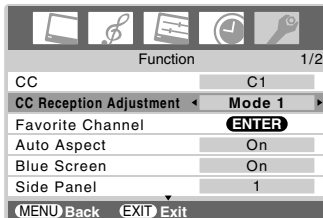

Note:

- This function may not be available in some cases.
- The function is available when the TV is in ANT mode only. The Closed Caption Reception Adjustment function may display the captions more clearly.

Adjusting the audio

Muting the sound

Press **MUTE** to partially reduce (1/2 MUTE) or turn off (MUTE) the sound. Each time you press **MUTE**, the mute mode will change in the following order:



If the closed caption mode is set to **Off** when you select "MUTE" mode, the closed caption feature is automatically activated. To mute the audio without automatically activating the closed caption feature, use **VOL** to set the volume to 0. See "Using the closed caption mode" on page 37 for more information on closed caption modes.

Selecting stereo/SAP broadcasts

The multi-channel TV sound (MTS) feature allows you to output high-fidelity stereo sound. MTS also can transmit a second audio program (SAP) containing a second language, music, or other audio information (when provided by individual analog stations).

The MTS feature is not available when the TV is in VIDEO mode. When the TV receives a stereo or SAP broadcast, the word "STEREO" or "SAP" appears on-screen when **RECALL** is pressed.

To listen to stereo sound:

- 1 Press **MENU** and open the **Audio** menu.
- 2 Press **▲** or **▼** to highlight **MTS**.
- 3 Press **◀** or **▶** to select **Stereo**.

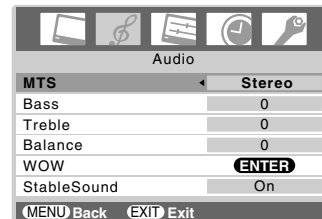

Note:

- You can leave the MTS feature in **Stereo** mode and it will automatically output the type of sound being broadcast (stereo or monaural).
- If the stereo sound is noisy, select **Mono** to reduce the noise.

To listen to a second audio program on an analog station (if available):

Select **SAP** in step 3 above.

Note:

- A second audio program (SAP) can be heard only on those TV stations that offer it. For example, a station might broadcast another language as a second audio program. If you have SAP on, you will see the current program on the screen but hear the other language instead of the program's normal audio.
- If you have SAP on and the station you are watching is not broadcasting a second audio program, the station's normal audio will be output. However, occasionally there is no sound at all in **SAP** mode. If this happens, set the **MTS** feature to **Stereo** mode.

Adjusting the audio quality

You can adjust the audio quality by adjusting the bass, treble, and balance.

To adjust the audio quality:

- 1 Press **MENU** and open the **Audio** menu.
- 2 Press **▼** or **▲** to highlight the item you want to adjust (**Bass**, **Treble**, or **Balance**).

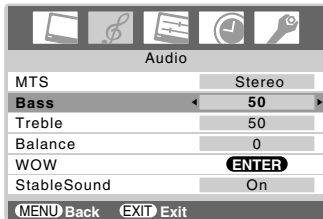

- 3 Press **◀** or **▶** to adjust the level.
 - **◀** makes the bass or treble weaker or increases the balance in the left channel.
 - **▶** makes the bass or treble stronger or increases the balance in the right channel.

Using the SRS WOW™ surround sound feature

WOW™ is a special combination of SRS Labs audio technologies (SRS 3D, FOCUS, and TruBass) that creates a thrilling surround sound experience with deep, rich bass from stereo sound sources. Your TV's audio will sound fuller, richer, and wider.

To adjust the WOW™ settings:

- 1 Put the TV in **Stereo** mode (☞ “Selecting stereo/SAP broadcasts” on page 38).
- 2 Press **MENU** and open the **Audio** menu.
- 3 Highlight **WOW** and press **ENTER**.
- 4 Press **▼** or **▲** to highlight the WOW feature you want to adjust, and then press **◀** or **▶** to adjust the item.

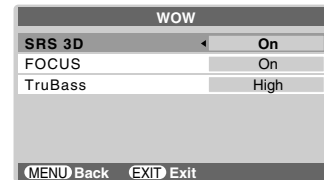

- **SRS 3D** — To turn the surround sound effect **On** or **Off**.

Note: If the broadcast is monaural, the SRS 3D effect will not work.

- **FOCUS** — To turn the vocal emphasis effect **On** or **Off**.
- **TruBass** — To select the desired bass expansion level (**Off**, **Low**, or **High**).

WOW, SRS and  are trademarks of SRS Labs, Inc. WOW technology is incorporated under license from SRS Labs, Inc.

Using the StableSound® feature

The StableSound® feature limits the highest volume level to prevent extreme changes in volume when the signal source changes (for example, to prevent the sudden increase in volume that often happens when a TV program switches to a commercial).

To turn on the StableSound® feature:

- 1 Press **MENU** and open the **Audio** menu.
- 2 Press **▲** or **▼** to highlight **StableSound**.
- 3 Press **◀** or **▶** to select **On**.

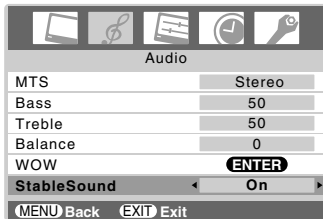

To turn off the StableSound feature:

Select **Off** in step 3 above.

Using the Locks menu

The Locks menu includes the Channel Lock, Video Lock, and New PIN Code features. You can use these features after entering the correct PIN code.

Entering the PIN code

- 1 Press **MENU** and open the **Function** menu.
- 2 Highlight **Locks** and press **ENTER**.
The **Locks** menu appears.

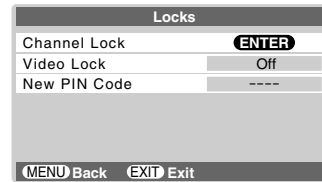

- 3 Press **▲** or **▼** to highlight **Channel Lock** or **Video Lock**, and then press **ENTER** to display the PIN code entering mode.
 - **Blocking Reset status:**
Set a new 4-digit code by pressing the Number buttons (0–9).

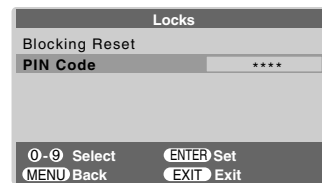

- **When the PIN code is already stored:**
Press the Number buttons (0–9) to enter your 4-digit PIN code.

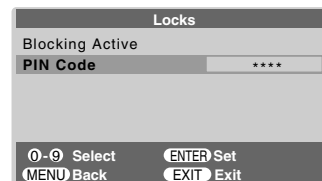

If the wrong PIN code is entered, the message “Incorrect” appears. Enter your code again, and then press **ENTER**.

If you cannot remember your PIN code

While the PIN code entering screen is displayed, press **RECALL** four times within five seconds. The PIN code will be cleared and you can enter a new PIN code.

Changing your PIN code

- 1 Press **MENU** and open the **Function** menu.
- 2 Highlight **Locks** and press **ENTER**.
- 3 Press **▲** or **▼** to highlight **New PIN Code**.

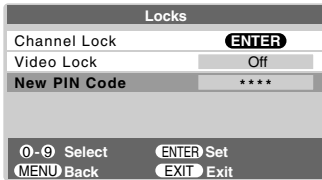

- 4 Press the Number buttons to enter a new four-digit code.
- 5 Press **ENTER**. The new PIN code is now active.

Locking channels

You can use the Channel Lock feature, to lock specific channels. You will not be able to tune locked channels using **CH** or the Channel Number buttons unless you clear the setting.

You can lock a maximum of twelve channels.

To lock channels:

- 1 Press **MENU** and open the **Function** menu.
- 2 Highlight **Locks** and press **ENTER**.
- 3 Highlight **Channel Lock** and press **ENTER**. The **Channel Lock** menu appears, and **Channel Input** will be highlighted.

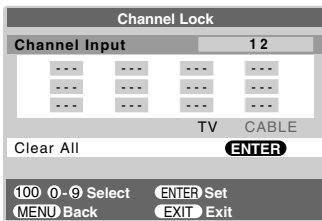

- 4 Press the Channel Number buttons to enter the channel you want to lock.
- 5 Press **ENTER**.

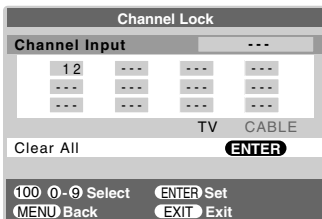

- 6 Repeat steps 4 and 5 for other channels.

Note: After programming Channel Lock, change the channel before turning off the TV.

To unlock individual channels:

In step 4 below left, press **▲▼◀▶** to highlight the channel you want to unlock, and then press **ENTER**.

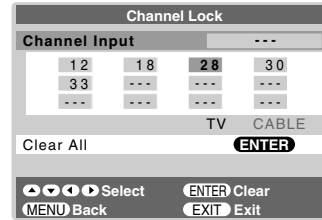

Repeat this step for other channels.

To unlock all locked channels at once:

Press **▲** or **▼** to highlight **Clear All**, and then press **ENTER**.

Using the Video lock feature

You can use the Video Lock feature to lock the video inputs (**Video 1, Video 2, ColorStream HD-1, ColorStream HD-2, HDMI1, HDMI2, and PC**) and channels 3 and 4. You will not be able to view the input sources or channels until you unlock the inputs.

To lock/unlock the video inputs:

- 1 Press **MENU** and open the **Function** menu.
- 2 Highlight **Locks** and press **ENTER**.
- 3 Press **▲** or **▼** to highlight **Video Lock**.
- 4 Press **◀▶** to select the level of video input locking you prefer, as described below.

Video: Locks VIDEO 1, VIDEO 2, ColorStream HD1/HD2, HDMI1, HDMI2, and PC.

Video+: Locks VIDEO 1, VIDEO 2, ColorStream HD1/HD2, HDMI1, HDMI2, PC, and channels 3 and 4.

- Select **Video+** if you play video tapes via an ANT input.

Off: Unlocks all video inputs and channels 3 and 4.

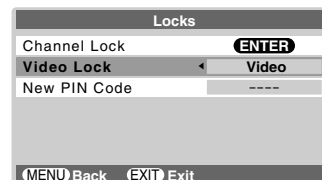

- 5 To close the menu, press **EXIT**.

Using the PC settings feature

You can view an image from a PC on the TV screen. The PC must be connected to the TV's PC IN terminals. (page 16).

You can use a PC Settings feature to adjust the picture's horizontal position/width, vertical position/height, clock phase, and sampling clock.

Note: If a PC is not connected, this feature will be grayed out in the **Set Up** menu.

To adjust the PC settings:

- 1 Repeatedly press **INPUT** to select PC input mode (page "Selecting the video input source to view" on page 30).
- 2 Press **MENU** and open the **Set Up** menu.
- 3 Highlight **PC Settings** and press **ENTER**.



- 4 Press **▲** or **▼** to highlight the item you want to adjust.
- 5 Press **◀** or **▶** to make the appropriate adjustments.

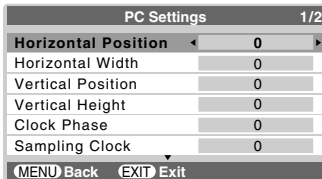

- **Horizontal Position:**
Moves the picture left/right.
The adjustment range is within ± 5 from center.*
- **Horizontal Width:**
Adjusts the width of the picture.
The adjustment range is within ± 5 from center.*
- **Vertical Position:**
Moves the picture up/down.
The adjustment range is within ± 5 from center.*
- **Vertical Height:**
Adjusts the height of the picture.
The adjustment range is within ± 5 from center.*
- **Clock Phase:**
Helps to reduce noise and sharpen the picture.
The adjustment range is within ± 15 from center.*

- **Sampling Clock:**
Helps to minimize periodic vertical stripes on the screen.
The adjustment range is within ± 15 from center.*
- **Reset:**
To reset the PC setting, select **Reset** and press **ENTER**.

*The range of adjustment may vary slightly.

Setting the PC Audio

This function allows you to output the sound from your PC (if connected) or mute the sound from your PC and output the sound from your HDMI (DVI) connection (page 15).

To set the PC Audio:

- 1 Press **MENU** and open the **Set Up** menu.
- 2 Highlight **AV Connection** and press **ENTER**.
- 3 Press **▲** or **▼** to select **PC/HDMI1 Audio**, and then press **◀** or **▶** to select **PC** or **HDMI1**.

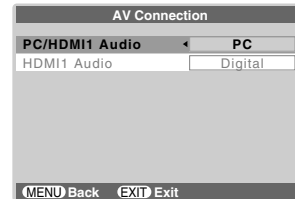

PC: Mutes the sound from the HDMI device, and outputs the sound from the PC

HDMI1: Mutes the sound from your PC, and outputs the sound from the HDMI device

Note:

- The **PC/HDMI1 Audio** switch setting influences the **HDMI1 Audio** setting. If it is set to **HDMI1**, the **HDMI1 Audio** setting changes to **Auto**. If it is set to **PC**, the **HDMI1 Audio** setting is set to **Digital** and will be grayed out.
- The **PC IN** and **HDMI1 IN** terminals share the audio inputs labeled **PC/HDMI1 (AUDIO)** on the TV back panel.
- If you have both a PC and an HDMI device connected to the TV, use the PC Audio setting to specify which audio (PC or HDMI) will be output from the TV's speakers. Also see pages 15 and 16.

Setting the sleep timer

You can set the sleep timer to turn off the TV after a set length of time (maximum of 12h50m).

To set the sleep timer:

Press **SLEEP** on the remote control to set the length of time until the TV turns off. Repeatedly press **SLEEP** to increase the time in 10-minute increments, or press **▲** or **▼** to increase or decrease the time in 10-minute increments, up to 12h50m.

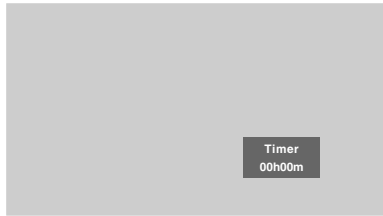

To cancel the sleep timer:

Press **SLEEP** until it is set to 00h00m.

To set the sleep timer using the on-screen menus:

- 1 Press **MENU** and open the **Timer** menu.
- 2 Press **▲** or **▼** to highlight **Sleep Timer**.

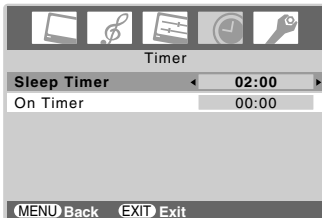

- 3 Press the Number buttons (0–9) or **◀** or **▶** to enter the length of time until the TV turns off automatically.
- 4 Press **EXIT** to start the timer.

Note:

- When a power failure occurs, the sleep timer setting may be cleared.
- To display the amount of time remaining on the sleep timer, press **RECALL**.

Setting the On timer

To set the On timer to turn on the TV automatically:

- 1 Press **MENU** and open the **Timer** menu.
- 2 Press **▲** or **▼** to highlight **On Timer**.
- 3 Press the Number buttons (0–9) or **▲** or **▼** to enter the length of time until the TV turns on automatically.
You can set the On timer in 10-minute increments, up to 12h50m.
- 4 Press **EXIT** to start the timer.

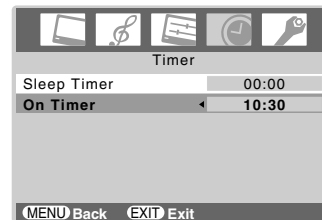

- 5 Press **POWER** to turn off the TV.
The TV will turn on automatically after the length of time you set in the On timer.

Note:

- When a power failure occurs, the On timer settings may be cleared.
- To display the amount of time remaining on the On timer (while the TV is still on), press **RECALL**.

Displaying TV setting information on-screen using RECALL

To display TV setting information on-screen:

Press **RECALL** on the remote control.

The following information will display on-screen (if applicable):

- Channel number or VIDEO mode selected
- Remaining time of On/Sleep timer (if set)
- Channel label (if set)
- Video label (when in video mode)
- Stereo or SAP audio status
- Picture size

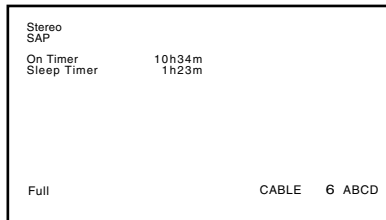

To close the RECALL screen:

Press **RECALL** again.

Understanding the auto power off feature

The TV will automatically turn itself off after approximately 15 minutes if it is tuned to a vacant channel or a station that completes its broadcast for the day. This feature does not work in VIDEO mode.

Understanding the last mode memory feature

If the power is cut off while you are viewing the TV, the Last Mode Memory feature automatically turns on the TV when the power is resupplied.

Note: You should unplug the TV's power cord if it is possible that you will be away from the TV for an extended period of time after the power is restored. This will prevent the TV from turning on in your absence.

Chapter 7: Troubleshooting

General troubleshooting

Before calling a service technician, please check this section for a possible cause of the problem and some solutions you can try.

Black box on screen

- The Closed Caption feature is set to one of the Text modes (**T1**, **T2**, **T3**, or **T4**). Set the Closed Caption feature to **Off** (☞ page 37).

TV will not turn on

- Make sure the power cord is plugged in, and then press **POWER**.
- The remote control batteries may be dead. Replace the batteries or try the control panel buttons.

Picture problems

General picture problems

- Check the antenna/cable connections (☞ page 10).
- Press **(INPUT)** on the remote control or **INPUT** on the TV control panel and select a valid video input source (☞ page 30). If no device is connected, no picture will display when you select that particular input source. For device connection details, see page 10.
- Antenna reception may be poor. Use a highly directional outdoor antenna (if applicable).
- The station may have broadcast difficulties. Try another channel.
- Adjust the picture qualities (☞ page 35).
- If you are using a VCR, make sure **TV/VCR** on the remote control is set correctly (☞ page 19).
- Do not connect both a standard video cable and an S-video cable to the **VIDEO-2** inputs at the same time (☞ page 12).

Noisy picture

- If you are watching a tuned analog channel (off-air broadcast or Cable TV), set the **CableClear®/DNR** feature to **Auto** to reduce visible interference in the TV picture (☞ page 36).

Video Input Selection problems

- If the program list does not appear when you press **(INPUT)** on the remote control or **INPUT** on the TV control panel, press the button a second time, which will change the TV to the next video input source and display the program list.

Cannot view external signals or channel 3 or 4

- If you cannot view signals from external devices connected to **VIDEO-1**, **VIDEO-2**, **ColorStream®**, **HDMI1**, **HDMI2**, **PC** or from channels 3 or 4, make sure the **Video Lock** is set to **Off** (☞ page 41).

Poor color or no color

- The station may have broadcast difficulties. Try another channel.
- Adjust the **Tint** and/or **Color** (☞ page 35).

Poor composite or S-video picture

- If the poor picture occurs when the TV is connected to an external A/V device (e.g., DVD player, video game system, set-top box, etc.) try using a **ColorStream** or **HDMI** video connection instead.

Picture and sound are out of sync

- As with all products that contain a digital display, in rare instances, when viewing certain content (e.g., television broadcasts, video games, DVDs), you may notice that the sound and picture are slightly out of sync. This phenomenon can be caused by various factors including, without limitation, video processing within the TV, video processing in an attached gaming system, and video processing or different compression rates used by broadcasters in their programming. You may want to try one or more of the following suggestions, which may help to reduce the effect of this phenomenon:
 - If the TV is connected to an A/V receiver that has a programmable audio delay feature, use this feature to help synchronize the sound to the picture.
 - If you notice this phenomenon only on certain TV channels, please contact your local broadcast, cable, or satellite provider to inform them of this issue.

Sound problems

- Check the antenna/cable connections (☞ page 10).
- The station may have broadcast difficulties. Try another channel.
- The sound may be muted. Press **VOLUME**.
- If you hear no sound, try setting the **MTS** feature to **Stereo** mode (☞ page 38).
- If you are not receiving a second audio program from a known SAP source, make sure the **MTS** feature is set to **SAP** mode (☞ page 38).
- If you hear audio that seems “incorrect” for the program you are watching (such as music or a foreign language), the SAP mode may be on. Set the **MTS** feature to **Stereo** mode (☞ page 38).

Remote control problems

- Make sure the remote control is set to the correct device mode (🔍 page 19).
- Remove all obstructions between the remote control and the TV.
- The remote control batteries may be dead. Replace the batteries (🔍 page 17).
- The TV remote control may not operate certain features on your external device. Refer to the owner's manual for your other device to determine its available features. If the TV remote control does not operate a specific feature on the device, use the remote control provided with the device (🔍 pages 19–23).

Channel tuning problems

- Make sure the remote control is set to the correct device mode (🔍 page 18).
- The channel may have been erased from the channel memory by the **Add/Erase** feature. Add the channel to the channel memory (🔍 page 27).
- The channel may be blocked by the **Channel Lock** feature. Unblock the channel (🔍 page 41).

Closed caption problems

- If the program or video you selected is not closed-captioned, no captions will display on-screen (🔍 page 37).
- If text is not available, a black rectangle may appear on-screen. If this happens, turn off the closed caption feature (🔍 page 37).
- A closed caption signal may not display correctly in the following situations: a) when a videotape has been dubbed; b) when the signal reception is weak; or c) when the signal reception is nonstandard (🔍 page 37).

Specifications

Notes:

- **This model complies with the specifications listed below.**
- **Designs and specifications are subject to change without notice.**
- **This model may not be compatible with features and/or specifications that may be added in the future.**

Television System

NTSC standard

Channel Coverage

VHF: 2 through 13

UHF: 14 through 69

Cable TV: Mid band (A-8 through A-1, A through I)

Super band (J through W)

Hyper band (AA through ZZ, AAA, BBB)

Ultra band (65 through 94, 100 through 125)

Power Source

120 V AC, 60 Hz

Power Consumption

26HL57: 80 W (average)

0.6 W in standby mode

32HL57: 95 W (average)

0.6 W in standby mode

37HL57: 123 W (average)

0.6 W in standby mode

42HL57: 157 W (average)

0.4 W in standby mode

Audio Power

10 W + 10 W

Speaker Type

2-3/8 × 4-3/4 inches (60 × 120 mm)

Video/Audio Terminals

S-VIDEO INPUT:

Y: 1 V(p-p), 75 ohm, negative sync.

C: 0.286 V(p-p) (burst signal), 75 ohm

VIDEO/AUDIO INPUT:

VIDEO: 1 V(p-p), 75 ohm, negative sync.

AUDIO: 150 mV(rms) (30% modulation equivalent, 22 k ohm or greater)

ColorStream® (component video) HD INPUT:

VIDEO:Y: 1V(p-p), 75 ohm

Pr: 0.7 V(p-p), 75 ohm

Pb: 0.7 V(p-p), 75 ohm

Suggested formats: 1080i, 720p, 480p, 480i

AUDIO: 150 mV(rms), 22 k ohm or greater

HDMI™ INPUT:

HDMI compliant (type A connector)

HDCP compliant

E-EDID* compliant

Suggested formats: 1080p (24/60Hz), 1080i (60Hz), 720p (60Hz), 480p (60Hz), 480i (60Hz)

HDMI Audio: 2-channel PCM; 32/44.1/48 kHz sampling frequency; 16/20/24 bits per sample

FIXED AUDIO OUTPUT:

150 mV(rms) (30% modulation equivalent, 2.2 k ohm or less)

PC INPUT:

15-Pin D-sub Analog RGB

Pin No.	Signal name	Pin No.	Signal name
1	R	9	NC
2	G	10	Ground
3	B	11	NC
4	NC (Not connected)	12	NC
5	NC	13	H-sync
6	Ground	14	V-sync
7	Ground	15	NC
8	Ground		

Dimensions

26HL57: Width: 26-1/4 inches (666 mm)
Height: 20-1/4 inches (514 mm)

Depth: 9-1/2 inches (241 mm)

32HL57: Width: 31-1/2 inches (800 mm)
Height: 23-3/8 inches (592 mm)

Depth: 11-1/4 inches (285 mm)

37HL57: Width: 36-1/4 inches (920 mm)
Height: 26-1/8 inches (661 mm)

Depth: 11-1/4 inches (285 mm)

42HL57: Width: 40-1/2 inches (1,027 mm)
Height: 28-5/8 inches (724 mm)

Depth: 13-1/4 inches (335 mm)

Mass (weight)

26HL57: 28.7 lbs (13.0 kg)

32HL57: 38.6 lbs (17.5 kg)

37HL57: 46.3 lbs (21.0 kg)

42HL57: 59.5 lbs (27.0 kg)

Operating conditions

Temperature: 32°F - 95°F (0°C - 35°C)

Humidity: 20 - 80% (no moisture condensation)

Supplied Accessories

- Remote control with two size “AAA” batteries
- Owner’s Manual (this book)
- Lead Clip—Use this clip to attach the TV to a wall, pillar, or other immovable structure. See item 20 on page 3.

* E-EDID = Enhanced-Extended Display Identification

Limited Canadian Warranty for Toshiba Brand Flat Panel Televisions

Toshiba of Canada Limited ("TCL") makes the following limited warranties to original consumers in Canada. THESE LIMITED WARRANTIES EXTEND TO THE ORIGINAL CONSUMER PURCHASER OR ANY PERSON RECEIVING THIS TOSHIBA BRAND FLAT PANEL TELEVISION (the "TELEVISION(S)" or "Television(s)") AS A GIFT FROM THE ORIGINAL CONSUMER PURCHASER AND TO NO OTHER PURCHASER OR TRANSFEREE.

TELEVISIONS PURCHASED IN CANADA, AND USED ANYWHERE OUTSIDE OF CANADA INCLUDING, WITHOUT LIMITATION, THE UNITED STATES AND MEXICO, ARE NOT COVERED BY THESE WARRANTIES.

TELEVISIONS PURCHASED ANYWHERE OUTSIDE OF CANADA, INCLUDING, WITHOUT LIMITATION, THE UNITED STATES AND MEXICO, AND USED IN CANADA, ARE NOT COVERED BY THESE WARRANTIES.

Limited One (1) Year Warranty on Parts and Labour

Subject to the more limited warranty if the Television is used for any commercial or business purposes as set out below, TCL warrants the Television and its parts against material defects in materials or workmanship that result in the Television failing for a period of one (1) year after the date of original retail purchase. DURING THIS PERIOD, TCL WILL, AT TCL'S OPTION, REPAIR OR REPLACE A DEFECTIVE PART WITH A NEW OR REFURBISHED PART WITHOUT CHARGE TO YOU FOR PARTS OR LABOUR.

- (a) FOR TELEVISIONS 32 INCHES OR LESS: YOU MUST DELIVER THE ENTIRE TELEVISION TO A TCL TELEVISION AUTHORIZED SERVICE PROVIDER ("ASP"). YOU MUST PAY FOR ALL TRANSPORTATION AND INSURANCE CHARGES FOR THE TELEVISION TO AND FROM THE ASP.
- (b) FOR TELEVISIONS OVER 32 INCHES: During this period, ASP personnel will come to your home when warranty service is required. Depending on the type of repair required, the service will either be performed in your home or the Television will be taken to an ASP for repair and returned to your home at no cost to you. **IN-HOME SERVICE ONLY APPLIES WITHIN 100 KILOMETERS OF AN ASP. IF YOU ARE NOT WITHIN 100 KILOMETERS OF AN ASP, YOU MUST DELIVER THE ENTIRE TELEVISION TO AN ASP. YOU MUST PAY FOR ALL TRANSPORTATION AND INSURANCE CHARGES FOR THE TELEVISION TO AND FROM THE ASP.**

Limited Warranty for Commercial Units

TCL warrants Televisions that are used for any commercial or business purposes as follows: all parts are warranted against material defects in materials or workmanship that result in the Television failing for a period of ninety (90) days after the date of original retail purchase. DURING THIS PERIOD, TCL WILL, AT TCL'S OPTION, REPAIR OR REPLACE THE DEFECTIVE PART WITH A NEW OR REFURBISHED PART WITHOUT CHARGE TO YOU.

- (c) FOR TELEVISIONS 32 INCHES OR LESS: YOU MUST DELIVER THE ENTIRE TELEVISION TO AN ASP. YOU MUST PAY FOR ALL TRANSPORTATION AND INSURANCE CHARGES FOR THE TELEVISION TO AND FROM THE ASP.

- (d) FOR TELEVISIONS OVER OVER 32 INCHES: During this period, ASP personnel will come on-site when warranty service is required. Depending on the type of repair required, the service will either be performed on-site or the Television will be taken to an ASP for repair and returned at no cost to you. **ON-SITE SERVICE ONLY APPLIES WITHIN 100 KILOMETERS OF AN ASP. IF YOU ARE NOT WITHIN 100 KILOMETERS OF AN ASP, YOU MUST DELIVER THE ENTIRE TELEVISION TO AN ASP. YOU MUST PAY FOR ALL TRANSPORTATION AND INSURANCE CHARGES FOR THE TELEVISION TO AND FROM THE ASP.**

Rental Units

The warranty for Television rental units begins with the date of first rental or thirty (30) days from the date of shipment to the rental firm, whichever comes first.

Your Responsibility

THE ABOVE WARRANTIES ARE SUBJECT TO THE FOLLOWING CONDITIONS:

- (1) You must provide your bill of sale or other proof of purchase.
- (2) All warranty servicing of this Television must be performed by an ASP.
- (3) The warranties from TCL are effective only if the Television is (i) purchased as new and unopened from TCL or from TCL's authorized distributors, dealers or resellers ("ADR's") and (ii) located/operated in Canada.
- (4) Labour charges for set installation, setup, adjustment of customer controls, and installation or repair of antenna systems are not covered by these warranties. Reception problems caused by inadequate antenna systems are your responsibility.
- (5) Warranties extend only to material defects in materials or workmanship as limited above, and do not extend to:
 - a. Service, repairs or replacement made necessary by accident, misuse, abuse, moisture, liquids, dust, dirt, neglect, accident, damage, 24/7 applications, improper installation, improper operation, improper cleaning, improper maintenance, normal wear and tear, screen burn or image retention caused by prolonged display of static images and/or phosphor aging, or any other external cause or event, act or omission outside the control of TCL, including fire, theft, acts of God, alteration, power failures, power surges or power shortages, lightning, other electrical faults, or repairs, modifications or replacements by persons other than those authorized by TCL to service the Television;
 - b. Replacement of missing, discarded or lost parts, the provision of retrofits, or preventive maintenance;
 - c. Repair of damage that is cosmetic only or does not affect the Television functionality, such as wear and tear, scratches and dents;
 - d. Service on Toshiba-branded accessory items (such accessory items may be covered by their own warranty);
 - e. Service on third party products or service made necessary by use of incompatible third party products;
 - f. Service made necessary by the simultaneous use of this Television and connected equipment;
 - g. Modifications to the Television not approved in writing by TCL, and service made necessary by the use or installation of non-Toshiba modifications to the Television;
 - h. Service of a Television on which the TOSHIBA label or logo, rating label or serial number have been defaced or removed;
 - i. On-site service and repair of the Television; and
 - j. Damage to the Television caused by failure to follow the specifications, User manuals or guides as to usage and/or storage.

Disclaimer and Limitation of Remedy

TO THE EXTENT NOT PRECLUDED BY LAW, ALL OTHER EXPRESS AND IMPLIED WARRANTIES, CONDITIONS AND REPRESENTATIONS FOR THIS TELEVISION, INCLUDING THE IMPLIED WARRANTIES, CONDITIONS AND REPRESENTATIONS OF MERCHANTABILITY AND FITNESS FOR A PARTICULAR PURPOSE, ARE HEREBY DISCLAIMED AND EXCLUDED. IF THE APPLICABLE LAW, STATUTORY OR OTHERWISE, PRECLUDES THE EXCLUSION OF ANY IMPLIED WARRANTIES, CONDITIONS AND REPRESENTATIONS THEN SUCH IMPLIED WARRANTIES, CONDITIONS AND REPRESENTATIONS ARE OTHERWISE LIMITED IN DURATION TO THE TERM OF THIS EXPRESS WRITTEN LIMITED WARRANTY. TO THE EXTENT NOT PRECLUDED BY LAW, STATUTORY OR OTHERWISE, THIS WRITTEN WARRANTY SUPERCEDES AND SPECIFICALLY DISCLAIMS ANY OTHER WARRANTY, CONDITION OR REPRESENTATION NOT STATED IN THIS WARRANTY, WHETHER MADE BY TCL, TOSHIBA CORPORATION, THEIR AFFILIATES, ADRs AND ASPs AND WHETHER MADE ORALLY OR IN WRITING (INCLUDING ANY STATEMENT IN ANY BROCHURE, PRESS RELEASE, ANNOUNCEMENT, ADVERTISEMENT, POINT OF SALE DISPLAY, ETC.).

YOU MUST READ AND FOLLOW ALL SET-UP AND USAGE INSTRUCTIONS IN THE APPLICABLE USER GUIDES AND/OR MANUALS. IF YOU FAIL TO DO SO, THIS TELEVISION MAY NOT FUNCTION PROPERLY AND YOU MAY SUFFER DAMAGE. THIS WARRANTY WILL NOT COVER ANY SERVICE THAT IS REQUIRED, IN PART OR IN WHOLE, AS A RESULT OF ANY FAILURE TO FOLLOW THE SET-UP AND USAGE INSTRUCTIONS. THIS WARRANTY DOES NOT APPLY AND SHALL BE VOID AND UNENFORCEABLE IF THE TELEVISION IS OPENED, SERVICED, OR REPAIRED BY PERSONS OTHER THAN THOSE AUTHORIZED BY TCL TO SERVICE OR REPAIR THE TELEVISION.

IF THE TELEVISION FAILS TO WORK AS WARRANTED ABOVE, YOUR SOLE AND EXCLUSIVE REMEDY SHALL BE REPAIR OR REPLACEMENT OF THE DEFECTIVE PART. IN NO EVENT WILL TCL, TOSHIBA CORPORATION, THEIR AFFILIATES, ADRs OR ASPs (THE "RELATED PARTIES") BE LIABLE TO YOU OR ANY THIRD PARTY FOR ANY DAMAGES, MONEY, REIMBURSEMENT, COSTS OR EXPENSES. THIS LIMITATION APPLIES TO DAMAGES, MONEY, REIMBURSEMENT, COSTS OR EXPENSES OF ANY KIND WHATSOEVER INCLUDING ANY DIRECT OR INDIRECT DAMAGES, DAMAGE TO PROPERTY OR PERSON, LOST PROFITS, LOST SAVINGS, INCONVENIENCE OR OTHER SPECIAL, INCIDENTAL, EXEMPLARY OR CONSEQUENTIAL DAMAGES, WHETHER FOR BREACH OF WARRANTY, BREACH OF CONTRACT, TORT (INCLUDING NEGLIGENCE), UNDER A STATUTE OR UNDER ANY OTHER LAW OR FORM OR ACTION, OR WHETHER ARISING OUT OF THE USE OF OR INABILITY TO USE THE TELEVISION, EVEN IF ANY OF THE RELATED PARTIES HAS BEEN ADVISED OF THE POSSIBILITY OF SUCH DAMAGES OR OF ANY CLAIM BY ANY OTHER PARTY.

No person, agent, distributor, dealer or company is authorized to change, modify or extend the terms of these warranties in any manner whatsoever.

Arbitration and Dispute Resolution

To the extent not precluded by law, any claim, dispute, controversy or disagreement (whether for breach of warranty, breach of contract, tort (including negligence), under a statute or under any other law or form of action) against any of the Related Parties arising out of, or otherwise relating to: (i) this warranty; (ii) the Television; (iii) any oral or written representations, statements, brochures, press releases, advertising, announcement, point of sale display, or promotional material relating to the Television; (iv) the relationships that result from this warranty, (the foregoing claims, disputes controversies and disagreements are collectively referred to as the "Dispute"), shall be referred to and resolved by final and binding arbitration (to the exclusion of the courts). To the extent not precluded by law, you agree to waive any right that you may have to commence or participate in any representative or class proceeding against the Related Parties relating to any Dispute. If and where applicable and to the extent not precluded by law, you further

agree to opt out of any such representative or class proceedings. Arbitration of any Dispute will be conducted in the forum and in the manner as agreed to between you and TCL. Failing such agreement, the arbitration will be conducted by one arbitrator pursuant to the laws and rules relating to arbitration generally in force in the jurisdiction in which you reside at the time that the Dispute arises. To the extent not precluded by law, no claim, dispute, controversy or disagreement of any other person may be joined or combined with any Dispute by you, without the prior written consent of TCL.

Critical Applications

The Television you have purchased is not designed for any "critical applications." "Critical applications" means life support systems, medical applications, connections to implanted medical devices, commercial transportation, nuclear facilities or systems or any other applications where Television failure could lead to injury to persons or loss of life or catastrophic property damage.

IF THE CUSTOMER USES THE TELEVISION IN ANY CRITICAL APPLICATION, THE CUSTOMER - AND NOT TCL, ITS AFFILIATES, ADRs OR ASPs - ASSUME SOLE AND FULL RESPONSIBILITY FOR SUCH USE. TCL RESERVES THE RIGHT TO REFUSE TO SERVICE ANY TELEVISION USED IN A CRITICAL APPLICATION. TCL, ITS AFFILIATES, ADRs AND ASPs HEREBY DISCLAIM ANY AND ALL LIABILITY, DAMAGES AND CONSEQUENCES ARISING OUT OF THE SERVICE OR REFUSAL TO SERVICE SUCH TELEVISION AND FURTHER DISCLAIM ANY AND ALL LIABILITY, CONSEQUENCES AND DAMAGES THAT MAY ARISE OR RESULT FROM THE USE OF THE TELEVISION IN ANY CRITICAL APPLICATIONS.

General Provisions

If and to the extent that any provision of this limited warranty should generally be found to be unenforceable, the unenforceable provision shall be severed from the warranty and deemed not to form part of the warranty. The remaining provisions of this warranty shall be and remain valid and enforceable. If and to the extent that any provision of this limited warranty as it relates to any of the Related Parties is found to be invalid or unenforceable in respect of that party (the "Excluded Party"), the Excluded Party shall be deemed to be severed or excluded from the provision, and the provision shall remain valid, enforceable and applicable in respect of the other or remaining Related Parties.

To the extent permitted by law, this limited warranty shall be governed and construed in accordance with the laws of Ontario.

If there is any inconsistency between this limited warranty, on the one hand, and any statement in the packaging of the Television or in any other document enclosed with, or used in the context of the promotion or sale of, the Television, on the other hand, the provisions of this limited warranty shall prevail.

How to Obtain Warranty Services

If, after following all of the operating instructions in this manual and checking the "Troubleshooting" section, you find that service is needed:

- (1) To find the nearest ASP, visit TCL's web site at www.toshiba.ca, or call toll free 1-800-268-3404
- (2) Present your bill of sale or other proof of purchase to the ASP.

For additional information, visit TCL's website at www.toshiba.ca

Index

- A**
- Antenna cable 10
 - Audio quality adjustments 39
 - Auto aspect 33
 - Auto power off 44
- B**
- Back of the TV 9
 - Blue screen 34
- C**
- Cable box connection 12
 - CableClear DNR 36
 - Camcorder connection 14
 - CC Reception Adjustment 38
 - CH ▲▼ buttons 31
 - CH RTN button 31
 - Channel Number buttons 31
 - Channel programming
 - Automatic programming 26
 - Manually adding and deleting... 27
 - Cinema mode 34
 - Closed captions 37
 - Color temperature 37
 - ColorStream® 13
 - Component video 13
 - Component video cables 10
 - Connecting Cables 10
- D**
- DNR (Digital Noise Reduction) 36
 - DVD player connection 13
 - DVI connection 15
- F**
- Favorite channels 27
 - Features, TV 7
 - Front of the TV 8
- H**
- HDMI audio mode 29
 - HDMI cable 10
 - HDMI™ connection 15
- I**
- Installation, care, and service 3
 - Installation, setup 7
- L**
- Labeling video input 30
 - Language selection 26
 - Last mode memory feature 44
 - Lip Sync Latency 29
 - Locks menu
 - New PIN code 41
 - Video inputs, locking 41
- M**
- MPEG noise reduction 36
 - MTS feature 38
 - MUTE button 38
- P**
- PC connection 16
 - PC setting 42
 - Picture adjustment 35
 - Picture mode 35
 - Picture quality 35
 - Picture size selection 31
 - POWER button 8
- R**
- RECALL button 44
 - Remote control
 - Battery installation 17
 - Device code table 22
 - Effective range 17
 - Functional key chart 20
 - Learning about the buttons 18
 - Programming 21
- S**
- Safety 2
 - SAP sound 38
 - Satellite receiver connection 13
 - Selecting Menu Language 26
 - Service 4
 - Side panel control 8
 - Sleep timer 43
 - Specifications 47
 - StableSound® 40
 - Stereo sound 38
 - S-video cable 10
- T**
- TheaterWide® picture size 32
 - Troubleshooting 45
- V**
- VCR connection 11, 12, 13
 - Video cables 10
 - Video input label 30
 - Video input lock 41
- W**
- Warranty
 - Canada 48
 - WOW:Focus 39
 - WOW:SRS 3D 39
 - WOW:TruBass 39

Notes

TOSHIBA OF CANADA LTD.

HEAD OFFICE: 191 McNABB STREET, MARKHAM, ONTARIO, L3R 8H2, CANADA – TEL: (905) 470-5400

SERVICE CENTERS:

TORONTO: 191 McNABB STREET, MARKHAM, ONTARIO L3R 8H2, CANADA – TEL: (905) 470-5400

MONTREAL: 18050 TRANS CANADA, KIRKLAND, QUEBEC, H9J 4A1, CANADA – TEL: (514) 390-7766

VANCOUVER: 13551 COMMERCE PARKWAY, SUITE 110, RICHMOND, B.C., V6V 2L1, CANADA – TEL: (604) 303-2500

MANUFACTURED BY

TOSHIBA ELECTROMEX, S.A. DE C.V.

CableClear, ColorStream, StableSound, and TheaterWide are registered trademarks of Toshiba America Consumer Products, L.L.C.

PRINTED IN USA
(07-04)

TOSHIBA

Free Manuals Download Website

<http://myh66.com>

<http://usermanuals.us>

<http://www.somanuals.com>

<http://www.4manuals.cc>

<http://www.manual-lib.com>

<http://www.404manual.com>

<http://www.luxmanual.com>

<http://aubethermostatmanual.com>

Golf course search by state

<http://golfingnear.com>

Email search by domain

<http://emailbydomain.com>

Auto manuals search

<http://auto.somanuals.com>

TV manuals search

<http://tv.somanuals.com>