

Operating Instructions

Color Video Monitor

Model No. **BT-S915DA**

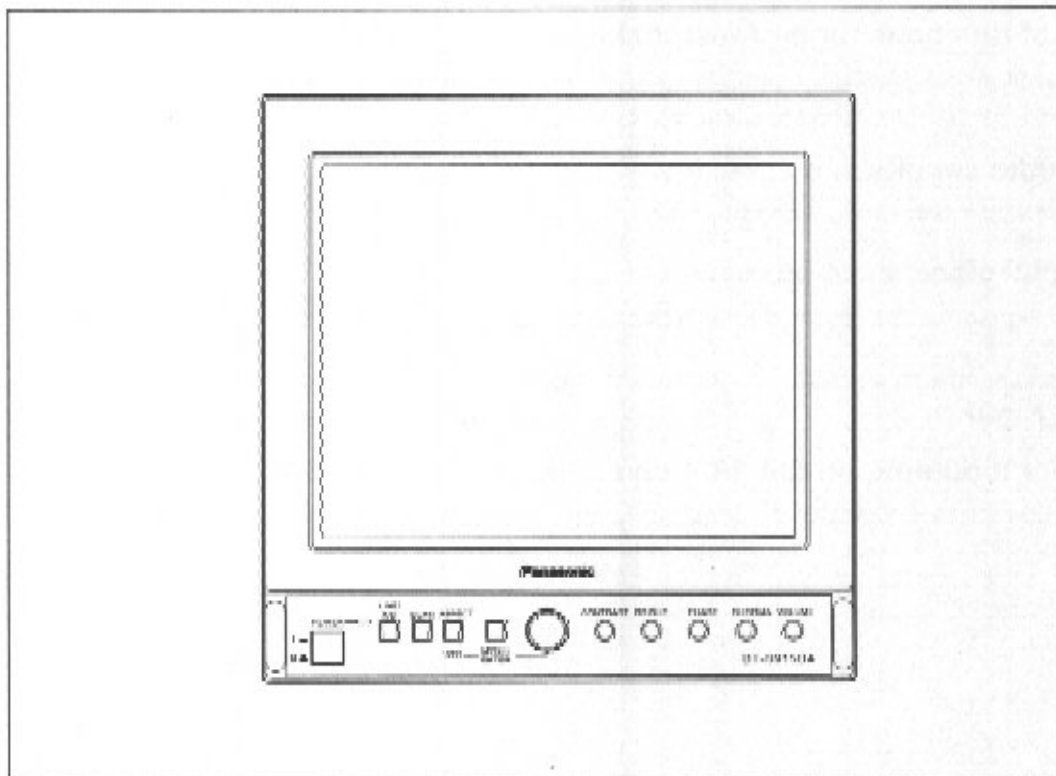

Main features	2	Location of Connectors	6
IMPORTANT SAFETY NOTICE	3	Control Menu Operation	7
Precautions	4	Specifications	15
Operation of Front Panel Controls	5		

Panasonic®

Read these instructions completely before operating this unit.

TOBJ0038

Main features

1. 3 color video formats

Compatible with NTSC, PAL and SECAM formats, and switches between them automatically when required. In addition, a COMB filter ensures that fine-resolution pictures with almost no cross-color can be obtained when NTSC signals are being received.

2. Compatible with a variety of input signals

In addition to composite video signals and S-VIDEO (Y/C) signals, component (YPbPr) signals and RGB signals can also be input.

3. Aspect selection

The aspect ratio can be switched between 4:3 and 16:9 by pressing a button at the front of the unit. In addition, an external device can be used to change the aspect ratio if the device is connected to the REMOTE terminal at the rear of this unit.

4. Easy setup using on-screen menus

On-screen menus allow easy adjustment of settings such as color temperature (6500 K, 9300 K or USER), white balance, input selection and other settings (such as component level selection and setup selection).

5. A variety of functions for professional use

Additional functions for professional use include underscan, blue-only screen mode, external synchronization input terminals, component level selection and setup selection.

6. Built-in audio circuits and speakers

Audio circuits with 1.0 W output (monaural) and speakers are built-in.

7. Serial digital signals can be received

Serial digital signals can be received and displayed by using the ET-SD06U digital interface unit (sold separately).

This unit is equipped with a power output terminal (6 V DC) for the ET-SD06U, and the unit can be mounted at the rear of the monitor.

8. Suitable for mounting on EIA 19-inch racks

The TY-LK100 rack mounting kit (sold separately) can be used to mount this unit to an EIA 19-inch rack.

Dear Panasonic Customer:

This instruction booklet provides all the necessary information for operating your color video monitor. We hope it will help you to get the most enjoyment out of your new product, and that you will be pleased with your Panasonic color video monitor.

The serial number of your product may be found on its back. You should note the serial number of this unit in the space provided below and retain this booklet as a permanent record of your purchase to aid in identification in the event of theft or loss.

Model number: **BT-S915DA**

Serial number: _____

IMPORTANT SAFETY NOTICE

Read Instructions – All the safety and operating instructions should be read before the appliance is operated.

Retain Instructions – The safety and operating instructions should be retained for future reference.

Head Warnings – All warnings on the appliance and in the operating instructions should be adhered to.

Follow Instructions – All operating and use instructions should be followed.

WARNING: To prevent damage which may result in fire or shock hazard, do not expose this appliance to rain or moisture.

Power Supply: This Color Video Monitor is designed to operate on 120 volts/50/60 Hz, AC house current only.



CAUTION
RISK OF ELECTRIC SHOCK
DO NOT OPEN



CAUTION: TO REDUCE THE RISK OF ELECTRIC SHOCK,
DO NOT REMOVE COVER(OR BACK).
NO USER-SERVICEABLE PARTS INSIDE.
REFER SERVICING TO QUALIFIED SERVICE PERSONNEL.



The lightning flash with arrowhead symbol, within an equilateral triangle, is intended to alert the user to the presence of uninsulated "dangerous voltage" within the product's enclosure that may be of sufficient magnitude to constitute a risk of electric shock to persons.



The exclamation point within an equilateral triangle is intended to alert the user to the presence of important operating and maintenance (servicing) instructions in the literature accompanying the product.

CAUTION: This equipment is equipped with a three-pin grounding-type power plug. Do not remove the grounding pin on the power plug. This plug will only fit a grounding-type power outlet. This is a safety feature. If you are unable to insert the plug into the outlet, contact an electrician. Do not defeat the purpose of the grounding plug.

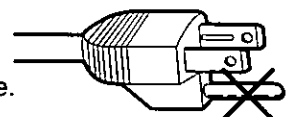

Do not remove

WARNING: This equipment has been tested and found to comply with the limits for a Class A digital device, pursuant to Part 15 of the FCC Rules. These limits are designed to provide reasonable protection against harmful interference when the equipment is operated in a commercial environment. This equipment generates, uses, and can radiate radio frequency energy and, if not installed and used in accordance with the instruction manual, may cause harmful interference to radio communications. Operation of this equipment in a residential area is likely to cause harmful interference in which case the user will be required to correct the interference at his own expense.

CAUTION: Any unauthorized changes or modifications to this equipment would void the users authority to operate.

Precautions

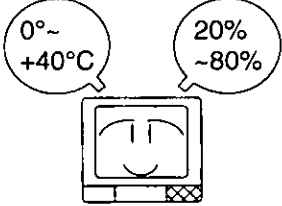
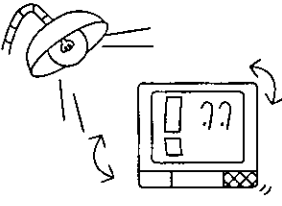
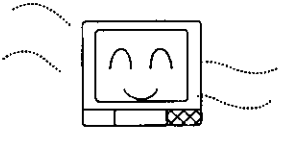
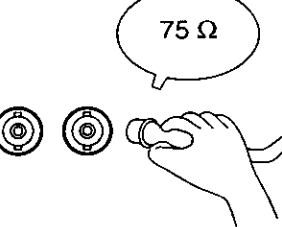
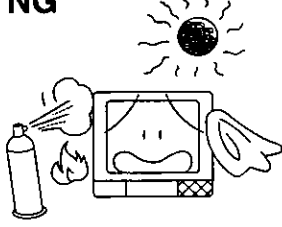
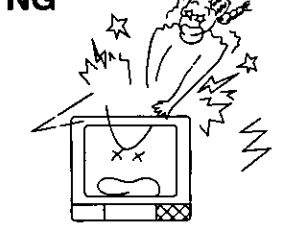
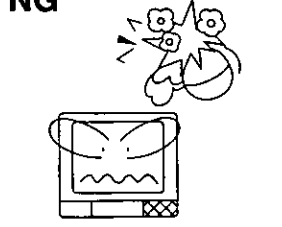
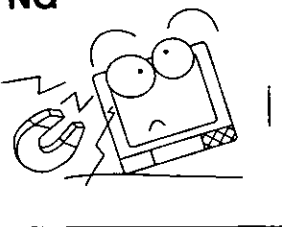
	<p>Do not use or store this monitor beyond its temperature and humidity range.</p> <p>Temperature 0~+40°C (32~104°F) Humidity 20%~80%</p>		<p>Adjust lighting and monitor positions to minimise undesirable reflections.</p>
	<p>The monitor should not be operated within an enclosed or poorly ventilated area. This may cause premature component failure. Do not block the ventilation slots on the side and rear panels.</p>		<p>A 75 Ω coaxial cable must be used and the correct termination provided to assure good picture quality. Cable attenuation should also be considered on long cable runs so that adequate video signal levels can be made available.</p>
<p>NG</p> 	<p>Do not install where there is a risk of flammable gases. Position the monitor to avoid direct sunlight on the picture tube.</p>	<p>NG</p> 	<p>Do not touch electric terminals directly with your fingers. Do not open the cabinet. Refer servicing to qualified personnel only.</p>
<p>NG</p> 	<p>Do not allow liquid to enter the unit. Do not expose terminals and connections to liquids.</p>	<p>NG</p> 	<p>Do not install in a place where the unit will be subjected to mechanical vibration or shock, or magnetic fields. Do not hit or shake this unit when moving it. This may cause damage.</p>

Care and Storage

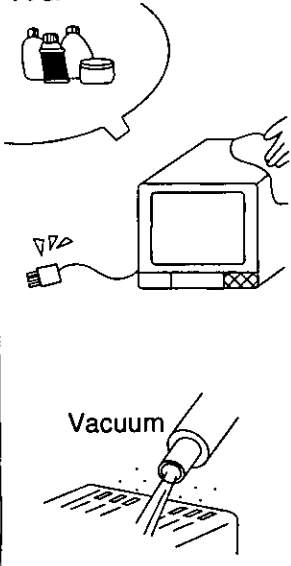
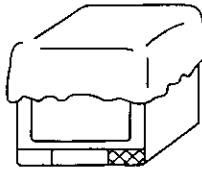
<p>NG</p> 	<p>Care:</p> <p>Wipe with a soft cloth which has been slightly moistened with neutral detergent mixed with water. Do not let the unit come into contact with volatile substances or adhesives.</p> <p>Turn the power switch off while cleaning. Before turning on, the surface of the unit must be dry.</p> <p>Cleaning ventilation slots: When dust has accumulated, use a vacuum cleaner to remove it.</p>		<p>Storage:</p> <p>Disconnect all the connected cables and cords. Cover the unit with a vinyl cover. Do not subject the unit to impacts.</p> <p>Do not subject power or video cables to excessive strain or bending.</p>
--	--	--	---

Operation of Front Panel Controls

Front View

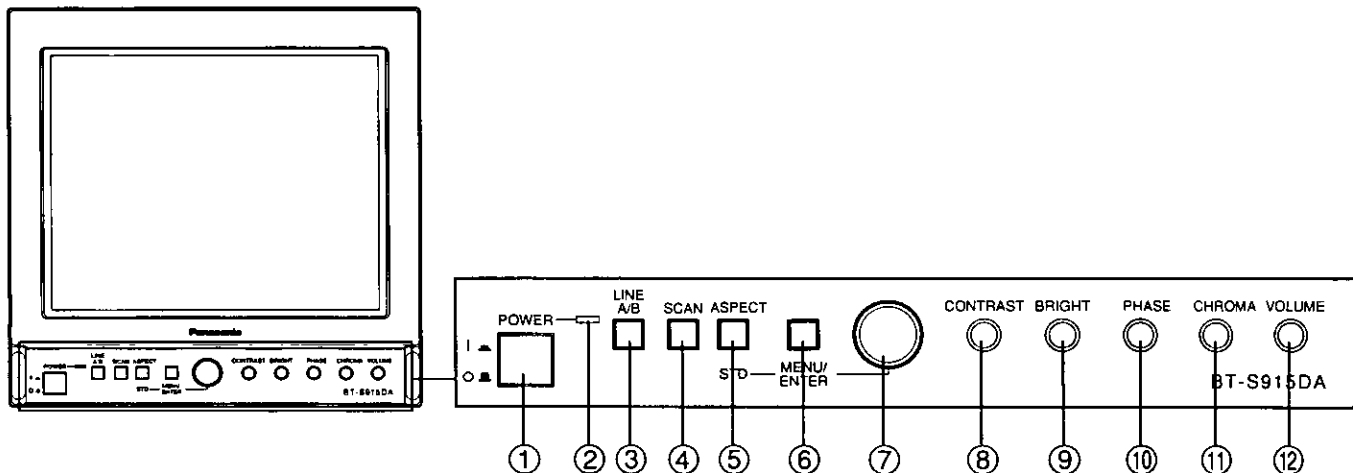

① POWER switch

This switch is used to turn the monitor power on and off.

② Power Indicator

This indicator will light when the power is on.

③ Input Selector Switches

Two signal inputs (LINE A/LINE B) can be selected.

④ Underscan Switch

Press this switch for under-scanning.

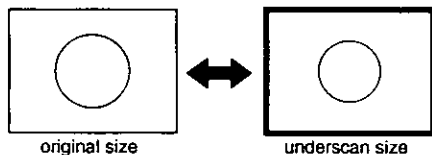

⑤ Aspect/STD Switch

Press this switch to change the aspect ratio to 16:9. To return to the original aspect, press this switch again. (If a menu is being displayed, this switch changes the adjustment value displayed to the factory default setting.)

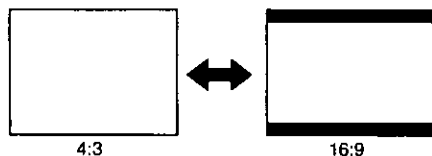

⑥ MENU/ENTER switch

This switch is used to turn the menu screens on and off and to accept a setting.

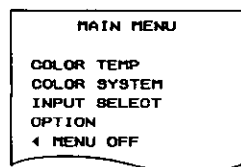

⑦ Rotary switch

This switch is used to move the cursor among items to be selected in a menu screen, and to adjust the picture.

⑧ Contrast Control

Adjust the contrast level for the desired overall contrast.



⑨ Brightness Control

Adjust the brightness level for the desired overall picture or display brightness.



⑩ Phase Control (for NTSC)

Adjust the phase control for the proper color phase or flesh tone tint.



⑪ Chroma Control

Adjust the chroma control to the color saturation level. This function does not operate during RGB input. If the adjustment value is "Min.," color display is forced off so that a black-and-white picture is obtained.



⑫ Volume Control

Adjust the control for the appropriate audio level. If the audio section is not used, turn to the minimum position.



Location of Connectors

Rear View

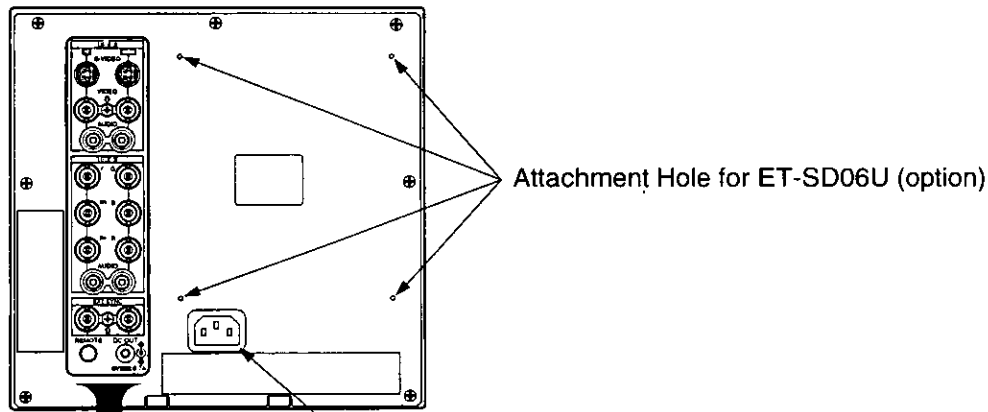

AC Inlet (120V 50/60Hz)
 ※ Connect the AC power cord (Supplied)

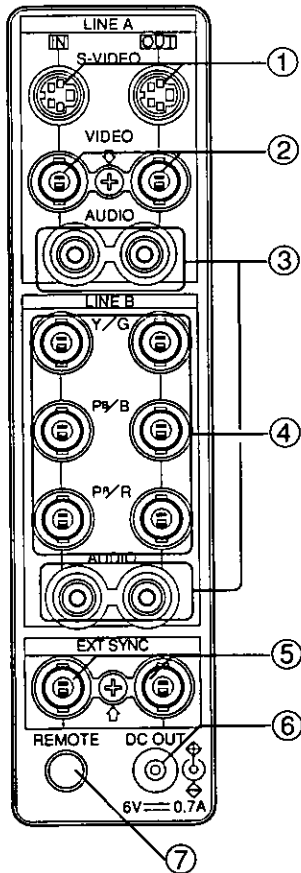

- ① **S-Video Input/Output Terminals (MINI DIN 4-pin)**
 Luminance signal and chroma signal input/output terminals.

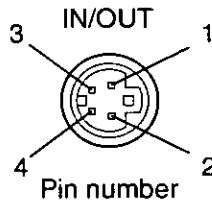

Pin No.	Function
1	Ground (Luminance)
2	Ground (Chroma)
3	Luminance
4	Chroma

- ② **Video Input/Output Connections (BNC)**
 These BNC connectors feature automatic termination. When BNC cables are connected to both the input and output connectors, the 75Ω termination will be automatically opened.
- ③ **Audio Input/Output Connectors (RCA Phono)**
- ④ **RGB/YPbPr Input Connectors (BNC)**
 These terminals are used to input analog RGB signals (primary color signals) or analogue component (YPbPr) signals (color difference signals).
- ⑤ **External Sync Input/Output Connectors (BNC)**
 These connectors are a loop through Input for external sync from RGB or YPbPr signals.
- ⑥ **DC OUT JACK**
 This jack can supply 6 Volts to power the Optional Digital Interface Unit (ET-SD06U).
- ⑦ **REMOTE Jack (M3)**
 The remote control for selecting the aspect ratio plugs in here.

Displaying the COLOR TEMP menu

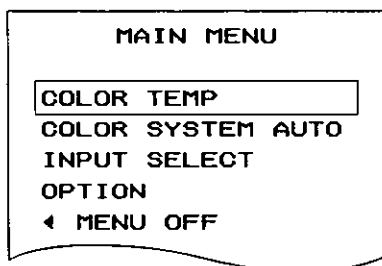
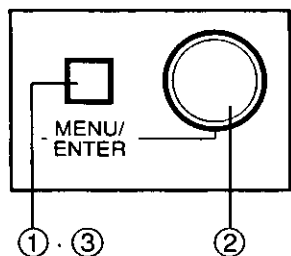

- ① Press to display the MAIN MENU screen.
- ② Turn to select "COLOR TEMP".
- ③ Press to display the COLOR TEMP menu.

NOTE:

- To clear the MAIN MENU screen, turn the rotary switch to select "MENU OFF" and then press the MENU/ENTER switch.

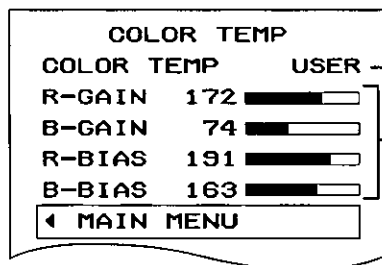

- Standard color temperatures for the picture currently being received
- Adjustment value for user mode color temperature (Cannot be selected when not in user mode)

NOTE:

- To return to the MAIN MENU screen, turn the rotary switch to select "MAIN MENU" and then press the MENU/ENTER switch.

Changing the color temperature

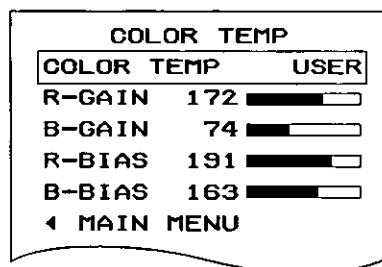
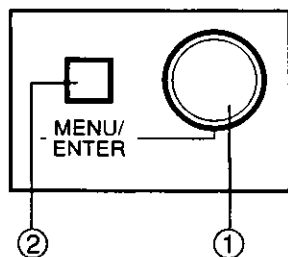

- ① Turn to select "COLOR TEMP".
- ② Press to enter color temperature select mode.

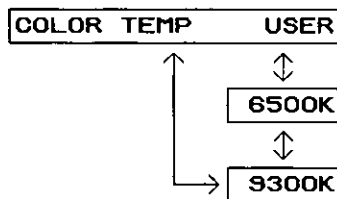
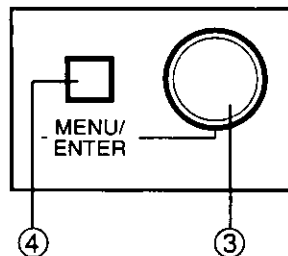

- ③ Turn to select the color temperature.
- ④ Press to accept the setting.

NOTE

- The user mode color temperature is set to "6500K" at the time of shipment from the factory.
- Color temperature settings are stored separately for LINE A and LINE B.

Adjusting the user mode color temperature

Example: Adjusting B-BIAS

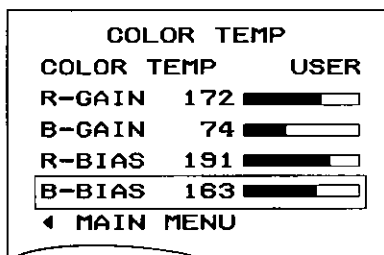
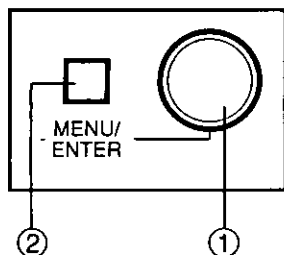

- ① Turn to select "B-BIAS".
- ② Press to enter adjustment mode.

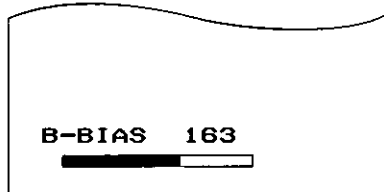
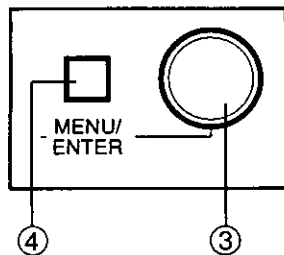

NOTE

- This cannot be selected except when adjusting the user mode color temperature.

- ③ Turn to adjust.



- ④ Press to store the setting.

B-BIAS adjustment mode

NOTE

- If the ASPECT/STD switch is pressed in step ③ after the adjustment has been made (before the MENU/ENTER switch is pressed), the value will return to what it was before adjustment.

DATA UNDO?	YES	NO
------------	-----	----

Returning the adjusted user mode color temperature to the standard setting (factory default setting)

Press the ASPECT/STD switch when the COLOR TEMP menu is displayed.

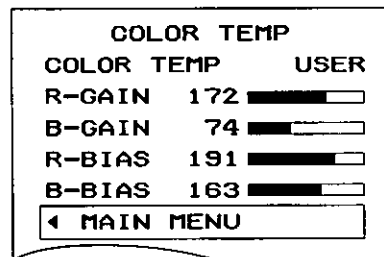
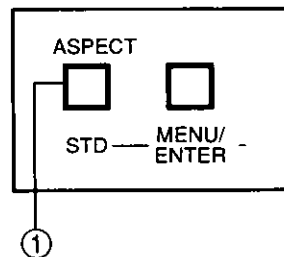

- ① Press the ASPECT/STD switch.

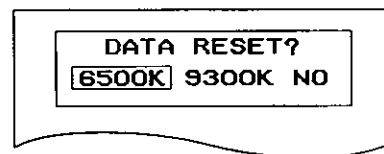
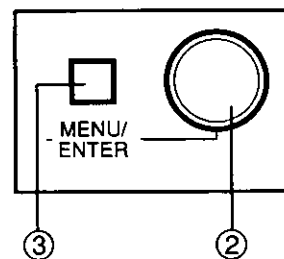

- ② Turn to select "6500K" or "9300K".

- ③ Press to reset.

The user mode color temperature setting will then return to the standard setting.

Displaying the INPUT SELECT menu

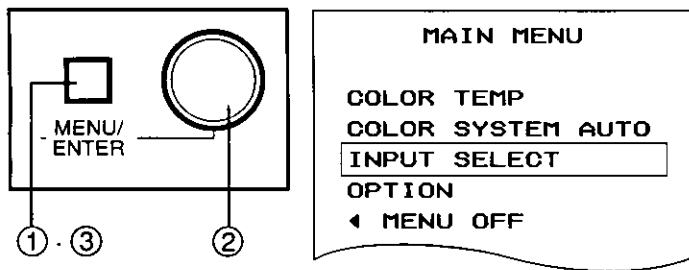

- ① Press to display the MAIN MENU screen.
- ② Turn to select "INPUT SELECT".
- ③ Press to display the INPUT SELECT menu.

NOTE:

- To clear the MAIN MENU screen, turn the rotary switch to select "MENU OFF" and then press the MENU/ENTER switch.

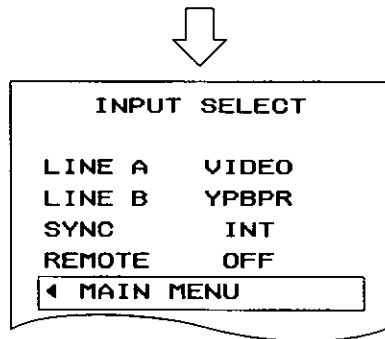

NOTE:

- To return to the MAIN MENU screen, turn the rotary switch to select "MAIN MENU" and then press the MENU/ENTER switch.

Switching to LINE A (Video and S-Video signals)

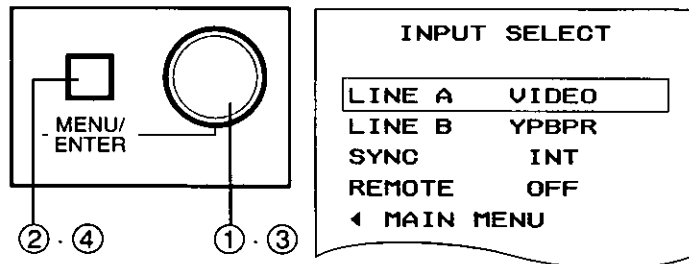

- ① Turn to select "LINE A".
- ② Press to enter selection mode.

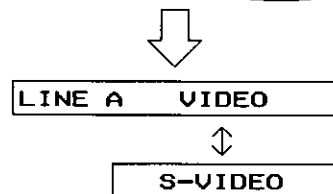

- ③ Turn to select "VIDEO" or "S-VIDEO".
- ④ Press to accept the selection.

Switching to LINE B (RGB and YPBPr signals)

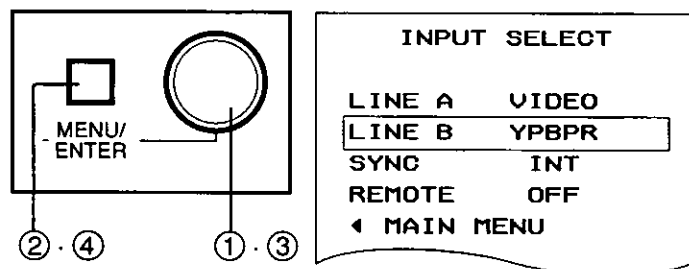

- ① Turn to select "LINE B".
- ② Press to enter selection mode.

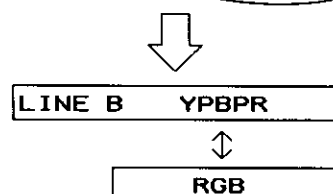

- ③ Turn to select "YPBPr" or "RGB".
- ④ Press to accept the selection.

Selecting the synchronization method (external or internal synchronization)

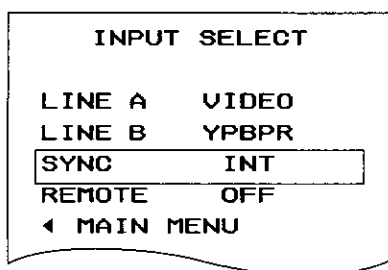
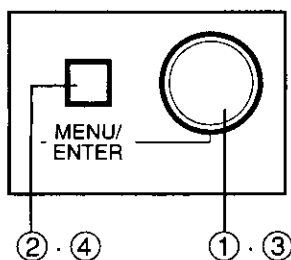

- ① Turn to select "SYNC".
- ② Press to enter selection mode.

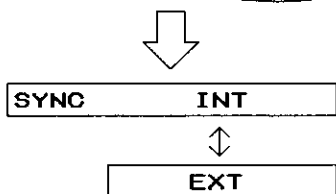

- ③ Turn to select "INT" (internal) or "EXT" (external).
- ④ Press to accept the selection.

Turning remote operation on and off

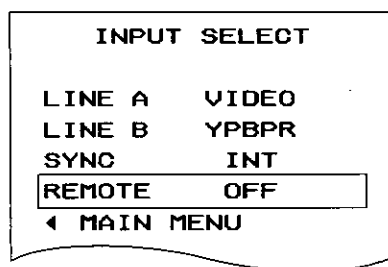
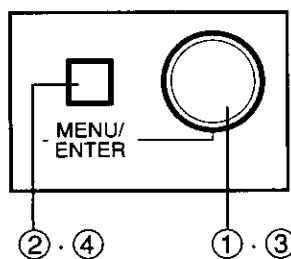

- ① Turn to select "REMOTE".
- ② Press to enter selection mode.

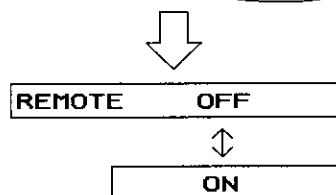

- ③ Turn to select "OFF" or "ON".
- ④ Press to accept the selection.

"OFF" ... The aspect can be changed using the ASPECT/STD switch at the front of the set.
 "ON" ... The aspect can be changed using the external switch connected to the REMOTE Jack at the back of the set.

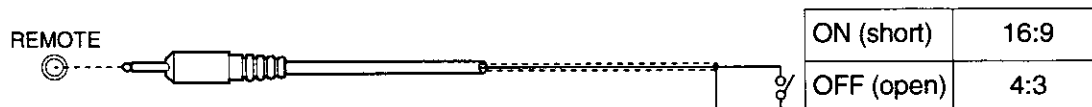

NOTE

- When set to "ON", the ASPECT switch at the front of the set will not function.

Displaying the OPTION menu

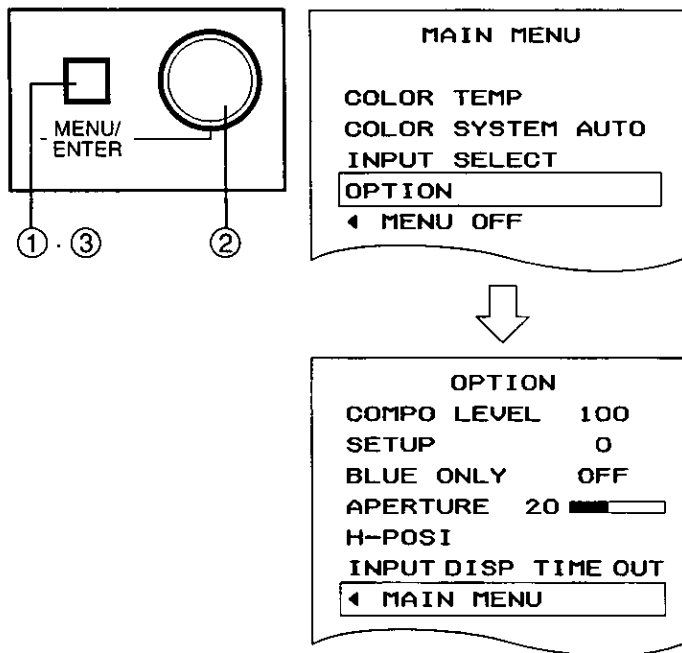

- ① Press to display the MAIN MENU screen.
- ② Turn to select "OPTION".
- ③ Press to display the OPTION menu.

NOTE:

- To clear the MAIN MENU screen, turn the rotary switch to select "MENU OFF" and then press the MENU/ENTER switch.

NOTE:

- To return to the MAIN MENU screen, turn the rotary switch to select "MAIN MENU" and then press the MENU/ENTER switch.

Changing the component level

The component level can be changed when LINE B (YP_BPR) is selected.

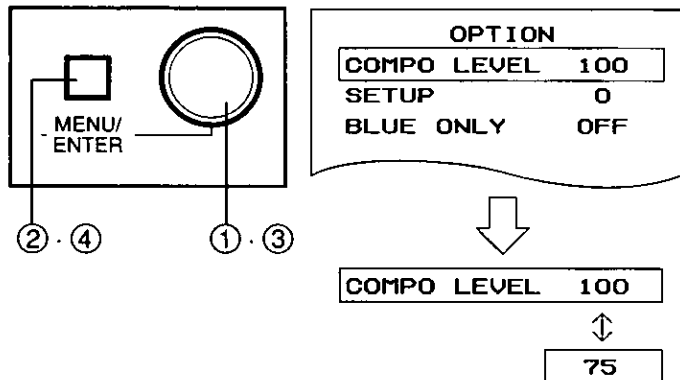

- ① Turn to select "COMPO LEVEL".
- ② Press to enter selection mode.

- ③ Turn to select "100" or "75".
- ④ Press to accept the selection.

- 100: Y, P_B, P_R for use with 100% color bar standard system
 75: Y, P_B, P_R for use with 75% color bar standard system

Changing the setup level

The setup level can be changed when LINE A (NTSC) or LINE B (YP_BPR) is selected.

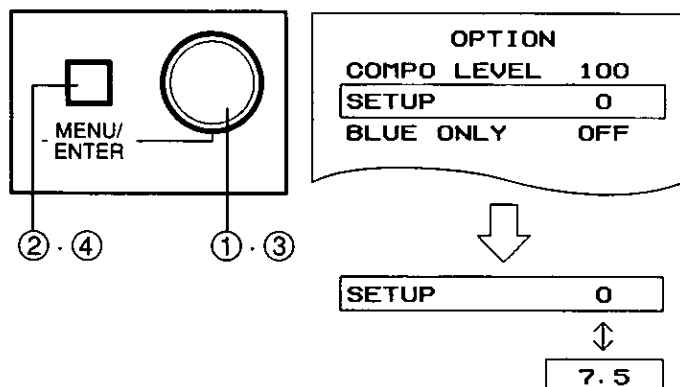

- ① Turn to select "SETUP".
- ② Press to enter selection mode.

- ③ Turn to select "0" or "7.5".
 - ④ Press to accept the selection.
- 0: For video signal without set-up level
 7.5: For video signal with set-up level (7.5%)

BLUE ONLY mode

Blue only mode is used to adjust the chrominance and phase when the color bars are displayed.

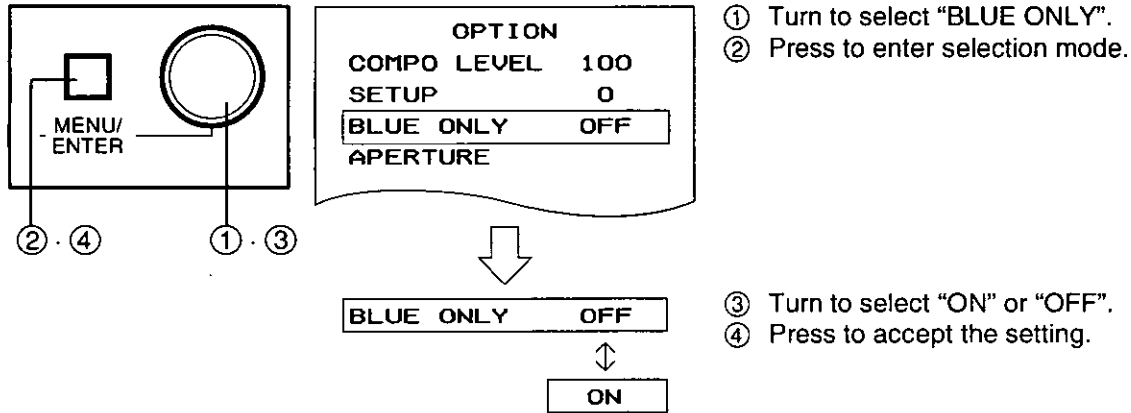

NOTE

- This cannot be changed when LINE B (RGB) is selected.

<Setting the chrominance and phase when using BLUE ONLY mode>

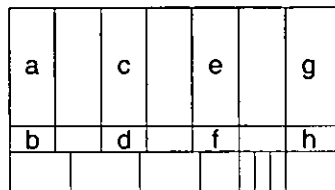

SMPTE color bar pattern

1. Input a SMPTE color bar signal as shown at left, and then follow the procedure above to set BLUE ONLY mode.
2. Use the phase VR to adjust so that c, d, e and f are at the same level.
3. Use the chroma VR to adjust so that a, b, g and h are at the same level.
4. Repeat steps 2 and 3 until a, b, c, d, e, f, g and h are at the same level.
5. The chroma and phase will be set once you exit BLUE ONLY mode.

Adjusting the aperture

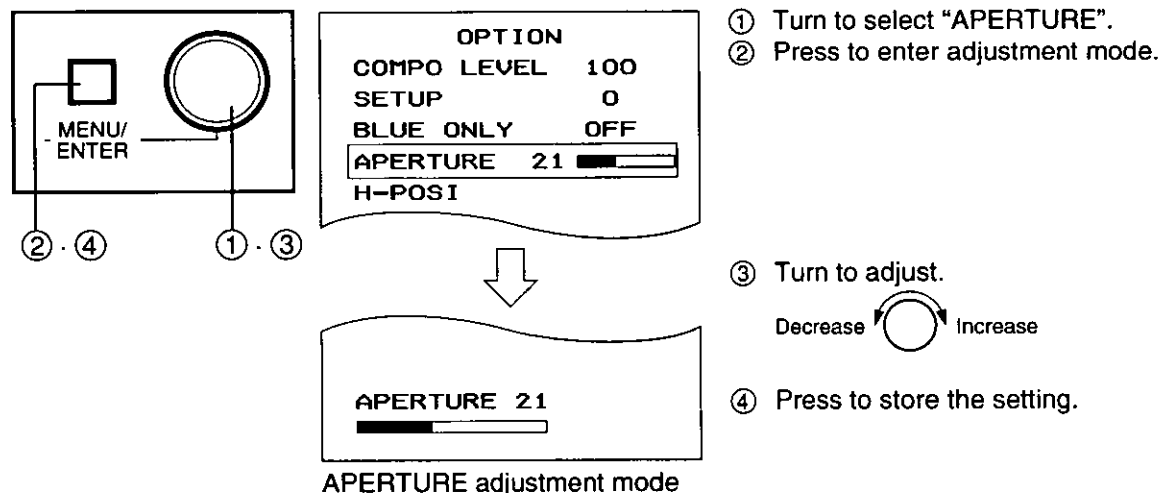

NOTE

- Aperture adjustment values are stored separately for LINE A and LINE B.

Returning APERTURE adjustment values to standard settings (factory, default settings)

Press the ASPECT/STD switch after entering APERTURE adjustment mode.

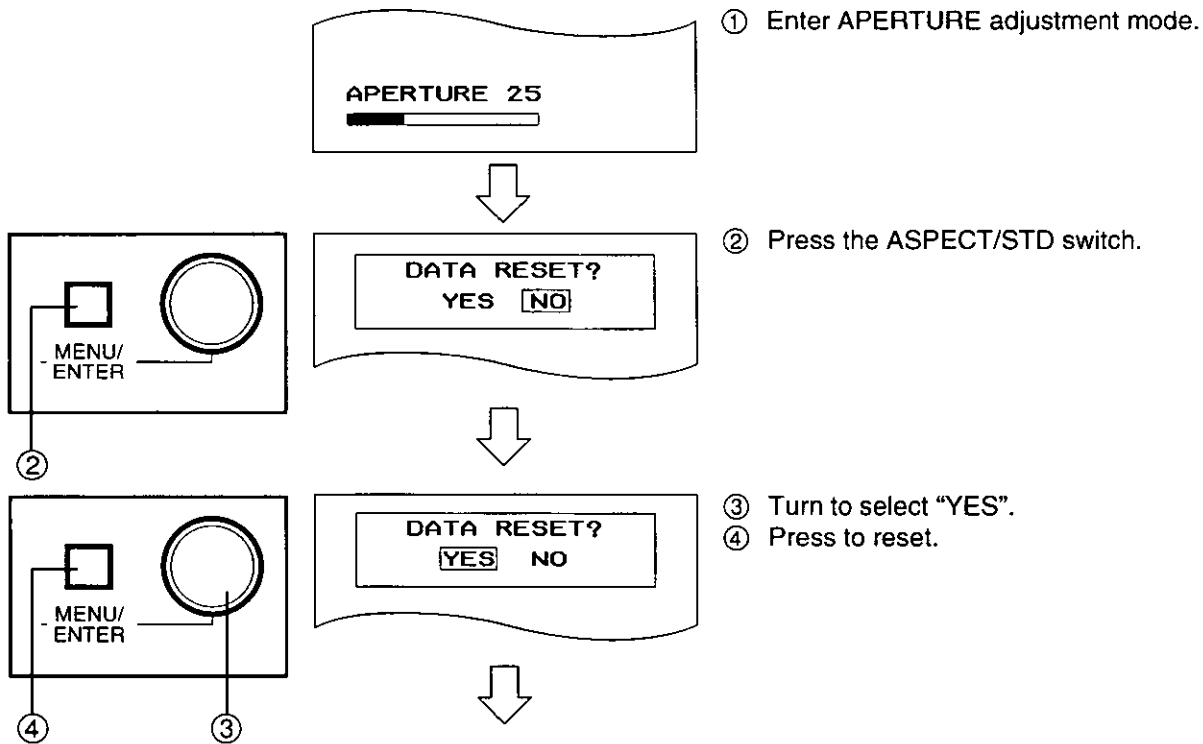

The APERTURE setting value will then return to the factory default setting, and the OPTION MENU screen will be displayed.

Adjusting the horizontal position

The horizontal picture position can be changed when LINE B (RGB) is selected.

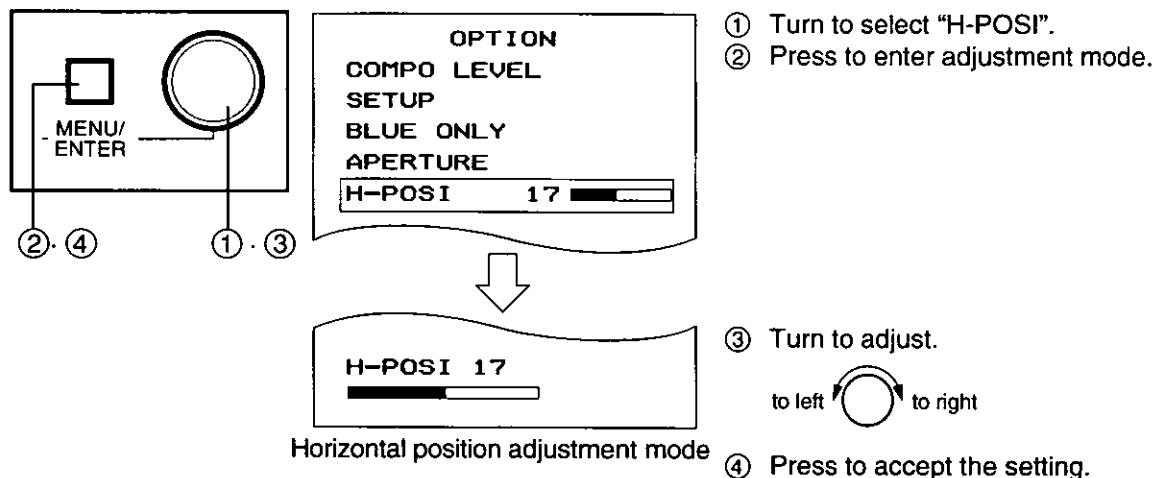

The horizontal position value can be returned to the factory default setting by following the same procedure as for the aperture setting given above.

Selecting the input display

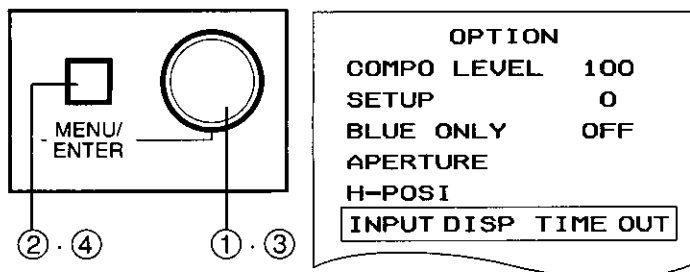

- ① Turn to select "INPUT DISP".
- ② Press to enter selection mode.

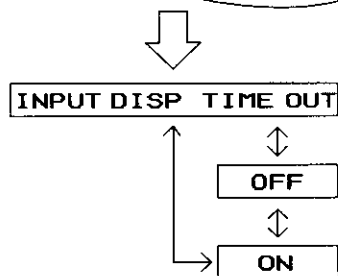

- ③ Turn to select "TIME OUT", "OFF" or "ON".
 "TIME OUT"... When the input source is changed, the source is displayed for a few seconds and then disappears automatically.
 "OFF" Not displayed
 "ON" Always displayed

- ④ Press to accept the setting.

Selecting the color system format

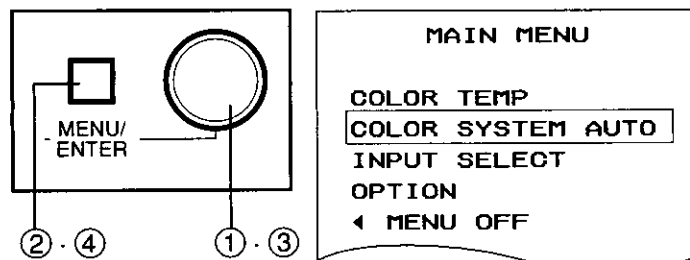

- ① Press to display the MAIN MENU screen.
- ② Turn to select "COLOR SYSTEM".
- ③ Press to enter selection mode.

NOTE

- This can only be selected for LINE A input.

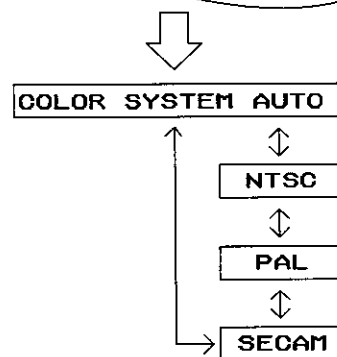

- ④ Turn to select the format.
 - ⑤ Press to accept the selection.
- This should be set to "AUTO" for normal use.

NOTE

- When "AUTO" is set, the format will be detected automatically if the input signal is in either NTSC, PAL or SECAM format.
- If there is a lot of noise in the input signal or if the signal level is low, the picture may not be stable if "AUTO" is selected. If this happens, select the appropriate format for the signal manually.
- To clear the MAIN MENU screen, turn the rotary switch to select "MENU OFF" and then press the MENU/ENTER switch.

Specifications

- Power Source: 120V AC, 50/60Hz
- Max Amps: 0.85A
- Picture Tube: 9" diagonal, 90° deflection, in-line gun, Dot pitch 0.50 mm
- Effective screen size: 175 (W) × 137(H) mm (min.)
- Horizontal resolution: typical 300TV lines
- Color temperature: 6500k / 9300k / USER selectable
- Color System: NTSC / PAL / SECAM
- Audio Power output: 1W (10% THD)
- Speaker: Round (6.6cm) × 1, 16Ω
- Input/Output Connectors:
 - LINE A (IN/OUT) ○VIDEO (BNC)
1Vp-p (75Ω or High-impedance Auto)
 - S-VIDEO (Mini Din 4pin)
Y: 1Vp-p (75Ω or High-impedance Auto)
C: 0.286Vp-p (75Ω or High-impedance Auto)
 - AUDIO (RCA phono)
0.5Vrms (more than 22kΩ)
 - LINE B (IN/OUT) ○Y, P_B, P_R (BNC)
Y: 1Vp-p (75Ω or High-impedance Auto)
P_B, P_R: ±0.35V
 - G B R (BNC)
G,B,R: 0.7Vp-p (75Ω or High-impedance Auto)
 - G on sync 1Vp-p (75Ω or High-impedance Auto)
 - AUDIO (RCA phono)
0.5Vrms (more than 22kΩ)
 - EXT SYNC (IN/OUT) Composite Sync (BNC)
0.3 - 4.0 Vp-p (75Ω, or High-impedance Auto)
 - REMOTE M3 Jack
 - DC OUT DC 6V, 0.7A OUT for ET-SD06U
- Dimensions (W × D × H): 8²⁵/₃₂" × 12⁵⁹/₆₄" × 9⁵/₃₂"
(223mm × 328mm × 229mm)
- Weight: 15.9lbs. (7.2kg)
- Operating Temperature: 32 – 104°F (0 – 40°C)
- Operating Humidity: 20 – 80%
- Accessory: AC power cord
- Options: Rack fitting kit (TY-LK100)
(Serial) Digital Interface unit (ET-SD06U)

Panasonic

PANASONIC BROADCAST & TELEVISION SYSTEMS COMPANY
DIVISION OF MATSUSHITA ELECTRIC CORPORATION OF AMERICA

Executive Office:

3330 Cahuenga Blvd W., Los Angeles, CA 90068 (323) 436-3500

EASTERN ZONE:

One Panasonic Way 4E-7, Secaucus, NJ 07094 (201) 348-7621

Southeast Region:

1225 Northbrook Parkway, Ste 1-160, Suwanee, GA 30024 (770) 338-6835

Central Region:

1707 N Randall Road E1-C-1, Elgin, IL 60123 (847) 468-5200

WESTERN ZONE:

3330 Cahuenga Blvd W., Los Angeles, CA 90068 (323) 436-3500

Government Marketing Department:

52 West Gude Drive, Rockville, MD 20850 (301) 738-3840

Broadcast PARTS INFORMATION & ORDERING:

9:00 a.m. – 5:00 p.m. (EST) (800) 334-4881/24 Hr. Fax (800) 334-4880

Emergency after hour parts orders (800) 334-4881

TECHNICAL SUPPORT:

Emergency 24 Hour Service (800) 222-0741

Panasonic Canada Inc.

5770 Ambler Drive, Mississauga, Ontario L4W 2T3 (905) 624-5010

Panasonic de Mexico S.A. de C.V.

Av angel Urraza Num. 1209 Col. de Valle 03100 Mexico, D.F. (52) 1 951 2127

Panasonic Sales Company

Division of Matsushita Electric of Puerto Rico Inc.

San Gabriel Industrial Park, 65th Infantry Ave., Km. 9.5, Carolina, Puerto Rico 00630 (787) 750-4300

Printed in Japan

SI0399-1011B 



Free Manuals Download Website

<http://myh66.com>

<http://usermanuals.us>

<http://www.somanuals.com>

<http://www.4manuals.cc>

<http://www.manual-lib.com>

<http://www.404manual.com>

<http://www.luxmanual.com>

<http://aubethermostatmanual.com>

Golf course search by state

<http://golfingnear.com>

Email search by domain

<http://emailbydomain.com>

Auto manuals search

<http://auto.somanuals.com>

TV manuals search

<http://tv.somanuals.com>