

Panasonic

Operating Instructions

Global VoIP Telephone

Model No. **BB-GT1500E**

BB-GT1520E

BB-GT1522E

BB-GT1540E

Powered by
deltathree, Inc.

joip™

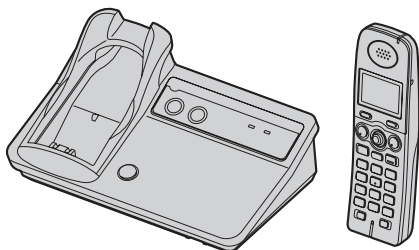

BB-GT1500E



This unit is compatible with Caller ID. To use this feature, you must subscribe to the joip service offered by deltathree, Inc. or the appropriate service offered by your landline service provider.

Charge the handset battery for 7 hours before initial use.

Please read these Operating Instructions before using the unit and save for future reference.

Introduction

Product information	3
Accessory information	7
Symbols used in these operating instructions	10

Important Information

Important information	11
Security caution	12

Preparation

Controls (Base unit)	14
Controls (Handset)	17
Installation	18
Battery charge	21
Understanding the indicators on the base unit	23
Displays	26
Setting the unit before use	29

Making/Answering Calls (Handset)

Making calls	32
Answering calls	33
Useful features during a call	33

Making/Answering Calls (Base Unit)

Making calls	36
Answering calls	36
Useful features during a call	37

Making Internet Calls (Mobile Phone)

Making internet calls using your mobile phone	39
---	----

Handset Phonebook

Handset phonebook	40
-----------------------------	----

Base Unit Speed Dialler

Base unit speed dialler	43
-----------------------------------	----

Caller ID Service

Using Caller ID service	44
Caller list	45

Programming

Programmable settings	47
---------------------------------	----

Answering System

Answering system	60
Greeting message	61
Listening to messages using the base unit	61
Listening to messages using the handset	62
Voice memo	63
Remote operation	64
Answering system settings	66

Voice Mail Service

Using Voice Mail service	68
------------------------------------	----

Intercom Features

Intercom features between handsets	69
Intercom features between the handset and base unit	70

joip Service

Using joip service features	73
---------------------------------------	----

Useful Information

Belt clip	76
Wall mounting for charger	76
Registering a handset	77
IP RESET button	78
Character entry	79
Error messages	81
Troubleshooting	84
Open Source Software	92
Specifications	102
Conditions of guarantee	103
Customer services	104

Index

Index	107
-----------------	-----

Product information

Thank you for purchasing a Panasonic GLOBARANGE phone.

These operating instructions can be used for the following models:

BB-GT1500

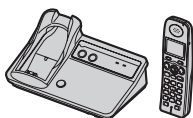

BB-GT1520

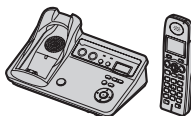

BB-GT1522







BB-GT1540



Important:

- The suffix (E) in the following model numbers will be omitted in these instructions:
BB-GT1500E/BB-GT1520E/BB-GT1522E/BB-GT1540E

Notable feature differences between models

Model no.	Answering system	Intercom		Make/answer calls with base unit
		 ↔  *1	 ↔  *2	
BB-GT1500	—	—	●*3	—
BB-GT1520	●	●	●*3	—
BB-GT1522	●	●	●	—
BB-GT1540	●	●	●*3	●

*1 Intercom calls can be made between the handset and base unit.

*2 Intercom calls can be made between the handsets.

*3 Intercom calls can be made between the handsets by purchasing and registering 1 or more optional handsets (BB-GTA150E, page 9).

How the GLOBARANGE phone works

Connect this phone to both a landline and the Internet (IP line) so you can make or receive internet calls as well as landline calls.

When you make calls with joip, a VoIP (Voice over Internet Protocol) service, your voice will be sent as data packets over the Internet to the person you are calling

Introduction

converted into voice. Basically, you can make internet calls using the joip service virtually the same as using a landline. For more information, see "What is joip/joip number?" below and visit www.joip.com

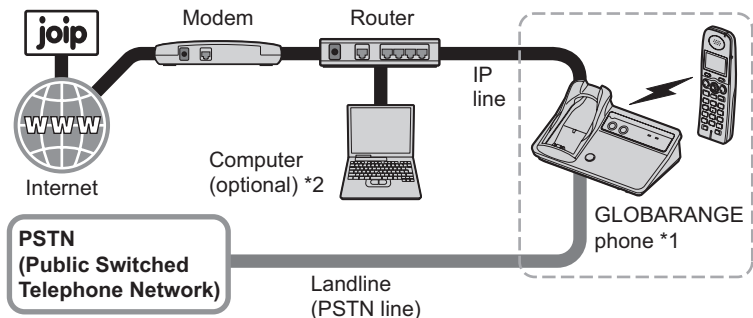

*1 Model shown is BB-GT1500.

*2 Computer is not required for setup or making/answering internet calls.

What is joip/joip number?

joip is the VoIP service provided by deltathree Inc. After connecting this phone to the Internet (page 18, 30), a unique joip number is sent to your handset display (page 31), so you can use your IP line as follows:

1. Make and receive free calls to and from other joip numbers for a full period of 3 years from the date of setup.^{*1*2}
2. Make calls from your joip number to landline and mobile phones at very low rates by subscribing to the appropriate service at www.joip.com
3. Receive calls from landline and mobile phone numbers via your IP line by subscribing for additional phone number(s) at www.joip.com

These additional phone numbers can be chosen regardless of your geographic location from a list of international and local area codes offered by joip. There may be restrictions in obtaining phone numbers from certain countries or areas. Visit www.joip.com for details.

A joip number consists of a # followed by 10 digits, enabling you to make and receive free calls to and from other joip number owners for a full period of 3 years from the date of setup.^{*1*2}

The joip number does not involve extra charges and is given free to Panasonic GLOBARANGE phone owners.

*1 Requires both parties to have a Panasonic GLOBARANGE Phone, activated the joip service from deltathree, Inc., and broadband internet service provided by a cable company or internet service provider for a fee.

*2 After 3 years, the joip service may require a fee.

Important:

For joip services, please visit the joip website: www.joip.com or contact the joip service provider.

- Terms of Use for the joip services are available on the supplied leaflet or at www.joip.com and must be read and accepted prior to using joip services.
- NEITHER PANASONIC COMMUNICATIONS CO., LTD., PANASONIC SALES COMPANIES NOR PANASONIC SALES AGENCIES IS IN ANY WAY AFFILIATED WITH, OR RESPONSIBLE FOR THE ACTS OR OMISSIONS OF, DELTATHREE, INC. NEITHER PANASONIC COMMUNICATIONS CO., LTD., PANASONIC SALES COMPANIES, PANASONIC SALES AGENCIES NOR ANY OF THEIR EMPLOYEES OR AFFILIATES OR CUSTOMERS MAKE ANY WARRANTIES OR REPRESENTATIONS, EITHER EXPRESS OR IMPLIED, TO ANY CUSTOMER OR ANY OTHER THIRD PARTY WITH RESPECT TO ANY OF THE SERVICES PROVIDED BY DELTATHREE, INC., NOR ASSUME NOR CREATE ANY OTHER OBLIGATION OF ANY KIND ON BEHALF OF DELTATHREE, INC.
- In the event that your unit requires service within or outside of the Limited Warranty, Panasonic will not be responsible for any loss of ringtones or other information previously downloaded, including the cost to repurchase such ringtones or other information.

For emergency calls, use the landline.

- Even if you select the IP line, the landline is automatically used when dialling emergency phone numbers.

Note:

- We recommend installing only one Panasonic GLOBARANGE phone base unit. If you install more than one Panasonic GLOBARANGE phone base unit, you may not be able to make or receive internet calls properly.
- Sound quality and overall performance of IP phone may vary depending on the condition of your network connection. Refer to "Troubleshooting", page 89.

Trademarks

- deltatree and joip are either registered trademarks or trademarks of deltatree, Inc., in the United States and/or other countries.
- All other trademarks identified herein are the property of their respective owners.

Feature highlights

- **Free calls to other joip service subscribers (Panasonic GLOBARANGE phone owners) for a full period of 3 years from the date of setup**^{*1}
- **High quality IP telephony using your Internet connection**
Enjoy high-quality calls at low rates to any destination worldwide using the joip service.
- **Standard phone using a landline**
- **Expandable phone system (up to 6 total handsets)**^{*2}
Allows you to make an internet call on one handset while another handset is talking on the landline.
- **Save 100 phonebook items on a handset**
- **Phonebook/Ringtone data downloading**
Easily edit the phonebook items from a computer using the joip website (www.joip.com). Download phonebook items and ringtones to the base unit, then import them to a handset.
- **Internet call ability using a mobile phone via the unit's answering system (BB-GT1520/BB-GT1522/BB-GT1540)**^{*3}

*1 After 3 years, the joip service may require a fee.

*2 Requires optional additional handsets (sold separately, page 9).

*3 Requires subscription for additional phone number(s) for your joip IP line other than the joip number (page 4).

Note:

- joip, a service powered by deltathree, Inc., offers special features such as Caller ID, Call Waiting, and Voice Mail. For more information, visit the joip website (www.joip.com).
- Your landline service provider may offer special telephone services such as Caller ID, Call Waiting, and Voice Mail. Please contact your landline service provider for details and availability in your area.

System requirements

Your network must meet the following technical specifications for the unit to work as an IP phone.

Item	Description
Internet connection	Broadband Internet connection such as DSL or cable
Modem	Broadband modem with Ethernet port (USB-only modems are not supported.)
Router	Broadband router ^{*1*2}

*1 This unit is not compatible with the following:

- PPPoE (Point to Point Protocol over Ethernet)
- PPTP (Point-to-Point Tunneling Protocol)
- L2TP (Layer 2 Tunneling Protocol)

If your Internet service provider uses a PPPoE, PPTP, or L2TP connection, a compatible router is required.

*2 This unit is designed to obtain an IP address automatically from a DHCP (Dynamic Host Configuration Protocol) server. We recommend using the DHCP server (page 30).

Accessory information

Supplied accessories

No.	Accessory item	Order number	Quantity	
			BB-GT1500/ BB-GT1520/ BB-GT1540	BB-GT1522
①	AC adaptor for base unit	PQLV203EZ (PQLV203E)	1	1
②	Telephone line cord	PQJA87S (for UK)	1	1
③	Battery	HHR-P107	1	2
④	Handset cover ^{*1}	PQYNGTA150BR	1	2
⑤	Ethernet cable (Category 5E straight cable)	PQJA10181Z	1	1
⑥	Belt clip	PQKE10478Z2	1	2
⑦	Charger	PQLV30054N	–	1

Introduction

No.	Accessory item	Order number	Quantity	
			BB-GT1500/ BB-GT1520/ BB-GT1540	BB-GT1522
⑧	AC adaptor for charger	PQLV208EZ (PQLV208E)	–	1

*1 The handset cover comes attached to the handset.

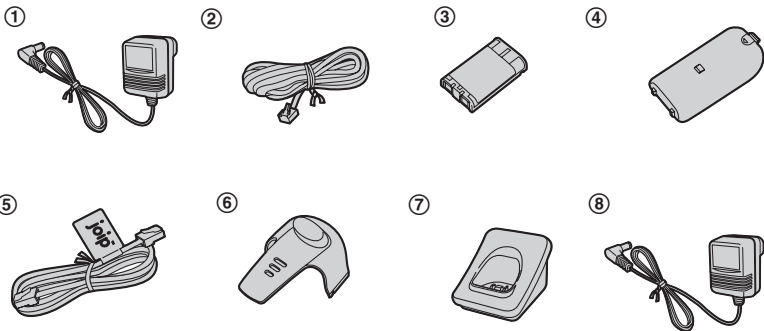

Additional/replacement accessories

Please contact your nearest Panasonic dealer for sales information.

No.	Accessory item	Order number
①	Rechargeable nickel metal hydride (Ni-MH) battery	HHR-P107
②	Additional handset with charger	BB-GTA150E
③	Headset	KX-TCA94EX
④	Wall mounting adaptor for base unit	PQZMGT1500

③



④



Expanding your phone system





You can expand the phone system by registering optional handsets to a single base unit.

- A maximum of 6 total handsets (supplied and optional) can be registered to a single base unit.

Handset (optional): BB-GTA150E



Symbols used in these operating instructions

Symbol	Meaning
	Features and operations for using the IP line
	Features and operations for using the landline
	Perform with the handset.
	Perform with the base unit.
[]	The words in the brackets indicate button names on the handset and base unit.
→	Proceed to the next operation.
“ ”	The words in quotations indicate the menu on the display. Example: “Ringer ID”
[▼]/[▲]: “ ”	Push the handset joystick down or up to select the words in quotations. Example: [▼]/[▲]: “OFF”
[^]/[v]/[◀]/[▶] (BB-GT1520/ BB-GT1522/ BB-GT1540)	Press up, down, left, or right on the base unit navigator key.
[▶] (BB-GT1520/ BB-GT1522/ BB-GT1540)	Press the centre of the base unit navigator key.

Important information

General

- Use only the AC adaptor supplied with this product, noted on page 7.
- Do not connect the AC adaptor to any AC outlet other than a standard 220–240 V AC outlet.
- Do not open the base unit, charger, or handset other than to replace the battery(ies).
- This product should not be used near emergency/intensive care medical equipment and should not be used by people with pacemakers.
- Care should be taken that objects do not fall onto, and liquids are not spilled into, the product. Do not subject this product to excessive smoke, dust, mechanical vibration or shock.

Environment

- Do not use this product near water.
- This product should be kept away from heat sources such as radiators, cookers, etc. It should also not be placed in rooms where the temperature is less than 5 °C or greater than 40 °C.
- The AC adaptor is used as the main disconnect device. Ensure that the AC outlet is installed near the product and is easily accessible.

Warning:

- To prevent the risk of electrical shock, do not expose this product to rain or any other type of moisture.
- Unplug this product from power outlets if it emits smoke, an abnormal smell, or makes unusual noise. These conditions can cause fire or electric shock. Confirm that smoke has

stopped emitting and contact an authorised service centre.

- Do not spill liquids (detergents, cleansers, etc.) onto the telephone line cord plug, or allow it to become wet at all. This may cause a fire. If the telephone line cord plug becomes wet, immediately pull it from the telephone wall jack, and do not use.
- Do not place or use this product near automatically controlled devices such as automatic doors and fire alarms. Radio waves emitted from this product may cause such devices to malfunction resulting in an accident.
- Regularly remove any dust, etc. from the AC adaptor/power plug by pulling it from the power outlet, then wiping with a dry cloth. Accumulated dust may cause an insulation defect from moisture, etc. resulting in a fire.
- Do not damage the power cord/plug. This may cause a short circuit, electric shock, and/or fire.
- Do not touch the plug with wet hands.

Battery caution

- We recommend using the battery(ies) noted on page 9. **Use only rechargeable battery(ies).**
- Do not dispose of the battery(ies) in a fire, as they may explode. Check with local waste management codes for special disposal instructions.
- Do not open or mutilate the battery(ies). Released electrolyte from the battery(ies) is corrosive and may cause burns or injury to the eyes or skin. The electrolyte may be toxic if swallowed.
- Exercise care when handling the battery(ies). Do not allow conductive materials such as rings, bracelets or keys to touch the battery(ies), otherwise a short circuit may cause

Important Information

the battery(ies) and/or the conductive material to overheat and cause burns.

- Charge the battery(ies) in accordance with the information provided in these operating instructions.
- Only use the supplied base unit (or charger) to charge the battery(ies). Do not tamper with the base unit (or charger). Failure to follow these instructions may cause the battery(ies) to swell or explode.

No responsibility will be taken by our company with respect to consequences resulting from the inappropriate use, damage or both of the unit.

Information on Disposal for Users of Waste Electrical & Electronic Equipment (private households)



This symbol on the products and/or accompanying documents means that used electrical and electronic products should not be mixed with general household waste. For proper treatment, recovery and recycling, please take these products to designated collection points, where they will be accepted on a free of charge basis. Alternatively, in some countries you may be able to return your products to your local retailer upon the purchase of an equivalent new product.

Disposing of this product correctly will help to save valuable resources and prevent any potential negative effects on human health and the environment which could otherwise arise from inappropriate waste handling. Please contact your local authority for further

details of your nearest designated collection point.

Penalties may be applicable for incorrect disposal of this waste, in accordance with national legislation.

For business users in the European Union

If you wish to discard electrical and electronic equipment, please contact your dealer or supplier for further information.

Information on Disposal in other Countries outside the European Union

This symbol is only valid in the European Union.

If you wish to discard this product, please contact your local authorities or dealer and ask for the correct method of disposal.

Security caution

When using this product, take appropriate measures to avoid the following security breaches:

- Leaks of private information via this product
- Illegal use of this product by a third party
- Interference or suspension of the use of this product by a third party

Take the following measures to avoid security breaches:

- To prevent illegal access, keep the base unit software updated (if you do not have the latest version of software, this can lead to blocked access or information leaks) (page 57).

- You are responsible for the security settings, such as the remote code for the answering system, to access this product. This information should not be made available to any third parties outside the user group. To prevent unauthorised access to this product, we recommend that you regularly change the remote code (page 64).
- Place this product where it is unlikely to be stolen.
- During an internet call, outside interference may occur resulting in improper call transmission and/or unit function.

Notice for product disposal, transfer, or return

- This product can store your private/confidential information. To protect your privacy/confidentiality, we recommend that you erase the information such as phonebook or caller list entries from the memory before you dispose, transfer or return the product.
 - Erasing caller list information (page 46)
 - Erasing phonebook information (page 41)
 - Erasing messages (page 62, 74)
- When transferring this product to another party or disposing of this product, be sure to cancel the service contract with joip at www.joip.com if you subscribed to optional joip services.

Routine care



- **To clean the product, use a dry soft cloth. The outer surface of the product can be scratched by wiping or rubbing with a hard cloth.**
- Do not use benzine, thinner, or any abrasive powder.

Controls (Base unit)

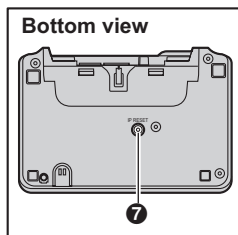
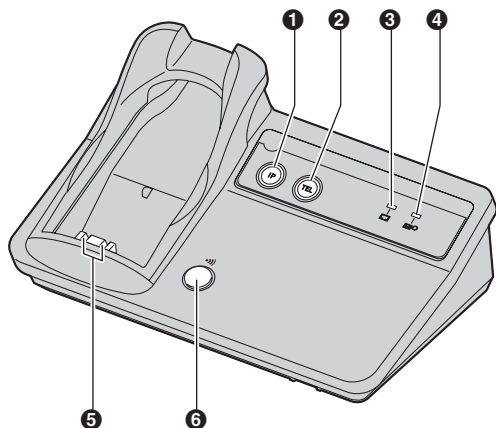
BB-GT1500



- ❶ IP indicator
- ❷ TEL indicator
- ❸  (Status) indicator
- ❹  (Voice Mail) indicator
- ❺ Charge contacts
- ❻  (Page)^{*1}
- ❼  [IP RESET]

*1 You can locate a misplaced handset by pressing . To stop paging, press it again or  on the handset.

BB-GT1520/BB-GT1522

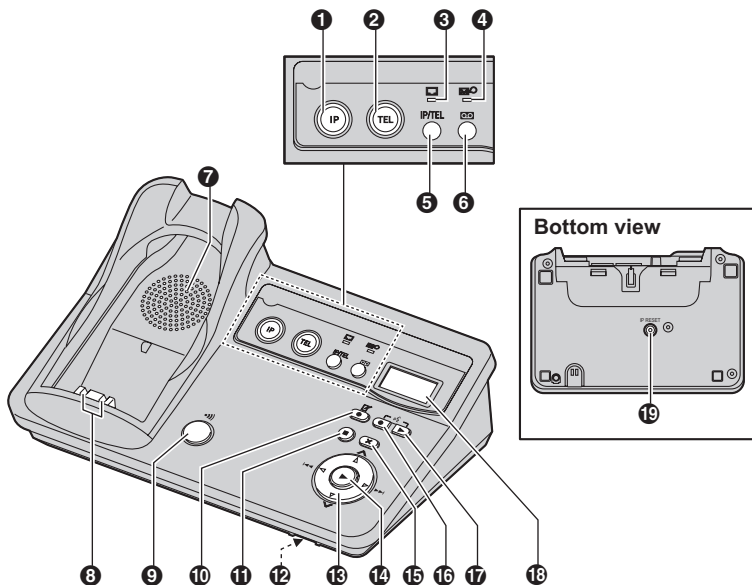

- ❶ IP indicator
- ❷ TEL indicator
- ❸ (Status) indicator
- ❹ (Voice Mail) indicator
- ❺ [IP/TEL]
- ❻ (Answer on)/Answer on indicator
- ❼ Speaker
- ❽ Charge contacts
- ❾ [☎] (Page/Intercom)
- ❿ [✓] (Memo)
- ⓫ [■] (Stop)
- ⓬ Microphone
- ⓭ Navigator key ([^]/[v]/[◀◀]/[▶▶])
- ⓮ [▶] (Message)/Message indicator
- ⓯ [×] (Erase)
- ⓰ [☎●] (Greeting record)
- ⓱ [☎▶] (Greeting check)
- ⓲ Display
- ⓳ [IP RESET]

BB-GT1540

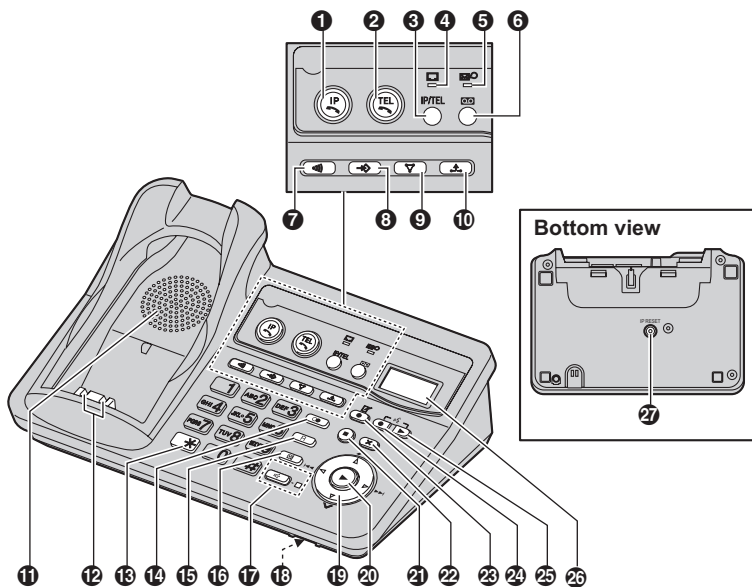

- | | |
|--|---|
| <p>1 [IP] (IP line)
IP indicator</p> <p>2 [TEL] (Landline)
TEL indicator</p> <p>3 [IP/TEL]</p> <p>4 [] (Status) indicator</p> <p>5 [] (Voice Mail) indicator</p> <p>6 [] (Answer on)
Answer on indicator</p> <p>7 [] (Page/Intercom)</p> <p>8 [↔] (Auto/Program)</p> <p>9 [∇] (Conference)</p> <p>10 [] (Hold)</p> <p>11 Speaker</p> <p>12 Charge contacts</p> <p>13 [∗]</p> <p>14 [] (Pause/Redial)</p> <p>15 [R] (Recall)</p> <p>16 [] (Mute)</p> | <p>17 [] (Speakerphone)
Speakerphone indicator</p> <p>18 Microphone</p> <p>19 Navigator key
([∧]/[∨]/[◀]/[▶])</p> <p>20 [▶] (Message)
Message indicator</p> <p>21 [■] (Stop)</p> <p>22 [×] (Erase)</p> <p>23 [] (Memo)</p> <p>24 [] (Greeting record)</p> <p>25 [] (Greeting check)</p> <p>26 Display</p> <p>27 [IP RESET]</p> |
|--|---|

Controls (Handset)

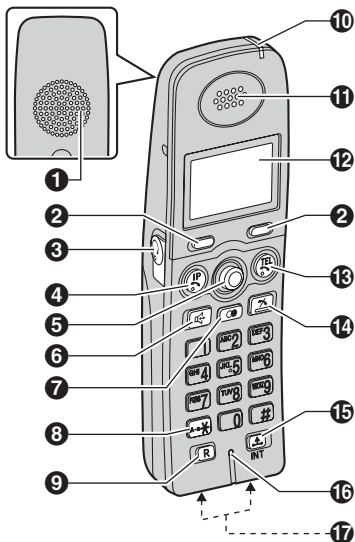

- 1 Speaker
- 2 Soft keys
- 3 Headset jack
- 4 [IP] (IP line)
- 5 Joystick
- 6 [☎] (Speakerphone)
- 7 [⏻] (Redial/Pause)
- 8 [*]
- 9 [R] (Recall)
- 10 Charge indicator
Ringer indicator
Message indicator
- 11 Receiver
- 12 Display
- 13 [TEL] (Landline)
- 14 [⏻] (Off)
- 15 [⏸] (Hold)
[INT] (Intercom)
- 16 Microphone
- 17 Charge contacts

Using the joystick

The handset joystick can be used to navigate through menus and to select items shown on the display, by pushing it up [▲], down [▼], left [◀], or right [▶].



The joystick can be used to select the centre soft key icon, by pressing down on the centre of the joystick.



Using the soft keys

The handset features 2 soft keys and a joystick. By pressing a soft key, or by pressing the centre of the joystick, you can select the feature shown directly above it on the display.

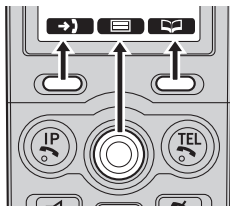



Installation

Connecting to a landline and the Internet (IP line)

Connect the base unit to a broadband router or modem with a built-in router.

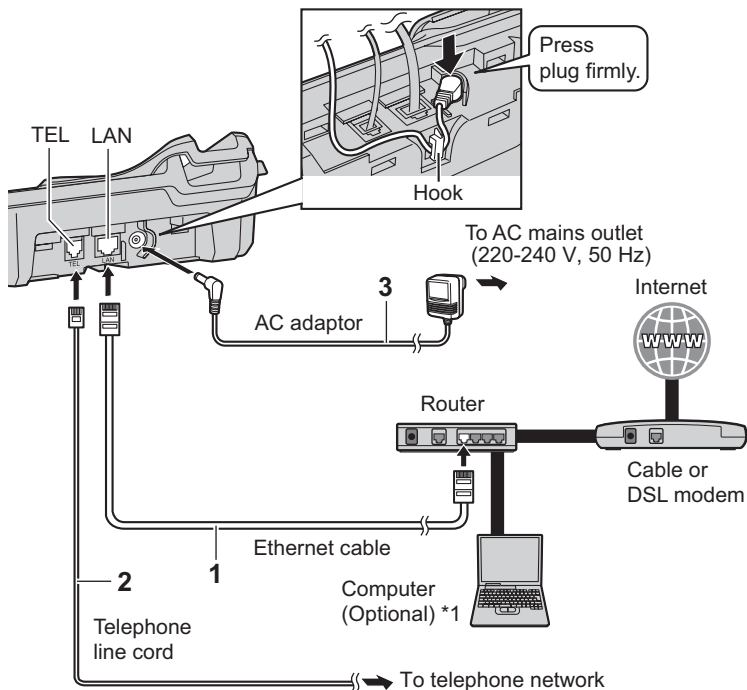
*1 Computer is not required for setup or making/answering internet calls.



- 1 Connect the supplied Ethernet cable until it clicks into the "LAN" port on the base unit and unused Ethernet (LAN) port on your router or modem with a built-in router.
- 2 Connect the supplied telephone line cord until it clicks into the "TEL" port on the base unit and telephone line jack.
- 3 Connect the supplied AC adaptor to the base unit by pushing the plug firmly, then plug the other end into the AC outlet.
 - Use only the supplied Panasonic AC adaptor.
 - The  indicator on the base unit lights in red for about 3 seconds (page 23).

4 Install the battery:

Press the notch of the handset cover firmly, and slide it in the direction of the arrow (1). Insert the battery (2), and press it down until it snaps into position (3). Then close the handset cover (4, 5).

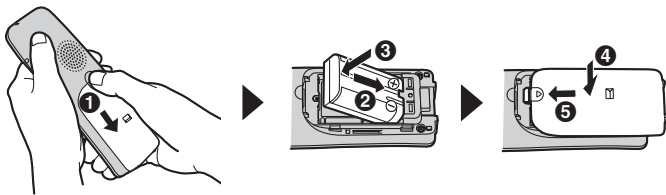
**5 Charge the battery:**

Place the handset on the base unit.

- If “Charge for 7 HRS” is displayed, wait for at most 15 minutes until “Please read joip Terms of Use. Agree?” is displayed.
- To fully charge the battery, place the handset on the base unit for 7 hours. For battery information, see page 21.

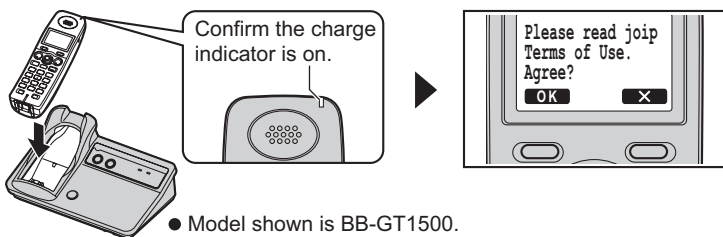

• Model shown is BB-GT1500.

6 Agree to the joip Terms of Use:

To use the joip IP line, read the Terms of Use for the joip services on the supplied leaflet or at www.joip.com then press **OK** (left soft key) while “Please read joip Terms of Use. Agree?” is displayed.

- To agree to the Terms of Use later, press **X**. When you want to agree, press **[IP]** and wait until the display changes from “Free calls! Plug internet cable. www.joip.com” to “Please read joip Terms of Use. Agree?”. Press **OK** to agree to it.

7 Check for Internet access:

Wait until the  indicator on the base unit turns green.

- When the  indicator on the base unit lights in green, the installation is complete. Your joip number is displayed on the handset 1 (supplied with your base unit). Once you start operations with the handset, it disappears from the display (page 31).

Preparation

- When the  indicator on the base unit does not light in green even if you wait for a few minutes, see page 24.

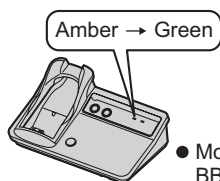

- Model shown is BB-GT1500.

Your joip number



Note:

- Never install telephone wiring during a lightning storm.
- The AC adaptor must remain connected at all times. (It is normal for the adaptor to feel warm during use.)
- The AC adaptor should be connected to a vertically oriented or floor-mounted AC outlet. Do not connect the AC adaptor to a ceiling-mounted AC outlet, as the weight of the adaptor may cause it to become disconnected.
- **The unit will not work during a power failure.** To use the landline, we therefore recommend you also connect a corded-type telephone (without AC adaptor) to the same telephone line using a T-adaptor. Your Panasonic sales shop can offer you more information about connection possibilities.

Location

- For maximum distance and noise-free operation, place your base unit:
 - away from electrical appliances such as TVs, radios, personal computers or other phones.
 - in a convenient, high and central location.

Connecting the AC adaptor (BB-GT1522)

To AC mains outlet
(220-240 V, 50 Hz)

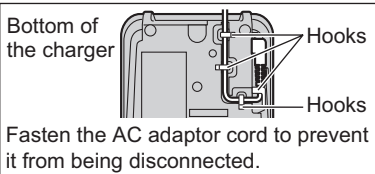
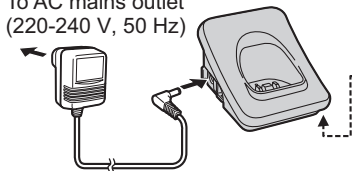

Battery charge

Battery charge

To fully charge the battery, place the handset on the base unit or charger for **7 hours**.

- While charging, the charge indicator on the handset lights in amber. When the battery is fully charged, the indicator lights in green.

Base unit

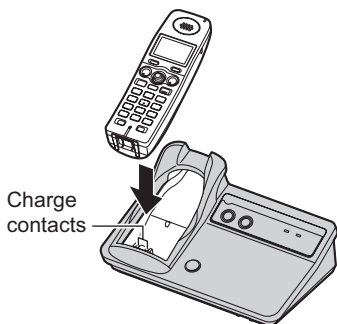

- Model shown is BB-GT1500.

Charger



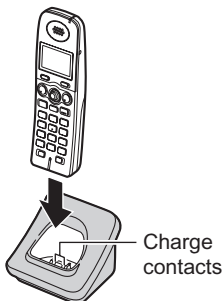

Available model:
BB-GT1522



Note:

- It is normal for the handset to feel warm during charging.
- If you want to use the handset immediately, charge the battery for at least 15 minutes.
- To ensure that the battery charges properly, clean the charge contacts of the handset, base unit, and charger with a soft, dry cloth once a month. Clean more often if the unit is subject to the exposure of grease, dust, or high humidity.

Battery level

Battery icon	Battery level
	Fully charged
	Medium
	Low Flashing: needs to be recharged.
	Empty

Note:

- When the battery needs to be charged, the handset beeps intermittently during use.

Panasonic battery performance

Operation	Operating time
While in use (talking)	Up to 8 hours
While not in use (standby)	Up to 14 days

Note:

- It is normal for the battery not to reach full capacity at the initial charge. Maximum battery performance is reached after a few complete cycles of charge/discharge (use).
- Battery operating time may be shortened over time depending on usage conditions and surrounding temperature.
- Battery power is consumed whenever the handset is off the base unit or charger, even when the handset is not in use.
- After the handset is fully charged, displaying “Charge completed”, it may be left on the base unit or charger without any ill effect on the battery.
- The battery level may not be displayed correctly after you replace

the battery. In this case, place the handset on the base unit or charger and let it charge for 7 hours.

Battery replacement

Important:

- Use only the rechargeable Panasonic battery noted on page 9.

Replace the old battery with a new one. See page 19, step 4.

Understanding the indicators on the base unit

TEL indicator/IP indicator



The TEL indicator and IP indicator show the status of the landline and IP line, respectively, as follows.





Status	Meaning
Light off	The line is available.
Light on	The line is in use.*1
Flashing rapidly	A call is being received.
Flashing	A call is put on hold. The answering system is answering a call. (BB-GT1520/BB-GT1522/BB-GT1540) The IP indicator flashes when the base unit software is being downloaded from the joip service.

*1  When another phone uses the same landline, the TEL indicator lights.

(Status) indicator

During the startup process you may notice that the  indicator on the base unit is flashing. This indicates that the base unit is booting up with the joip service. You may find the following flash patterns helpful to you:

Status		Meaning
Colour	Light pattern	
Green	On	<ul style="list-style-type: none"> The base unit is connected to the Internet. The startup process is complete and you may now make and receive joip internet calls.
	Flashing	<ul style="list-style-type: none"> The base unit is downloading data from the joip service. Do not disconnect the Ethernet cable or AC adaptor from the base unit until the  indicator stops flashing and lights in steady green.
Red	On	<ul style="list-style-type: none"> When the base unit is turned on, the  indicator lights in red for about 3 seconds.
	Flashing	<ul style="list-style-type: none"> The base unit is registering a handset.
	Flashing rapidly	<ul style="list-style-type: none"> The base unit is paging handsets. (BB-GT1500)

Status		Meaning
Colour	Light pattern	
Amber	On	<ul style="list-style-type: none"> The base unit's IP address may conflict with the IP addresses of other devices on your local network. Check the base unit's static IP address using the handset:  → [*][5][0][1], then check the IP addresses of the other devices on your local network. If necessary, change the base unit's static IP address (page 30).
	Flashing	<ul style="list-style-type: none"> The base unit is obtaining an IP address or is obtaining configurations from the joip service. Please wait. The base unit is registering with the joip service. Please wait. If the  indicator continues flashing, check the following: <ul style="list-style-type: none"> Check the base unit's IP address using the handset:  → [*][5][0][1] If necessary, change the base unit's static IP address (page 30). If an IP address was not acquired, check your network devices' (router, modem, etc.) connections. If the connections are made properly but the problem persists, check your network devices' (router, modem, etc.) settings. Many installation issues can be resolved by resetting all the equipment. First, shut down your modem, router, base unit, and computer. Then turn the devices back on one at a time in this order: modem, router, base unit, computer. If you cannot access Internet Web pages using your computer, check to see if your Internet service provider is having connection issues in your area. For more troubleshooting help, visit www.joip.com or contact the joip service provider.
	Flashing rapidly	<ul style="list-style-type: none"> Unplug the base unit's AC adaptor to reset the unit, then reconnect the AC adaptor. If the  indicator is still flashing rapidly, there may be a problem with the base unit hardware. Contact Panasonic service personnel.





Status		Meaning
Colour	Light pattern	
OFF	—	<ul style="list-style-type: none"> • The power on the base unit is off. • To use the joip IP line, you need to agree to the Terms of Use for the joip services using the handset (page 19). • The Ethernet cable is not connected properly. Connect it. • Your network devices (hub, router, etc.) are turned off. Check the LEDs for the link status of the devices.



Displays

Base unit display items





Available model:











BB-GT1520/BB-GT1522/BB-GT1540



Displayed item	Meaning
	Base unit ringer for landline is off (page 59).
	Base unit ringer for IP line is off (page 59).
	Greeting or voice memo recording error (page 61, 63)
Example: <i>H I</i>	Handset number: displayed when paging, or being paged (example shown here: handset 1).
<i>H</i>	Paging all handsets (page 71)
	Landline is selected for the answering system or ringer setting (page 59, 60). When flashing: the answering system is answering a landline call or playing a message on the landline (page 61).

Displayed item	Meaning
	IP line is selected for the answering system or ringer setting (page 59, 60). When flashing: the answering system is answering an internet call or playing a message on the IP line (page 61).
	Base unit is in programming mode (page 43). (BB-GT1540)

Handset display items















Displayed item	Meaning
	Alarm is on (page 55).
	Within range of the base unit
	Handset has no link to base unit (out of range of base unit, handset is not registered to base unit, or no power on base unit).
	Battery level
	Landline is in use.* ¹ When flashing: – a landline call is on hold. – the answering system is answering a landline call.* ² When flashing rapidly: a landline call is being received.









Displayed item	Meaning
	IP line is used. When flashing: – an internet call is on hold. – the answering system is answering an internet call.*2 When flashing rapidly: an internet call is being received.
	Speaker is on.
	Call privacy mode is on (page 34).
Example: 	The handset's extension number (example shown here: handset 1)
	Handset ringer for landline is off (page 52).
	Handset ringer for IP line is off (page 52).
	Handset ringers for landline and IP line are off (page 52).
	joip text message is protected (page 74).
	Night mode is on. (page 58)
	Dial lock is on. (page 58)

*1  When another phone uses the same landline,  is displayed.

*2 BB-GT 1520/BB-GT 1522/
BB-GT 1540







Soft key icons

Soft key icon	Action
	Returns to the previous screen.
	Allows you to make a call. Answers an intercom call.
	Displays the menu.
	Mutes your voice.
	Opens the caller list.
	Accepts the current selection.
	Opens the handset phonebook.
	Displays the phonebook search menu.
	Sends the handset phonebook item(s) to selected handset to copy.
	Edits the handset phonebook item.
	Adds the handset phonebook item.
	Switches between AM, PM, and 24-hour time entry.
	Changes the character entry mode.
	Stops playback. (BB-GT 1520/BB-GT 1522/BB-GT 1540)
	Erases the selected item. Cancels the base unit software update.

Soft key icon	Action
	Saves the handset phonebook item.
	Erases the character or number.
	Goes to the next screen.
	Establishes a conference call.
	Protects a joip text message.
	Turns off the handset ringer.
	Plays the message(s).
	Registers the handset to the base unit.

Handset menu icons

When in standby mode, pressing down on the centre of the joystick () reveals the handset's main menu. From here you can access various features and settings.

Menu icon	Menu/feature
	joip (For joip services)
	Answer System (BB-GT1520/ BB-GT1522/ BB-GT1540)
	Phonebook (BB-GT1500)
	Ringer settings
	Set Date & Time
	Initial settings
	Customer support

Configuring the Internet connection settings

If your local network uses a DHCP (Dynamic Host Configuration Protocol) server for automatic IP address assignments, you do not need to change any settings. If your local network uses a static IP address, turn the DHCP connection mode off.

Leaving the DHCP connection mode on allows the base unit to receive an IP address automatically from a DHCP server on your local network.

Automatic setup (default)



The base unit automatically obtains an IP address and other Internet connection settings (subnet mask, default gateway, and DNS server addresses).

Turning the DHCP connection mode on:

1  → [F5][0][0]

2 [▼]/[▲]: “On”

3 **OK** → [↵]

- Wait until the  indicator on the base unit turns green. When the  indicator lights in green, the setting is complete. Confirm your joip number (page 31).
- When the  indicator on the base unit does not light in green even if you wait for a few minutes, see page 24.

Note:

- To view the Internet connection settings:

 → [F5][5][0][1] → When finished, press [↵].

Static setup

If your local network does not use a DHCP server for automatic IP address assignments, turn the DHCP connection mode off first. Then set the static IP address and other Internet connection settings corresponding to your local network.

Turning the DHCP connection mode off:

1  → [F5][5][0][0]

2 [▼]/[▲]: “Off”

3 **OK** → [↵]

Setting the static IP address and other settings:

1  → [F5][5][0][1]

2 Set the IP address and other settings.

- Push the joystick down [▼] or up [▲] to move between the following 5 items.



IP address	Enter the IP address in this data field.* ¹ <ul style="list-style-type: none"> • Set 4 numbers (0-255) separated by periods such as “192.168.0.253”.
Subnet mask	Enter the subnet mask in this data field.* ¹ <ul style="list-style-type: none"> • Set 4 numbers (0-255) separated by periods such as “255.255.255.0”.
Default gateway	Enter the default gateway address in this data field.* ¹ <ul style="list-style-type: none"> • Set 4 numbers (0-255) separated by periods such as “192.168.0.1”.

DNS1 (DNS server 1)	Enter the DNS (Domain Name System) server addresses, in each data field.*1 ● Set 4 numbers (0-255) separated by periods such as "172.23.0.100".
DNS2 (DNS server 2)	

- To move the cursor, push the joystick right [▶] or left [◀]. To correct digits, press **C**.

*1 There are some restrictions on these entries. For example, "0.0.0.0" and "255.255.255.255" are not available.

3 **OK** → [↵]

- Wait until the  indicator on the base unit turns green. When the  indicator lights in green, the setting is complete. Confirm your joip number (page 31).
- When the  indicator on the base unit does not light in green even if you wait for a few minutes, see page 24.

Confirming your joip numbers

After the installation is complete (page 18, 30), the unit is registered to the service and you receive your joip number. The joip number is displayed on handset 1 (supplied with the base unit). Once you start operations with the handset, it disappears from the display. You can also view your joip number using any handset as follows.

1 → [✱][1][0][3]

- The joip number is displayed.
- To view additional phone number(s) for the IP line, push the joystick down [▼] or up [▲].*1

2 [↵]

*1 To receive calls via the IP line from landline phones or mobile phones, you need to specially subscribe for additional phone number(s) from joip at www.joip.com (page 4).

Making calls

Important:

- You can choose the landline or IP line to make a call. Make sure to choose the appropriate line for the phone number.
- To call a Panasonic GLOBARANGE phone, dial the joip number consisting of a # followed by 10 digits (page 4).

Using the handset

- 1 Dial the phone number.
 - To correct a digit, press **C**.
- 2 To make a landline call, press **[TEL]**.
To make a joip internet call, press **[IP]**.
- 3 When you finish talking, press **[⏏]** or place the handset on the base unit or charger.

Note:

- **[IP]** To make calls from your joip number to landline and mobile phone numbers via your IP line, you need to subscribe to the appropriate service at www.joip.com

When calling, you may not hear ringtones from your receiver/speaker for more than 1 minute as the unit tries to access the destination phone number. This is normal, please wait.

- You can also make a call by pressing **[📞]** in step 2. The line set for line selection mode is automatically selected (page 29). When a joip number is dialled (page 3), the IP line is selected.
- **[IP]** If it takes some time to call the number in step 2, press **[⏏]** to call it immediately.

Using the speakerphone

- 1 Dial the phone number, and press **[📞]**.
 - The line set for line selection mode is automatically selected (page 29). When a joip number is dialled (page 3), the IP line is selected.
 - Speak alternately with the other party.
- 2 When you finish talking, press **[⏏]**.

Note:

- Use the speakerphone in a quiet environment.
- To switch to the receiver, press **[📞]**.

Adjusting the receiver/speaker volume

Push the joystick up or down while talking.

Making a call using the redial list

The last 10 phone numbers dialled are stored in the redial list (each 48 digits max.). **[L]** (landline) and **[IP]** (IP line) indicate which line you made the call on.

- 1 **[📞]**
- 2 **[▼]/[▲]**: Select the desired phone number.
- 3 Press **[📞]** or **[📞]**.
 - The indicated line is selected.
 - You can also select the line by pressing **[TEL]** or **[IP]**.
 - **[TEL]** If **[📞]** is pressed and the other party's line is engaged, the unit will automatically redial multiple times. The ringer indicator flashes. To cancel, press **[⏏]**.

Note:

- The caller's name is not stored in the redial list when calling back a number from the caller list.

Erasing a number in the redial list

- 1 **[☉]**
- 2 **[▼]/[▲]**: Select the desired phone number.
- 3 **[X]** → **[▼]/[▲]**: “Yes” → **OK** → **[↵]**

Pause button

A pause is sometimes required when making calls, for example using a PBX or long distance service. When storing a calling card access number and/or PIN in the phonebook, a pause is also needed (page 42).

For example, if you need to dial the line access number “0” when making outside calls with a PBX:

- 1 **[0]** → **[☉]** → Dial the phone number.
- 2 **[TEL]**

Note:

- A 3 second pause is inserted each time **[☉]** is pressed. Press repeatedly to insert longer pauses.

Handset LCD backlight

The handset’s LCD backlight colour changes as follows.

Colour	Meaning
Green	Landline is used.
Amber	IP line is used.

Answering calls

Using the handset 

When a call is being received, the ringer indicator on the handset flashes rapidly.

- 1 To answer the landline call, press ****, **[TEL]**, or **[☎]**.

To answer the joip internet call, press ****, **[IP]**, or **[☎]**.

- You can also answer the call by pressing any dial key from **[0]** to **[9]**, **[*]**, or **[#]**. (**Any key talk feature**)

- 2 When you finish talking, press **[↵]**.

Note:

- You can change the ringer indicator colour and the ringtone (page 52, 54). You can also adjust the handset ringer volume (page 52).

Auto talk

This feature allows you to answer a call by simply lifting the handset off the base unit or charger. You do not need to press ****, **[TEL]**, or **[IP]**. To activate this feature, see page 51.

Temporary ringer off

While the handset is ringing for an outside call, you can turn the ringer off temporarily by pressing **** or **[↵]**.

Useful features during a call

Hold button 

This feature allows you to put an outside call on hold.

Press **[↵]** 2 times during an outside call.

- To release hold, press **[TEL]** or **[IP]**.
- A user of another unit can take the call by pressing **[TEL]** or **[IP]**.

Note:

- If a call is kept on hold for more than 9 minutes, an alarm tone starts to sound and the ringer indicator flashes

rapidly. After 1 additional minute on hold, the call is disconnected.

- **TEL**▶ If another phone is connected to the same line (page 20), you can also take the call by lifting its handset.

Mute button

While mute is turned on, you can hear the other party, but the other party cannot hear you.

To mute your voice, press **[M]**.

- To return to the conversation, press **[M]**.

Note:

- When this feature is turned on, **[M]** flashes.

[R] button

TEL▶

Pressing **[R]** allows you to use special features of your host PBX such as transferring an extension call, or accessing optional telephone services.

Note:

- To change the recall time, see page 57.

IP▶

Pressing **[R]** allows you to use optional services from joip. Visit www.joip.com or contact the joip service provider for details.

Making another call on the IP line:

While you are talking with an outside caller, you can make a 2nd call on the same line by pressing **[R]** then dialling.

- The 1st call is put on hold.
- To hang up the 2nd call, press **[*]**. The alarm tone starts to sound. Press **[IP]** to talk with the 1st caller again. If you do not press **[IP]**, the alarm tone sounds for 1 minute and the 1st call is disconnected.

You can combine the calls to make a conference call by pressing **[R]** again after the 2nd call is connected.

- To hang up the 2nd call and talk with the 1st caller, press **[R]**.
- To hang up both lines, press **[*]**.

For Call Waiting service users



Call Waiting service is provided by your landline service provider and joip.

This feature allows you to receive calls while you are already talking on the phone. If you receive a call while on the phone, you will hear a Call Waiting tone. Press **[R]** to answer the 2nd call.

- To switch between calls, press **[R]**.

Note:

- **TEL**▶ Please contact your landline service provider for details.
- **IP**▶ Please visit www.joip.com or contact the joip service provider for details.

Call share

This feature allows you to join an existing outside call.

When another unit is on an outside call, press **[TEL]** or **[IP]** to select the line that is being used for the call.



Note:

- Multiple parties can join a conference call. The possible number of participating parties depends on the current system usage. When another participating party cannot join a conversation, the busy tone sounds and the handset displays "Busy".

Call privacy

Call privacy allows you to prevent other users from joining your conversations with outside callers. To allow other users

to join your conversations, leave this feature off.

- 1 Press  during an outside call.
- 2 Press **[2]** to select “**Privacy on**” or “**Privacy off**”.
 - When this feature is turned on, “” is displayed.

Note:

- This feature will turn off after you hang up the call.

Using the other line, conference call

When a call is being received on the other line during a conversation, the interrupt tones sound.

You can answer the 2nd call while holding the 1st call. You can also combine the landline call and internet call to make a conference call.

Example: If you are using the landline

- 1 Press **[↕]** 2 times to put the 1st call (landline) on hold.
- 2 Press **[IP]** to make or answer a 2nd call.
 - To hold the 2nd call, press **[↕]** 2 times.

3 To hang up the 2nd call and return to the 1st call (landline):

Press **[TEL]**.

To make a conference call:

Press .

- To hang up only one line, press **[TEL]** or **[IP]** for the party with which you want to continue talking.
- To put both lines on hold, press **[↕]**. To talk with only one caller, press **[TEL]** or **[IP]** for the party with which you want to continue talking. To resume both lines, press .

Note:

- If you subscribe to the Caller ID service, the 2nd caller's information is displayed as the call is being received (page 44).
- To turn the interrupt tone off, see page 51.

Making calls

Important:

- You can choose the landline or IP line to make a call. Make sure to choose the appropriate line for the phone number.
- To call a Panasonic GLOBARANGE phone, dial the joip number consisting of a # followed by 10 digits (page 4).

Using the base unit

Available model:

BB-GT1540

- 1 To make a landline call, press **[TEL]**.
To make a joip internet call, press **[IP]**.
 - You can also make a call by pressing **[☎]**. The line set for line selection mode is automatically selected (page 29).
- 2 Dial the phone number.
- 3 When the other party answers, speak into the MIC.
 - Speak alternately with the other party.
- 4 When you finish talking, press **[☎]**.

Note:

- Use the speakerphone in a quiet environment.
- **[IP]** To make calls from your joip number to landline and mobile phone numbers via your IP line, you need to subscribe to the appropriate service at www.joip.com
When calling, you may not hear ringtones from your speaker for more than 1 minute as the unit tries to

access the destination phone number. This is normal, please wait.

- **[IP]** If it takes some time to call the number in step 2, press **[☎]** to call it immediately.
- While on a call, you can switch from the base unit to the handset:
 - Press **[TEL]** or **[IP]** on the handset, then press **[☎]** on the base unit.
 - If the handset is on the base unit, simply lift it.

Adjusting the speaker volume

Press **[^]** or **[v]** repeatedly while talking.

Redialling the last number dialled

Press **[TEL]** or **[IP]**. → **[☎]**

- **[TEL]** If the other party's line is engaged, the unit will automatically redial multiple times. The speakerphone indicator flashes. To cancel, press **[■]**.

Answering calls

Using the base unit

Available model:

BB-GT1540

When a call is being received, the TEL indicator or IP indicator flashes rapidly.

- 1 **[☎]**
 - You can also answer the call by pressing the flashing **[TEL]** or **[IP]**.
- 2 Speak into the MIC.
- 3 When you finish talking, press **[☎]**.

Useful features during a call

Available model:
BB-GT1540

Hold button

This feature allows you to put an outside call on hold.

Press **[⏸]** during an outside call.

- To release hold, press the flashing **[TEL]** or **[IP]**.
- A handset user can take the call by pressing **[TEL]** or **[IP]**.

Note:

- While an outside call is on hold, the TEL indicator or IP indicator on the base unit flashes.
- If a call is kept on hold for more than 9 minutes, an alarm tone starts to sound. After 1 additional minute on hold, the call is disconnected.
- **[TEL]** If another phone is connected to the same line (page 20), you can also take the call by lifting its handset.

Mute button

While mute is turned on, you can hear the other party, but the other party cannot hear you.

To mute your voice, press **[M]**.

- To return to the conversation, press **[M]** or **[📞]**.

[R] button

[TEL]

Pressing **[R]** allows you to use special features of your host PBX such as transferring an extension call, or accessing optional telephone services.

Note:

- To change the recall time, see page 57.

[IP]

Pressing **[R]** allows you to use optional services from joip. Visit www.joip.com or contact the joip service provider for details.

Making another call on the IP line:

While you are talking with an outside caller, you can make a 2nd call on the same line by pressing **[R]** then dialling.

- The 1st call is put on hold.
- To hang up the 2nd call, press **[📞]**. The alarm tone starts to sound. Press **[IP]** to talk with the 1st caller again. If you do not press **[IP]**, the alarm tone sounds for 1 minute and the 1st call is disconnected.

You can combine the calls to make a conference call by pressing **[R]** again after the 2nd call is connected.

- To hang up the 2nd call and talk with the 1st caller, press **[R]**.
- To hang up both lines, press **[📞]**.

For Call Waiting service users



Call Waiting service is provided by your landline service provider and joip.

This feature allows you to receive calls while you are already talking on the phone. If you receive a call while on the phone, you will hear a Call Waiting tone. Press **[R]** to answer the 2nd call.

- To switch between calls, press **[R]**.

Note:

- **[TEL]** Please contact your landline service provider for details.
- **[IP]** Please visit www.joip.com or contact the joip service provider for details.

Call share

This feature allows you to join an existing outside call.

When a handset is on an outside call, press **[TEL]** or **[IP]** to select the line that is being used for the call.

Note:

- Multiple parties can join a conference call. The possible number of participating parties depends on the current system usage. When another participating party cannot join a conversation, the busy tone sounds.

Using the other line, conference call

When a call is being received on the other line during a conversation, the interrupt tones sound.

You can answer the 2nd call while holding the 1st call. You can also combine the landline call and internet call to make a conference call.

Example: If you are using the landline

- 1 Press **[↕]** to put the 1st call (landline) on hold.
- 2 Press **[IP]** to make or answer a 2nd call.
 - To hold the 2nd call, press **[↕]**.
- 3 **To hang up the 2nd call and return to the 1st call (landline):** Press **[TEL]**.
To make a conference call: Press **[▽]**.
 - To hang up only one line, press **[TEL]** or **[IP]** for the party with which you want to continue talking.
 - To put both lines on hold, press **[↕]**. To talk with only one caller, press **[TEL]** or **[IP]** for the party with which you want to continue

talking. To resume both lines, press **[▽]**.

Note:

- To turn the interrupt tone off, see page 51.

Making internet calls using your mobile phone

Available model:

BB-GT1520/BB-GT1522/BB-GT1540



Important:

- To use this feature, you need an additional phone number for the IP line other than the joip number (page 4). If you do not have one, subscribe at www.joip.com

You can make internet calls with your mobile phone via the base unit. First, call your unit's answering system by dialling the additional phone number you subscribed at www.joip.com

Next, dial the phone number you want to call. You can make cheaper international calls, even while you are out.

Perform the following beforehand:

- Set your own remote code of the answering system to turn the remote operation on (page 64).
- Turn on the answering system for the IP line (page 60, 65).

- 1 Dial the phone number you subscribed at www.joip.com
- 2 After the greeting message starts, enter your remote code of the answering system (page 64).
- 3 **[#][9]**
- 4 After the dial tone sounds, dial the phone number you want to call. → **[#]**
 - The phone number is dialled via the IP line.
- 5 When you finish talking, hang up.

Note:

- The handset or base unit cannot join the call.

Turning this feature on or off

The default setting is ON. If you do not want to use this feature, you can turn it off using the base unit.

First press and hold **[■]**, then press and hold **[IP/TEL]**. Keep holding down both buttons until the base unit beeps.

- When turned on, one beep sounds.
- When turned off, 2 beeps sound.



Handset phonebook

You can add up to 100 items to the handset phonebook and search for phonebook items by name.



Important:

- Caller ID subscribers can use ringer ID and light-up ID features (page 45).
- You can add and edit phonebook items by accessing your account on the joip website (www.joip.com), then downloading your web phonebook to the base unit. To import them to your handset, see page 73.

Adding items to the handset phonebook

- 1 
- 2 
- 3 Enter the name (max. 16 characters; page 79). → **OK**
- 4 Enter the phone number (max. 32 digits). → **OK**
 - If you do not need to assign the ringer ID and light-up ID, go to step 9.
- 5 **[▼]/[▲]**: “Set Ringer ID” → **OK**
- 6 **[▼]/[▲]**: Select the desired ringer ID (page 45). → **OK**
 - When selecting “No Ringer ID”, the ringtone set for the IP line rings (page 54).
- 7 **[▼]/[▲]**: “Set Light-up ID” → **OK**
- 8 **[▼]/[▲]**: Select the desired light-up ID (page 45). → **OK**
- 9 
 - To add other items, repeat from step 3.
- 10 **[✕]**

Note:

- In step 2, you can also press  → **[▼]/[▲]**: “New Entry” → **OK** instead of pressing .
- If you select “No Ringer ID” (default) in step 6, the handset uses the ringtone you selected on page 54 when a call is received from that caller.
- If you select “No Light-up ID” (default) in step 8, the handset uses the ringer indicator colour you selected on page 52 when a call is received from that caller.

To store emergency numbers

Emergency numbers are numbers stored in the phonebook that can be dialled using the phonebook even when dial lock is turned on (page 58). To store a number as an emergency number, add # at the beginning of the name (see “Adding items to the handset phonebook”, page 40).

Finding and calling a handset phonebook item

Important:

- Make sure to choose the appropriate line for the phone number to call back.

Searching for a name alphabetically by scrolling through all items



- 1 
- 2 **[▼]/[▲]**: Select the desired item.
- 3 To make a landline call, press **[TEL]**.
To make a joip internet call, press **[IP]**.

Searching for a name by initial

- 1  → **A/B/C**

- 2 **[▼]/[▲]**: Select the character entry mode that contains the character you are searching for (page 79). → **OK**
- 3 Press the dial key (**[0]** – **[9]**, or **[#]**) that corresponds to the first letter you are searching for (page 79).
 - If there is no item corresponding to the letter you selected, the next item is displayed.
- 4 **[▼]/[▲]**: Select the desired item.
- 5 To make a landline call, press **[TEL]**.
To make a joip internet call, press **[IP]**.

Editing items in the handset phonebook

- 1 
- 2 Find the desired item (page 40). → 
- 3 **[▼]/[▲]**: Select the information you want to change.

To change the name or phone number	Select the name or phone number. → OK → Edit the information (page 79). → OK
To change the ringer ID	Select the current ringer ID. → OK → [▼]/[▲] : Select the desired item. *1 → OK *1 To turn the ringer ID off, select “No Ringer ID”.



To change the light-up ID

Select the current light-up ID. → **OK**
→ **[▼]/[▲]**: Select the desired light-up ID. *1 → **OK**
*1 To turn the light-up ID off, select “No Light-up ID”.



- 4  → **[↵]**

Erasing items in the handset phonebook

Erasing an item



- 1 
- 2 Find the desired item (page 40).
- 3  → **[▼]/[▲]**: “Erase” → **OK**
- 4 **[▼]/[▲]**: “Yes” → **OK** → **[↵]**

Erasing all items

- 1  → 
- 2 **[▼]/[▲]**: “Erase All” → **OK**
- 3 **[▼]/[▲]**: “Yes” → **OK**
- 4 **[▼]/[▲]**: “Yes” → **OK**
 - When all items have been erased, “Erased” is displayed.
- 5 **[↵]**

Chain dial

This feature allows you to dial phone numbers in the handset phonebook while you are on a call. This feature can be used, for example, to dial a calling card access number or bank account PIN that you have stored in the handset phonebook, without having to dial manually.

- 1 During an outside call, press .
- 2 Find the desired item (page 40). → 

Note:

- When storing a calling card access number and your PIN in the phonebook as one phonebook item, press **[Ⓞ]** to add pauses after the number and PIN as necessary (page 33).





Copying handset phonebook items

You can copy one or all of the phonebook items from one handset to another.



Important:

- Ringer ID and light-up ID for phonebook items are not copied.

Copying an item

- 1 
- 2 Find the desired item (page 40). → 
- 3 **[▼]/[▲]:** “Copy” → **OK**
- 4 **[▼]/[▲]:** Select the handset to copy to. → 
 - When the item has been copied, “Completed” is displayed.
 - To continue copying another item:
[▼]/[▲]: “Yes” → **OK** → Find the desired item (page 40). → 
- 5 **[↶]**

Copying all items

- 1  → 
- 2 **[▼]/[▲]:** “Copy All” → **OK**
- 3 **[▼]/[▲]:** Select the handset to copy to. → 
 - When all items have been copied, “Completed” is displayed.
- 4 **[↶]**

Base unit speed dialler

Available model:

BB-GT1540

You can assign one phone number to each of the 10 dial keys ([0] – [9]) on the base unit.

Adding phone numbers to the speed dialler

Important:

- Before adding phone numbers, make sure the base unit is not being used.

1 [→]

2 Enter the phone number (max. 32 digits).

- If a pause is required for dialling, press [⏸] where needed.
- If you misdial, press [■] and repeat from step 1.

3 [→]

4 Press a dial key ([0] – [9]).

Note:

- If a phone number is assigned to a dial key which already contains a phone number, the old number will be erased.
- We recommend you make a note of which phone numbers are stored in which dial keys.
- When [✖] is pressed, “✖” is displayed.
When [≡] is pressed, “≡” is displayed.
When [R] is pressed, “F” is displayed.

PAUSE button

A pause is sometimes required when making calls, for example using a PBX or long distance service. If you need to

dial the line access number “0”

(example) when making landline calls with a PBX:

In step 2, press [0], [●], then enter the phone number.

Note:

- A 3 second pause is inserted each time [●] is pressed. Press repeatedly to insert longer pauses. “P” is displayed when [●] is pressed.

To erase a stored phone number

1 Press [→] 2 times.

2 Press the desired dial key ([0] – [9]).

Calling someone with the speed dialler

Important:

- Make sure to choose the appropriate line for the phone number.

1 To make a landline call, press [TEL].

To make a joip internet call, press [IP].

2 [→]

3 Press the desired dial key ([0] – [9]).

Note:

- Speed dial numbers assigned to the base unit dial keys can only be dialled from the base unit.

Using Caller ID service

This unit is Caller ID compatible. To use Caller ID features, you must subscribe to Caller ID services offered by your landline service provider and the joip service provider.

Note:

- **TEL** Please contact your landline service provider for details.
- **IP** Please visit www.joip.com or contact the joip service provider for details.

Caller ID features

TEL

When an outside call is being received, the calling party's phone number is displayed.

- Generally caller information is displayed from the 2nd ring.

IP

When a call is received from a Panasonic GLOBALRANGE phone, the calling party's joip number is displayed. If the caller sets to show the name at www.joip.com, it is displayed.

Caller information for the last 50 callers is logged in the caller list from the most recent call to the oldest.

- If the unit cannot receive caller information, the following is displayed:
 - **"Private Caller"**: The caller requested not to send caller information.
 - **TEL "Out of Area"**: The caller dialed from an area which does not provide Caller ID service.
- **TEL** If the unit is connected to a PBX system, caller information may not be received properly. Consult your PBX supplier.

Missed calls

If a call is not answered, the unit treats the call as a missed call. **"Missed call"** is displayed on the handset. This lets you know if you should view the caller list to see who called while you were out. You can view the number of missed calls by pressing **→**.

Note:

- If you press **→**, then press **↶** without viewing all missed calls in the caller list, **"Missed call"** disappears from the display. When you receive another new call, it is displayed again.

Custom name display

When the Caller ID number is received and it matches a phone number stored in the phonebook, the stored name from the phonebook is displayed and logged in the caller list.

Call Waiting Caller ID display

The 2nd caller's information is displayed after you hear a call waiting tone (page 34). Press **[R]** to answer the 2nd call.

- To switch between calls, press **[R]**.

Note:

- **TEL** You must subscribe to both Caller ID and Call Waiting with Caller ID services. Please contact your landline service provider for details and availability of this service in your area.
- **IP** Please visit www.joip.com or contact the joip service provider to subscribe.

Ringer ID/Light-up ID

These features can help you identify who is calling by using different ringers and ringer indicator colours for different callers stored in the phonebook. You can assign a different ringer and indicator colour to each phonebook item. When a call is received from a caller stored in the phonebook, the assigned ringer rings and the assigned ringer indicator colour flashes after Caller ID information is displayed.

If you select “No Ringer ID” (default) or “No Light-up ID” (default), the handset uses the ringtone or ringer indicator colour you selected (page 52, 54) when a call is received from that caller.

Caller list

Important:

- Only 1 person can access the caller list at a time.

Viewing the caller list and calling back

- 1 
- 2 Push the joystick down to search from the most recent call, or push the joystick up to search from the oldest call.
- 3 To call back, select the indicated line by pressing **[TEL]** or **[IP]**. To exit, press **[*]**.



Note:

- **[T]** (landline) and **[IP]** (IP line) indicate which line the caller information was received from.

- A **✓** is displayed for caller information which has already been viewed or answered by any handset.
- If an arrow (**▶**) is displayed after the number, the whole phone number is not shown. Push the joystick right to see the remaining information. To return to the previous display, push the joystick left.

Editing a caller's phone number before calling back



You can edit a phone number in the caller list.

- 1 
- 2 **[▼]/[▲]**: Select the desired item. → 
- 3 Add or erase digits to the beginning of the number as necessary.
 - To add a digit, press the desired dial key.
 - To erase a digit, press **[C]**.
- 4 Press .

Note:

-  is not displayed for joip numbers. They are not necessary to be edited.
- The edited phone number is not saved in the caller list.









Storing caller information into the handset phonebook

- 1 
- 2 **[▼]/[▲]**: Select the desired item. → 
- 3 **[▼]/[▲]**: “Add Phonebook” → **[OK]**
 - To change the information, perform step 3, “Editing items in the handset phonebook”, page 41.

4  → 

Erasing caller information

Erasing a selected item

- 1 
- 2 /: Select the desired item.
- 3  → /: “Yes” → 
→ 

Erasing all items

- 1 
- 2  → /: “Yes” → 

Programmable settings

Handset

You can customise the unit by programming the following features.

To access the features, there are 2 methods:

- scrolling through the display menus (page 47)
- using the direct commands (page 51)

Base unit

To change the base unit ringer volume and tone, see page 59. (BB-GT1520/BB-GT1522/BB-GT1540)





Programming by scrolling through the display menus

- 1 
- 2 Push the joystick up [**▲**], down [**▼**], left [**◀**], or right [**▶**] to select the desired menu. → **OK**
 - If there are sub-menu(s), push the joystick down [**▼**] or up [**▲**] to select the desired item. → **OK**
- 3 Push the joystick down [**▼**] or up [**▲**] to select the desired setting. → **OK**
 - This step may vary depending on the feature being programmed.
- 4 [**↶**]

BB-GT1500



Main menu	Sub-menu 1	Sub-menu 2	Page
joip joip	joip service	–	75
	joip message	–	74
	My joip numbers	–	31
	joip settings	DHCP ^{*1}	
IP settings ^{*1}			30
joip MSG alert			75
Phonebook 	–	–	40

Programming



Main menu	Sub-menu 1	Sub-menu 2	Page
Ringer settings 	Ringer Volume	–	–
	Ext. Ringtone (External ringtone)	–	54
	Import ringtone	–	73
	Interrupt tone	–	–
	Ring colour	–	–
	Night Mode	Start/End	58
	On/Off	58	
	Ring Delay	59	
Set Date & Time 	Set Date & Time ^{*1}	–	29
	Alarm	–	55
	Time Adjustment ^{*1}	–	–
Initial settings 	Dial lock ^{*1}	–	57
	Auto Intercom	–	69
	Contrast	–	–
	Keytones	–	–
	Auto Talk	–	33
	New Msg. Alert	–	68
	IP/TEL select	–	29
	Base Unit Setup	Base Unit PIN ^{*1}	56
	Set phone line	Set recall time ^{*1}	57
	Registration	Register Handset	77
		Deregistration	77
	Handset Name	–	56
	Calling Code	–	55
Select Language	–	29	
Customer support 	Web site	–	52
	Software version ^{*1}	–	57

*1 If you program these settings using one of the handsets, you do not need to program the same item using another handset.

BB-GT1520/BB-GT1522/BB-GT1540

Main menu	Sub-menu 1	Sub-menu 2	Page	
joip joip	joip service	–	75	
	joip message	–	74	
	My joip numbers	–	31	
	joip settings	DHCP ^{*1}		30
		IP settings ^{*1}		30
		joip MSG alert		75
Answer System 	Play New Msg.	–	62	
	Play All Msg.	–	62	
	To erase all ^{*1}	–	63	
	Settings	Number of Rings ^{*1}		66
		Recording Time ^{*1}		66
		Remote Code ^{*1}		64
		Call Screening ^{*1}		67
Ringer settings 	Ringer Volume	–	–	
	Ext. Ringtone (External ringtone)	–	54	
	Import ringtone	–	73	
	Interrupt tone	–	–	
	Ring colour	–	–	
	Night Mode	Start/End		58
		On/Off		58
		Ring Delay		59
Set Date & Time 	Set Date & Time ^{*1}	–	29	
	Alarm	–	55	
	Time Adjustment ^{*1}	–	–	

Programming

Main menu	Sub-menu 1	Sub-menu 2	Page	
Initial settings 	Dial lock ^{*1}	–	57	
	Auto Intercom	–	69	
	Contrast	–	–	
	Keytones	–	–	
	Auto Talk	–	33	
	New Msg. Alert	–	66, 68	
	IP/TEL select	–	29	
	Base Unit Setup	Interrupt tone ^{*1}	–	–
		Night Mode ^{*1*3}	–	58
		IP/TEL select ^{*1*2}	–	29
		Base Unit PIN ^{*1}	–	56
	Set phone line	Set recall time ^{*1}	57	57
	Registration	Register Handset	77	77
		Deregistration	77	77
Handset Name	–	56	56	
Calling Code	–	55	55	
Select Language	–	29	29	
Customer support 	Web site	–	52	
	Software version ^{*1}	–	57	

*1 If you program these settings using one of the handsets, you do not need to program the same item using another handset.

*2 BB-GT1540

*3 Night mode has “Start/End”, “On/Off” and “Ring Delay” sub-menus.

Programming using the direct commands

1  → [✚]

2 Enter the desired feature code.

3 Enter the desired setting code. → **OK**

- This step may vary depending on the feature being programmed.

4 [~~✚~~]

Note:

- In the following table, < > indicates the default setting.
- If you make a mistake or enter the wrong code, press [~~✚~~], then start again from step 1.

Feature	Feature code	Setting code	Page
Alarm	[7][2][0]	–	55
Auto Intercom	[2][7][3]	[1]: On (Ringer On) [2]: On (Ringer Off) [0]: <Off>	69
Auto Talk ^{*1}	[2][0][0]	[1]: On [0]: <Off>	33
Base Unit PIN ^{*2}	[1][3][2]	–	56
Contrast (Display contrast)	[1][4][5]	[1]-[6]: Level 1–6 <3>	–
Deregistration	[1][3][1]	–	77
Dial lock ^{*2}	[2][5][1]	–	57
Display Language	[1][1][0]	–	29
Ext. Ringtone (External ringtone) (Handset)	IP	[1][6][1][1]	[1]-[3]: Ringtone 1-3 [4]-[6]: Melody 1-3 [7]: Demo ^{*6} IP: <Ringtone 2> TEL: <Ringtone 1>
	TEL	[1][6][1][2]	
Handset Name	[1][0][4]	–	56
Interrupt tone ^{*3} (Handset)	[2][0][1]	[1]: <On> [0]: Off	–
Interrupt tone ^{*2*3} (BB-GT1520/ BB-GT1522/ BB-GT1540 base unit)	[*][2][0][1]		–
IP/TEL select (Handset)	[2][5][0]	[1]: IP [2]: <TEL>	29
IP/TEL select ^{*2} (BB-GT1540 base unit)	[*][2][5][0]		29

Feature		Feature code	Setting code	Page
Keytones ^{*4}		[1][6][5]	[1]: <On> [0]: Off	–
New Msg. Alert		[3][4][0]	[1]: On [0]: <Off>	66, 68
Night Mode ^{*5} (Handset)	Start/End	[2][3][7]	–	58
	On/Off	[2][3][8]	[1]: On [0]: <Off>	58
	Ring Delay	[2][3][9]	[1]: 30 sec. [2]: <60 sec.> [3]: 90 sec. [4]: 120 sec. [0]: No Ringing	59
Night Mode ^{*2*5} (BB-GT1520/ BB-GT1522/ BB-GT1540 base unit)	Start/End	[*][2][3][7]	–	58
	On/Off	[*][2][3][8]	[1]: On [0]: <Off>	58
	Ring Delay	[*][2][3][9]	[1]: 30 sec. [2]: <60 sec.> [3]: 90 sec. [4]: 120 sec. [0]: No Ringing	59
Register Handset		[1][3][0]	–	77
Ring colour (Ringer indicator colour)		[2][3][5]	[1]: <Colour1> [2]: Colour2 [3]: Colour3 [4]: Multicolour	–
Ringer Volume (Handset)	IP	[1][6][0][1]	[1]-[6]: Level 1–6 <6> [0]: Off	–
	TEL	[1][6][0][2]		
Set Date & Time ^{*2}		[1][0][1]	–	29
Web site ^{*7} (Customer support)		[6][8][0]	www.globarange.com	–

*1 If you subscribe to Caller ID service and want to view the caller's information after lifting up the handset to answer a call, turn off this feature.

*2 If you program these settings using one of the handsets, you do not need to program the same item using another handset.

*3 This tone lets you know when you receive a call while you are on the other line, on an intercom call, or monitoring a room. The tone sounds 2 times.

*4 Turn this feature off if you prefer not to hear key tones while you are dialling or pressing any keys, including confirmation tones and error tones.

*5 In order to set the night mode, you must first set the date and time (page 29).

*6 The preset song "Demo" in this product is used with the permission of © 2006 Copyrights Vision Inc.

*7 The handset can display the Internet address where you can get further information for this product using your computer.

For landline

Feature	Feature code	Setting code	Page
Calling Code	[2][5][9]	–	55
Set recall time ^{*1}	[1][2][1]	–	57
Time Adjustment ^{*1 *2} (Caller ID subscribers only)	[2][2][6]	[1]: <Caller ID[Auto]> [2]: Manual	–

*1 If you program these settings using one of the handsets, you do not need to program the same item using another handset.

*2 If the caller ID time and date display service is available in your area, this feature allows the unit to automatically adjust the date and time setting when caller information is received. To use this feature, set the date and time first.

For IP line

Feature	Feature code	Setting code	Page
DHCP ^{*1}	[5][0][0]	[1]: <On> [0]: Off	30
Import ringtone	[1][7][0]	–	73
IP settings ^{*1}	[5][0][1]	–	30
joip message	[3][6][0]	–	74
joip MSG alert (joip message alert)	[3][6][1]	[1]: <On> [0]: Off	75
joip service	[5][3][0]	–	75
My joip numbers	[1][0][3]	–	31
Software version ^{*1}	[7][2][4]	–	57

*1 If you program these settings using one of the handsets, you do not need to program the same item using another handset.

For the answering system (BB-GT1520/BB-GT1522/BB-GT1540)

Feature		Feature code	Setting code	Page
Call Screening ^{*1}		[3][1][0]	[1]: <On> [0]: Off	67
Number of Rings ^{*1}	IP	[2][1][1] → [1]	[2]-[7]: Rings	66
	TEL	[2][1][1] → [2]	<4 Rings> [0]: Toll saver ^{*2}	
Play All Msg. (All message playback)		[3][2][4]	–	62
Play New Msg. (New message playback)		[3][2][3]	–	62
Recording Time ^{*1}	IP	[3][0][5] → [1]	[1]: 1 Minutes	66
	TEL	[3][0][5] → [2]	[2]: 2 Minutes [3]: <3 Minutes>	
Remote Code ^{*1}		[3][0][6]	Default: Off	64
To erase all ^{*1} (Erasing all messages)		[3][2][5]	–	63

*1 If you program these settings using one of the handsets, you do not need to program the same item using another handset.

*2 **IP** Depending on the condition of your network connection, “Toll saver” may not be used for the IP line.

Adjusting the handset ringtone

You can change the ringtone heard when an outside call is received for each line. You can also assign the ringtone you have imported (page 73). The default setting for the IP line is “Ringtone 2” and for the TEL line is “Ringtone 1”.

- ☰** → [☎][1][6][1]
- ▼**/**▲**: Select the desired line.
- ▼**/**▲**: Select the desired setting.
- OK** → [↵]

Alarm

An alarm will sound for 3 minutes at the set time. Set the date and time beforehand (page 29).

1  → **[#][7][2][0]** → **OK**

2 **[v]/[▲]**: Select the desired alarm mode. → **OK**

Off	Turns alarm off. Go to step 5.
Once	The alarm sounds once at the set time. Enter the desired date.
Daily	An alarm sounds daily at the set time.

3 Set the desired time. → **OK**

4 **[v]/[▲]**: Select the desired ringtone. → **OK**

- We recommend selecting a ringtone different from the ringtone set for incoming calls.

5 **[v]/[▲]**: “Save” → **OK** → **[↶]**

Note:

- To stop the alarm, press any dial key or place the handset on the base unit or charger.
- When the handset is in use, the alarm will not sound until the handset enters standby mode.
- If you are on a call, beeps will sound and  will flash at the set time. The alarm will not sound until you hang up.
- If you select “Once”, the setting will change to “Off” after the alarm sounds.
- The ringer volume for the alarm follows the higher volume level of the 2 lines (page 52).
- When the ringer volume is set to off for both lines, the handset rings at the low level for alarm.

Calling code for the handset **TEL**

If you need to dial a special calling code to make calls using the telephone services of a certain service provider, you can store the calling code in advance and dial it by simply pressing and holding the **[*]** while dialling a phone number.

Important:

- To use this feature, you must store the calling code in advance.

Example:

- If you store the calling code “098” and press and hold **[*]** before dialling “12345”, the unit dials “09812345” automatically.

Assigning the calling code number

1  → **[#][2][5][9]**

2 Enter the desired calling code (24 digits max.). → **OK** → **[↶]**

Making calls using a calling code

When dialling manually:

- 1 Press and hold **[*]**.
 - The calling code you stored will be displayed.
- 2 Dial the phone number manually.
- 3 **[TEL]**
 - You can also make a call by pressing . The line set for line selection mode is automatically selected (page 29).

When dialling from the redial list, phonebook, or caller list:

- 1 Display the desired phone number in the redial list (page 32), phonebook (page 40), or caller list (page 45).
- 2 Press and hold **[*]**.
 - The calling code you stored will be displayed before the phone number.
- 3 **[TEL]**
 - You can also make a call by pressing . The line set for line selection mode is automatically selected (page 29).

Changing the base unit PIN (Personal Identification Number)

Important:

- If you change the PIN, please make note of your new PIN. The unit will not reveal the PIN to you. If you forget your PIN, see page 91.
- 1 → **[*][1][3][2]**
 - 2 Enter the current 4-digit base unit PIN (default: “0000”).
 - 3 Enter the new 4-digit base unit PIN.
 - 4 **OK** → **[*]**

Changing the handset name

Each handset can be given a customised name (“Bob”, “Kitchen”, etc.). This is useful when you make intercom calls between handsets. You can also select whether or not the handset name is displayed in standby mode. The default setting is “off”. If you select “on” without entering any handset name, “Handset 1” to “Handset 6” is displayed.

- 1 → **[*][1][0][4]**
- 2 Enter the desired name (max. 10 characters; see the character table, page 79).
 - If not required, go to step 3.
- 3 **OK**
- 4 **[v]/[▲]**: Select the desired setting. → **OK** → **[*]**

Setting the recall time

The recall time depends on your telephone exchange or host PBX. Consult your PBX supplier if necessary. The default setting is “100 millisecond”. The setting should stay at “100 millisecond” unless pressing [R] fails to pick up the call waiting call.

1  → [#][1][2][1]

2 [v]/[^]: Select the desired setting. → **OK** → [↶]

Updating the base unit software

joip may offer new features and improve its software version from time to time. If you set the base unit software update setting to manual mode at www.joip.com, you need to download the update when “Update version. Press OK.” is displayed on the handset.

Important:



- Make sure the  indicator is lit in green and the IP indicator is not lit on the base unit.

1 Press **OK** while “Update version. Press OK.” is displayed.

- The current and new base unit software versions are displayed.
- If you want to download the update later, press **X**. When you are ready to download, see “Confirming the base unit software version”, page 57.

2 **OK**

Note:

- The IP indicator and  indicator on the base unit flash while downloading. When the download is complete, the IP indicator goes out while the  indicator stops flashing and changes to steady green.

Confirming the base unit software version

1  → [#][7][2][4]

- The current base unit software version is displayed.

2 If “Update version?” is displayed, press **OK** to download. If not, press **X**.

Dial lock

This feature prohibits making outside calls. The default setting is “Off”.

Important:

- When dial lock is turned on, only phone numbers stored in the phonebook as emergency numbers (numbers stored with a # at the beginning of the name) can be dialled using the phonebook (page 40). We recommend storing emergency numbers in the phonebook before using this feature.
- When dial lock is turned on:
 - you cannot store, edit, or erase items in the phonebook
 - you cannot import those items to the handset (page 73)

To turn dial lock on

- 1  → **[*][2][5][1]**
- 2 Enter a 4-digit password.
 - This password is required when turning dial lock off. We recommend writing the password down.
- 3 Press **OK** 2 times. → **[*]**

To turn dial lock off

- 1  → **[*][2][5][1]**
- 2 Enter the same password that was entered when dial lock was turned on.
- 3 Press **OK** 2 times. → **[*]**

Note:



- If you forget the password, see page 91.

Night mode

Night mode allows you to select a block of time during which the handset or base unit will not ring for outside calls. This feature is useful for times when you do not want to be disturbed, for example, while sleeping. Night mode can be set independently for the handset and the base unit (page 58). Set the date and time beforehand (page 29).



Setting the start and end time for night mode

The default start time is “23 : 00”. The default end time is “06 : 00”.

- 1 **To set for the handset:**
 → **[*][2][3][7]**
To set for the base unit (BB-GT1520/BB-GT1522/BB-GT1540):
 → **[*][*][2][3][7]**
- 2 Enter the desired hour and minute you wish to start this feature.
- 3 Enter the desired hour and minute you wish to end this feature.
- 4 **OK** → **[*]**

Turning night mode on/off

The default setting is “OFF”.

- 1 **To set for the handset:**
 → **[*][2][3][8]**
To set for the base unit (BB-GT1520/BB-GT1522/BB-GT1540):
 → **[*][*][2][3][8]**
- 2 **[v]/[▲]**: Select the desired setting. → **OK** → **[*]**

Setting the ring delay for night mode

This setting allows the handset or base unit to ring during night mode if the caller waits long enough. After the selected amount of time passes, the unit will ring. If you select “No Ringing”, the unit will never ring during night mode. The default setting is “60 sec.”.

1 To set for the handset:

 → **[*][2][3][9]**

To set for the base unit (BB-GT1520/BB-GT1522/BB-GT1540):

 → **[*][*][2][3][9]**

2 **[v]/[^]**: Select the desired setting. → **OK** → **[*]**

Note:

- When the answering system answers the call, this feature does not work. (BB-GT1520/BB-GT1522/BB-GT1540)

Adjusting the base unit ringer volume (BB-GT1520/BB-GT1522/BB-GT1540)

1 Press **[IP/TEL]** repeatedly until the display shows the desired line (**[IP]** or **[TEL]**).

- You cannot set the ringer volume for both lines at the same time.

2 Press **[^]** or **[v]** repeatedly to select the desired volume.

- To turn the ringer off, press and hold **[v]** until the unit beeps.
- To stop ringing, press **[■]**.

Setting the base unit ringtone (BB-GT1520/BB-GT1522/BB-GT1540)

There are 3 tones and 3 melodies.

1 Press **[IP/TEL]** repeatedly until the display shows the desired line (**[IP]** or **[TEL]**).

- You cannot set the ringtone for both lines at the same time.

2 **[^]**

3 Within 10 seconds, press **[|<<|]** or **[|>>|]** repeatedly to select the desired tone.

- To stop ringing, press **[■]**.

Answering system

Available model:

BB-GT1520/BB-GT1522/BB-GT1540

This unit contains an answering system which can answer and record calls for you when you are unavailable to answer the phone.

Important:

- Only 1 person can access the answering system at a time.
- When callers leave messages, the unit records the day and time of each message. Make sure the date and time have been correctly set (page 29).

Memory capacity

The total recording capacity (including caller messages and voice memos) is about 45 minutes.

A maximum of 99 messages can be recorded.

- If the message memory becomes full, **[▶]** on the base unit flashes rapidly. Erase unnecessary messages (page 62).
- When the message memory becomes full, the greeting message is different depending on your situation:
 - If you use the pre-recorded greeting message, the unit automatically switches to another pre-recorded greeting message asking callers to call again later.
 - If you recorded your own greeting message, the same message is still announced to callers even though their messages are not recorded.

Turning the answering system on

- 1 Press **[IP/TEL]** repeatedly until the display shows the desired line(s) (**[IP]** and/or **[TEL]**).
- 2 Press **[☎]** to turn on the answering system.
 - The **[☎]** indicator lights.

Note:

- In standby mode, the display shows the line(s) set for the answering system (**[IP]** and/or **[TEL]**).

Turning the answering system off

Press **[☎]**.

- The **[☎]** indicator turns off.

Screening calls

While a caller is leaving a message, you can listen to the call through the base unit's speaker. To adjust the speaker volume, press **[V]** or **[^]** repeatedly.

- To answer the call using the base unit, press the flashing **[TEL]** or **[IP]**. (BB-GT1540)
- To answer the call using the handset, press **[TEL]** or **[IP]**.

Note:

- To turn this feature off, see page 67.

Greeting message

When the unit answers a call, callers are greeted by a greeting message. You can record your own greeting message or use a pre-recorded greeting message.

Recording your greeting message

You can record your own greeting message (max. 2 minutes) that is played when the answering system answers a call.

The greeting messages can be recorded:

- separately for either the IP line or landline.
- for both the IP line and landline using a common greeting.

If you do not record a greeting message, a pre-recorded greeting message is used.

- 1 Press **[IP/TEL]** repeatedly until the display shows the desired line(s) (**[IP]** and/or **[TEL]**).
- 2 **[☎●]**
- 3 Within 10 seconds, press **[☎●]** again.
- 4 After the base unit beeps, speak clearly about 20 cm away from the MIC.
- 5 To stop recording, press **[■]**.

Using a pre-recorded greeting message

If you erase or do not record your own greeting message, the unit plays a pre-recorded greeting message for callers and asks them to leave messages.

Playing back the greeting message

- 1 Press **[IP/TEL]** repeatedly until the display shows the desired line(s) (**[IP]** and/or **[TEL]**).
- 2 **[☎▶]**

Erasing your greeting message

- 1 Press **[IP/TEL]** repeatedly until the display shows the desired line(s) (**[IP]** and/or **[TEL]**).
- 2 Press **[☎▶]**, and then press **[X]** while your greeting message is playing.

Listening to messages using the base unit

When new messages have been recorded, **[▶]** on the base unit flashes. Press **[▶]** (centre of navigator key).

- The base unit plays new messages including voice memos.
- When you have no new messages, the base unit plays back all messages.

Playing back messages for the desired line(s)

- 1 Press **[IP/TEL]** repeatedly until the display shows the desired line(s) (**[IP]** and/or **[TEL]**).
- 2 Press **[▶]** (centre of navigator key).

Note:

- If you select the line(s), voice memos are not played (page 63).

Operating the answering system

Key	Operation
[^]/[v]	Adjust the speaker volume (during playback)
[◀◀]	Repeat a message (during playback)* ¹
[▶▶]	Skip a message (during playback)
[■]	Pause a message – To resume playback, press [▶] (centre of navigator key). – To stop playback completely, press [■] again.
[X]	Erase message currently playing

*1 If pressed within the first 5 seconds of a message, the previous message is played.

Erasing all messages

Press [X] 2 times while the unit is not being used.

- All messages including voice memos are erased.



Erasing all messages for the desired line(s)

- 1 Press [IP/TEL] repeatedly until the display shows the desired line(s) ([IP] and/or [TEL]).
- 2 Press [X] 2 times.

Listening to messages using the handset

When new messages have been recorded:

- “New message” is displayed.
- The message indicator on the handset flashes slowly if the message alert feature is turned on (page 66).

- 1  → 
 - The handset plays new messages including voice memos.
 - When you have no new messages, the handset plays back all messages.
- 2 When finished, press [↶].

Note:

- You can also listen to the messages as follows:

To play new messages:

 → [✱][3][2][3]



To play all messages:

 → [✱][3][2][4]

- To switch to the receiver, press [↶].

Calling back (Caller ID subscribers only)

If Caller ID information was received for the call, you can call the caller back while listening to the message.

- 1 Press **OK** during playback.
 - To edit the number before calling back, press . Then add or erase digits to the beginning of the number by pressing the desired dial key or **C**.
- 2 Press .
 - The indicated line is selected.
 - You can also select the line by pressing [TEL] or [IP].

Operating the answering system

You can also operate the answering system by pressing dial keys on the handset.

To use the following commands:

[#] → **[v]/[▲]**: "Answer System"
→ **OK**

Key	Operation
Pushing the joystick up or down.	Adjust the receiver/speaker volume (during playback)
[1] or push the joystick left	Repeat message (during playback) ^{*1}
[2] or push the joystick right	Skip message (during playback)
[3]	Enter the "Settings" menu
[4]	Play new messages
[5]	Play all messages
[9] / [■]	Stop playback
[0]	Turn answering system off
[*][4] / [X]	Erase message currently playing
[*][5]	Erase all messages
[#][1][8]	Turn answering system on for IP line only
[#][2][8]	Turn answering system on for landline only
[#][0][8]	Turn answering system on for both IP line and landline

*1 If pressed within the first 5 seconds of a message, the previous message is played.

Erasing all messages

1 **[#]** → **[#][3][2][5]**

2 **[v]/[▲]**: "Yes" → **OK**

- When all items have been erased, "Erased" is displayed.

3 **[X]**

Voice memo

Recording a voice memo

You can use the base unit to leave a voice memo (voice message) for yourself or someone else (max. 3 minutes). Voice memos can be played back later with the same operation used to play back answering system messages.

1 **[7]**

2 After the unit beeps, speak clearly about 20 cm away from the MIC.

3 To stop recording, press **[■]**.

Remote operation

Using a touch tone phone, you can call your phone number from outside and access the unit to listen to messages. The unit's voice guidance prompts you to press certain dial keys to perform different operations.

Important:

- In order to operate the answering system remotely, you must first turn on remote operation by setting a remote code (page 64). This code must be entered each time you operate the answering system remotely.
- To call the unit via the IP line from a landline phone or mobile phone, you need an additional phone number you subscribed at www.joip.com other than the joip number (page 4).

Turning remote operation on



A 3-digit remote code must be entered when operating the answering system remotely. This code prevents unauthorised parties from listening to your messages remotely. After you store your remote code, remote operation is possible. The default setting is "OFF".

- 1 → **[#][3][0][6]**
- 2 To turn on remote operation, enter a 3-digit remote code. Enter the desired 3-digit remote code.
 - To turn off remote operation, press **[*]**.
- 3 → **[↵]**

Note:

- If you have stored the remote code, you can turn on the answering system by calling the unit even when it is

turned off (page 60). This call may be answered before the ring delay feature of the night mode (page 59) activates. You need to select "30 sec." for activating the ring delay feature.

Using the answering system remotely

- 1 Dial your phone number from a touch tone phone.
- 2 After the greeting message starts, enter your remote code (page 64).
 - The unit plays back new messages.
- 3 Control the unit using remote commands (page 65).
- 4 When finished, hang up.

Note:

- When you press a key, press firmly.

Voice guidance

During remote operation, the unit's voice guidance starts and prompts you to press **[1]** to perform a specific operation, or press **[2]** to listen to more available operations. Operations are presented by voice guidance in the following order:

- Play back all messages
- Play back new messages
- Record your message
- Erase all messages
- Record your greeting message

Note:

- If you do not press any dial keys within 10 seconds after a voice guidance prompt, the unit disconnects your call.

Remote commands

You can press dial keys to access certain answering system functions without waiting for the voice guidance to prompt you.

Key	Operation
[1]	Repeat message (during playback)* ¹
[2]	Skip message (during playback)
[4]	Play new messages
[5]	Play all messages
[9]	Stop recording Stop playback* ²
[0]	Turn answering system off
[*][4]	Erase message currently playing
[*][5]	Erase all messages
[#][1][7]	Record a greeting message for IP line only.
[#][2][7]	Record a greeting message for landline only.
[#][0][7]	Record a common greeting message for both IP line and landline.
[#][1][8]	Turn answering system on for IP line only.
[#][2][8]	Turn answering system on for landline only.
[#][0][8]	Turn answering system on for both IP line and landline.
[*][#]	End remote operation (or hang up).

- *1 If pressed within the first 5 seconds of a message, the previous message is played.
- *2 To resume operation, enter a remote command within 15 seconds, or the voice guidance starts.

Turning on the answering system remotely

If the answering system is off, you can turn it on remotely by calling the selected line in "Turning the answering system on ", page 60.

- 1 Dial the phone number from a touch tone phone.
- 2 Let the phone ring 20 times.
 - A long beep will be heard.
- 3 Enter your remote access code within 10 seconds after the long beep.
 - The unit answers your call with the greeting message.
 - You can hang up, or enter your remote code again and begin remote operation (page 64).

Skipping the greeting message to leave a message

You can leave a message just as any outside caller can. Call your phone number. When the answering system picks up, press [*] to skip the greeting message and record your message after the beep.

Answering system settings

Number of rings

You can change the number of times the phone rings before the unit answers calls. The default setting is “4 Rings”. “**Toll saver**”^{*1}: The unit answers on the 2nd ring when new messages have been recorded, and on the 5th ring when there are no new messages. If you call your phone from outside to listen to new messages (page 64), you will know that there are no new messages when the phone rings for the 3rd time. You can then hang up without being charged for the call.

- 1  → [∗][2][1][1]
- 2 [▼]/[▲]: Select the desired line.
- 3 [▼]/[▲]: Select the desired setting.
- 4 **OK** → [↵]

*1  Depending on the condition of your network connection, “**Toll saver**” may not be used for the IP line.

For Voice Mail service subscribers

Please note the following:

- To use the Voice Mail service provided by your landline service provider/joip rather than the unit’s answering system, turn off the answering system (page 60).
- To use this unit’s answering system rather than the Voice Mail service, please contact your landline service provider/joip service provider to deactivate your Voice Mail service.

If your service provider cannot do this:

- Set this unit’s “**Number of Rings**” setting so that this unit’s

answering system answers calls before the Voice Mail service does. It is necessary to check the number of rings required to activate the Voice Mail service before changing this setting.

- Change the number of rings of the Voice Mail service so that the answering system can answer the call first. To do so, consult your landline service provider/joip service provider.

Caller’s recording time

You can change the maximum message recording time allotted to each caller. The default setting is “3 Minutes”.

- 1  → [∗][3][0][5]
- 2 [▼]/[▲]: Select the desired line.
- 3 [▼]/[▲]: Select the desired setting.
- 4 **OK** → [↵]

Message alert

You can select whether or not the message indicator on the handset flashes (slowly) when new messages are recorded. The default setting is “Off”.

Important:

- If there are new Voice Mail messages (page 68), the message indicator on the handset also flashes slowly.

- 1  → [∗][3][4][0]
- 2 [▼]/[▲]: Select the desired setting.
- 3 **OK** → [↵]

Note:

- While message alert feature is on, the battery operating time is shortened (page 22).

Call screening

This feature allows you to listen to a message from the base unit while the answering system is recording the message. The default setting is "On".

- 1  → [⊕][3][1][0]
- 2 [▼]/[▲]: Select the desired setting.
- 3 **OK** → [↵]

Using Voice Mail service

This unit is compatible with Voice Mail services offered by your landline service provider and joip. After you subscribe to these services, the Voice Mail system of your service provider will answer calls for you when you are unavailable to answer the phone or when your line is busy. Messages are recorded by your Voice Mail service provider, not your telephone.

- **TEL** Please contact your landline service provider for details.
- **IP** Please visit www.joip.com or contact the joip service provider for details.

Important:

- To use the Voice Mail service rather than the unit's answering system, turn off the answering system (page 60).

Voice Mail message indication **IP**

The unit lets you know that you have new Voice Mail messages in the following ways:

- The  indicator on the base unit flashes.
- “VoiceMail:joip” is displayed on the handset. “VoiceMail:joip” indicates the messages received by joip.
- The message indicator on the handset flashes slowly if the message alert feature is turned on (page 68).

To listen to your Voice Mail messages received by joip, access the joip Voice Mail from the joip service menu using the handset (page 75).

Note:

- If the handset or base unit still indicates there are new messages

even after you have listened to all new messages, turn it off by pressing and holding **[*]** on the handset until a beep sounds.

Message alert

You can select whether or not the message indicator on the handset flashes (slowly) when there are new recorded messages in the Voice Mail system. The default setting is “off”.

Important:

- If there are new messages in the answering system (page 60), the message indicator on the handset also flashes slowly. (BB-GT1520/BB-GT1522/BB-GT1540)

- 1  → **[*][3][4][0]**
- 2 **[v]/[^]**: Select the desired setting.
- 3 **OK** → **[*]**

Note:

- While message alert feature is on, the battery operating time is shortened (page 22).

Intercom features between handsets

Intercom calls

Intercom calls can be made between handsets.

Note:

- If you receive an outside call while talking on the intercom, the interrupt tone sounds. To answer the call, press **[TEL]** or **[IP]**. To turn the interrupt tone off, see page 51.
- When paging, the paged handset beeps for 1 minute.

Making an intercom call

- 1 **[INT]**
- 2 To page a handset, enter its extension number (**[1] – [6]**).
 - To stop paging, press **[*]**.
- 3 When you finish talking, press **[*]**.

Answering an intercom call

- 1 Press **[hook]** to answer the page.
- 2 When you finish talking, press **[*]**.

Note:

- The ringer volume for intercom calls follows the higher volume level of the 2 lines (page 52).
- When the ringer volume is set to off for both lines, the handset rings at a low level for intercom calls.

Transferring calls, conference calls

Outside calls can be transferred between 2 handsets. 2 handsets can have a conference call with an outside party.

- 1 During an outside call, press **[INT]** to put the call on hold.
- 2 To page a handset, enter its extension number (**[1] – [6]**).
- 3 Wait for the paged party to answer.
 - If the paged party does not answer, press **[TEL]** or **[IP]** to return to the outside call.
- 4 **To complete the transfer:**
Press **[*]**.
 - The outside call is being routed to the handset.**To make a conference call:**
Press **[v]**.
 - To leave the conference, press **[*]**. The other 2 parties can continue the conversation.
 - To put the outside call on hold, press **[hook]**. To resume the conference, press **[v]**.

Answering a transferred call

Press **[hook]** to answer the page.

- After the paging party disconnects, you can talk to the outside caller.

Auto intercom/Room monitor

This feature allows you to:

- answer an intercom call without pressing any buttons on the handset.
- listen to the sound in a room where the handset is located.

Turning auto intercom on/off



“off” (Default): Turns this feature off.

“On (Ringer On)”: When an intercom call is received, the handset rings 2 times then the speakerphone is automatically turned on.

“On (Ringer Off)”: When an intercom call is received, the handset does not ring and the speakerphone is automatically turned on. This allows you to easily monitor a baby’s room, for

Intercom Features

example, from different areas of the house.

- 1  → [Ⓜ][2][7][3]
- 2 [▼]/[▲]: Select the desired setting.
- 3  → [↵]

Note:

- Auto intercom cannot be used when:
 - your handset is receiving a transferred outside call.
 - all handsets are being paged by the base unit.

Answering an intercom call using auto intercom

- 1 When you are paged by another handset, speak into the microphone.
 - To switch to the receiver, press .
- 2 To end the intercom, press [↵].

Monitoring audio in a room

You can listen to the sound in a room where another handset is located.

Important:

- Before using this feature, set auto intercom on the destination handset to “On (Ringer Off)” to allow access by other handsets.
- 1 Call the destination handset (page 69).
 - You can listen to the audio.
 - 2 To mute your sound output, press  if necessary.
 - 3 Press [↵] to stop monitoring.

Intercom features between the handset and base unit

Available model:

BB-GT1520/BB-GT1522/BB-GT1540

Intercom calls

Intercom calls can be made between the handset and base unit.

Note:

- If you receive an outside call while talking on the intercom, the interrupt tone sounds. To answer the call:
 - press [TEL] or [IP] on the handset.
 - press [TEL] or [IP] on the base unit. (BB-GT1540)
- To turn the interrupt tone off, see page 51.
- When paging unit(s) for an intercom call, the paged unit(s) beeps for 1 minute.

Making an intercom call

Handset

- 1 [INT]
- 2 To page the base unit, press [0].
 - To stop paging, press [↵].
- 3 When you finish talking, press [↵].

Base unit

BB-GT1520/BB-GT1522

- 1 [📞]
 - All handsets beep for 1 minute.
 - To stop paging, press [📞].
- 2 When you finish talking, press [📞].

Note:

- You can locate a misplaced handset by paging it.

BB-GT1540

- 1 **[**])**
- 2 To page a specific handset, enter its extension number (**[1] – [6]**). To page all handsets, press **[0]** or wait for a few seconds.
 - The paged handset(s) beeps for 1 minute.
 - To stop paging, press **[**])**.
- 3 When you finish talking, press **[**])**.

Note:

- You can locate a misplaced handset by paging it.

Answering an intercom call**Handset**

- 1 Press  to answer the page.
- 2 When you finish talking, press **[**]**.

Base unit

- 1 Press **[**])** to answer the page.
- 2 When you finish talking, press **[**])**.

Note for handset and base unit:

- The ringer volume for intercom calls follows the higher volume level of the 2 lines (page 52, 59).
- When the ringer volume is set to off for both lines, the handset or base unit rings at a low level for intercom calls.

Answering an intercom call using auto intercom

Before using the auto intercom, turn auto intercom on (page 69).

Handset

- 1 When you are paged by the base unit, speak into the microphone.

- To switch to the receiver, press **[<=>]**.

- 2 To end the intercom, press **[**]**.

Monitoring audio in a room using auto intercom (BB-GT1540)**Base unit**

You can listen to the sound in a room where the handset is located using the auto intercom (page 69).

Important:

- Before using this feature, set auto intercom on the destination handset to “On (Ringer Off)” to allow access by the base unit (page 69).

- 1 Call the destination handset (page 71).
 - You can listen to the audio.
- 2 To mute your sound output, press **[M]** if necessary.
- 3 Press **[**])** to stop monitoring.

Transferring calls, conference calls (BB-GT1540)



Outside calls can be transferred between the handset and base unit. The handset and base unit can have a conference call with an outside party.

Handset

- 1 During an outside call, press **[INT]** to put the call on hold.
- 2 To page the base unit, press **[0]**.
- 3 Wait for the paged party to answer.
 - If the paged party does not answer, press **[TEL]** or **[IP]** to return to the outside call.
- 4 **To complete the transfer:** Press **[**]**.
 - The outside call is being routed to the base unit.

To make a conference call:

Press .

- To leave the conference, press . The other 2 parties can continue the conversation.
- To put the outside call on hold, press . To resume the conference, press .

Base unit

1 During an outside call, press  to put the call on hold.

2 To page a specific handset, enter its extension number (**[1]** – **[6]**).

To page all handsets, press **[0]** or wait for a few seconds.

- Even if you call all handsets, only the handset user who answers first can take the transferred call.

3 Wait for the paged party to answer.

- If the paged party does not answer, press  to return to the outside call.



4 To complete the transfer:

Press .

- The outside call is being routed to the handset.

To make a conference call:

Press .

- To leave the conference, press . The other 2 parties can continue the conversation.
- To put the outside call on hold, press . To resume the conference, press .

Note for handset and base unit:

- After the paging party disconnects, you can talk to the outside caller.

Answering a transferred call

Handset

Press  to answer the page.

Base unit

Press  to answer the page.

Using joip service features

joip service offers not only IP phone features but other various features such as ringtones, text messages, community directory, and more. For further information, visit the joip website at www.joip.com

Importing downloaded phonebook items to the handset

You can add and edit phonebook items by accessing your account on the joip website (www.joip.com), then downloading your web phonebook to the base unit.

“New phonebook” is displayed after new phonebook items are downloaded. Import them to a handset.

- 1  → 
- 2 **[▼]/[▲]**: “Import phonebook”
- 3 **OK**

Note:

- “New phonebook” disappears from all handsets’ displays after the handset imported the phonebook items. Other handset users can import the phonebook items separately.

Importing downloaded ringtones to the handset

You can download a maximum of 3 ringtones to the base unit using the joip website (www.joip.com). After new ringtones are downloaded, “New ringer” is displayed on the handset. You can import these ringtones to the handset. A maximum of 3 imported ringtones can be stored in a handset at

one time. You can also set them as the handset ringer(s).

- 1  → **[#][1][7][0]**
- 2 **[▼]/[▲]**: Select the desired ringtone.
- 3 **OK**
 - “Receiving” is displayed on the handset while importing.
 - When the item has been imported, “Completed” is displayed.
- 4 To assign the ringtone to a line: **[▼]/[▲]**: “Yes” → **OK**
Not to assign the ringtone to a line: **[▼]/[▲]**: “No” → **OK** → Go to step 6.
- 5 **[▼]/[▲]**: Select the desired line.
 - To import other ringtones, repeat from step 2.
- 6 **[↶]**

Note:

- “New ringer” disappears from all handset displays after step 1. Other handset users can import the ringtones separately.
- To assign a ringtone to a line later, see page 54.
- To use a ringtone for a ringer ID of a handset phonebook item, see page 40, 41.
- To use a ringtone for the alarm, see page 55.
- In step 3, if “Overwrite?” is displayed, 3 ringtones have already been imported. To overwrite with the new one, select a ringtone you do not need. → **OK**
- If the overwritten ringtone was used for:
 - a handset ringer, “Ringtone 1” (landline) or “Ringtone 2” (IP line) is used instead

- a ringer ID of a handset phonebook item, the ringer set on page 54 is used instead
- the alarm, "Ringtone 1" is used instead
- Downloaded ringtones are temporarily stored in the base unit. When a 4th ringtone is downloaded to the base unit, it replaces the oldest one. All ringtones will be erased by pressing **[IP RESET]** (page 78).

joip text messages

You can view the joip text messages using a handset.

The unit can receive a maximum of 88 messages. The number of received messages may decrease depending on the size of each message as follows:

Size of message	Maximum number of messages
320 characters* ¹	14
12 or less characters	88

*1 The maximum number of characters per message

Note:



- The unit erases the oldest message when the message memory is full. We recommend you protect the messages you want to keep (page 74).

Viewing joip text messages

When new text messages have been received:

- "New joip message" is displayed if the joip text message alert is on (page 75).
- The message indicator on the handset also flashes slowly if both the joip text message alert and the message alert

for the Voice Mail or answering system are on (page 66, 68).

- 1  → **[#][3][6][0]**
 - The numbers of the new messages and total messages are displayed.
- 2 **[v]/[▲]**: Select the desired item.
→ **OK**
 - To view another text message, press  and repeat step 2.
- 3 **[↶]**

Note:

- A ✓ is displayed in the message list for a message which has already been viewed by any handset.
- If an arrow (▶) is displayed, some information is not shown. Push the joystick right to see the remaining information. To return to the previous display, push the joystick left.
- "New joip message" disappears from all handset displays after viewing all new joip text messages.

Protecting a joip text message

You can protect a maximum of 8 messages. When the message memory is full, protected messages are not erased until you release the protection. Press  while viewing a message.

- To release the protection, press  again.

Erasing a joip text message

- 1 While viewing the message list or message, press .
- 2 **[v]/[▲]**: "Yes"
- 3 **OK** → **[↶]**

Erasing all joip text messages

You can erase all text messages except protected messages (page 74).

- 1  → **[#][3][6][0]**

- 2 While viewing the number of the total text messages, press **X**.
- 3 **[v]/[▲]**: "Yes"
- 4 **OK** → **[↵]**

Turning the joip text message alert on/off

You can select whether or not "New joip message" is displayed on the handset when new joip messages have been received. The default setting is "On".

- 1 **[☰]** → **[#][3][6][1]**
- 2 **[v]/[▲]**: Select the desired setting.
- 3 **OK** → **[↵]**

"joip service" menu

Some joip services such as Voice Mail can be accessed from the "joip service" menu using the handset. This menu can be downloaded from joip. Select the desired service from the "joip service" menu. The access number is automatically dialed via the IP line. For further information about the services, visit www.joip.com

- 1 **[☰]** → **[#][5][3][0]**
 - The available menu is displayed.
- 2 **[v]/[▲]**: Select the desired item. → **OK**
 - The unit dials to access the service.
- 3 When finished, press **[↵]**.

Belt clip

You can hang the handset on your belt or pocket using the supplied belt clip.

To attach the belt clip

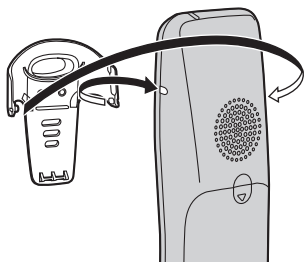

To remove the belt clip

While pressing the top of the clip (1), pull the right edge in the direction of the arrow (2).

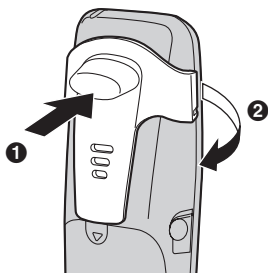

Wall mounting for charger

Available model:

BB-GT1522

- 1 Drive the screws (not supplied) into the wall.

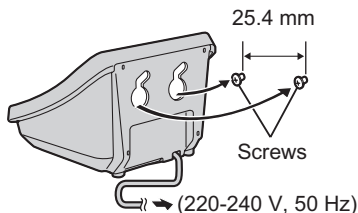

- 2 Mount the charger (1), then slide it down (2) and to the right (3) until it is secure.

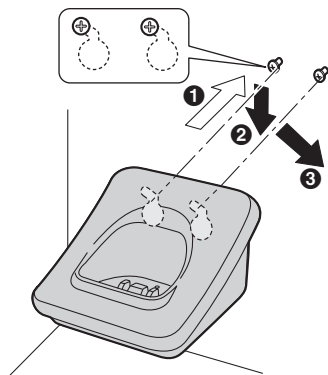

Registering a handset

The supplied handset and base unit are pre-registered. If for some reason the handset is not registered to the base unit, register the handset.

Important:

- If you have already deregistered the handset, perform steps 2 and 3 only.

1 Handset:

 → **[#][1][3][0]**

2 Base unit:

BB-GT1500

Press and hold **[📞]** until the  indicator flashes in red.

BB-GT1520/BB-GT1522/BB-GT1540



Press and hold **[📞]** until the registration tone sounds and the  indicator flashes in red.

- If all registered handsets start ringing, stop ringing by pressing the same button. Then repeat this step.
- After the  indicator starts flashing in red, the rest of the procedure must be completed within 90 seconds.

3 Handset:

OK 

4 Wait until “Enter Base PIN” is displayed, then enter the base unit PIN (default: “0000”), then press **OK**.

- If you forget your PIN, see page 91.
- When the handset has been registered successfully,  will change to . If the keytone is turned on (page 52), a confirmation tone will be heard.

Registering an additional handset

See page 9 for information on the available model. Start from step 2.

Deregistering a handset

Handset

1  → **[#][1][3][1]**

2 **[3][3][5]** → **OK**

3 **[▼]/[▲]**: Select the handset you want to cancel. → **OK**

4 **[▼]/[▲]**: “Yes” → **OK**

- When you cancel a different handset than the one you are now using, press **[🔍]** to exit.

Base unit

BB-GT1540

1 Press and hold **[📞]** until the registration tone sounds, and the  indicator flashes in red.

2 Press and hold the handset number (**[1]** - **[6]**) that you want to cancel until a confirmation tone sounds.

IP RESET button

Using the **[IP RESET]** button on the bottom of the base unit, you can reset the Internet connection settings.

- DHCP connection mode is returned to "On" (default).
- If you set the static IP address and other settings ("Subnet mask", "Default gateway", "DNS1", "DNS2"), they are erased.
- The Terms of Use for the joip services you previously agreed to is cancelled. You need to agree to it again using the handset.

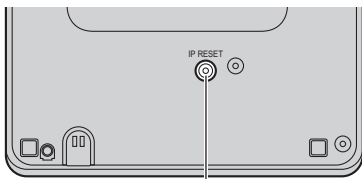

[IP RESET]

- 1 Make sure that the AC adaptor is connected.
Press and hold **[IP RESET]** for about 7 seconds with a pointed object such as a pen.
- 2 "Please read joip Terms of Use. Agree?" is displayed on the handset. Read the Terms of Use for the joip services on the supplied leaflet or at www.joip.com and press **OK**.
- 3 Wait until the  indicator turns green.
 - If necessary, set the Internet connection settings again (page 30).

Note:

- Ringtones and phonebook data downloaded from the joip website

(www.joip.com) to the base unit are erased. If necessary, import ringtones and phonebook data to the handset before pressing **[IP RESET]** (page 73).

- joip text messages are not affected.
- Entries in the handset phonebook, caller list, and redial list are not affected.
- The unit's settings (excluding internet connection settings) are not reset to default.

Character entry

The dial keys are used to enter characters and numbers. Each dial key has multiple characters assigned to it. The available character entry modes are Alphabet (ABC), Numeric (0-9), Greek (ABΓ), Extended 1 (AÄÅ), Extended 2 (ŠŠŠ), and Cyrillic (АБВ). When in these entry modes except Numeric, you can select which character is entered by pressing a dial key repeatedly.

- Use the joystick to move the cursor.
- Press dial keys to enter characters and numbers.
- Press **C** to erase the character or number highlighted by the cursor. Press and hold **C** to erase all characters or numbers.
- Press **[*]** to switch between uppercase and lowercase.
- To enter another character located on the same dial key, push the joystick right to move the cursor to the next space, then press the appropriate dial key.

Character entry modes

Several character entry modes can be used when entering text. The characters that can be entered depend on the entry mode.

Characters available in each character entry mode

When a character entry screen is displayed on the handset:

1/A/? → Select a character entry mode. → **OK**

Alphabet character table (ABC)

0	1	ABC 2	DEF 3	GHI 4	JKL 5	MNO 6	PQRS 7	TUV 8	WXYZ 9	#
Space 0	# & ' () * , - . / 1	A B C 2	D E F 3	G H I 4	J K L 5	M N O 6	P Q R S 7	T U V 8	W X Y Z 9	#
		a b c 2	d e f 3	g h i 4	j k l 5	m n o 6	p q r s 7	t u v 8	w x y z 9	

Numeric entry table (0-9)

0	1	ABC 2	DEF 3	GHI 4	JKL 5	MNO 6	PQRS 7	TUV 8	WXYZ 9	#
0	1	2	3	4	5	6	7	8	9	#

Greek character table (ABΓ)

0	1	ABC 2	DEF 3	GHI 4	JKL 5	MNO 6	PQRS 7	TUV 8	WXYZ 9	#
Space 0	# & ' () * , - . / 1	A B Γ 2	Δ E Z 3	H Θ I 4	K Λ M 5	N Ξ O 6	Π Ρ Σ 7	T Υ Φ 8	X Ψ Ω ð 9	#

Useful Information

Extended 1 character table (AÄÅ)

0	1	ABC 2	DEF 3	GHI 4	JKL 5	MNO 6	PQRS 7	TUV 8	WXYZ 9	#
Space 0	# & ' () * , - . / 1	A Ä Å Å Ä Å Å Æ B C Ç 2	D E Ę É Ê Ë Ë F 3	G Ğ H I Ì Í Î Ï 4	J K L 5	M N Ñ O Ò Ó Ô Õ Ö Ø 6	P Q R S Ş ß 7	T U Û Ú Ü Ü Û V 8	W Ŵ X Y Ŷ Z 9	#
		a á ä â ã ä å æ b ç ç 2	d e è é ê ë ë f 3	g ğ h i ì í î ï 4	j k l 5	m n ñ o ò ó ô õ ö ø 6	p q r s ş ß 7	t u ù ú û ü ü v 8	w ŵ x y ŷ z 9	

Extended 2 character table (ŠŠš)

0	1	ABC 2	DEF 3	GHI 4	JKL 5	MNO 6	PQRS 7	TUV 8	WXYZ 9	#
Space 0	# & ' () * , - . / 1	A Ā Ą Ą B C Ć Ć 2	D Ę E É Ę Ę F 3	G H I Í 4	J K L Ł Ł Ł 5	M N Ń Ń O Ó Ö Ö 6	P Q R Ŕ Ŕ S Š Š 7	T Ť U Ú Ů Ů Ů V 8	W X Y Ÿ Ý Z Ž Ž Ž 9	#
		a á ä ą b c ć ć 2	d ě e é ę ę f 3	g h i í 4	j k l ł í ł 5	m n ń ń o ó ö ö 6	p q r ŕ ŕ s š š 7	t ť u ú ú ů ů ů v 8	w x y ÿ ý z ž ž ž 9	

Cyrillic character table (АБВ)

0	1	ABC 2	DEF 3	GHI 4	JKL 5	MNO 6	PQRS 7	TUV 8	WXYZ 9	#
Space 0 ģ ė ĩ ĩ ŷ	# & ' () * , - . / 1	А Б В Г 2	Д Е Ж З 3	И Й К Л 4	М Н О П 5	Р С Т У 6	Ф Х Ц Ч 7	Ш Щ Ъ Ы 8	Ь Э Ю Я 9	#
Space 0 ģ ė ĩ ĩ ŷ		а б в г 2	д е ж з 3	и й к л 4	м н о п 5	р с т у 6	ф х ц ч 7	ш щ ъ ы 8	ь э ю я 9	

Error messages

If the unit detects a problem, one of the following messages is shown on the handset display.

Display message	Cause/solution
<p>Busy</p>	<ul style="list-style-type: none"> • The called handset or base unit is in use. • Privacy mode is on for the call you tried to join (page 34). • Other units are in use and the system is busy. Try again later. • The line is in use. Wait until IP or TEL disappears from the handset display.
<p>Free calls! Plug internet cable. www.joip.com</p>	<ul style="list-style-type: none"> • Confirm the Ethernet cable is properly connected (page 18). • Check the base unit's IP address using the handset: [#] → [⊞][5][0][1] If necessary, change the base unit's static IP address (page 30). • Check your network devices' (router, modem, etc.) connections. If the connections are made properly but the problem persists, check your network devices' (router, modem, etc.) settings. • If you cannot access Internet Web pages using your computer, check to see if your Internet service provider is having connection issues in your area. • Check your device connections with the installation instructions (page 18). The order in which you turn on the devices is important. • Many installation issues can be resolved by resetting all the equipment. First, shut down your modem, router, base unit, and computer. Then turn the devices back on one at a time in this order: modem, router, base unit, computer. • For more troubleshooting help, visit www.joip.com or contact the joip service provider. • You have not received the joip number. Install the base unit to your local network (page 18, 30).

Display message	Cause/solution
Dial locked	<ul style="list-style-type: none"> • Dial lock is turned on. To turn it off, see page 58.
Error	<ul style="list-style-type: none"> • The software update of the base unit has failed. Confirm that the IP line is not being used, and try again (page 57). • The entered password was wrong in programming dial lock. Enter the correct password.
Failed	<ul style="list-style-type: none"> • The handset you tried to copy phonebook items to is in use. • The handset you tried to copy phonebook items to is out of area.
Incomplete	<ul style="list-style-type: none"> • The destination handset's phonebook memory is full. Erase unnecessary items from the destination handset's phonebook (page 41).
Invalid setting	<ul style="list-style-type: none"> • The Internet connection settings are not correct. Enter the correct settings (page 30).
joip message Memory Empty	<ul style="list-style-type: none"> • There are no joip text messages (page 74).
Memory Full ^{*1}	<ul style="list-style-type: none"> • The message memory for the answering system is full. Erase unnecessary messages (page 62).
Memory full. Memory limited to 8 MSGs.	<ul style="list-style-type: none"> • The maximum number of joip text messages you can protect is 8. To release a protected text message, see page 74.
Memory Empty	<ul style="list-style-type: none"> • Your phonebook or redial list is empty. • There is no downloaded data (phonebook data, ringtone data, or joip service menu data) in the base unit. • The unit is not registered to the joip service. Check the connections (page 18) and confirm the  indicator lights in green (page 23).
Messages full ^{*1}	<ul style="list-style-type: none"> • The message memory for the answering system is full. Erase unnecessary messages (page 62).

Display message	Cause/solution
No link to base. Move closer to base, try again.	<ul style="list-style-type: none"> ● The handset has lost communication with the base unit. Move closer to the base unit, and try again. ● Unplug the base unit's AC adaptor to reset the unit. Reconnect the adaptor and try again. ● The handset's registration may have been cancelled. Re-register the handset (page 77).
Phonebook Memory Full	<ul style="list-style-type: none"> ● There is no space to store new items in the phonebook. Erase unnecessary items (page 41).
Please hang up and try again.	<ul style="list-style-type: none"> ● A handset button was pressed while the handset was on the base unit or charger. Lift the handset and press the button again.
Please read joip Terms of Use. Agree?	<ul style="list-style-type: none"> ● You have not agreed to the Terms of Use for the joip services. To use the joip IP line, you need to agree to it using the handset (page 19).
This message is not erasable.	<ul style="list-style-type: none"> ● The protected messages remain. All other messages are erased.
This message contains invalid characters.	<ul style="list-style-type: none"> ● The characters the unit cannot recognise are replaced with “_”.

*1 BB-GT1520/BB-GT1522/BB-GT1540

Troubleshooting

General use

Problem	Cause/solution
The unit does not work.	<ul style="list-style-type: none"> ● Make sure the battery is installed correctly and fully charged (page 19, 21). ● Check the connections (page 18). ● Unplug the base unit's AC adaptor to reset the unit. Reconnect the adaptor and try again. ● The handset has not been registered to the base unit. Register the handset (page 77).
<p>IP I cannot hear a dial tone for the IP line.</p>	<ul style="list-style-type: none"> ● Confirm the Ethernet cable is properly connected (page 18). ● You have not agreed to the Terms of Use for the joip services. To use the joip IP line, you need to agree to it using the handset (page 19). ● Check the base unit's IP address using the handset:  → 【#】【5】【0】【1】 If necessary, change the base unit's static IP address (page 30). ● Check your network devices' (router, modem, etc.) connections. If the connections are made properly but the problem persists, check your network devices' (router, modem, etc.) settings. ● Many installation issues can be resolved by resetting all the equipment. First, shut down your modem, router, base unit, and computer. Then turn the devices back on one at a time in this order: modem, router, base unit, computer. ● If you cannot access Internet Web pages using your computer, check to see if your Internet service provider is having connection issues in your area. ● For more troubleshooting help, visit www.joip.com or contact the joip service provider.

Problem	Cause/solution
<p>TEL I cannot hear a dial tone for the landline.</p>	<ul style="list-style-type: none"> ● Confirm the telephone line cord is properly connected (page 18). ● Disconnect the unit from the telephone line and connect a known working telephone. If the working telephone operates properly, contact Panasonic service personnel to have the unit repaired. If the working telephone does not operate properly, contact your landline service provider.
<p>The indicator on the top right of the handset flashes slowly.</p>	<ul style="list-style-type: none"> ● New messages have been received. Listen to the new messages (page 61).^{*1} ● IP New Voice Mail messages have been recorded. Listen to the new Voice Mail messages, see page 68. ● New joip text messages have been received. To view the text messages, see page 74.
<p>I have changed the display language to a language I cannot read.</p>	<ul style="list-style-type: none"> ● Change the display language (page 29).

*1 BB-GT1520/BB-GT1522/BB-GT1540

□ (Status) indicator



Problem	Cause/solution
<p>The □ indicator continues flashing in amber.</p>	<ul style="list-style-type: none"> ● An IP address may not have been acquired or the static IP address is not appropriate. Check the base unit's IP address using the handset: ☎ → [⊕][5][0][1] <ul style="list-style-type: none"> – If necessary, change the base unit's static IP address (page 30). – If an IP address was not acquired, check your network devices' (router, modem, etc.) connections. If the connections are made properly but the problem persists, check your network devices' (router, modem, etc.) settings. ● Many installation issues can be resolved by resetting all the equipment. First, shut down your modem, router, base unit, and computer. Then turn the devices back on one at a time in this order: modem, router, base unit, computer. ● If you cannot access Internet Web pages using your computer, check to see if your Internet service provider is having connection issues in your area. ● For more troubleshooting help, visit www.joip.com or contact the joip service provider.
<p>The □ indicator flashes in amber rapidly although the IP address was acquired.</p>	<ul style="list-style-type: none"> ● Unplug the base unit's AC adaptor to reset the unit, then reconnect the AC adaptor. If the □ indicator is still flashing in amber rapidly, there may be a problem with the base unit hardware. Contact Panasonic service personnel.
<p>The □ indicator lights in amber although the Ethernet cable is connected properly.</p>	<ul style="list-style-type: none"> ● The base unit's IP address may conflict with the IP addresses of other devices on your local network. Check the base unit's static IP address using the handset: ☎ → [⊕][5][0][1], then check the IP addresses of the other devices on your local network. If necessary, change the base unit's static IP address (page 30).

Problem	Cause/solution
The  indicator is off.	<ul style="list-style-type: none"> • The power of the base unit is off. • You have not agreed to the Terms of Use for the joip services. To use the joip IP line, you need to agree to it using the handset (page 19). • The Ethernet cable is not connected properly. Connect it. • Your network devices (hub, router, etc.) are turned off. Check the LEDs for the link status of the devices.

Programmable settings

Problem	Cause/solution
I cannot program items.	<ul style="list-style-type: none"> • Programming is not possible while either another handset or the base unit is being used. Try again later. • Programming is not possible while the base unit is downloading data from the joip service. Wait until the  indicator stops flashing and lights in steady green.
While programming, the handset starts to ring.	<ul style="list-style-type: none"> • A call is being received. Answer the call and start again after hanging up.
I cannot register a handset to a base unit.	<ul style="list-style-type: none"> • The maximum number of handsets (6) are already registered to the base unit. Cancel unused handset registrations from the base unit (page 77). • You entered the wrong PIN number. If you forget your PIN, see page 91. • Place the handset and the base unit away from other electrical appliances.

Battery recharge

Problem	Cause/solution
I fully charged the battery, but  continues to flash, or  is displayed.	<ul style="list-style-type: none"> • Clean the charge contacts and charge again (page 21). • The battery may need to be replaced with new ones (page 22).
The handset display is blank.	<ul style="list-style-type: none"> • Confirm that the battery are properly installed. • Fully charge the battery (page 21).

Making/answering calls, intercom

Problem	Cause/solution
Y is displayed, but I cannot make a call.	<ul style="list-style-type: none">● The handset and base unit could not communicate for some reason, such as interference from other electrical appliances. Perform the following:<ul style="list-style-type: none">– Move the handset and base unit away from other electrical appliances such as antennas and mobile phones.– Move closer to the base unit.
Static is heard, sound cuts in and out. Interference from other electrical units.	<ul style="list-style-type: none">● Move the handset and base unit away from other electrical appliances.● Move closer to the base unit.● TEL Your unit is connected to a landline with DSL service. We recommend connecting a filter (contact your DSL service provider) to the telephone line between the base unit and the telephone line jack.
The handset does not ring.	<ul style="list-style-type: none">● The ringer volume is turned off. Adjust it (page 52).● The night mode feature is turned on. To turn it off, see page 58.
The base unit does not ring.*1	<ul style="list-style-type: none">● The ringer volume is turned off. Adjust it (page 59).● The night mode feature is turned on. To turn it off, see page 58.
I cannot make a call.	<ul style="list-style-type: none">● IP Check if the <input type="checkbox"/> indicator is lit in green. If it is not lit in green, see “<input type="checkbox"/> (Status) indicator” (page 86).● IP You cannot make a call while the base unit is downloading the software update. Wait until the <input type="checkbox"/> indicator stops flashing and changes to steady green.● You may have selected the wrong line by pressing [TEL] or [IP]. Select the appropriate line to call the phone number.● The base unit or another handset is in use. Try again later.● Dial lock is turned on. To turn it off, see page 58.

Problem	Cause/solution
IP I cannot make a call using a mobile phone.* ¹	<ul style="list-style-type: none"> The IP line or the answering system is in use. Try again later. The remote code of the answering system is the default setting. You need to set your own remote code for security (page 64).
I cannot page the handset.	<ul style="list-style-type: none"> The paged handset is too far from the base unit. The paged handset is in use. Try again later.
I cannot page the base unit.* ¹	<ul style="list-style-type: none"> The base unit is in use. Try again later.
IP I answered a call when the phone rang, but the call was disconnected.	<ul style="list-style-type: none"> The ringer may continue to sound for several seconds after the caller hangs up because of the time lag of the signal transmission.
IP During a conversation, the following occurs: – noise is heard. – the sound is interrupted. – the sound is delayed.	<ul style="list-style-type: none"> It may be caused by someone using a computer connected to the same network as the unit. Confirm the speed of Internet connection. The unit requires 100 kbps for each upstream and downstream. If less than 100 kbps is provided, visit www.joip.com or contact the joip service provider.



*1 BB-GT1520/BB-GT1522/BB-GT1540

Caller ID

Problem	Cause/solution
The handset does not display the caller information.	<ul style="list-style-type: none"> You have not subscribed to Caller ID. <ul style="list-style-type: none"> TEL Contact your landline service provider to subscribe. IP Visit www.joip.com or contact the joip service provider to subscribe. The caller requested not to send caller information (page 44). TEL Generally, caller information is displayed from the 2nd ring. TEL Your unit is connected to a landline with DSL service. We recommend connecting a filter (contact your DSL service provider) to the telephone line between the base unit and the telephone line jack. TEL Other telephone equipment may be interfering with this unit. Disconnect the other equipment and try again.

Problem	Cause/solution
I cannot access the caller list.	<ul style="list-style-type: none"> Someone is viewing the caller list from another handset.

joip service features

Problem	Cause/solution
I cannot import phonebook data or ringtone data to the handset.	<ul style="list-style-type: none"> While the base unit is downloading data excluding the base unit software, you cannot import phonebook data or ringtone data to the handset. Wait until the  indicator stops flashing and lights in steady green.
I cannot view the joip text message.	<ul style="list-style-type: none"> Someone is viewing a joip text message from another handset. While the base unit is downloading data excluding the base unit software, you cannot view the joip text message. Wait until the  indicator stops flashing and lights in steady green.

Answering system (BB-GT1520/BB-GT1522/BB-GT1540)



Problem	Cause/solution
I cannot listen to messages from a remote location.	<ul style="list-style-type: none"> A touch tone phone is required for remote operation. Enter the remote code correctly and press each key firmly (page 64). The answering system is off. Turn it on (page 65).
The unit does not record new messages.	<ul style="list-style-type: none"> The answering system is not turned on for the line you wish to record messages from. Select the desired line or both lines by pressing [IP/TEL] on the base unit repeatedly, then turn the answering system on (page 60, 65). The message memory is full. Erase unnecessary messages (page 62, 63). The answering system is activated for both lines, and the 1st caller is leaving a voice message. The 2nd caller cannot leave a message, but the caller information will be stored (page 45). If you subscribe to the Voice Mail service, messages are recorded by the landline service provider/joip not your telephone (page 66).

Problem	Cause/solution
I cannot operate the answering system.	<ul style="list-style-type: none"> Someone is operating the answering system. If someone is talking on a conference call, you may not be able to operate the answering system. Try again later.

Dial lock/Base unit PIN

Important:

- Anyone can turn off the dial lock/base unit PIN using the following method. Be sure to keep these Operating Instructions in a safe place in order to prevent unauthorised persons from using your phone without permission.

Problem	Cause/solution
I cannot remember the dial lock password.	<ul style="list-style-type: none"> Turn the dial lock off using the following method. <ol style="list-style-type: none">  → [#][2][5][1] Press [*][7][0][0][0]. Press OK 2 times. → [ → [#][1][3][2] Press [*][7][0][0][0]. Enter the new 4-digit base unit PIN. → OK → [Download from www.manuals.com or visit www.globeorange.com and Download.

Open Source Software

Parts of this product use Open Source Software. Relevant conditions apply to this software. Panasonic cannot accept inquiries regarding the content of the following copyright and license information.

<<NetBSD kernel>>

This product uses a part of NetBSD kernel.

The use of a part of NetBSD kernel is based on the typical BSD style license below.

Copyright (c)

The Regents of the University of California. All rights reserved.

Redistribution and use in source and binary forms, with or without modification, are permitted provided that the following conditions are met:

1. Redistributions of source code must retain the above copyright notice, this list of conditions and the following disclaimer.
2. Redistributions in binary form must reproduce the above copyright notice, this list of conditions and the following disclaimer in the documentation and/or other materials provided with the distribution.
3. All advertising materials mentioning features or use of this software must display the following acknowledgement:
This product includes software developed by the University of California, Berkeley and its contributors.
4. Neither the name of the University nor the names of its contributors may be used to endorse or promote products derived from this software without specific prior written permission.

THIS SOFTWARE IS PROVIDED BY THE REGENTS AND CONTRIBUTORS
"AS IS" AND
ANY EXPRESS OR IMPLIED WARRANTIES, INCLUDING, BUT NOT LIMITED
TO, THE
IMPLIED WARRANTIES OF MERCHANTABILITY AND FITNESS FOR A
PARTICULAR PURPOSE
ARE DISCLAIMED. IN NO EVENT SHALL THE REGENTS OR CONTRIBUTORS
BE LIABLE
FOR ANY DIRECT, INDIRECT, INCIDENTAL, SPECIAL, EXEMPLARY, OR
CONSEQUENTIAL
DAMAGES (INCLUDING, BUT NOT LIMITED TO, PROCUREMENT OF
SUBSTITUTE GOODS
OR SERVICES; LOSS OF USE, DATA, OR PROFITS; OR BUSINESS
INTERRUPTION)
HOWEVER CAUSED AND ON ANY THEORY OF LIABILITY, WHETHER IN
CONTRACT, STRICT
LIABILITY, OR TORT (INCLUDING NEGLIGENCE OR OTHERWISE) ARISING IN
ANY WAY

OUT OF THE USE OF THIS SOFTWARE, EVEN IF ADVISED OF THE
POSSIBILITY
OF SUCH DAMAGE.

However, parts of the NetBSD Kernel are provided with the following copyright notices.

Copyright (c) 1980, 1983, 1988, 1993 The Regents of the University of California. All rights reserved.

Copyright (c) 1980, 1986, 1989, 1993 The Regents of the University of California. All rights reserved.

Copyright (c) 1980, 1986, 1991, 1993 The Regents of the University of California. All rights reserved.

Copyright (c) 1980, 1986, 1993 The Regents of the University of California. All rights reserved.

Copyright (c) 1982, 1985, 1986, 1988, 1993, 1994 The Regents of the University of California. All rights reserved.

Copyright (c) 1982, 1986, 1988, 1990, 1993 The Regents of the University of California. All rights reserved.

Copyright (c) 1982, 1986, 1988, 1990, 1993, 1994, 1995 The Regents of the University of California. All rights reserved.

Copyright (c) 1982, 1986, 1988, 1990, 1993, 1995 The Regents of the University of California. All rights reserved.

Copyright (c) 1982, 1986, 1988, 1991, 1993 The Regents of the University of California. All rights reserved.

Copyright (c) 1982, 1986, 1988, 1993 The Regents of the University of California. All rights reserved.

Copyright (c) 1982, 1986, 1988, 1993, 1995 The Regents of the University of California. All rights reserved.

Copyright (c) 1982, 1986, 1989, 1991, 1993 The Regents of the University of California. All rights reserved.

Copyright (c) 1982, 1986, 1989, 1993 The Regents of the University of California. All rights reserved.

Copyright (c) 1982, 1986, 1990, 1991, 1993 The Regents of the University of California. All rights reserved.

Copyright (c) 1982, 1986, 1990, 1993 The Regents of the University of California. All rights reserved.

Copyright (c) 1982, 1986, 1990, 1993, 1994 The Regents of the University of California. All rights reserved.

Copyright (c) 1982, 1986, 1991, 1993 The Regents of the University of California. All rights reserved.

Copyright (c) 1982, 1986, 1991, 1993, 1994 The Regents of the University of California. All rights reserved.

Copyright (c) 1982, 1986, 1991, 1993, 1995 The Regents of the University of California. All rights reserved.

Copyright (c) 1982, 1986, 1993 The Regents of the University of California. All rights reserved.

Copyright (c) 1982, 1986, 1993, 1994 The Regents of the University of California. All rights reserved.

Copyright (c) 1982, 1986, 1993, 1994, 1995 The Regents of the University of

California. All rights reserved.

Copyright (c) 1982, 1986, 1993, 1995 The Regents of the University of California.

All rights reserved.

Copyright (c) 1982, 1988, 1991, 1993 The Regents of the University of California.

All rights reserved.

Copyright (c) 1983, 1990, 1993 The Regents of the University of California. All rights reserved.

Copyright (c) 1983, 1993 The Regents of the University of California. All rights reserved.

Copyright (c) 1985, 1986, 1993 The Regents of the University of California. All rights reserved.

Copyright (c) 1985, 1986, 1993 The Regents of the University of California. All rights reserved.

Copyright (c) 1986, 1989, 1991, 1993 The Regents of the University of California.

All rights reserved.

Copyright (c) 1986, 1993 The Regents of the University of California. All rights reserved.

Copyright (c) 1987, 1991, 1993 The Regents of the University of California. All rights reserved.

Copyright (c) 1987, 1993 The Regents of the University of California. All rights reserved.

Copyright (c) 1987, 1993 The Regents of the University of California. All rights reserved.

Copyright (c) 1988 Regents of the University of California. All rights reserved

Copyright (c) 1988 Stephen Deering.

Copyright (c) 1988 University of Utah.

Copyright (c) 1988, 1989, 1993 The Regents of the University of California. All rights reserved.

Copyright (c) 1988, 1991, 1993 The Regents of the University of California. All rights reserved.

Copyright (c) 1988, 1992, 1993 The Regents of the University of California. All rights reserved.

Copyright (c) 1988, 1993 The Regents of the University of California. All rights reserved.

Copyright (c) 1989 The Regents of the University of California. All rights reserved.

Copyright (c) 1989, 1991, 1993 The Regents of the University of California. All rights reserved.

Copyright (c) 1989, 1993 The Regents of the University of California. All rights reserved.

Copyright (c) 1989, 1993, 1994 The Regents of the University of California. All rights reserved.

Copyright (c) 1990, 1991, 1993 The Regents of the University of California. All rights reserved.

Copyright (c) 1990, 1993 The Regents of the University of California. All rights reserved.

Copyright (c) 1991, 1993 The Regents of the University of California. All rights reserved.

Copyright (c) 1991, 1993, 1994 The Regents of the University of California. All rights reserved.

Copyright (c) 1992 Regents of the University of California. All rights reserved.

Copyright (c) 1992, 1993 The Regents of the University of California. All rights reserved.

reserved.

Copyright (c) 1993 The Regents of the University of California. All rights reserved.

Copyright (c) 1993 Adam Glass

Copyright (C) 1993 by Sun Microsystems, Inc. All rights reserved.

Copyright (c) 1994 Gordon W. Ross

Copyright (c) 1994 Winning Strategies, Inc. All rights reserved.

Copyright (c) 1995 The Regents of the University of California. All rights reserved.

Copyright (C) 1995, 1996, 1997, and 1998 WIDE Project. All rights reserved.

Copyright (c) 1996 The Regents of the University of California. All rights reserved.

Copyright (c) 1996 John S. Dyson All rights reserved.

Copyright (c) 1996 Matt Thomas. All rights reserved.

Copyright (c) 1996 Matthew R. Green. All rights reserved.

Copyright (c) 1996 Paul Kranenburg

Copyright (c) 1996, 1997, 1999, 2001 The NetBSD Foundation, Inc. All rights

reserved.

Copyright (c) 1996, 2000 Christopher G. Demetriou. All rights reserved.

Copyright (c) 1996,1999 by Internet Software Consortium.

Copyright (c) 1996-1999 by Internet Software Consortium.

Copyright (c) 1997 Jonathan Stone and Jason R. Thorpe. All rights reserved.

Copyright (c) 1997 Christos Zoulas. All rights reserved.

Copyright (c) 1997 Manuel Bouyer. All rights reserved.

Copyright (c) 1997, 1998 The NetBSD Foundation, Inc. All rights reserved.

Copyright (c) 1997, 1998, 1999, 2000 The NetBSD Foundation, Inc. All rights

reserved.

Copyright (c) 1997, 1998, 1999, 2001 The NetBSD Foundation, Inc. All rights

reserved.

Copyright (c) 1997, 1998, 1999, 2002 The NetBSD Foundation, Inc. All rights

reserved.

Copyright (c) 1997, 1998, 2000, 2001 The NetBSD Foundation, Inc. All rights

reserved.

Copyright (c) 1997, 1998, 2001 The NetBSD Foundation, Inc. All rights reserved.

Copyright (c) 1997,98 The NetBSD Foundation, Inc. All rights reserved.

Copyright (C) 1997-2000 Sony Computer Science Laboratories Inc. All rights

reserved.

Copyright (c) 1997-2002 The NetBSD Foundation, Inc. All rights reserved.

Copyright (c) 1998 The NetBSD Foundation, Inc. All rights reserved.

Copyright (c) 1998 Todd C. Miller <Todd.Miller@courtesan.com> All rights

reserved.

Copyright (c) 1998, 1999 The NetBSD Foundation, Inc. All rights reserved.

Copyright (c) 1998, 1999, 2000 The NetBSD Foundation, Inc. All rights reserved.

Copyright (c) 1998, 1999, 2000, 2001 The NetBSD Foundation, Inc. All rights

reserved.

Copyright (c) 1998, 2000 The NetBSD Foundation, Inc. All rights reserved.

Copyright (c) 1998, 2000, 2001 The NetBSD Foundation, Inc. All rights reserved.

Copyright (c) 1999 The NetBSD Foundation, Inc. All rights reserved.

Copyright (C) 1999 WIDE Project. All rights reserved.

Copyright (c) 1999, 2000 Jason L. Wright (jason@thought.net) All rights reserved.

Copyright (c) 1999, 2000 The NetBSD Foundation, Inc. All rights reserved.

Copyright (c) 1999, 2000, 2001 The NetBSD Foundation, Inc. All rights reserved.

Copyright (c) 1999, 2001 The NetBSD Foundation, Inc. All rights reserved.

Copyright (c) 2000 The NetBSD Foundation, Inc. All rights reserved.

Copyright (c) 2000, 2001 The NetBSD Foundation, Inc. All rights reserved.
Copyright (c) 2000, 2001, 2002 The NetBSD Foundation, Inc. All rights reserved.
Copyright (c) 2001 The NetBSD Foundation, Inc. All rights reserved.
Copyright (c) 2002 The NetBSD Foundation, Inc. All rights reserved.
Copyright 1998 Massachusetts Institute of Technology. All rights reserved.
Copyright 2001 Wasabi Systems, Inc. All rights reserved. Portions
Copyright (c) 1993 by Digital Equipment Corporation. Portions
Copyright (c) 1995 by International Business Machines, Inc.
Copyright (c) 1983, 1989 The Regents of the University of California. All rights reserved.
Copyright (c) 1996 by Internet Software Consortium. All rights reserved.
Copyright (c) 1980, 1986, 1989 Regents of the University of California. All rights reserved.
Copyright (c) 1988 The Regents of the University of California. All rights reserved.
Copyright (c) 1992, 1993 The Regents of the University of California. All rights reserved.
Copyright (c) 1994 Christopher G. Demetriou. All rights reserved.
Copyright (c) 1997 The NetBSD Foundation, Inc. All rights reserved.
Copyright (c) 1999 The NetBSD Foundation, Inc. All rights reserved.
Copyright (c) 2001 The NetBSD Foundation, Inc. All rights reserved.
Copyright (c) 1996 Gardner Buchanan <gbuchanan@shl.com> All rights reserved.

Parts of the NetBSD Kernel are provided with the licenses that are slightly different from the above Berkeley-formed license. Please refer the source code of the NetBSD Kernel about the details.

The source code of the NetBSD Kernel is provided by the NetBSD CVS Repositories (<http://cvsweb.netbsd.org/bsdweb.cgi/>), and this product includes parts of the source code in the following directories.

<http://cvsweb.netbsd.org/bsdweb.cgi/src/sys/kern/>
<http://cvsweb.netbsd.org/bsdweb.cgi/src/sys/net/>
<http://cvsweb.netbsd.org/bsdweb.cgi/src/sys/netinet/>

<<OpenSSL>>

The product includes software developed by the OpenSSL Project and it is used under the following license.

LICENSE ISSUES

=====

The OpenSSL toolkit stays under a dual license, i.e. both the conditions of the OpenSSL License and the original SSLeay license apply to the toolkit. See below for the actual license texts. Actually both licenses are BSD-style Open Source licenses. In case of any license issues related to OpenSSL please contact openssl-core@openssl.org.

OpenSSL License

```

/* =====
=====
* Copyright (c) 1998-2006 The OpenSSL Project. All rights reserved.
*
* Redistribution and use in source and binary forms, with or without
* modification, are permitted provided that the following conditions
* are met:
*
* 1. Redistributions of source code must retain the above copyright
* notice, this list of conditions and the following disclaimer.
*
* 2. Redistributions in binary form must reproduce the above copyright
* notice, this list of conditions and the following disclaimer in
* the documentation and/or other materials provided with the
* distribution.
*
* 3. All advertising materials mentioning features or use of this
* software must display the following acknowledgment:
* "This product includes software developed by the OpenSSL Project
* for use in the OpenSSL Toolkit. (http://www.openssl.org/)"
*
* 4. The names "OpenSSL Toolkit" and "OpenSSL Project" must not be used to
* endorse or promote products derived from this software without
* prior written permission. For written permission, please contact
* openssl-core@openssl.org.
*
* 5. Products derived from this software may not be called "OpenSSL"
* nor may "OpenSSL" appear in their names without prior written
* permission of the OpenSSL Project.
*
* 6. Redistributions of any form whatsoever must retain the following
* acknowledgment:
* "This product includes software developed by the OpenSSL Project
* for use in the OpenSSL Toolkit (http://www.openssl.org/)"
*
* THIS SOFTWARE IS PROVIDED BY THE OpenSSL PROJECT ``AS IS" AND
ANY
* EXPRESSED OR IMPLIED WARRANTIES, INCLUDING, BUT NOT LIMITED
TO, THE
* IMPLIED WARRANTIES OF MERCHANTABILITY AND FITNESS FOR A
PARTICULAR
* PURPOSE ARE DISCLAIMED. IN NO EVENT SHALL THE OpenSSL
PROJECT OR
* ITS CONTRIBUTORS BE LIABLE FOR ANY DIRECT, INDIRECT, INCIDENTAL,
* SPECIAL, EXEMPLARY, OR CONSEQUENTIAL DAMAGES (INCLUDING, BUT
* NOT LIMITED TO, PROCUREMENT OF SUBSTITUTE GOODS OR
SERVICES;
* LOSS OF USE, DATA, OR PROFITS; OR BUSINESS INTERRUPTION)
* HOWEVER CAUSED AND ON ANY THEORY OF LIABILITY, WHETHER IN
CONTRACT,
* STRICT LIABILITY, OR TORT (INCLUDING NEGLIGENCE OR OTHERWISE)

```

* ARISING IN ANY WAY OUT OF THE USE OF THIS SOFTWARE, EVEN IF ADVISED

* OF THE POSSIBILITY OF SUCH DAMAGE.

* =====

=====

*

* This product includes cryptographic software written by Eric Young (eay@cryptsoft.com). This product includes software written by Tim Hudson (tjh@cryptsoft.com).

*

*/

Original SSLeay License

/* Copyright (C) 1995-1998 Eric Young (eay@cryptsoft.com)

* All rights reserved.

*

* This package is an SSL implementation written

* by Eric Young (eay@cryptsoft.com).

* The implementation was written so as to conform with Netscapes SSL.

*

* This library is free for commercial and non-commercial use as long as

* the following conditions are aheared to. The following conditions

* apply to all code found in this distribution, be it the RC4, RSA,

* lhash, DES, etc., code; not just the SSL code. The SSL documentation

* included with this distribution is covered by the same copyright terms

* except that the holder is Tim Hudson (tjh@cryptsoft.com).

*

* Copyright remains Eric Young's, and as such any Copyright notices in

* the code are not to be removed.

* If this package is used in a product, Eric Young should be given attribution

* as the author of the parts of the library used.

* This can be in the form of a textual message at program startup or

* in documentation (online or textual) provided with the package.

*

* Redistribution and use in source and binary forms, with or without

* modification, are permitted provided that the following conditions

* are met:

* 1. Redistributions of source code must retain the copyright

* notice, this list of conditions and the following disclaimer.

* 2. Redistributions in binary form must reproduce the above copyright

* notice, this list of conditions and the following disclaimer in the

* documentation and/or other materials provided with the distribution.

* 3. All advertising materials mentioning features or use of this software

* must display the following acknowledgement:

* "This product includes cryptographic software written by

* Eric Young (eay@cryptsoft.com)"

* The word 'cryptographic' can be left out if the rouines from the library

* being used are not cryptographic related :-).

```

* 4. If you include any Windows specific code (or a derivative thereof) from
* the apps directory (application code) you must include an acknowledgement:
* "This product includes software written by Tim Hudson (tjh@cryptsoft.com)"
*
* THIS SOFTWARE IS PROVIDED BY ERIC YOUNG ``AS IS'' AND
* ANY EXPRESS OR IMPLIED WARRANTIES, INCLUDING, BUT NOT LIMITED TO, THE
* IMPLIED WARRANTIES OF MERCHANTABILITY AND FITNESS FOR A PARTICULAR PURPOSE
* ARE DISCLAIMED. IN NO EVENT SHALL THE AUTHOR OR CONTRIBUTORS BE LIABLE
* FOR ANY DIRECT, INDIRECT, INCIDENTAL, SPECIAL, EXEMPLARY, OR CONSEQUENTIAL
* DAMAGES (INCLUDING, BUT NOT LIMITED TO, PROCUREMENT OF SUBSTITUTE GOODS
* OR SERVICES; LOSS OF USE, DATA, OR PROFITS; OR BUSINESS INTERRUPTION)
* HOWEVER CAUSED AND ON ANY THEORY OF LIABILITY, WHETHER IN CONTRACT, STRICT
* LIABILITY, OR TORT (INCLUDING NEGLIGENCE OR OTHERWISE) ARISING IN ANY WAY
* OUT OF THE USE OF THIS SOFTWARE, EVEN IF ADVISED OF THE POSSIBILITY OF
* SUCH DAMAGE.
*
* The licence and distribution terms for any publically available version or
* derivative of this code cannot be changed. i.e. this code cannot simply be
* copied and put under another distribution licence
* [including the GNU Public Licence.]
*/

```

<<MD5>>

This software uses the Source Code of RSA Data Security, Inc. described in the RFC1321 (MD5 Message-Digest Algorithm).

 Copyright (C) 1991-2, RSA Data Security, Inc. Created 1991. All rights reserved.

License to copy and use this software is granted provided that it is identified as the "RSA Data Security, Inc. MD5 Message-Digest Algorithm" in all material mentioning or referencing this software or this function.

License is also granted to make and use derivative works provided that such works are identified as "derived from the RSA Data Security, Inc. MD5 Message-Digest Algorithm" in all material mentioning or referencing the derived work.

RSA Data Security, Inc. makes no representations concerning either the merchantability of this software or the suitability of this software for any particular purpose. It is provided "as is"

Useful Information

without express or implied warranty of any kind.

These notices must be retained in any copies of any part of this documentation and/or software.

<<MT19937>>

The MT19937 software that Takuji Nishimura and Makoto Matsumoto developed is contained, and this product shall be used subject to the following license conditions.

Copyright (C) 1997 - 2002, Makoto Matsumoto and Takuji Nishimura, All rights reserved.

Redistribution and use in source and binary forms, with or without modification, are permitted provided that the following conditions are met:

1. Redistributions of source code must retain the above copyright notice, this list of conditions and the following disclaimer.
2. Redistributions in binary form must reproduce the above copyright notice, this list of conditions and the following disclaimer in the documentation and/or other materials provided with the distribution.
3. The names of its contributors may not be used to endorse or promote products derived from this software without specific prior written permission.

THIS SOFTWARE IS PROVIDED BY THE COPYRIGHT HOLDERS AND CONTRIBUTORS

"AS IS" AND ANY EXPRESS OR IMPLIED WARRANTIES, INCLUDING, BUT NOT

LIMITED TO, THE IMPLIED WARRANTIES OF MERCHANTABILITY AND FITNESS FOR

A PARTICULAR PURPOSE ARE DISCLAIMED. IN NO EVENT SHALL THE COPYRIGHT OWNER OR

CONTRIBUTORS BE LIABLE FOR ANY DIRECT, INDIRECT, INCIDENTAL, SPECIAL,

EXEMPLARY, OR CONSEQUENTIAL DAMAGES (INCLUDING, BUT NOT LIMITED TO,

PROCUREMENT OF SUBSTITUTE GOODS OR SERVICES; LOSS OF USE, DATA, OR

PROFITS; OR BUSINESS INTERRUPTION) HOWEVER CAUSED AND ON ANY THEORY OF

LIABILITY, WHETHER IN CONTRACT, STRICT LIABILITY, OR TORT (INCLUDING

NEGLIGENCE OR OTHERWISE) ARISING IN ANY WAY OUT OF THE USE OF THIS

SOFTWARE, EVEN IF ADVISED OF THE POSSIBILITY OF SUCH DAMAGE.

<<thttpd>>

The thttpd software that ACME Labs developed is contained, and this product

Specifications

■ Standard:

DECT (Digital Enhanced Cordless Telecommunications),
GAP (Generic Access Profile)

■ Number of channels:

120 Duplex Channels

■ Frequency range:

1.88 GHz to 1.9 GHz

■ Duplex procedure:

TDMA (Time Division Multiple Access)

■ Channel spacing:

1,728 kHz

■ Bit rate:

1,152 kbit/s

■ Modulation:

GFSK (Gaussian Frequency Shift Keying)

■ RF transmission power:

Approx. 250 mW

■ Power source:

220–240 V AC, 50 Hz

■ Network interface:

10/100base-TX auto MDI/MDIX
Ethernet LAN port

■ Support codecs:

G.711 μ -law, G.711 A-law, G.726 (32k),
G.729A

■ Power consumption:

Base unit:

BB-GT1500

Standby: Approx. 3.0 W

Maximum: Approx. 6.5 W

BB-GT1520/BB-GT1522

Standby: Approx. 3.0 W

Maximum: Approx. 6.5 W

BB-GT1540

Standby: Approx. 3.0 W

Maximum: Approx. 6.9 W

Charger:

Standby: Approx. 1.1 W

Maximum: Approx. 5.2 W

■ Operating conditions:

5 °C–40 °C, 20 %–80 % relative air
humidity (dry)

■ Dimensions:

Base unit: Approx. 82 mm × 189 mm ×
129 mm

Handset: Approx. 156 mm × 48 mm × 33
mm

Charger: Approx. 68 mm × 82 mm × 87
mm

■ Mass (weight):

Base unit:

BB-GT1500

Approx. 310 g

BB-GT1520/BB-GT1522

Approx. 360 g

BB-GT1540

Approx. 390 g

Handset: Approx. 160 g

Charger: Approx. 80 g

Note:

- Design and specifications are subject to change without notice.
- The illustrations in these instructions may vary slightly from the actual product.

Conditions of guarantee

This guarantee is in addition to and does not in any way affect any statutory or other rights of consumer purchasers. If within the applicable guarantee period, the appliance proves to be defective by reason of faulty design, workmanship or materials, we undertake subject to the following conditions to have the defective appliance (or any part or parts thereof) repaired or replaced free of charge.

1. The appliance shall have been purchased and used solely within either the UK or ROI and in accordance with standard operating instructions and the technical and/or Safety Standards required in the UK.
2. The appliance should be returned together with this guarantee and proof of date of purchase promptly on being found defective at the purchaser's risk and expense to the authorised dealer from whom the appliance was purchased or to the nearest authorised dealer. All enquires must be through such dealers.
3. This guarantee shall not apply to damage caused through fire, accident, lightning, misuse, wear and tear, neglect, incorrect adjustment or repair, to damage caused through installation, adaption, modification or use in an improper manner or inconsistent with the technical and/or safety standards required in the country where this appliance is used, or to damage occurred during transit to or from the purchaser.
4. If at any time during the guarantee period any part or parts of the appliance are replaced with a part or parts not supplied or approved by us or of an objective quality safe and suitable for the appliance, or the appliance has been dismantled or repaired by any person not authorised by us, we shall have the right to terminate this guarantee in whole or in part immediately without further notice.
5. The purchaser's sole and exclusive remedy under this guarantee against us is for the repair or replacement of the appliance or any defective part or parts and no other remedy, including, but not limited to, incidental or consequential damage or loss of whatsoever nature shall be available to the purchaser.
6. This guarantee shall not apply to batteries and any other items of limited natural life.
7. Our decision on all matters relating to complaints shall be final. Any appliance or defective part which has been replaced shall become our property.
8. The guarantee period applicable to this product shall be 12 months.

Please keep these operating instructions with your receipt.

Panasonic Business Systems U.K.

Receipt No. _____

Date of purchase _____

Model No. _____

Serial No. _____

Customer services

joip customer support

joip is the VoIP service provided by deltathree, Inc. for this phone. If you cannot make or receive internet calls or if you are experiencing any other issues with your VoIP telephone services, please contact joip customer support.

- Visit **www.joip.com** or send an email to **support@joip.com**
- Call ✖**JOIP (✖5647)** from your GLOBARANGE phone using the IP line.
- For customers within the UK, call **020 7100 7403** using the landline.
For customers within the Republic of Ireland, call **01529 0157** using the landline.

In case of replacing your GLOBARANGE phone, you will need to contact joip Support Centre in order to transfer your joip number and account information to the new phone.

You will not be able to use your joip account on the new phone unless you contact joip Support Centre. For more information, please go to the Support section of the Member Centre using your joip number and password at www.joip.com

If you are experiencing any difficulty with your phone's functions or features, please contact Panasonic.

Panasonic sales and support information

joip is the VoIP service provided by deltathree, Inc. for this phone. If you cannot make or receive internet calls or if you are experiencing any other issues with your VoIP telephone services, please contact joip customer support. If you are experiencing any difficulty with your phone's functions or features, please contact Panasonic as follows.

Customer Care Centre

- For customers within the UK: 0844 844 3898
- For customers within the Republic of Ireland: 01289 8333
- Visit our website for product information: **www.panasonic.co.uk**
- E-mail: **customer.care@panasonic.co.uk**

Direct Sales at Panasonic UK

- Order accessory and consumable items for your product with ease and confidence by phoning our Customer Care Centre Monday - Thursday 9:00am - 5:30pm, Friday 9:30am - 5:30pm (Excluding public holidays).
- Or go on line through our Internet Accessory ordering application at **www.panasonic.co.uk**
- Most major credit and debit cards accepted.

- All enquiries transactions and distribution facilities are provided directly by Panasonic UK Ltd.
- It couldn't be simpler!
- Also available through our Internet is direct shopping for a wide range of finished products, take a browse on our website for further details.

Customer Care Helpline Tel. No.: U.K. 0844 844 3898 / R.O.I. 01289 8333

Useful Information

We recommend keeping a record of the following information for future reference.

Date of purchase

Serial No.

(found on the bottom of the base unit)

MAC address

(found on the bottom of the base unit)

Name and address of dealer

joip number #

Password for the joip website (www.joip.com)*¹

*1 The password is received via a joip text message (page 74) after you agreed to the Terms of Use for the joip services (page 19).

Attach your purchase receipt here.

Note:

- This equipment is designed for use on the UK and Republic of Ireland analogue telephone network.
- In the event of problems related to:
 - functions or features, you should contact your equipment supplier in the first instance.
 - VoIP telephone service, you should contact joip customer support (page 104).

Declaration of Conformity:

- Panasonic Communications Co., Ltd. declares that this equipment is in compliance with the essential requirements and other relevant provisions of Radio & Telecommunications Terminal Equipment (R&TTE) Directive 1999/5/EC. Declarations of Conformity for the relevant Panasonic products described in this manual are available for download by visiting:
<http://www.doc.panasonic.de>

Contact:

Panasonic Services Europe
a Division of Panasonic Marketing Europe GmbH
Panasonic Testing Centre
Winsbergring 15, 22525 Hamburg, Germany

Index

- A** Alarm: 55
 Answering calls: 33, 36
 Answering system
 Erasing messages: 62, 63, 65
 Listening to messages: 61, 62, 64
 Turning on/off: 60, 63, 65
 Auto intercom: 69, 71
 Auto talk: 33
- B** Battery: 19, 22
 Belt clip: 7, 76
- C** Caller ID edit: 45
 Caller ID service: 44
 Caller list: 45, 46
 Calling code: 55
 Call privacy: 34
 Call screening: 60, 67
 Call share: 34, 38
 Call Waiting: 34, 37
 Call Waiting Caller ID: 44
 Cancelling: 77
 Chain dial: 41
 Character entry: 79
 CID (Caller ID): 44
 Conference calls: 35, 38, 69, 71
 Connections: 18
 Customer support: 52
- D** Date and time: 29
 Default gateway: 30
 Deregistration: 77
 DHCP: 30
 Dial lock: 57
 Direct commands: 51, 52, 53, 54
 Display
 Contrast: 51
 Language: 29
 DNS: 31
- E** Emergency calls: 5
 Emergency numbers: 40
 Error messages: 81
- G** Greeting message: 61
- H** Handset LCD backlight: 33
 Handset name: 56
- Headset, optional: 9
 Hold: 33, 37
- I** Intercom: 69, 70
 Internet calls: 32, 36, 39
 Internet connection settings: 30
 Interrupt tone: 51
 IP address: 30
 IP indicator: 23
- J** joip: 4
 joip MSG alert: 75
 joip number: 4, 31
 joip service menu: 75
 joip Terms of Use: 19
 joip text message: 74
 Joystick: 17
- K** Keytones: 52
- L** Landline calls: 32, 36
 Light-up ID: 45
 Line selection: 29
- M** Making calls: 32, 36, 39
 MEMO: 63
 Memory capacity (message recording): 60
 Message alert: 66, 68, 74
 Missed calls: 44
 Mobile phone: 39
 Mute: 34, 37, 70, 71
 My joip numbers: 31
- N** Network settings: 30
 Night mode: 52, 58
 Number of rings: 66
- P** Page: 14, 71
 Pause: 33, 43
 Phonebook: 40
 Phonebook copy: 42
 Phonebook import: 73
 PIN
 Base unit: 51, 56
 Power failure: 20
- R** Recall: 34, 37
 Recall time: 57
 Recording time: 66
 Redial list: 32
 Registration: 77
 Remote code: 64

Remote operation: 64
Reset button: 78
Ring colour: 52
Ringer ID: 45
Ringer off: 33, 52, 59
Ringtone: 54, 59
Ringtone import: 73
Room monitor: 69, 71

S Service menu: 75
Soft keys: 17
Software update: 57
Speakerphone: 32, 36
Speed dialler: 43
Status indicator: 23, 86
Subnet mask: 30
System requirements: 7

T TEL indicator: 23
Time adjustment: 53
Toll saver: 66
Transferring calls: 69, 71
Troubleshooting: 84

V Voice guidance: 64
Voice Mail: 68
Volume
 Base unit ringer: 59
 Base unit speaker: 36
 Handset receiver: 32
 Handset ringer: 52
 Handset speaker: 32

CE0470

1999/5/EC

Sales Department:

Panasonic Business Systems U.K.

Panasonic House, Willoughby Road, Bracknell, Berkshire, RG12 8FP

Panasonic Communications Co., Ltd.

1-62, 4-chome, Minoshima, Hakata-ku, Fukuoka 812-8531, Japan

Copyright:

This material is copyrighted by Panasonic Communications Co., Ltd., and may be reproduced for internal use only. All other reproduction, in whole or in part, is prohibited without the written consent of Panasonic Communications Co., Ltd.

© 2007 Panasonic Communications Co., Ltd. All Rights Reserved.



GT1500E

Free Manuals Download Website

<http://myh66.com>

<http://usermanuals.us>

<http://www.somanuals.com>

<http://www.4manuals.cc>

<http://www.manual-lib.com>

<http://www.404manual.com>

<http://www.luxmanual.com>

<http://aubethermostatmanual.com>

Golf course search by state

<http://golfingnear.com>

Email search by domain

<http://emailbydomain.com>

Auto manuals search

<http://auto.somanuals.com>

TV manuals search

<http://tv.somanuals.com>