

Panasonic®

Personal Computer

OPERATING INSTRUCTIONS

CF-55 Series

Contents

Getting Started

Read Me First	5
First-time Operation	6
CD-ROM Drive	9

Operation

Starting Up/Shutting Down	10
Conserving Power	13
Security Measures	14
Add-ons/Peripherals	18
Storage, Carrying and Maintenance	22

Troubleshooting

Computer Diagnosis	23
Dealing with Problems	24
Technical Information	27
Reinstalling Software	28

Appendix

LIMITED USE LICENSE AGREEMENT	30
Windows 95 Setup Procedure	33
Setup Utility	34

Names and Functions of Parts..... 36

Specifications

Index

Customer's Record

Model No. _____	Dealer's Name _____
Serial No. _____	_____
or	
Code No. _____	Dealer's Address _____
Date of Purchase _____	_____

Introduction

Thank you for purchasing the Panasonic CF-55 series computer. Please read the Operating Instructions thoroughly for proper operation of your new computer.

Illustrations in this Manual

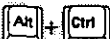
- NOTE** : **NOTE** provides a useful fact or helpful information.
- CAUTION** : **CAUTION** indicates a condition that may result in minor or moderate injury.
- WARNING** : **WARNING** indicates a hazard that may result in moderate or serious injury, or even death.
- [Start]-[Shut Down] : This illustration means to click [Start], and then to click [Shut Down].
(For some applications, you may need to double-click.)
-  : This illustration means to press the [Enter] key.
-  : This illustration means to press [Alt], and while holding down on [Alt], to press [Ctrl].

Copyright

This manual is copyrighted by Matsushita Electric Industrial Co., Ltd. with all rights reserved. No part of this manual may be reproduced in any form without the prior written permission of Matsushita Electric Industrial Co., Ltd. No patent liability is assumed with respect to the use of the information contained herein.

©Matsushita Electric Industrial Co., Ltd. 1997. All Rights Reserved.

Disclaimer

Computer specifications and manuals are subject to change without notice. Matsushita Electric Industrial Co., Ltd. assumes no liability for damage incurred directly or indirectly from errors, omissions or discrepancies between the computer and the manuals.

Trademarks

PS/2™ is a trademark of International Business Machines Corporation.

Microsoft®, MS-DOS® and Windows® are registered trademarks of Microsoft Corporation of the United States and/or other countries.

Pentium® is a registered trademark of Intel Corporation.

PhoenixCard Manager™ is a trademark of Phoenix Technologies Ltd.

Panasonic® is a registered trademark of Matsushita Electric Industrial Co., Ltd.

CD Drive Caution

CAUTION!

THIS PRODUCT UTILIZES A LASER.
USE OF CONTROLS, ADJUSTMENTS OR ADOPTION OF PROCEDURES OTHER THAN THOSE SPECIFIED HEREIN MAY RESULT IN HAZARDOUS RADIATION EXPOSURE. DO NOT OPEN COVERS AND DO NOT REPAIR YOURSELF.
REFER SERVICING TO QUALIFIED PERSONNEL

AVERTISSEMENT!

CET APPAREIL UTILISE UN LASER.
L'UTILISATION DE COMMANDES OU DE RÉGLAGES OU L'EXÉCUTION DE PROCÉDURES AUTRES QUE CELLES SPÉCIFIÉES ICI PEUVENT PROVOQUER UNE EXPOSITION À DES RADIATIONS DANGEREUSES.
NE PAS OUVRIR LES COUVERCLES NI ESSAYER DE RÉPARER SOI-MÊME.
CONFIER TOUT TRAVAIL D'ENTRETIEN À UN PERSONNEL QUALIFIÉ.

WARNING!

DIESES PRODUKT ERZEUGT LASERSTRAHLUNG.
DURCHFÜHRUNG ANDERER VORGÄNGE ALS DER HIER ANGEGEBENEN KANN ZU GEFÄHRLICHER STRAHLUNG FÜHREN.
REPARATUREN DÜRFEN NUR VON QUALIFIZIERTEM FACHPERSONAL DURCHGEFÜHRT WERDEN.

For U.S.A.

Federal Communications Commission Radio Frequency Interference Statement

Note: This equipment has been tested and found to comply with the limits for a Class B digital device, pursuant to Part 15 of the FCC Rules. These limits are designed to provide reasonable protection against harmful interference in a residential installation. This equipment generates, uses and can radiate radio frequency energy and, if not installed and used in accordance with the instructions may cause harmful interference to radio communications. However, there is no guarantee that interference will not occur in a particular installation. If this equipment does cause harmful interference to radio or television reception, which can be determined by turning the equipment off and on, the user is encouraged to try to correct the interference by one or more of the following measures:

- Reorient or relocate the receiving antenna.
- Increase the separation between the equipment and receiver.
- Connect the equipment into an outlet on a circuit different from that to which the receiver is connected.
- Consult the Panasonic Service Center or an experienced radio/TV technician for help.

Warning

To assure continued compliance, use only shielded interface cables when connecting to a computer or peripheral. Also, any changes or modifications not expressly approved by the party responsible for compliance could void the user's authority to operate this equipment.

This device complies with Part 15 of the FCC Rules. Operation is subject to the following two conditions:

- (1) This device may not cause harmful interference, and
- (2) This device must accept any interference received, including interference that may cause undesired operation.

For U.K.

Warning

This apparatus must be earthed for your safety.

To ensure safe operation the three-pin plug must be inserted only into a standard three-pin power point which is effectively earthed through the normal household wiring.

Extension cords used with the equipment must be three-core and be correctly wired to provide connection to earth. Wrongly wired extension cords are a major cause of fatalities.

The fact that the equipment operates satisfactorily does not imply that the power point is earthed and that the installation is completely safe.



For your safety, if you have any doubt about the effective earthing of the power point, consult a qualified electrician.

FOR YOUR SAFETY PLEASE READ THE FOLLOWING TEXT CAREFULLY

This appliance is supplied with a moulded three pin mains plug for your safety and convenience.

A 3 amp fuse is fitted in this plug.

Should the fuse need to be replaced please ensure that the replacement fuse has a rating of 3 amps and that it is approved by ASTA or BSI to BS 1362.

Check for the ASTA mark  or the BSI mark  on the body of the fuse.

If the plug contains a removable fuse cover you must ensure that it is refitted when the fuse is replaced.

If you lose the fuse cover the plug must not be used until a replacement cover is obtained.

A replacement fuse cover can be purchased from your local Panasonic Dealer.

IF THE FITTED MOULDED PLUG IS UNSUITABLE FOR THE SOCKET OUTLET IN YOUR HOME THEN THE FUSE SHOULD BE REMOVED AND THE PLUG CUT OFF AND DISPOSED OF SAFELY.

THERE IS A DANGER OF SEVERE ELECTRICAL SHOCK IF THE CUT OFF PLUG IS INSERTED INTO ANY 13 AMP SOCKET.

If a new plug is to be fitted please observe the wiring code as shown below.

If in any doubt please consult a qualified electrician.

Warning: THIS APPLIANCE MUST BE EARTHED.

Important

The wires in this mains lead are coloured in accordance with the following code:

Green-and-yellow:	Earth
Blue:	Neutral
Brown:	Live

As the colours of the wires in the mains lead of this apparatus may not correspond with the coloured markings identifying the terminals in your plug, proceed as follows:

The wire which is coloured GREEN-and-YELLOW must be connected to the terminal in the plug which is marked by the letter E or by the safety earth symbol  coloured GREEN or GREEN-and-YELLOW.

The wire which is coloured Blue must be connected to the terminal which is marked with the letter N or coloured BLACK. The wire which is coloured Brown must be connected to the terminal which is marked with the letter L or coloured RED.

The mains plug on this equipment must be used to disconnect the mains power.

Please ensure that a socket outlet is available near the equipment and shall be easily accessible.

How to replace the fuse

Open the fuse compartment with a screwdriver and replace the fuse.

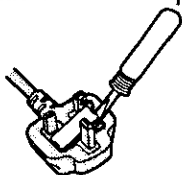

Warnings

- This equipment is not designed for connection to an IT power system.
(An IT system is a system having no direct connections between live parts and Earth; the exposed-conductive-parts of the electrical installation are earthed.
An IT system is not permitted where the computer is directly connected to public supply systems in the U.K.)
- Disconnect the mains plug from the supply socket when the computer is not in use.

This equipment is produced to BS800/1983.

Lithium Battery

Lithium Battery!

This computer contains a lithium battery to enable the date, time, and other data to be stored in it.

The battery should only be exchanged by service personnel. Warning! Risk of explosion from incorrect installation or mis-application!

Warnung bezüglich der Lithiumbatterie (Sicherungsbatterie)

Lithiumbatterie!

Dieser Computer enthält eine Lithiumbatterie zur Sicherung von Datum und Uhrzeit der eingebauten Uhr sowie anderer Systemdaten im Speicher bei einer Unterbrechung der Hauptstromversorgung. Diese Sicherungsbatterie darf nur von Kundendienstpersonal ausgewechselt werden.

Warnung! Bei falschem Gebrauch besteht Explosionsgefahr! Entsorgung gebrauchter Batterien nach Angaben des Herstellers.

Avertissement concernant la pile au lithium (pile de sauvegarde)

Pile au lithium!

Le micro-ordinateur renferme une pile au lithium qui permet de sauvegarder certaines données comme la date et l'heure notamment. Elle ne devra être remplacée que par un technicien qualifié.

Avertissement! Risque d'explosion en cas de non respect de cette mise en garde!

Precautions

● Usage

Avoid Extreme Heat and Cold

Do not store or use the computer in locations exposed to heat, direct sunlight, or extreme cold. Avoid moving the computer between locations with large temperature differences.

Operation: 5 °C to 35 °C (41 °F to 95 °F)

Storage: -20 °C to 60 °C (-4 °F to 140 °F)



Avoid Direct Sunlight on the LCD Panel

The LCD panel should not be exposed to direct sunlight or ultraviolet light.



Avoid Humidity Liquids and Dust

Do not store or use the computer in locations exposed to high humidity, liquids (including rain) or dust.



Prevent Shock

Avoid subjecting the computer to severe vibrations or impact. Do not place the computer inside a car trunk.

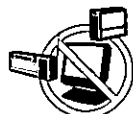

Avoid Radio Frequency Interference

Do not place the computer near a television or radio receiver.

● Handling



Avoid Magnetic Fields

Keep the computer away from magnets.



Avoid Stacking

Do not place heavy objects on top of the computer.



Keep Small Objects Away

Do not insert paper clips or other small objects into the computer.



Do Not Disassemble the Computer



Do not attempt to disassemble your computer.

● Cables

Use of an interface cable longer than 3 m (9.84 feet) is not recommended.

Read Me First

Saving Data on the Hard Disk

- **Do not expose your computer to shock.**
Shock may damage your hard disk or make your software applications and data unusable. Therefore, please use care when handling your computer.
- **Do not cut the power to your computer or adjust the angle of the display while the HDD indicator () is on or while software applications are running.**
Properly shut Windows* down to avoid problems ([Start]-[Shut Down]).
This computer houses the hard disk drive (HDD) in the back of the display, so if you adjust the angle of the display while the HDD indicator () is on, malfunction may result.
- **Save all valuable data to floppy disks.**
To limit damage should trouble occur to your computer or should you inadvertently change or erase data, it is a good idea to make backups on floppy disks.
- **Use the security function for all important data.**

 page 14 - Security Measures

* This computer uses Microsoft® Windows® 95 Operating System.

Saving Data on Floppy Disks

- **Do not cut the power to your computer or press the floppy disk drive (FDD) eject button while the FDD Indicator () is on.**
Doing so may damage the data on the floppy disk and make the disk useless.
- **Use care when handling floppy disks.**
To protect the data on your floppy disks or to prevent a floppy disk from becoming stuck in your computer, avoid the following:
 - Sliding the shutter on the floppy disk manually.
 - Exposing the disk to a magnetic field.
 - Storing the disk in locations prone to high temperatures, dampness, or dust.
 - Applying more than one label on the disk.
- **Confirm the contents of a floppy disk before formatting it.**
Confirm that no important data is on the disk, because all data on the disk will be erased.
- **Use the write-protect tab.**
This is a must for preserving important data. This prevents your data from being erased or overwritten.



Write Enable

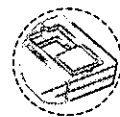

Write Disable

Computer Viruses

- **Users are advised to purchase the latest versions of virus protection software and use them regularly.**
We recommend you run the software:
 - When booting your computer.
 - After receiving data.We recommend that you check data received on floppy disks or from external sources, such as data downloaded from the Internet, e-mail, etc. (For compressed files, please uncompress them before running the software).

About Disk Utilities

- **Disk Utilities not conforming to FAT32 should not be used in the computer.**
Running such programs may result in the incorrect display of HDD content or damage to data on the HDD. For more information, please read the "Technical Information" ( page 27).

First-time Operation







It's now time to get started. Please read the steps below to help you learn what parts are included, and to gain an understanding of some basic computer-related operations.

1 Confirm the inclusion of all parts

Make sure the parts shown in the figure have been supplied. If any of them is missing or is not working properly, please consult your nearest Panasonic dealer.

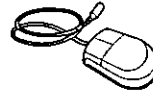
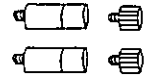
CAUTION

Please prepare one 2HD formatted floppy disk to create Firstaid FD of the Panasonic utilities. This Firstaid FD is to be used when reinstallation of the Panasonic utilities becomes necessary.

AC Adapter 1	AC Cord 1	Mouse 1	Screws 4
 CF-AA159			
Firstaid CD 1	Operating Instructions 1	Windows 95 System Pack 1	
			

2 Remove the rear panels to connect the AC adapter and other external devices

Remove the seal and then remove the back cover.

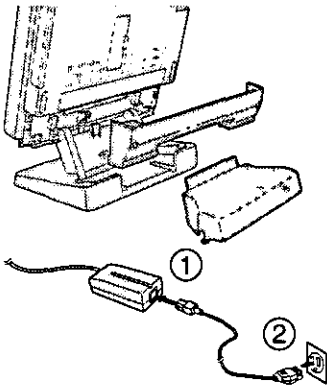

3 Connect the cables

Connect an AC adapter, a mouse, an optional keyboard and other optional devices (printer, serial devices etc.).

Adjust the angle of the display vertically, so that it is easy to see the connectors.
(☞ page 7)

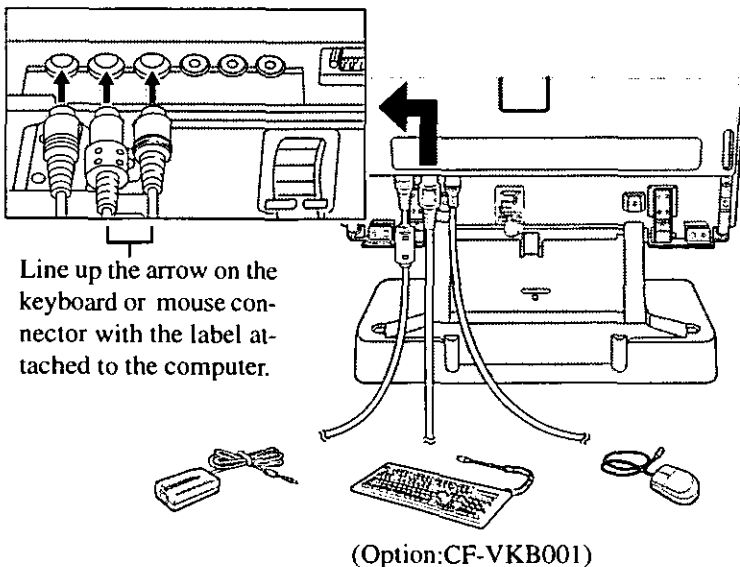

CAUTION

Be sure the AC adapter is connected until completing Step 9 on page 8.

Handling the AC adapter

- Do not twist or pull the AC power cord forcefully. Doing so may damage the connections.
- Use only the specified AC adapter (factory control number: CF-AA159) with your computer. Using an AC adapter other than the one supplied might damage the battery and/or the computer.
- When the DC plug is not connected to the computer, disconnect the AC cord from your AC wall outlet as well.
- Problems such as sudden voltage drops/surges may arise during periods of thunder and lightning. Since this could adversely affect your computer, an uninterruptible power source (UPS) is highly recommended.

4 Connect and store the cables

Bundle the cables with the clamp. You can store the AC adapter in the cover.

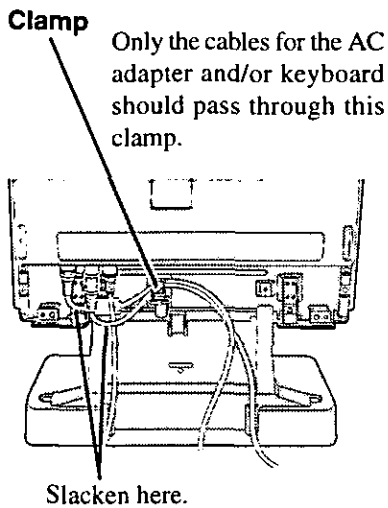

CAUTION

When you store the AC adapter in the cover, do not twist the cables forcefully.

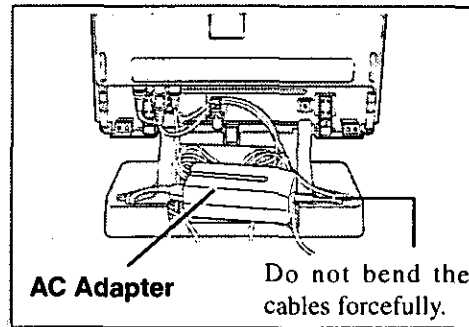

5 Attach the cover by tightening the four screws by hand

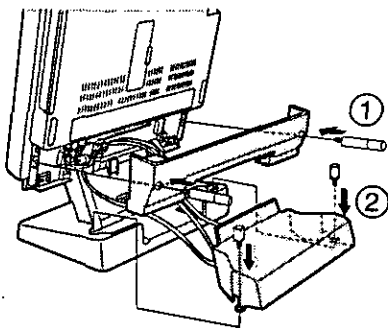

NOTE

The cables should partially extend behind the cover.

If an external display is connected, the cable will extend through the bottom of the cover.

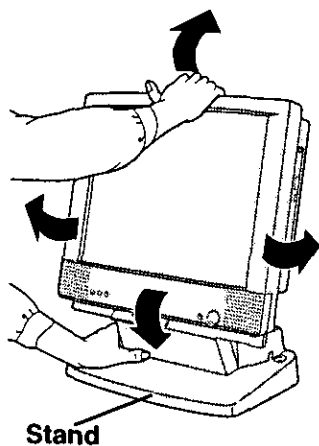
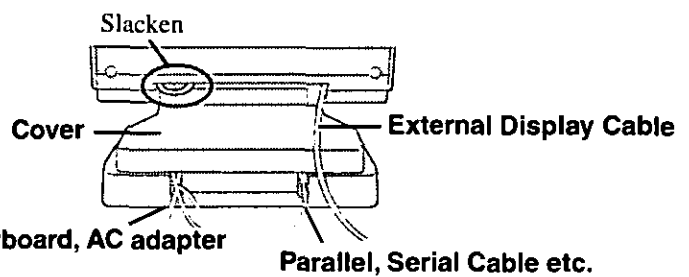

6 Adjust the angle of the display

Grasp the stand in hand and adjust by holding the upper part of the display.

CAUTION

- Place the computer on a flat and stable surface.
- Do not adjust the angle of the display while the HDD, FDD, CD-ROM indicators on.
- Do not place the computer near a television, radio receiver or magnet.
- Do not use the computer in a location where there is a lot of oily smoke or tobacco smoke. Doing so could shorten the service life of the CD-ROM drive.

First-time Operation

Press the power switch and hold until the power indicator goes on before releasing it.

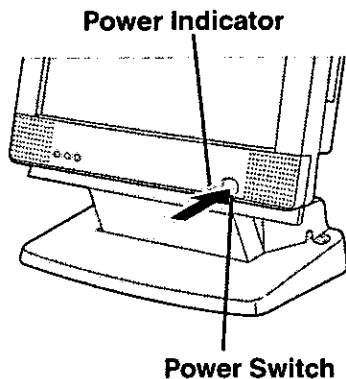

● Inserting a floppy disk

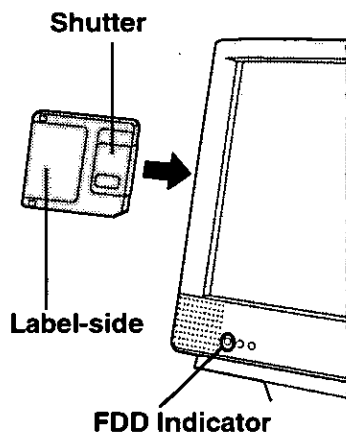

Label side toward you while inserting the shutter-side head first.

● Ejecting a floppy disk

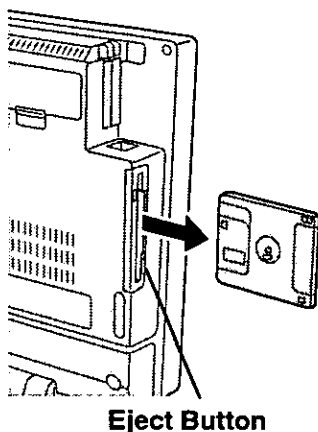

7 Read the LIMITED USE LICENCE AGREEMENT (page 30)

Before removing the seal covering the power switch, please read the LIMITED USE LICENCE AGREEMENT. Removal of this seal indicates agreement to the terms specified. After you have agreed to the terms, you may turn your computer on.

CAUTION

- Do not press the power switch repeatedly.
- After you have turned your computer off, you must wait more than ten seconds before you can turn it back on.
- Remove the lens protect sheet attached to the lens in the CD drive. (page 9)

8 Set Windows up

The [Windows 95 Setup] will run after the computer is turned on. Simply follow the instructions on the screen.

NOTE

- Please read the supplemental "Windows 95 Setup Procedure" for a more detailed explanation (page 33).
- If the display or the sound quality is not right, you can adjust the brightness, contrast and volume (page 36).

CAUTION

When removing a floppy disk, the floppy disk may spring out of the floppy disk drive. It may not a malfunction.

9 Close the Internet Explorer 4.0 window

At the [Welcome - Microsoft Internet Explorer], select at the upper right portion to close the screen.

10 Double-click (Panasonic Setup icon) on Windows

Be sure to have a blank floppy disk on hand then simply follow the instructions on the screen.

CAUTION

- It may take several minutes to reboot the computer.
- Please store the firstaid FD in a safe place. They will enable you to return your computer to factory default settings should any problems occur (page 27).
- Do not remove the floppy disk while the FDD indicator () is on, power down your computer or use the suspend function (page 11).

NOTE

About Internet Explorer 4.0

Please select the item that you want to open from the menu on the [Welcome - Microsoft Internet Explorer].

About the CF-55 series Readme

Please read the Readme file, as it contains important information. To access it, please click [Start] - [Programs] - [Panasonic] - [Read me please].

This concludes the first-time use operation guidelines.

CD-ROM Drive

Loading and Removing a CD

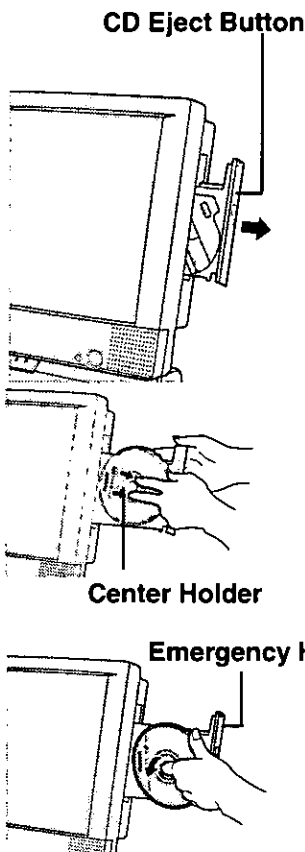

1 Turn your computer on

2 Press the CD eject button

The tray is partially extended automatically, slowly extend the remainder by hand.

NOTE

When you use the CD for the first time, remove the lens protect sheet attached to the lens in the CD-ROM drive.

While moving the computer, or if powered off for an extended period, attach this sheet to protect the lens.

3 ● Inserting a CD

Hold the CD so that your hand does not touch the data surface. With the label side facing up, set it into the center holder.

● Removing a CD

Place your finger on the center holder and lift up on the edge of the CD.

NOTE

To remove a CD when the computer is power off, insert a sharp object such as the bent-out tip of a paper clip into the emergency hole. Pushing it completely to the end will free the tray so that it can be pulled out.

4 Close the tray

Manually slide the tray closed.

CAUTION

- Do not leave the tray open or touch the lens.
- When the tray is open, applying too much force on the tray could damage it.
- Do not open the CD drive during CD access.
- Do not insert paper clips or other small objects into the CD drive.
- Be careful so that the computer does not fall when setting or removing a CD.
- Touching the data surface can make it dirty or even damage the CD. (For details on maintenance page 22) Particularly a video CD is influenced by dirt or damage, so it may not play or work properly. Be careful not to scratch a CD when handling.
- Do not use a CD that has become deformed (warped), not completely round, etc.
- The image can not be displayed smoothly when MPEG data or video CD is played by the software.
- The image may be disturbed when a photo CD is played. In a case like this, the image will be displayed properly when the photo CD is played again.
- If the CD is removed during CD playback, the computer may not work properly.

NOTE

In order to use the CD-ROM drive in the MS-DOS mode, follow the additional steps below to install the necessary driver.

- 1 Select [Start] - [Shut Down] - [Restart in MS-DOS], click
- 2 Type the following.
`cd \`
`edit config.sys`
- 3 Move the cursor to the line containing "ATAPICD.SYS" and delete the characters "REM" at the beginning of the line.
`device=c:\windows\command\atapicd.sys /d:miscd000`
- 4 Press Alt -F, then "S" to save the file. Then press Alt-F, then "X" to exit the Edit program.
- 5 Type the following.
`edit autoexec.bat`
- 6 Move the cursor to the line containing "MSCDEX.EXE" and delete the characters "REM" at the beginning of the line.
`c:\windows\command\mscdex.exe /d:miscd000 /L:L`
- 7 Press Alt -F, then "S" to save the file. Then press Alt-F, then "X" to exit the Edit program.
- 8 Restart the computer.

Starting Up/Shutting Down

Starting Up

1 Turn your computer on

CAUTION

- Do not press the power switch repeatedly.
- After you have turned your computer off, you must wait more than ten seconds before you can turn it back on.

- If [Enter Password:] or  is displayed, you must first enter your User Password (☞ page 14).

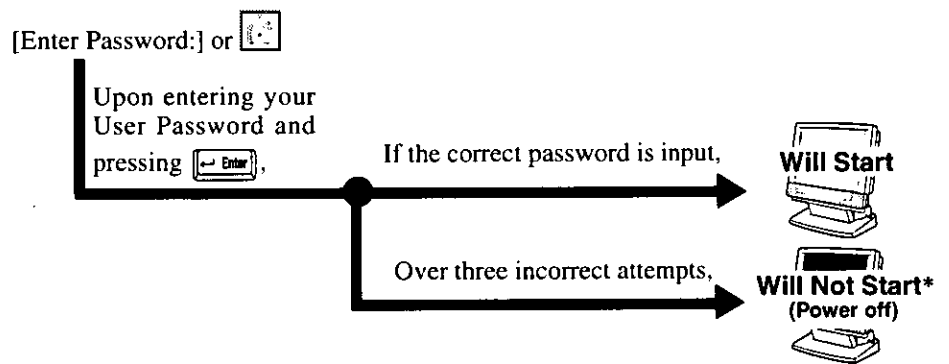

* If you are starting from the suspend mode (☞ page 11), if after three attempts the correct password is not input, or if no password is entered for about a minute, the computer returns to the suspend mode.

NOTE

If the display on the right appears, the network password has been set. To read and write data to other computers, the correct password must be entered.

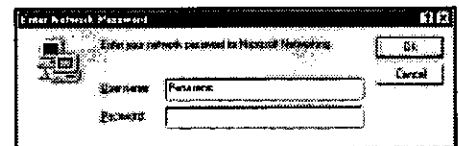

- When an application or file that was previously displayed appears on your screen, this means the suspend or hibernation mode (☞ page 11) has been set.

2 Select your application

You are able to start working on your computer.

NOTE

[System Devices] in [Device Manager] contains a device bearing an exclamation mark. This does not indicate a malfunction.

Using the Mouse

- Clicking
- Double-clicking
- Dragging

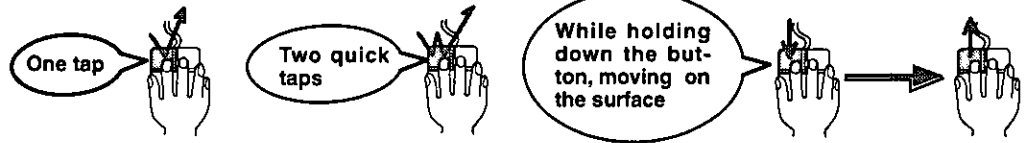

Shutting Down (power off your computer)

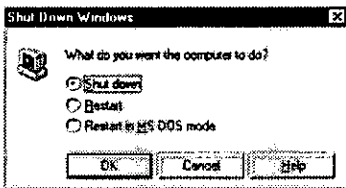

- 1 To shut down, save all data and select [Shut Down] from the [Start] menu

NOTE

From the keyboard,

you may choose to press down on or + and then select [Shut Down].

- 2 Confirm shutdown

Select [Shut down], then press . Your computer will power off automatically.

- Restarting your computer (without shutting down)

Select after selecting [Restart].

NOTE

To quickly resume computer operation after shutting down, the suspend and hibernation functions are available (below).

- Restarting your computer in MS-DOS mode

Select after selecting [Restart in MS-DOS].

NOTE

When returning to Windows 95 from the MS-DOS mode, type "EXIT" and not "WIN". Returning to Windows 95 using the "WIN" command may result in a malfunction.

Starting Up Your Computer Quickly

If you want to immediately start up and continue an application after shutting down your computer, you can do so by using the suspend or hibernation function.

- Differences between suspend function and hibernation function

Function	Where data is saved to	Speed	Requires power supply
Suspend function	Memory	Fast	Yes (if power is cut, all data is lost)
Hibernation function	Hard disk	Somewhat slow	Power is not required to maintain data

Problems such as sudden voltage drops/surges may arise during periods of lightning. It is recommended to use the hibernation function when such incident is likely to occur. Since this could adversely affect your computer, an uninterruptible power supply is highly recommended.

Starting Up/Shutting Down

Shutting Down

[Start] - [Suspend]



Power Switch

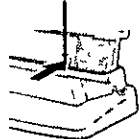

Do not touch the power switch while your computer is entering the hibernation mode

Hibernation Mode



● Using the suspend function

Select [Start] - [Suspend]

● Using the hibernation function

It is necessary to set the hibernation function using the Setup Utility

- 1 Run the Setup Utility (page 34)
- 2 Using and , select [Power Management] then press
- 3 Using and , select [Power Switch], set [Hibernation] with , then press
- 4 Close the Setup Utility (page 34)

CAUTION

- Save all data before powering off your computer
- When restarting from or shutting down to the suspend or hibernation mode, do not touch the mouse (serial or PS/2 type). There are cases where the mouse will fail to operate, you will have to restart your computer using the keyboard (page 11)
- Do not power off during the following periods (you may corrupt your data or file)
 - While the FDD indicator () , HDD indicator () or CD-ROM indicator () is on
 - While playing/recording audio files.
 - While communications software is being used
- Do not use the suspend or hibernation function when using an OS other than Windows 95, the diagnostics program (DIAG55), or the Setup Utility, or when experiencing static electricity or noise
- If you hold down on the , or key while pressing the power switch to enter the suspend or hibernation mode, after resuming operation, you must press the same key. For example, if you hold down on the key while pressing the power switch, upon resuming, if you do not press the key again, only capital letters will result from typing
- If your computer locks up, press the reset button. All data is lost when this button is pressed
- When a file in an external device such as an external hard disk or ATA card is opened, the suspend or hibernation function may not work. In such cases, close the file
- SCSI cards may not recover properly after entering the suspend or hibernation mode. If this occurs, restart the computer

Resuming Operation

If [Enter Password] or is displayed upon pressing the power switch, your password has been set (page 10)

Power Switch

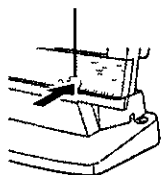

CAUTION

- Do not install or remove peripherals while your computer is in the suspend or hibernation mode, abnormal operation may result
- When operation resumes, serial devices such as a mouse or modem, or your PC Cards may not work. In such cases, you will need to restart your computer or reinitialize the individual devices















Conserving Power

Things to Remember

- **Leave your computer off when it is not in use** (☞ page 11)
- **In the power management mode, the setting of [Advanced] is recommended** (☞ below)
With the Setup Utility, you can set the [Advanced] mode.
- **Setting the suspend/hibernation timeout** (☞ below)
The suspend or hibernation function (☞ page 11) allows you to save power by automatically cutting off power when the computer is idle or there is no access to individual devices for 4 or 16 minutes.

Setting Power Management

(How to set [Advanced] and the suspend/hibernation timeout)

- 1 Run the Setup Utility** (☞ page 34)
- 2** Using  and , select [Power Management] then press 
- 3** Using  and , select [Power Saving] and set [Advanced] with 
(To avoid setting the hibernation timeout, press  and proceed on to step 6.)
- 4** Using  and , select [Power Switch] and set [Suspend] or [Hibernation] with 
- 5** Using  and , select [Suspend/Hibernation Timeout], set either [4 min] or [16 min] with , then press 
- 6** Close the Setup Utility (☞ page 34)

● Power Management settings

Power Management	Functions automatically set	CPU Speed Change Mode	HDD Motor Timeout	Display Off Timer
Advanced		Enable	5 min	5 min
Standard		Disable	Never	10 min
OFF		Disable	Never	Never

- **CPU Speed Change Mode** : When there are no operations, the CPU is automatically stopped.
- **HDD Motor Timeout** : When the hard disk drive is not accessed for more than five minutes, power to the HDD motor is cut off.
- **Display Off Timer** : When the computer is idle or a device is not accessed for five or ten minutes, power to the display is cut off.

CAUTION

When you need a network environment.

Be sure to disable the hibernation timeout settings with the Setup Utility .

After resuming operation from the hibernation mode, the network connection may be severed or the computer will not work properly.

In communications when a device like a high-speed modem or ISDN terminal adapter is connected to the serial port, etc.

There are times when high-speed communication is adversely affected if the power management function is enabled.

Key operation and music playback

When the power saving function is running, the keyboard and mouse operations may feel sluggish. Also, music may not be play correctly when entering the standby mode during operation.

Security Measures

To prevent illegal data access or theft, or theft of your computer, various security measures are provided below.

Situation	Function to use	Reference
You do not want your computer to be used without permission	User Password	☞ below
Same as above, but while you're away temporarily	Coffee break Password	☞ page 15
You want to prevent theft or damage to data by using a floppy disk	Prevent operation by floppy disk	☞ page 16
You do not want your Supervisor Setup changed without permission	Supervisor Password	☞ page 16
You want to prevent theft of your computer	Use a security lock	☞ page 37

When you do not want your computer to be used without permission

Set the User Password.

Without the password, access to your computer is impossible.





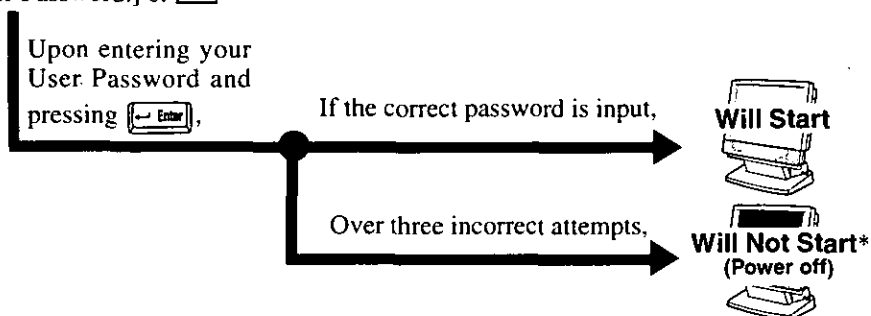

● When the User Password is set

[Enter Password:] or 







* If you are starting from the suspend mode (☞ page 11), if after three attempts the correct password is not input, or if no password is entered for about a minute, the computer returns to the suspend mode.

Setting the user password (enabling, changing, disabling)

- 1 Run the Setup Utility (☞ page 34)
- 2 Using  and , select [System Setup] then press .
- 3 Using  and , select [User Password] then press .
- 4 ● To enable or change your password

Enter your password at the [Enter User Password], then press .

CAUTION

- Your password will not be displayed on the screen.
- Please limit your password to seven characters. Note that there is no distinction between upper and lower case letters.
- Only the alphabet keys and numeric keys can be used. (Note: the special keys (,  etc.) cannot be used).
- Do not input your password while holding down on the  or .
- Use only the upper horizontal row of numeric keys to input user passwords. Keys on the right side of the enhanced keyboard can not be used.
- Do not forget your password. If a password is forgotten you will be unable to use your computer.

● To disable your password

Using the  and  keys, select [Delete User Password] then press . Go to step 7.

- 5** Re-enter your password at the [Enter User Password Again] (This is for confirmation purposes.)
- 6** Using and , select [Set User Password] then press .
- 7** At the confirmation screen, press .
- 8** Press to end the password setting procedure
- 9** Close the Setup Utility (☞ page 34)

CAUTION

To prevent the changing of your password without permission

- When running the Setup Utility program, do not leave your computer even for a short time.
- Set the User Password Protection option (☞ page 17).

You do not want your computer to be used without permission while away temporarily

You should set the “Coffee break Password” (Note that you must first set the User Password). When you input your selected key combination, the computer locks (key input and use of a mouse are no longer possible).

● When the coffee break password is set

When leaving your desk,

+ + (Example of a selected key combination.)

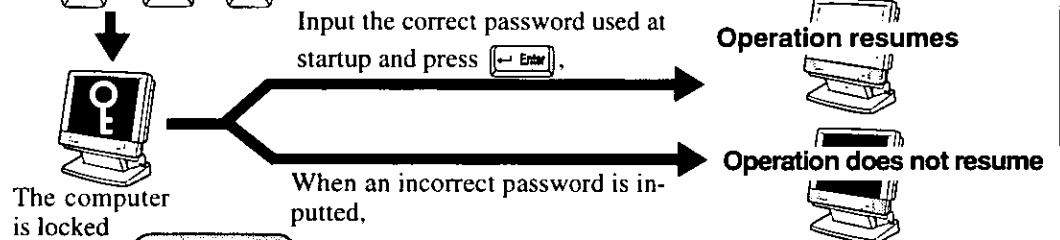

CAUTION

- Do not leave your computer just after sensitive data had been shown on the screen.
- It is impossible to lock your computer from an external device, such as a mouse connected through the serial port.
- During the coffee break, is displayed on the screen. If the operations described below are performed during the coffee break, the indication may disappear. In order to quit the coffee break and begin using the computer, input your password.
 - If the computer is returned from the standby mode.
 - If the serial mouse is moved.

Setting the Coffee break Password (enabling or disabling)

- 1** Set the User Password (☞ page 14 step 1 to 7), if it hasn't already
- 2** ● To enable the Coffee break Password
Using and , select [Coffee break Password] and set [Enable] with .
- To disable the Coffee break Password
Using and , select [Coffee break Password] and set [Disable] with .
- Go to step 4.
- 3** Using and keys, select [Key Combination for Coffee break] then set your combination of keys with .
- 4** Press to end the password setting procedure
- 5** Close the Setup Utility (☞ page 34)

Security Measures

When you want to prevent theft of or damage to data by using a floppy disk

You may choose to protect the data on your computer from being accessed illegally or overwritten accidentally by a floppy disk. You can also set your computer to be unbootable from a floppy disk.

● Preventing the use of a floppy disk

Even when one tries to access a floppy disk,



This error message is displayed.

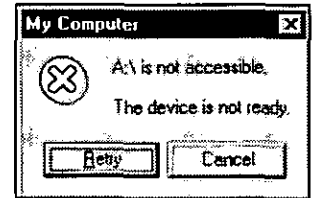

Procedure

- 1 Run the Setup Utility (page 34)
- 2 Using and , select [Supervisor Setup] then press
- 3 Using and , select [Boot Up Drive] then set [Hard Disk Drive] with

CAUTION

When changing to [Hard Disk Drive] setting, to continue read/write operation from a floppy disk and to use the HDD to start, press and go to step 5.

- 4 Using the and , select [Floppy Operation], set [Disable] with , then press
- 5 Close the Setup Utility (page 34)

When you do not want your Supervisor Setup changed without permission

Set the Supervisor Password. After it has been set, no changes can be made to the Supervisor settings unless the password is entered.

● When the supervisor password is set

In the Setup Utility, if [Enter Password:] or is displayed,

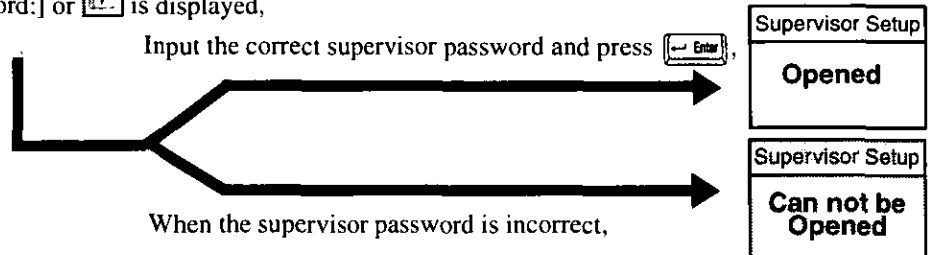







NOTE





You may wish to protect the User Password (page 17).

Setting the Supervisor Password



(enabling, changing, disabling)

- 1 Run the Setup Utility (☞ page 34)
- 2 Using  and , select [Supervisor Setup] then press .
- 3 Using  and , select [Supervisor Password] then press .
- 4 ● To enable or change your supervisor password
Enter your password at the [Enter Supervisor Password], then press .

CAUTION

- Your password will not be displayed on the screen.
- Please limit your password to seven characters. Note that there is no distinction between upper and lower case letters.
- Only the alphabet keys and numeric keys can be used. (Note: the special keys (,  etc.) cannot be used).
- Do not input your password while holding down on the  or .
- Use only the upper horizontal row of numeric keys to input user passwords. Keys on the right side of the enhanced keyboard can not be used.
- Do not forget your password. If a password is forgotten you will be unable to use your computer.

● To disable your supervisor password



Using  and , select [Delete Supervisor Password] then press . Go to step 7.





5 Re-enter your password at the [Enter Supervisor Password Again]

(This is for confirmation purposes.)

NOTE

When you do not want the user password enabled, changed, or disabled without permission,

use  and  to select [User Password Protection], and set [Enable] with .

- 6 Using  and , select [Set Supervisor Password] then press .
- 7 At the confirmation screen, press .
- 8 Press  to end the password setting procedure
- 9 Close the Setup Utility (☞ page 34)

Add-ons/Peripherals

Devices capable of being used by your computer are listed in the table below.

Device(s)	Where to connect	Reference
PC cards (Modem, LAN, SCSI etc.)	PC Card Slots	☞ below
Serial Devices (Mouse, Modem etc.)	Serial Port	☞ page 37
Extra Memory	RAM Module Slot	☞ page 20
External Display	Ext. Display Port	☞ page 21
Printer	Parallel Port	☞ page 21
Speaker/Headphone	Headphone Jack	☞ page 37
Audio device	Audio-in Jack	☞ page 37
Microphone	Microphone Jack	☞ page 37

Using PC Cards

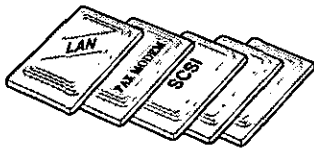

This computer has two PC Card slots. These slots conform to the PC Card Standard, and therefore, communications and SCSI devices can be utilized. The slot allows you to use two Type I or Type II cards (or one Type I and one Type II), or one Type III card.

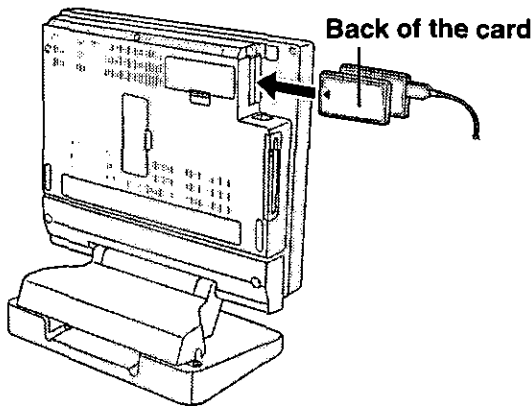

● Type I or II

Two cards can be used simultaneously.

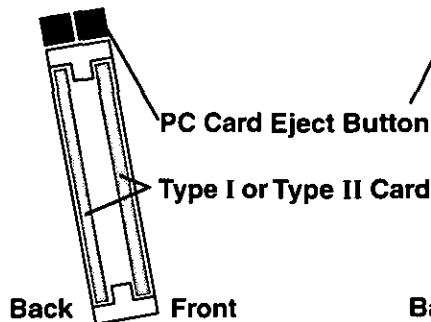

● Type III

One card can be used only in the back slot.

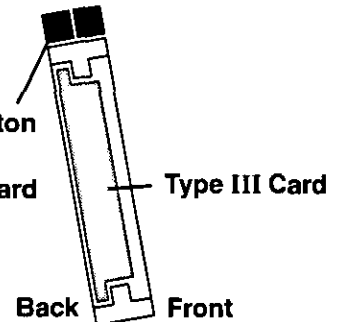

CAUTION

- Please check the PC cards' specifications. Be sure the total operating current does not exceed the specified limit, damage may result.
Allowable current (total for two slots) : 3.3 V: 400 mA, 5 V: 400 mA, 12 V: 120 mA
- There are times when both a Type I card and a Type II card will not work simultaneously.
- Some PC cards, example shown below, can not be used. The PC card's cable connector determines its physical compatibility.

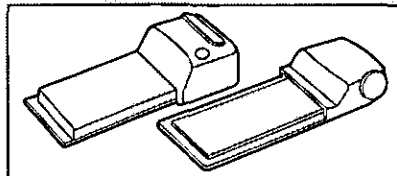

- SRAM and FLASH ROM cards (except for ATA interface) are not supported.
- When using a CardBus type card, use only that card; do not insert any other PC Cards.
- **Only the back slot can support a Zoomed Video (ZV) card. When you use a Zoomed Video card, the driver software is needed.**

Installing/Removing the PC Card

- 1 Power off your computer** (☞ page 11)
Do not shut down using the suspend or hibernation mode.

CAUTION

- Do not install or remove peripherals while your computer is in the suspend or hibernation mode; abnormal operation may result.
- Before removing a PC card, go to [Socket Status] (in [Start] - [Settings] - [Control Panel] - [PC Card (PCMCIA)]), select the PC card slot and press [Stop].

- 2 Removing the PC card (or the dummy card)**

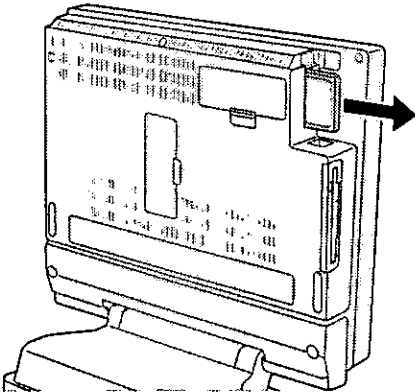

NOTE

Dummy cards are provided at the time of purchase. They provide protection for the PC card slots against such things as dust.

- **Installing the PC card**

Simply slide the PC card in until it snaps into place.
Please refer to the manual for each card on how to install the card.

NOTE

In case of a PC card with a cable, you can pass the cable through the hole of the computer. Do not pass a bold cable forcefully.

CAUTION

After you insert a PC Card, a message may appear instructing you to insert the Windows 95 CD-ROM. If this happens, press the [Browse] button, then type "c:\windows\options\cabs". If you have a floppy disk with a driver, insert the disk in the floppy disk drive, then type "a:".

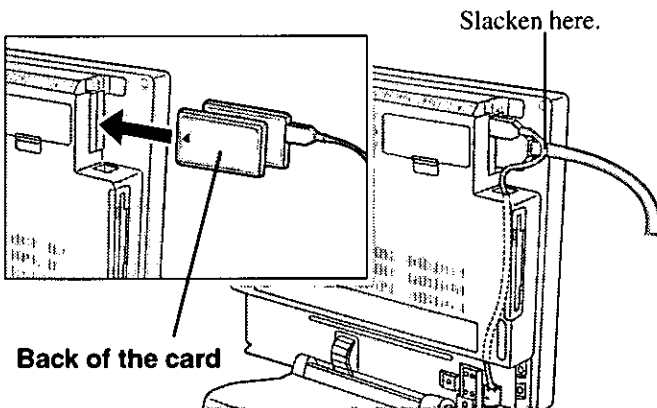

- 3 Turn your computer on**

NOTE

- You may need to install a driver from the Windows 95 CD-ROM (included) or a PC Card's floppy disk. Simply follow the on-screen instructions and read the PC Card's operation manual on how to install the driver.
- PhoenixCard Manager:**
- Follow the installation procedure below only if you will be using the ZV card. Otherwise, do not perform the installation; abnormal operation may result.
 - 1 Set the items of [Sound Chip] to [Automatic (PnP)] in the Setup Utility.
 - 2 Select [Start] - [Run] and type "c:\util\drivers\pccard\disk1\setup.exe", press , then follow the on-screen instructions.
- If the computer has been reinstalled, follow the instructions in "Installing PhoenixCard Manager95" on page 29.
- After PhoenixCard Manager95 has been installed, make sure to power off the computer before installing or removing the card. Also, do not use the suspend or hibernation functions if the card is installed.

Add-ons/Peripherals

Adding Memory

CAUTION

RAM modules are extremely sensitive to static electricity. There are cases where static electricity generated by the human body has adversely affected such modules. In addition, it is easy to damage the RAM modules or internal components of the computer. Therefore, when installing or removing a RAM module, handle the module with extreme care.

Installing/Removing the RAM Module

- 1 Power off your computer** (☞ page 11)
Do not shut down using the suspend or hibernation mode.

CAUTION

Do not install or remove peripherals while your computer is in the suspend or hibernation mode; abnormal operation may result.

- 2 Remove the memory cover**

CAUTION

Do not touch the terminals or internal components, insert objects other than the module, or allow foreign particles to enter. Doing so has been known to cause damage, fire or electric shock.

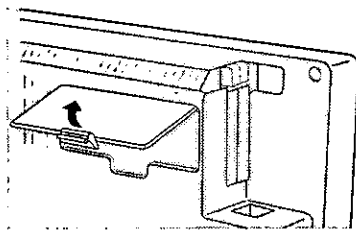

- 1** Slide the module in at an angle.

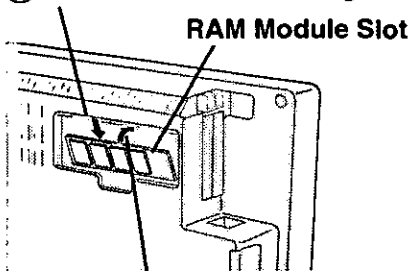

- 2** Snap the module into place by pushing it down.

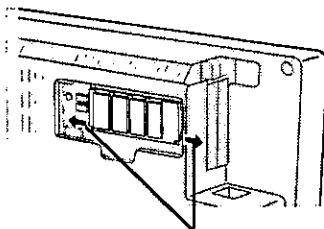

Open the left and right hooks.

Fix the hooks

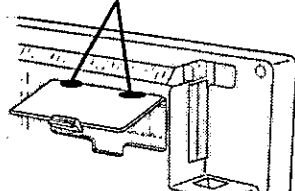

- 3** ● Installing the RAM module

RAM module specifications

144 pins, 60/70 ns, 3.3 V, SO-DIMM, EDO

31.7 mm (1.25")
or less

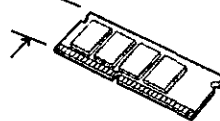

- Removing the RAM module

- 4** Put the cover back into place

- 5** Turn your computer on

Using an External Display

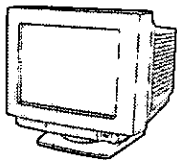

Some external display connectors do not match the computer's connector. In this case, consult your nearest Panasonic dealer.

Ext. Display Port

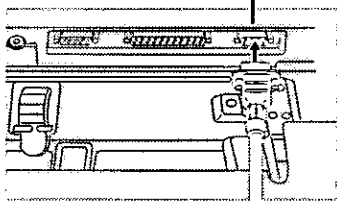

Be careful with the direction of the connector.

- 1 Power off your computer** (☞ page 11)
Do not shut down using the suspend or hibernation mode.

CAUTION

Do not install or remove peripherals while your computer is in the suspend or hibernation mode; abnormal operation may result.

- 2 Connect the external display to your computer**

NOTE

For more detailed information, please refer to the operation manual for the external display.

- 3 Turn on the display, then turn on your computer**

- **To display on both the LCD of your computer and the external display**

After this settings, [True Color (24bit)] can not be displayed on the external display.

- 1 Run the Setup Utility** (☞ page 34).
- 2** Using and , select [System Setup] then press .
- 3** Using and , select [Display], set [Simultaneous] with then press .
- 4 Close the Setup Utility** (☞ page 34).
- 5 Select your external display**
Set your external display for [Models] in [Start] - [Settings] - [Control Panel] - [Display] - [Settings] - [Advanced Properties] - [Monitor] - [Change] - [Show all devices], then press .

Using a Printer



Parallel Port

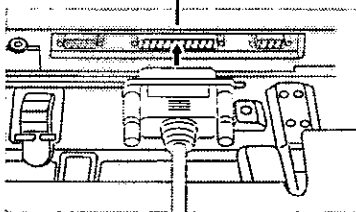

Be careful with the direction of the connector.

- 1 Power off your computer** (☞ page 11)
Do not shut down using the suspend or hibernation mode.

CAUTION

Do not install or remove peripherals while your computer is in the suspend or hibernation mode; abnormal operation may result.

- 2 Connect the printer to your computer**

- 3 Turn on the printer, then turn on your computer**

- 4 Setting your printer**

Go to [My Computer] - [Printers]. Find your printer's icon, double-click on it, and click [File] - [Set As Default]. If no icon is available, select [Add Printer] and install the driver program.

NOTE

You may need to install a driver for your printer. Simply follow the on-screen instructions and read the printer's operation manual on how to install the driver.

Storage, Carrying and Maintenance

Computer

Maintenance

- Do not use solutions such as benzene or thinner. A soft, dry cloth is recommended.
- Cleaning the CD drive using a CD lens cleaner is recommended, not a liquid type cleaner.

Carrying

- Do not leave a floppy disk in the drive while transporting your computer.
- Do not carry your computer when it is ON.
- Do not hold the edges of the display. Doing so may damage the computer.



- Do not drop or hit your computer against solid objects.
- If you have occasion to ship your computer, make absolutely sure that it is packed with adequate protection.
- Insert the lens protect sheet in the CD drive.

Storage

- Do not place in areas exposed to direct sunlight or extremely high/low temperatures.
- Insert the lens protect sheet in the CD drive.

Mouse

If the mouse cursor does not move, or skip erratically, dust may have built up in the track ball well. Cleaning the mouse is recommended.

1 Remove the mouse

Power off your computer then remove the mouse.

2 Remove the cover and then remove the ball

Turn the mouse over, turn the ring counterclockwise while holding the two marks on the cover to unlock.

Remove the cover by sliding the mouse, then remove the ball.

3 Wash the ball and then wipe the cover and roller

After washing the ball in soapy water, rinse it in water thoroughly and wipe it with a dry, soft cloth.

Wipe the surface of the cover and the roller in the mouse with a dry, soft cloth as well.

4 Return the ball and cover

Return the ball to its original position, attach the cover and turn it clockwise to lock.

5 Return the mouse

Return the mouse to its original position.

Marks

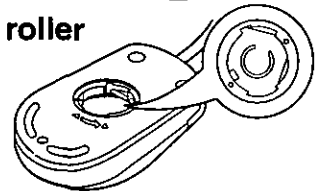
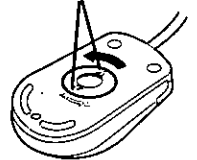

CD-ROM

- Do not allow CDs to become dirty or scratched.
- Do not place or store CDs in locations exposed to heat, direct sunlight, humidity or dust.
- Do not write on the surface of the CD with ball-point pen or other writing instrument.
- Do not drop, bend, or place heavy objects on top of CDs.
- If the CD is brought from cold into a warm environment, moisture may form on the disc. Wipe this moisture off with a soft, dry, lint-free cloth before using the CD.
- Cleaning the CD using a CD disk cleaner (LF-K022DC) is recommended once every 2 or 3 months.

If a CD gets dirty, after wiping the CD with a moist, soft cloth, wipe it with a dry cloth. Always wipe from the center toward the edge.



Computer Diagnosis

List of Error Codes

If a problem occurs with your hardware, [POST Start up Error(s)] is displayed along with the error code(s), follow the on-screen instructions.

Setup: Setup utility (☞ page 34) is started. Run [Load Default Settings (PnP)].
Next the Setup Utility must be run again to input the appropriate operating environment settings.

Exit: Ignore the error message(s), and restart the computer.

Code	Description
062	Boot failure--default configuration used
101	System Board Failure
102	System Board Failure
106	System Board Failure
114	Adapter ROM Error
151	System Board Failure
161	Bad CMOS Battery
162	Configuration Change Has Occurred
162	Configuration Error
163	Date and Time Incorrect
173	Configuration Change Has Occurred
201	Memory Size Error
301	Keyboard Error
303	Keyboard Error
604	Diskette Drive Error
605	Diskette Drive Error
1780	Hard Disk Error
1800	PCI Error
1801	PCI Error
1802	PCI Error
1803	PCI Error
1804	PCI Error
1805	PCI Error
8601	Pointing Device Error
I9990301	Hard disk failure
I9990305	An operating system could not be found

Using the Self-diagnosis Program

Follow the procedure below to check whether each part of your computer is operating properly.







- 1** To run the program, insert the Firstaid FD you created into the floppy disk drive, then turn your computer on
- 2** When the display below is shown, select [1. Boot]
 1. Boot
 2. Restore HDD to factory default (For beginners)
 3. Restore HDD to factory default (For advanced users)
- 3** At the MS-DOS prompt (A:\WINDOWS\COMMAND>), input the following:
diag55 
Follow the messages on the screen.

Dealing with Problems



When a problem occurs, please refer to this page. If you think it has to do with the software application you are using, please read the related manual. If you cannot find a solution to a problem, please consult your nearest Panasonic dealer.

● Starting Up

If the fan (☞ page 37) in the back of the computer does not work, it may be a malfunction. Consult your nearest Panasonic dealer.

<p>The power indicator is not lit</p>	<ul style="list-style-type: none"> ● The AC adapter may not be properly connected. ● Pressing the reset button will solve the problem (☞ page 36).
<p>The power indicator is flashing orange and power remains OFF</p>	<p>The CPU temperature is too hot. When the temperature of the CPU drops, power on again.</p>
<p>[Enter Password:] or  is displayed</p>	<p>Please input your password. If you have forgotten it, consult your nearest Panasonic dealer.</p>
<p> is not displayed (Once this icon is executed,  will not be displayed later)</p>	<p>If you deleted  before you double-click , select [Start]-[Run], input [c:\util\avapp\psetup.bat], and press . Follow the message on the screen.</p>
<p>[Post Start Up Error(s)] is displayed</p>	<p>☞ page 23</p>
<p>The pre-memory count, Windows startup, or an operation is extremely slow</p>	<p>Run [Load Default Settings (PnP)] in the Setup Utility. This will restore the Setup Utility's settings to their default values (except the password settings), then the Setup Utility must be run once again for you to input the appropriate operating environment settings. (The processing speed depends on the application software used, so this operation may not cause the processing speed to increase.)</p>
<p>The date and time are incorrect</p>	<ul style="list-style-type: none"> ● You can set the date and time through [Date/Time] in [Start] - [Settings] - [Control Panel]. Another way is with the DATE and TIME commands in MS-DOS. ● If you continue to experience problems, the internal battery maintaining the clock may need to be replaced. Please consult your nearest Panasonic dealer.

● Display

<p>Even after powering on, no display</p>	<ul style="list-style-type: none"> ● Adjust the brightness or contrast. ● When purchasing the computer, the display setting has been preset for an external display. ● When there is no display to an external display, <ul style="list-style-type: none"> • Check your cable connection for an external display. • Confirm an external display is on. ● If your computer is connected to an external display and the internal LCD has been set to "off", and the unit is placed in the hibernation or suspend mode, the internal LCD will remain in the "off" mode if the external display is not connected when the computer is restarted. In this case, re-connect the external display and reboot the computer.
<p>The power has not been cut, but after a certain period of time, there is no display</p>	<ul style="list-style-type: none"> ● Has your computer been set to the power-saving mode? To resume operation of your computer, press any key. ● To save power, your computer may have automatically entered the suspend or hibernation mode.
<p>An afterimage appears</p>	<p>If an image is displayed for a prolonged period of time, an afterimage may appear. This is not a malfunction. The afterimage will disappear when a different screen is displayed.</p>
<p>The motion of a mouse cursor is not smooth</p>	<p>[Start]-[Settings]-[Control Panel]-[Mouse]-[Motion] and check [Show pointer trails].</p>
<p>The cursor does not move from mouse operations</p>	<ul style="list-style-type: none"> ● The Coffee break Password may be set. ● Check your mouse connections, and then reboot the computer from the keyboard. <p>From the keyboard, you may choose to press down on  or  +  then select [Shut Down].</p>

● Disk Operations

Cannot read/write to a floppy disk	<ul style="list-style-type: none"> ● Has the floppy disk been correctly inserted? ● Has the floppy disk been correctly formatted? ● Has the Setup Utility been used to set [Floppy Operation] to [Enable]?
Unable to write to a floppy disk	Is the floppy disk write-protected?
How to format a floppy disk is unclear	Select [Format] in [My Computer] - [3 1/2 Floppy (A:)] - [File]. After confirming the disk volume and format type, click <input type="button" value="Start"/> .
Unable to read/write to the hard disk	<ul style="list-style-type: none"> ● Your drive or file may not have been properly set. ● Check to see if the hard disk is full. ● Your hard disk content may be corrupted. Consult your nearest Panasonic dealer.
The Tray of the CD drive does not extend	<ul style="list-style-type: none"> ● Is the computer on? ● Extend the tray by using emergency hole. (☞ page 9)
Unable to read the CD	<ul style="list-style-type: none"> ● Is the CD dirty, wet or scratched? (☞ page 22) ● Has the CD been inserted correctly? ● Check the specification of the drive or file.

● Character Input

Only capital letters are being input	If the CapsLk lamp is lit, the Caps Lock is ON. To switch it OFF, press <input type="button" value="CapsLock"/> .
How to input European characters (ß, à, ç) or symbols is unclear	Select [Start] - [Run], input [c:\windows\charmap.exe] and press <input type="button" value="OK"/> . The Character Map will be displayed. Point to the desired font name and select it.

● Setup Utility

[Enter Password:] or <input type="button" value="OK"/> is displayed	Enter the User Password or Supervisor Password. If you have forgotten it, consult your nearest Panasonic dealer.
[User Password] cannot be selected	[User Password Protection] in [Supervisor Setup] may be enabled.
[Coffee break Password] or [Key Combination for Coffee break] cannot be selected	You need to set the User Password.
[Supervisor Password] cannot be set	If the User Password has been set first, the Supervisor Password can not be the same as the User Password. Another password needs to be entered.

Dealing with Problems

● Connecting Peripherals

Your peripheral does not work. An error occurs while installing the driver	You need to use drivers conforming to Windows 95 Version 4.00.950B (OSR-2). Some earlier drivers will no longer work. For more information, please ask the source of the driver in question.
Unable to print	<ul style="list-style-type: none"> ● Check the computer-printer connection. ● Make sure the printer is on. ● Make sure the printer is in the online state. ● Make sure paper is in the printer tray and there is no paper jam. ● Has the Setup Utility been used to set [Parallel Port (Address)] to [Automatic (PnP)], [378] or [3BC]?
The device connected to the serial port does not work	<ul style="list-style-type: none"> ● Check the connection. ● Confirm that the device driver for the serial port works. Please refer to the reference manual for the device. ● Confirm that two mouse devices are not connected, one through the mouse jack and the other through the serial port. ● Has the Setup Utility been used to set [Serial Port] to [Automatic (PnP)] or [3F8]?
A PC card does not work	<ul style="list-style-type: none"> ● Make sure the card is properly inserted. ● Confirm that the card conforms to the PC Card Standard. ● A driver for Windows 95 may need to be installed. ● Note that after a driver is installed, the computer must be rebooted. ● Check that the proper port settings have been made. ● Read the PC card's manual. Or, you may need to call the source of the PC card.
You do not know the available RAM module	☞ page 20
The RAM module has not been recognized	Make sure the RAM module has been properly inserted.
The address map for IRQ, I/O port address, etc. is unclear	Check the address map by going to [View Resources] in [Start] - [Settings] - [Control Panel] - [System] - [Device Manager] - [Computer] - [Properties].

Technical Information

Network

- The network connection may be severed when entering the standby and suspend (hibernation) mode. Be sure to disable the hibernation timeout settings with the Setup Utility if you require a network environment.
- When the power saving function is running, communications software may malfunction. For example, communications may be halted if the suspend mode (hibernation) is activated.

About HDD DMA Transfer

Do not add the check mark to [DMA] in [Start] - [Settings] - [Control Panel] - [System] - [Device Manager] - [Disk drives] - [GENERIC IDE DISK TYPE**] - [Settings].

This may damage data on the hard disk.

FAT32

This computer uses a new, highly efficient file system called FAT32. Please note the following regarding FAT32.

- Some software will not run normally:
Do not run disk utilities and other software not compatible with FAT32. Doing so could cause incorrect information such as hard disk capacity to be shown or could destroy hard disk data.

Contact the dealer or other outlet for the software and obtain the latest version.

- Non-recognition from other operating systems:
You will not be able to view the contents of your hard disk from other operating systems. (For example, you will not be able to view the contents of your hard disk even when starting up using a floppy disk created with another computer.)
Other operating systems cannot therefore be installed. To install the operating system, please refer to the method listed below. If you are unsure about this explanation, do not proceed with installation of operating system.

- ① Back up the contents of your hard disk.
- ② Start up with the Firstaid FD.

- ③ When the [Windows 95 Startup Menu] appears, select [1. Boot].
- ④ Enter FDISK .
- ⑤ Select [3. Delete partition or Logical DOS Drive].
- ⑥ Select [1. Delete Primary DOS Partition].
- ⑦ Start up again following the instructions on the screen.

These steps will allow you to install most operating systems. The contents of the hard disk will be deleted. Always make sure to back up the hard disk beforehand.

The following steps will normally be unnecessary, however, if installation is not possible, try performing them.

- ⑧ Start up again using the Firstaid FD to open FDISK in the same way.
- ⑨ When [Do you wish to enable large disk support (Y/N)...?] appears on the first screen, press "N", then .
- ⑩ Select [1. Create DOS partition or Logical DOS Drive].
- ⑪ Set the partition following the instructions on the screen and activate it.
- ⑫ Start up again following the instructions on the screen.

Internet Explorer 4.0

Internet Explorer 4.0 places a tremendous load on the system in order to execute the wide variety of functions that it provides. As a result, some unexpected faults may occur.

- Example:
- It takes a long time to reboot or the computer locks up.
 - The software cannot be upgraded.
 - A system module error occurs.

If any of these faults occurs, try using the software with some Internet Explorer 4.0 functions turned off. (See Internet Explorer Help for more details.)

- Example:
- Close the channel bar.
 - Close the welcome message.
 - Set the wallpaper to "None".
 - Uninstall Internet Explorer 4.0.

Reinstallation

When Windows is started up while pressing the key, the [Microsoft Windows 95 Startup Menu] is displayed. After

reinstalling Windows, [Previous version of MS-DOS] also appears in this menu, however, do not select this item as MS-DOS is not installed.

Power saving function in the sound chip

The sound chip has its own power saving function. You can enable this function in the [OPL3-SAx power management] tab (select [Start] - [Settings] - [Control Panel] - [Power]).

In [Non Power Save mode], the power saving function is disabled. This is the default value.

In [Minimum level of power save], the power saving function is

enabled. You may encounter problems, such as no sound from music CDs, and the keyboard's volume control (+) will not function.

Do not select [Intermediate level of power save] or [Maximum level of power save] because noise is likely.

Reinstalling Software

Before Reinstallation

● Preparing

You will need the Firstaid FD (you earlier made copies of), Firstaid CD (included), Windows 95 CD (only use enclosed CD) and a blank floppy disk for the startup disk.

NOTE

If you have not created these disks, a message will appear at startup urging you to make backup copies. If there is no message, backup copies have already been created.

● Important

- Save all important data. If reinstallation is carried out, all data existing prior to the installation will be lost. The reinstallation will return the computer to factory condition.
- Be sure to remove all PC Cards and disconnect all peripherals before the reinstallation procedure.

Reinstalling

● Windows 95 (HDD format)

Two options are available, one for beginners and the other for advanced users.

- **For beginners:** Returning to factory default condition.
- **For advanced users:** Returning drive C to factory default condition.

CAUTION

- The Advanced Users option should only be performed when the hard disk has been formatted into two or more partitions.
- If data on your hard disk is compressed, the data should be uncompressed.

- 1 Insert the "Firstaid FD", and turn the computer on, then run the Setup Utility program. (☞ page 34)
- 2 Select [Load Default Settings (PnP)], then press . At the confirmation message, press .
- 3 Close the Setup Utility (☞ page 34); this screen should appear.

```
Microsoft Windows 95 Startup Menu
1. Boot
2. Restore HDD to factory default (For beginners)
3. Restore HDD to factory default (For advanced users)
Enter a choice: 1
```

- 4 **For beginners:** select [2. Restore HDD to factory default (For beginners)].
For advanced users: select [3. Restore HDD to factory default (For advanced users)]

At the confirmation message, press . Simply follow the on-screen instructions.

5 <For beginners only>

When your computer prompts you to insert the "Firstaid CD", please do so. When the computer reboots, the startup menu will appear, select 2 and continue to follow the on-screen instructions.

6 <For beginners only>

When your computer prompts you to insert the "Firstaid FD", press . When the computer reboots, the startup menu will appear, select 2 and continue to follow the on-screen instructions.

- 7 When your computer prompts you to insert the "Windows 95 CD", please do so.

Windows 95 has setup started. Follow the on-screen instructions.

NOTE

- With the exception of the instruction below, please select all default values displayed by the Setup Wizard. Be sure to add the check mark ✓ for [Sound, MIDI, or Video Capture Card] at the [Analyzing Your Computer].
- Have a blank disk on hand to create a "Windows 95 Startup Disk". Immediately after creating this disk, enter the "Firstaid FD" into the floppy disk drive and press . (Note: A system error will result if the "Firstaid FD" is not inserted. If this occurs, insert the "Firstaid FD" and press [Retry].)

- 8 At the [Finishing Setup], remove the floppy disk and press . Windows will restart after all the settings have automatically been made.

- 9 At the [Date/Time Properties], press .

- 10 At the [Add Printer Wizard], press .

- 11 When the display appears indicating the establishment of the system settings, press . The computer will reboot. (When the welcome screen appears, press .

● Power 1

- 12 Delete the check mark ✓ for [When powered by AC power] in [Start] - [Settings] - [Control Panel] - [Power] - [Disk Drives], then press .

● Device Manager 1

- 13 Set [Start drive letter] and [End drive letter] in [Control Panel] - [System] - [Device Manager]- [CDROM]- [MATSHITA UJDCD8710]- [Settings] - [Reserved drive letters] to [L:], then press . If the message to restart or shut down Windows appears, select .

● Sound driver

14 In [Control Panel] - [System] - [Device Manager], for each item in [Sound, video and game controllers] and [Ports (COM&LPT)], press to delete it, then press to confirm the deletion. If the message to restart or shut down Windows appears, select .

15 Select . If the message to restart Windows appears, select . If the message does not appear, select [Start] - [Shut Down] - [Restart the computer], then press .

If [Unknown Device] appears at the [Update Device Driver Wizard] while restarting, select .

16 Select , input [c:\util\drivers\sound], then press .

17 At the [Update Device Driver Wizard], select , and at the [Insert Disk] select .

18 At the [Copying Files], type [c:\util\drivers\sound], then press .

● Video driver

19 In [Control Panel] - [System] - [Device Manager] - [Display adapters] - [Standard PCI Graphics Adapter (VGA)] - [Driver] - [Update Driver], select [Yes (Recommended)], then press .

20 Select , input [c:\util\drivers\video], then press .

21 At the [Update Device Driver Wizard], select .

22 If the message to restart Windows appears, select , then select at the [S3 Inc. Virge MX (Panasonic Release) Properties].

● Device Manager 2

23 For each item in [System] - [Device Manager] - [Other Devices] and [PCMCIA Sockets], select to delete it, then press .

24 Select the item [System devices] - [PCI bus], then select , then press . If the message to restart Windows appears, select .

● System setup 1

25 In [Start] - [Run], input [c:\install.bat] then press . Windows restart.

26 When the [Version Conflict] appears, select . If the message to restart Windows appears, select .

● Power 2

27 In [Start] - [Settings] - [Control Panel] - [Power] - [OPL3-SAX power management], set [Non Power Save mode] then press .

● Device Manager 3

28 Delete the check mark for [Auto insert notification] in [Control Panel] - [System] - [Device Manager] - [CDROM] - [MATSHITA UJDCD8710] - [Settings], then press . Press at the [System Properties]. If the message to restart Windows appears, select .

● Display

29 Set [Super VGA 1024 X 768] for [Models] in [Start] - [Settings] - [Control Panel] - [Display] - [Settings] - [Advanced Properties] - [Monitor] - [Change], then press .

After pressing at the [Advanced Display Properties], press .

● System setup 2

30 Select [Start] - [Programs] - [MS-DOS prompt], then type the following.

```
del \install.*   
exit 
```

NOTE

Some Windows applications differ in use from their factory-set state. To add or delete items from the menu, select [Add/Remove Programs] in [Start] - [Settings] - [Control Panel].

Installing PhoenixCard Manager

Please prepare two 2HD formatted floppy disks to create backup disks for PhoenixCard Manager95.

Select [Start] - [Program] - [MS-DOS prompt], then type the following.

For PhoenixCard Manager95 disk1:

```
xcopy c:\util\drivers\pccard\disk1 a:\ /s 
```

For PhoenixCard Manager95 disk2:

```
xcopy c:\util\drivers\pccard\disk2 a:\ /s 
```

If necessary, install PhoenixCard Manager95 with the following steps.

1 Insert the "PhoenixCard Manager95 disk1".

2 Select [Start] - [Settings] - [Control Panel] - [Add/Remove Programs].

3 Select [Install/Uninstall] - [Install] then press .

4 Press , then follow the on-screen instructions.

Installing Internet Explorer 4.0

If necessary, install Internet Explorer 4.0 with the following steps.

1 Insert the Internet Explorer CD-ROM.

2 In [Start] - [Run], input [L:\setup.exe], then press .

Follow the on-screen instructions.

LIMITED USE LICENSE AGREEMENT

THE SOFTWARE PROGRAM(S) ("PROGRAMS") FURNISHED WITH THIS PANASONIC® PRODUCT ("PRODUCT") ARE LICENSED ONLY TO THE END-USER ("YOU"), AND MAY BE USED BY YOU ONLY IN ACCORDANCE WITH THE LICENSE TERMS DESCRIBED BELOW. YOUR USE OF THE PROGRAMS SHALL BE CONCLUSIVELY DEEMED TO CONSTITUTE YOUR ACCEPTANCE OF THE TERMS OF THIS LICENSE.

Matsushita Electric Industrial Co., Ltd. ("MEI") has developed or otherwise obtained the Programs and hereby licenses their use to you. You assume sole responsibility for the selection of the Product (including the associated Programs) to achieve your intended results, and for the installation, use and results obtained therefrom.

LICENSE

- A. MEI hereby grants you a personal, non-transferable and non-exclusive right and license to use the Programs in accordance with the terms and conditions stated in this Agreement. You acknowledge that you are receiving only a LIMITED LICENSE TO USE the Programs and related documentation and that you shall obtain no title, ownership nor any other rights in or to the Programs and related documentation nor in or to the algorithms, concepts, designs and ideas represented by or incorporated in the Programs and related documentation, all of which title, ownership and rights shall remain with MEI.
- B. You may use the Programs only on the single Product which was accompanied by the Programs.
- C. You and your employees and agents are required to protect the confidentiality of the Programs. You may not distribute or otherwise make the Programs or related documentation available to any third party, by time-sharing or otherwise, without the prior written consent of MEI.
- D. You may not copy or reproduce, or permit to be copied or reproduced, the Programs or related documentation for any purpose, except that you may make one (1) copy of the Programs for backup purposes only in support of your use of the Programs on the single Product which was accompanied by the Programs. You shall not modify, or attempt to modify, the Programs.
- E. You may transfer the Programs and license them to another party only in connection with your transfer of the single Product which was accompanied by the Programs to such other party. At the time of such a transfer, you must also transfer all copies, whether in printed or machine readable form, of every Program, and the related documentation, to the same party or destroy any such copies not so transferred.
- F. You may not remove any copyright, trademark or other notice or product identification from the Programs and you must reproduce and include any such notice or product identification on any copy of any Program.

YOU MAY NOT REVERSE ASSEMBLE, REVERSE COMPILE, OR MECHANICALLY OR ELECTRONICALLY TRACE THE PROGRAMS, OR ANY COPY THEREOF, IN WHOLE OR IN PART.

YOU MAY NOT USE, COPY, MODIFY, ALTER, OR TRANSFER THE PROGRAMS OR ANY COPY THEREOF, IN WHOLE OR IN PART, EXCEPT AS EXPRESSLY PROVIDED IN THE LICENSE.

IF YOU TRANSFER POSSESSION OF ANY COPY OF ANY PROGRAM TO ANOTHER PARTY, EXCEPT AS PERMITTED IN PARAGRAPH E ABOVE, YOUR LICENSE IS AUTOMATICALLY TERMINATED.

TERM

This license is effective only for so long as you own or lease the Product, unless earlier terminated. You may terminate this license at any time by destroying, at your expense, the Programs and related documentation together with all copies thereof in any form. This license will also terminate effective immediately upon occurrence of the conditions therefor set forth elsewhere in this Agreement, or if you fail to comply with any term or condition contained herein. Upon any such termination, you agree to destroy, at your expense, the Programs and related documentation together with all copies thereof in any form.

YOU ACKNOWLEDGE THAT YOU HAVE READ THIS AGREEMENT, UNDERSTAND IT AND AGREE TO BE BOUND BY ITS TERMS AND CONDITIONS. YOU FURTHER AGREE THAT IT IS THE COMPLETE AND EXCLUSIVE STATEMENT OF THE AGREEMENT BETWEEN US, WHICH SUPERSEDES ANY PROPOSAL OR PRIOR AGREEMENT, ORAL OR WRITTEN, AND ANY OTHER COMMUNICATIONS BETWEEN US, RELATING TO THE SUBJECT MATTER OF THIS AGREEMENT.

Beschränkte Benutzerlizenz-Vereinbarung

Das (die) mit diesem Panasonic®-Produkt (im weiteren als "Produkt" bezeichnet) gelieferte(n) Programm(e) (im weiteren als "Programme" bezeichnet) wird (werden) nur für den Gebrauch durch den Endnutzer (im weiteren als "der Käufer" bezeichnet) lizenziert und darf (dürfen) ausschließlich gemäß den unten aufgeführten Lizenzbedingungen benutzt werden. Der Gebrauch der Programme durch den Käufer gilt als konkludente Zustimmung des Käufers zu den Bestimmungen dieser Lizenz.

Die Programme wurden von Matsushita Electric Industrial Co., Ltd. (im weiteren als "MEI" bezeichnet) entwickelt oder sie wurden auf andere Weise von MEI erworben, und MEI lizenziert die Programme hiermit für den Gebrauch des Käufers. Der Käufer übernimmt die alleinige Verantwortung dafür, daß die Wahl des Produkts (einschließlich der zugehörigen Programme) die beabsichtigten Zwecke erfüllt, sowie für die Installation, den Gebrauch und die damit erzielten Ergebnisse.

Lizenz

- A. Hiermit erteilt MEI dem Käufer das persönliche, nicht übertragbare und nicht ausschließliche Recht und die Lizenz zur Nutzung der Programme gemäß den Bestimmungen und Bedingungen dieser Vereinbarung. Der Käufer bestätigt, daß er lediglich eine BESCHRÄNKTE LIZENZ ZUM GEBRAUCH der Programme und der dazugehörigen Dokumentation erhält und daß mit dieser Lizenz kein Rechtsanspruch, kein Besitzanspruch und keine anderen Rechte verbunden sind, weder auf die Programme und die dazugehörige Dokumentation, noch auf die Algorithmen, Konzepte, Ausführungen und Ideen, die von den Programmen und der dazugehörigen Dokumentation dargestellt werden oder in diese aufgenommen sind, und daß alle Rechte bei MEI verbleiben.
- B. Der Käufer darf die Programme nur mit genau dem Produkt verwenden, zu dessen Lieferumfang die Programme gehören.
- C. Der Käufer und seine Angestellten und Bevollmächtigten sind zum Schutz der Vertraulichkeit der Programme verpflichtet. Der Käufer darf die Programme und die dazugehörige Dokumentation ohne vorherige schriftliche Genehmigung von MEI nicht an Dritte weitergeben oder sie auf andere Weise, einschließlich von Time-Sharing, Dritten zugänglich machen.
- D. Der Käufer darf die Programme und die dazugehörige Dokumentation zu keinerlei Zwecken kopieren oder reproduzieren und darf auch nicht zulassen, daß sie von anderen kopiert oder reproduziert werden, außer daß der Käufer eine (1) Kopie der Programme ausschließlich für Sicherungszwecke und nur zur Unterstützung der Verwendung der Programme mit genau dem Produkt erstellen darf, zu dessen Lieferumfang die Programme gehören. Der Käufer darf die Programme weder modifizieren noch solche Modifikationen versuchen.
- E. Der Käufer darf die Programme und eine diesbezügliche Benutzerlizenz nur zusammen mit der Übergabe genau des Produktes, zu dessen Lieferumfang die Programme gehören, an einen Dritten übergeben. Zur Zeitpunkt einer solchen Übergabe ist der Käufer verpflichtet, sämtliche von ihm erstellten Kopien, sowohl in gedruckter, als auch in Maschinensprache abgefaßter Form, jedes einzelnen Programms und der dazugehörigen Dokumentation an die gleiche Person zu übergeben und alle nicht übergebenen Kopien zu zerstören.
- F. Der Käufer darf kein Copyright, Warenzeichen oder keine andere Bekanntmachung oder Produktkennzeichnung von den Programmen entfernen und muß jede solche Bekanntmachung oder Produktkennzeichnung auf jeder Kopie eines der Programme reproduzieren.

Der Käufer darf die Programme und davon erstellten Kopien, weder insgesamt noch teilweise, nicht im Reversierverfahren assemblieren, kompilieren oder auf mechanischem bzw. elektronischen Wege abtasten. Der Käufer darf die Programme und deren erstellte Kopien, weder insgesamt noch teilweise benutzen, kopieren, modifizieren, verändern oder weitergeben, es sei denn dies ist im Rahmen dieser Lizenz gestattet.

Falls der Käufer eine Kopie eines der Programme, außer gemäß Absatz E, an Dritte weitergibt, wird diese Lizenz automatisch außer Kraft gesetzt.

Laufzeit der Lizenz

Diese Lizenz ist nur so lange gültig, wie der Käufer das Produkt zu eigen hat oder im Leasing-Verfahren betreibt, falls sie nicht vorher widerrufen wird. Der Käufer darf diese Lizenz zu einem beliebigen Zeitpunkt aufheben, indem er die Programme und die dazugehörige Dokumentation zusammen mit allen davon in jeglicher Form erstellten Kopien auf eigene Kosten zerstört. Diese Lizenz wird außerdem mit sofortiger Wirkung aufgehoben, wenn eine der oben aufgeführten Bedingungen eintritt oder der Käufer irgendetwas Bestimmungen oder Bedingungen dieser Lizenzvereinbarung verletzt. Der Käufer verpflichtet sich, nach einer solchen Aufhebung der Lizenz die Programme und die dazugehörige Dokumentation zusammen mit allen davon in jeglicher Form erstellten Kopien auf eigene Kosten zu zerstören.

Der Käufer bestätigt, diese Vereinbarung gelesen und verstanden zu haben, und verpflichtet sich, ihre Bestimmungen und Bedingungen einzuhalten. Der Käufer bestätigt weiterhin, daß es sich bei der vorliegenden Vereinbarung um eine vollständige und ausschließliche Aufzeichnung der Vereinbarung zwischen dem Käufer und MEI handelt, die alle Vorschläge oder früheren Vereinbarungen, in mündlicher oder schriftlicher Form, sowie jegliche Unterredungen zwischen dem Käufer und MEI in Bezug auf die Gegenstände der vorliegenden Vereinbarung ablöst.

Contrat de licence d'usage limité

Le(s) logiciel(s) (les "Logiciels") fournis avec ce produit Panasonic® (le "Produit") sont exclusivement concédés en licence à l'utilisateur ultime ("vous"), et ils ne peuvent être utilisés que conformément aux clauses contractuelles ci-dessous. En utilisant les logiciels, vous vous engagez de manière définitive à respecter les termes, clauses et conditions des présentes.

Matsushita Electric Industrial Co., Ltd. ("MEI") a mis au point ou obtenu les Logiciels et vous en concède l'utilisation par les présentes. Vous assumez l'entière responsabilité du choix de ce Produit (y compris des Logiciels associés) pour obtenir les résultats escomptés, ainsi que de l'installation, de l'utilisation et des résultats obtenus.

Licence

- A. MEI vous octroie par les présentes le droit et la licence personnels, non cessibles et non exclusifs d'utiliser les Logiciels conformément aux termes, clauses et conditions de ce Contrat. Vous reconnaissez ne recevoir qu'un droit limité d'utiliser les Logiciels et la documentation les accompagnant et vous vous engagez à n'obtenir aucun droit de titre, propriété ni aucun autre droit vis-à-vis des Logiciels et de la documentation les accompagnant ni vis-à-vis des algorithmes, concepts, dessins, configurations et idées représentés par ou incorporés dans les Logiciels et la documentation les accompagnant, dont les titres, propriété et droits resteront tous à MEI.
- B. Vous ne pouvez utiliser les Logiciels que sur le Produit unique qui est accompagné par les Logiciels.
- C. Vous et vos employés ou agents êtes requis de protéger la confidentialité des Logiciels. Vous ne pouvez ni distribuer ni mettre les Logiciels et la documentation les accompagnant à la disposition d'un tiers, par partage de temps ou de quelque autre manière que ce soit, sans l'autorisation écrite préalable de MEI.
- D. Vous ne pouvez ni copier ni reproduire ni permettre la copie ni la reproduction des Logiciels ni de la documentation les accompagnant pour quelque fin que ce soit, à l'exception d'une (1) copie des Logiciels à des fins de sauvegarde uniquement pour soutenir votre utilisation des Logiciels sur le Produit unique qui est accompagné par les Logiciels. Vous ne pouvez ni modifier ni tenter de modifier les Logiciels.
- E. Vous ne pouvez céder les Logiciels et en octroyer la licence à une autre partie qu'en rapport avec votre cession du Produit unique qui est accompagné par les Logiciels à cette autre partie. Au moment de cette cession, vous devez céder également toutes les copies, que ce soit sous forme imprimée ou lisible par la machine, de tous les Logiciels ainsi que de la documentation les accompagnant, à la même partie ou détruire les copies non cédées.
- F. Vous ne pouvez retirer aucune marque de droits d'auteur, marque ou autre ni aucune identification de produit des Logiciels et vous devez reproduire et inclure toutes ces notices ou identifications de produit sur toutes les copies des Logiciels.

Vous ne pouvez assembler en sens inverse, compiler en sens inverse ni retracer les Logiciels ni aucune de leurs copies, de façon électronique ou mécanique, en tout ou en partie.

Vous ne pouvez utiliser, copier, modifier, altérer ni céder les Logiciels ni aucune de leurs copies, en tout ou en partie, à l'exception de ce qui est expressément stipulé dans ce contrat.

Si vous cédez la possession de toute copie ou de tout Logiciel à une autre partie, à l'exception de ce qui est autorisé au paragraphe E ci-dessus, votre licence est automatiquement résiliée.

Termes, clauses et conditions

Cette licence n'est effective que pour la durée de possession ou de crédit-bail du Produit, à moins d'une résiliation antérieure. Vous pouvez résilier cette licence à tout moment en détruisant, à vos frais, les Logiciels et la documentation les accompagnant avec toutes leurs copies, sous quelque forme que ce soit. Cette licence sera également résiliée, avec application immédiate, si les conditions de résiliation définies ailleurs dans ce contrat se sont réalisées ou si vous ne respectez pas les termes, clauses et conditions qui y sont contenues. Au moment de la résiliation, vous acceptez de détruire, à vos frais, les Logiciels et la documentation les accompagnant avec toutes leurs copies, sous quelque forme que ce soit.

Vous reconnaissez avoir lu ce contrat, en avoir compris toute la substance et avoir accepté de respecter ses termes, clauses et conditions. Vous reconnaissez en outre qu'ils sont la description complète et exclusive du contrat conclu entre nous, contrat qui remplace et annule toute proposition ou contrat précédent, écrit ou oral, et toute autre communication entre nous, relativement à l'objet du présent contrat.



Windows 95 Setup Procedure

This procedure explains step 8 on page 8 in more detail.

- 1** Select settings for your region, then press
- 2** Select your keyboard layout, then press
- 3** Enter your name and your company's name, and then press
The License Agreement will be displayed.
- 4** After reading the agreement, select [I accept the agreement] or [I don't accept the agreement] then press
If the former is selected, the [Certificate of Authenticity] will appear. If the latter is selected, the Windows setup will be aborted.
- 5** Input the Product Number written on the "Certificate of Authenticity" located in the "Introducing Microsoft Windows 95 book" that comes with this computer. After doing so, press
- 6** Press
- 7** If the instruction to restart appears, press
- 8** Insert the correct time, date and time zone and click
You can also make these settings at a later time.
- 9** If you want to complete the printer settings, press
Simply follow the instructions given on the display.
If not, press
You can also complete these settings at a later time.

Setup Utility

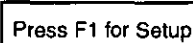
Running the Setup Utility

To run the Setup Utility, you need to restart your computer. → Upon seeing this message  → press 

NOTE

- Setup Utility does not run if you delay pressing . Restart Windows.
- If [Enter Password:] is displayed, enter your password.

<Main Screen>

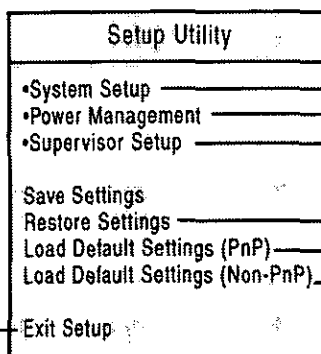

Return to the state existing at the time of Setup Utility startup, or to the settings saved with [Save Settings].

Set Default settings.









- (PnP) denotes "for Windows 95".
- (Non-PnP) denotes "for other than Windows 95".
- When the Supervisor Password has been set, input of the password is necessary.

Program Completion

- Hibernation settings (page 11)
 - Power Management settings (page 13)
 - Security Settings (page 14)
 - Add-ons/Peripherals Settings (page 18)
- After you have completed all settings, you may exit the Setup Utility program.

NOTE

Key Operations

- | | |
|--|--|
|  : To display the corresponding "help" file. |   : To move among the items. |
|  : To make a selection. |   : To move among the values of each item. |
|  : To display previous screen (To exit the program at the main screen). |  : To return to the setting before a change. |
| |  : To set the default values. |

Closing the Program

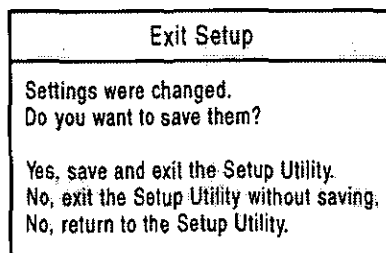

NOTE

If the User Password has been set, the password must be entered before Windows can start.

(The display may be different if no changes to the settings are made.)

System Setup	
Speaker	[Enable]
Display*1	[External Monitor]**1
• User Password	
Coffee break Password*2	[Enable]
Key Combination for Coffee break	[Alt+Ctrl+F9]

Setting the User Password (☞ page 14)
(Unable to select when the User Password Protection has been set.)

User Password	
User Password Status	Enable
Enter your new User Password twice.	
Enter User Password	[]
Enter User Password Again	[]
Set User Password	
Delete User Password	

Power Management	
Power Saving	[OFF]
CPU Speed Change Mode	Disable
HDD Motor Timeout	Never
Display Off Timer	Never
Power Switch	[On-Off]
Suspend/Hibernation Timeout*3	Never

☞ page 13

Sets the function of the power switch.

Able to set how long the interval will be until hibernation.

Supervisor Setup	
Parallel Port (Address)	[Automatic (PnP)]
Parallel Port (Data Direction)	[Bidirectional]
Serial Port	[Automatic (PnP)]
Sound Chip	[Enable]
Sound Blaster Compatible I/O	[Automatic (PnP)]
WSS CODEC I/O	[Automatic (PnP)]
Sound IRQ-A	[Automatic (PnP)]
Sound IRQ-B	[Automatic (PnP)]
Sound DMA-A	[Automatic (PnP)]
Sound DMA-B	[Automatic (PnP)]
Floppy Operation	[Enable]
Boot Up Drive	[FDD→HDD]
• Supervisor Password	
User Password Protection	[Disable]

Setting Supervisor Password (☞ page 17)

Supervisor Password	
Supervisor Password Status	Enable
Enter your new Supervisor Password twice.	
Enter Supervisor Password	[]
Enter Supervisor Password Again	[]
Set Supervisor Password	
Delete Supervisor Password	

*1 When no external display is connected, display will be through the LCD.

*2 Can only be selected when the User Password has been set.

*3 Can only be selected when [Power Switch] has been set [Suspend] or [Hibernation].

Names and Functions of Parts

● Front

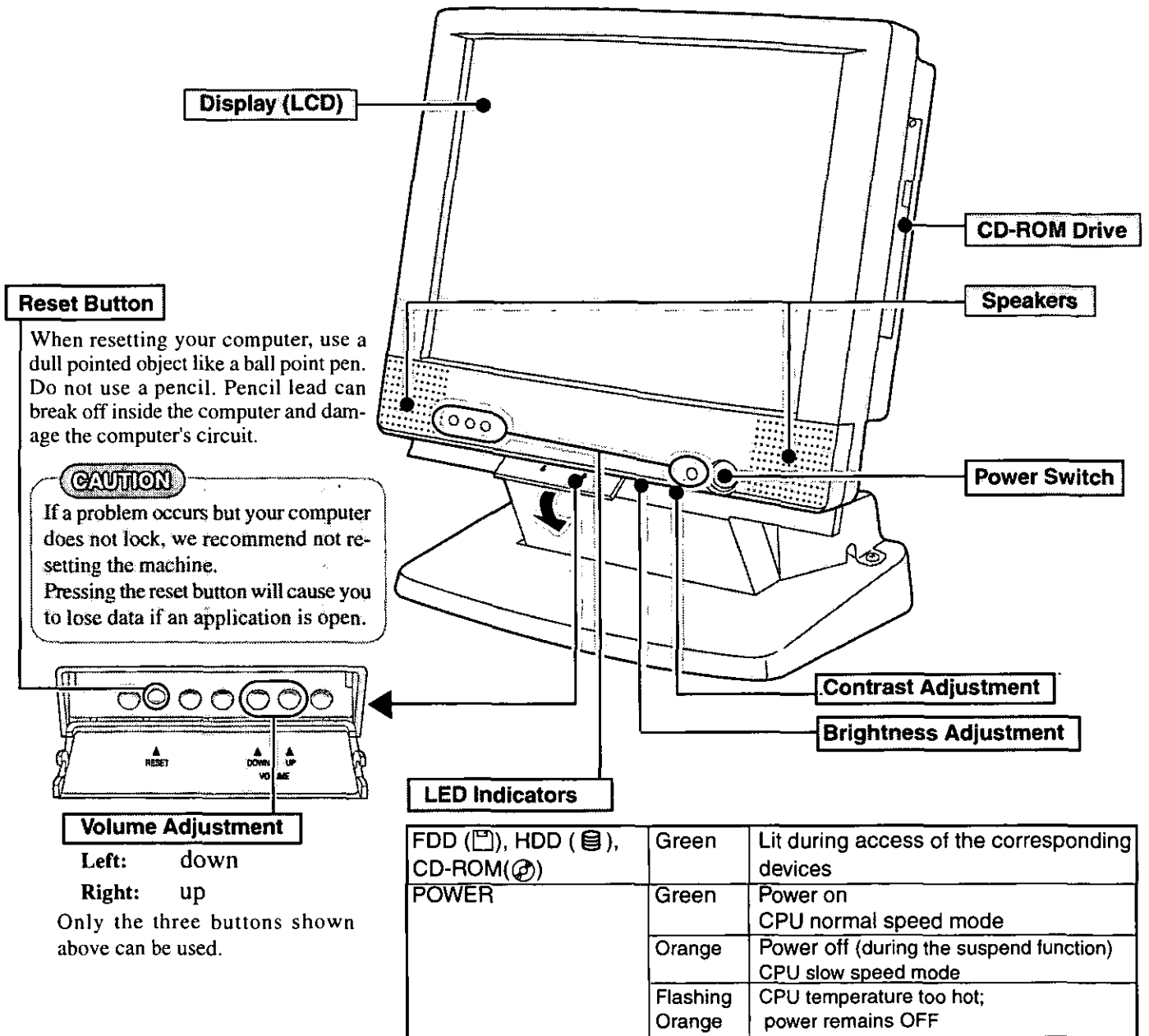

NOTE

When the temperature of the CPU rises, the processing speed is automatically reduced to protect the CPU from overheating. When the temperature of the CPU drops, the normal processing speed is automatically restored.

● Back

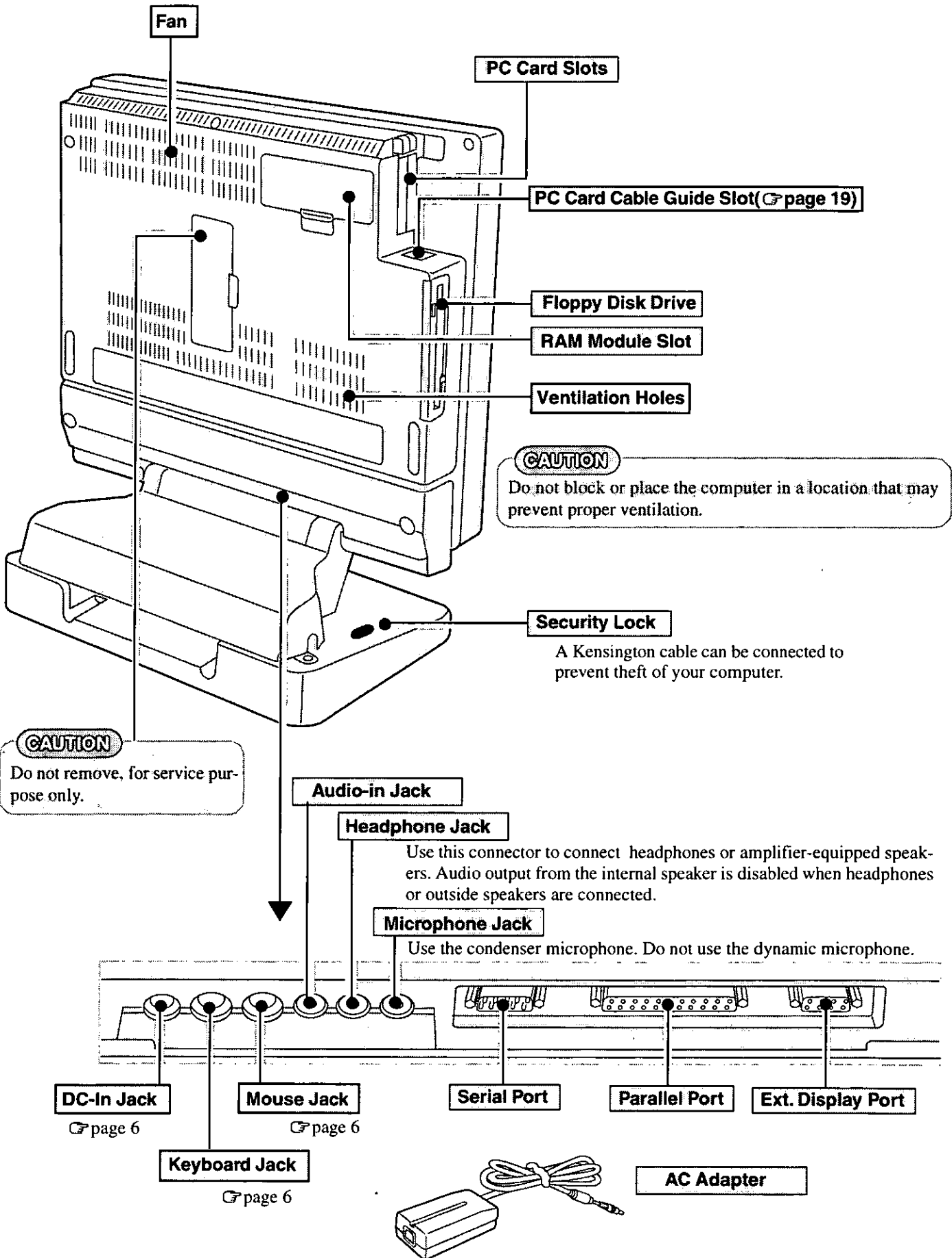

Specifications

● Main Specifications

Model No.	CF-55M5M8AM	
CPU	Pentium® Processor with MMX™ technology 200 MHz	
Cache Memory (second cache memory)	32 KB (256 KB)	
EDO Memory (Expandable to)	32 MB (96 MB Max.)	
Video Memory	2 MB	
LCD	Type	14.5" (TFT)
	Displayed Colors	256/65536
	Tilt Angle	3° to 25°
Hard Disk Drive (including about 110 MB used specifically by the system)	4.3 GB*	

* 1GB = 10⁹ bytes

● Other Specifications

Floppy Disk Drive	720 KB/1.44 MB (two-mode)		
CD-ROM Drive	10 x speed, Access time 250 ms.		
Slots	PC Card Slots	Two Type I or Type II, or one Type III CardBus / ZV Port (back slot) Compatible (Confirmation with the dealer required beforehand) ☞ page 18	
		Allowable current (total for two slots)	3.3 V: 400 mA, 5 V: 400 mA, 12 V: 120 mA
	RAM Module Slot	144-pin, 3.3-V, SO-DIMM, 31.7 mm(1.25") or less ☞ page 20	
Interface	Parallel Port	Dsub 25 pin female	
	Ext. Display Port	Mini Dsub 15 pin female	
	Serial Port	Dsub 9 pin male	
	Microphone Jack	Miniature jack, 3.5 DIA Input impedance 600 Ω, Input voltage range 0.01 Vp-p	
	Headphone Jack	Miniature jack, 3.5 DIA Impedance 32 Ω, Output Power 4 mW (Impedance 32 Ω) x 2	
	Audio-in Jack	Miniature jack, Stereo	
	Keyboard Jack	Mini DIN 6-pin female	
	Mouse Jack	Mini DIN 6-pin female	
Speaker	Stereo Speaker (built in)		
Sound	16 bits, 44.1 kHz PCM/FM sound (Sound Blaster PRO Compatible)		
Software	Operating System	Microsoft® Windows® 95 (FAT32 File System)	
	Utility Programs	Diagnostics program, PhoenixCard Manager95	
AC Adapter	Input	100 -240 V AC, 50 / 60 Hz	Output 15.0 V DC, 4.0 A
Power Consumption	Approx. 55 W** (Power Off: 1.2 W)		
Physical Dimensions (w x h x d)	364 mm X 392 mm X 209 mm (14.3" X 15.4" X 8.2")		
Weight	Approx. 6.6 kg (Approx. 14.6 lbs)		

Index

A

- AC adapter 6,7,37
- AC cord 6
- Angle of the display adjustment 7

B

- Boot Up Drive 16,35
- Brightness adjustment 36

C

- Carrying 22
- CD-ROM 9,22
- CD-ROM drive 9,22,36
- Coffee break password 15
- CPU 36,38
- CPU speed change mode 13
- Clicking 11
- Computer Viruses 5
- Conserving power 13
- Contrast adjustment 36

D

- Data protection 5,14
- DC-IN jack 37
- DIAG55 23
- Display 21,24,36
- Display off timer 13
- Double-clicking 11
- Dragging 11

E

- Emergency hole 9
- Enter password 10,14,16,24,25
- Error codes 23
- Ext. display port 21,37
- External display 21

F

- Firstaid CD 6,28
- Firstaid FD 6,8,23,27,28
- Floppy disk 5,8,16
- Floppy disk drive 37,38
- Floppy operation 16

H

- Hard disk drive (HDD) 5,36,38
- HDD motor timeout 13
- Headphone jack 37
- Hibernation function 11
- Hibernation timeout 13

I

- I/O port address 26
- IRQ 26

K

- Keyboard jack 37

L

- LCD 36
- LED indicators 36
- Limited use license agreement 30
- Load default settings 34

M

- Maintenance 22
- Microphone jack 37
- Mouse 6,11,22
- Mouse jack 6,37

N

- Network password 10

P

- Panasonic setup icon 8
- Parallel port 21,37
- PC Card 18
- PC Card slots 18,37
- Peripherals 18,26
- Power switch 8,36
- Printer 21

S

- Saving data 5
- Security lock 37
- Security measures 14
- Self-diagnosis program 23
- Serial port 37
- Setup utility 25,34
- Shutting down 11
- Speaker 36
- Starting up 10,24
- Storage 22
- Supervisor password 16
- Supervisor setup 16
- Suspend function 11
- Suspend timeout 13

R

- RAM module 20
- RAM module slot 20,37
- Reinstalling software 28
- Reset button 36
- Restarting 11

U

- User password 14

V

- Ventilation hole 37
- Volume 36

W

- Windows 95 setup 33
- Write-protect tab 5



As an ENERGY STAR Partner, Panasonic has determined that this product meets the ENERGY STAR guidelines for energy efficiency.

Outline of the International ENERGY STAR Office Equipment Program

The international ENERGY STAR Office Equipment Program is an international program that promotes energy saving through the use of computers and other office equipment. The program backs the development and dissemination of products with functions that effectively reduce energy consumption. It is an open system in which business proprietors can participate voluntarily. The targeted products are office equipment such as computers, displays, printers, facsimiles, and copiers. Their standards and logos are uniform among participating nations.

Free Manuals Download Website

<http://myh66.com>

<http://usermanuals.us>

<http://www.somanuals.com>

<http://www.4manuals.cc>

<http://www.manual-lib.com>

<http://www.404manual.com>

<http://www.luxmanual.com>

<http://aubethermostatmanual.com>

Golf course search by state

<http://golfingnear.com>

Email search by domain

<http://emailbydomain.com>

Auto manuals search

<http://auto.somanuals.com>

TV manuals search

<http://tv.somanuals.com>