

OWNER'S MANUAL

DPM[®] 4 /

DPM[®] 488

PEAVEY[®]

Macintosh®, *Alchemy™*, *Sound Designer™*, *Avalon™*, *Genwave™*, *Atari®*, *Sample Wrench™*, *Amiga®*, *Sample Vision™*, and *IBM®* are all trademarks of their respective companies.



Intended to alert the user to the presence of uninsulated “dangerous voltage” within the product’s enclosure that may be of sufficient magnitude to constitute a risk of electric shock to persons.



Intended to alert the user to the presence of important operating and maintenance (servicing) instructions in the literature accompanying the product.

CAUTION Risk of electrical shock — DO NOT OPEN!

CAUTION To reduce the risk of electric shock, do not remove cover. No user serviceable parts inside. Refer servicing to qualified service personnel.

WARNING To prevent electrical shock or fire hazard, do not expose this appliance to rain or moisture. Before using this appliance, read the operating guide for further warnings.

Contents

Introduction

WOW! THE DPM® SERIES KEYBOARDS	7
WHAT YOU GET WITH THE DPM 4 AND DPM 488	7
ABOUT THIS MANUAL	8
DPM 4 and DPM 488 Differences	9

Chapter 1: The Audio Connection

1.1 AUDIO HOOKUP	10
1.1a Cable Setup	10
1.1b I Just Wanna Hear the Demo!	10
1.1c Using the DPM as a “Workstation”	10
1.1d Live Use as a MIDI Keyboard/Master Controller	12
1.1e Studio Use with an External Sequencer	13
1.1f Powering Up	14
1.2 FRONT PANEL DESCRIPTIONS	14
1.3 QUICK PARAMETER SETUP	16
1.3a Auditioning Programs	16
1.3b Setting Parameters for Use as a MIDI Keyboard Driving a Second MIDI Module ...	17
1.3c Multi Mode: Setting Parameters for Studio Use with a Sequencer.....	18
1.4 ABOUT DYNAMIC ALLOCATION	18

Chapter 2: The Most Common DPM Operations

2.1 TUNING, KEYBOARD RESPONSE, AND VIEWING ANGLE EDITS	19
2.1a Global Tuning	19
2.1b Keyboard Velocity Response	20
2.1c Display Viewing Angle	20
2.2 MAIN MIDI EDITS	20
2.2a Change MIDI Input Channel	21
2.2b Change MIDI Output Channel	21
2.2c Change MIDI Mode	21
2.2d Enable Overflow Mode	21
2.2e Turn Local Control On or Off	22
2.2f Filter Out MIDI Data	22
2.3 STORAGE FUNCTIONS	23
2.3a Cartridge Memory Management	23
2.3b Format a Disk Prior to Saving Data	24
2.3c Saving Data to Disk and Naming Data Files	25
2.3d Loading Files from Disk	27
2.3e Deleting Files from Disk	28
2.3f Sending Data via MIDI System Exclusive Messages	29
2.4 EDIT MENU TWEAKS	30

2.4a	Save/Rename an Edited Program.....	30
2.4b	Change Overall Timbre (“Brighter/Duller”)	31
2.4c	Increase/Decrease Timbre “Dynamics”	31
2.4d	Change Program Volume Level.....	32
2.4e	Change Stereo Pan	33
2.4f	Set Pitch Bend Range.....	33
2.5	ASSIGN FOOTPEDAL AND FOOTSWITCH	34
2.6	MASTER EFFECTS SELECTION	35
2.7	INITIALIZE ENTIRE UNIT	36

Chapter 3: Creating Drum Kits

3.1	DRUM KIT BASICS	37
3.2	ACCESSING AND MODIFYING DRUM KIT PARAMETERS	37

Chapter 4: Programming the DPM

4.1	HISTORY AND BACKGROUND	40
4.1a	How the DPM Generates Sound: Analog Synthesizer Emulation and Sampling	40
4.1b	DPM Synthesizer Architecture	41
4.1c	Oscillators	42
4.1d	DCAs	42
4.1e	Pan	42
4.1f	Filters.....	42
4.1g	Output Stage.....	44
4.1h	Signal Processors	44
4.2	THE ART OF MODULATION	44
4.2a	About the DPM Modulation Matrix	44
4.2b	DPM Modulation Modules	46
4.3	DPM PROGRAMMING TECHNIQUES	46
4.3a	About the Compare Function	47
4.3b1	Wave Page 1	47
	Waveform Reference List	48
4.3b2	Wave Page 2 (Mods).....	49
4.3c1	Amplitude Page 1	49
4.3c2	Amplitude Page 2	50
4.3d1	Filter Page 1	51
4.3d2	Filter Page 2 (Mods)	52
4.3e1	Envelope Page 1 (Levels)	52
4.3e2	Envelope Page 2 (Level Mods).....	53
4.3e3	Envelope Page 3 (Times).....	54
4.3e4	Envelope Page 4 (Time Mods)	54
4.3f1	LFO Page 1	55
4.3f2	LFO Page 2 (Mods)	56
4.3g	Volume Page	57
4.3h1	Links Page 1	57
4.3h2	Links Page 2	59
4.3h3	Links Page 3	59

Chapter 5: Programming the On-Board Signal Processors

5.1 ABOUT DPM SIGNAL PROCESSING 61
 5.1a Effects Structure 61
 5.1b The Differences Between Effect 1 and Effect 2 62
 5.2 SIGNAL PROCESSORS IN MULTI CONFIGURATIONS 64
 5.3 FX PARAMETER PROGRAMMING 64
 5.3a Programming Signal Processing Parameters 65
 5.3b Reverb Parameter 66
 5.3c Delay Parameters 67
 5.3d Chorus Parameters 68
 5.3e EQ Parameters 69
 5.3f Gated Reverb 70
 5.3g Distortion Parameters 70
 5.3h Exciter Parameters 71
 5.4 COMBINATION EFFECTS OPTIONS 71

Chapter 6: Sequencing

6.1 BASIC OPERATION 73
 6.2 OVERVIEW OF SEQUENCER BUTTON FUNCTIONS 74
 6.3 SEQUENCE/SONG SELECTION 74
 6.4 GETTING READY TO RECORD A SEQUENCE 75
 6.5 SEQUENCER SYSTEM SETUP (CONTROL SCREEN) 76
 6.6 SEQUENCE EDIT FUNCTIONS 77
 6.6a Create a Sequence 77
 6.6b Delete a Sequence 78
 6.6c Copy a Sequence 78
 6.6d Choose a Sequence Effect 79
 6.6e Clear all Sequences 79
 6.7 SEQUENCE TRACK ASSIGNMENTS 79
 6.7a Assign Program to Track 80
 6.7b Track Configuration 80
 6.7c Track MIDI Output Assignment 81
 6.7d FX2 Send Assign 81
 6.7e Set Track Volume/Automated Mixdown 81
 6.8 RECORDING A SEQUENCE 82
 6.8a Transport Controls: Rewind, Play, Fast Forward, Stop, Pause 83
 6.8b Recording, Erasing, and Overdubbing Functions 84
 6.9 TRACK EDIT FUNCTIONS 85
 6.9a Erase Note and/or Controller Data 86
 6.9b Copy Note Data 87
 6.9c Transpose Note Data 89
 6.9d Scale Note Velocities 89
 6.9e Quantize Note Data 90
 6.9f Insert Measure Data 91

6.9g	Delete Measure Data	91
6.9h	Merge Tracks	92
6.9i	Slide Data	92
6.10	STEP EDITING	93
6.10a	Step Edit Operations	94
6.11	CONSTRUCTING A SONG	95
6.11a	Name/Save a Song	96
6.11b	Clear a Song	96
6.11c	Build a Song	96
6.11d	Song Building Options	97
6.11e	Building a Song	97
6.11f	Editing a Song	98

Chapter 7: Sample Editing

7.1	ABOUT SAMPLING	99
7.2	SAMPLE TRANSPOSITION	100
7.3	ABOUT MULTI-SAMPLING	100
7.4	MEMORY AND SAMPLE TIME	101
7.5	DEFINITION: WAVES AND SAMPLES	101
7.6	ABOUT SAMPLE LOOPING AND TRIMMING	101
7.7	ACCESSING SAMPLING FUNCTIONS	103
7.8	LOAD (SAMPLE FROM DISK)	103
7.9	SHOW (SAMPLE MEMORY STATUS)	105
7.10	RCV (RECEIVE A SAMPLE FROM AN SDS-COMPATIBLE DEVICE)	105
7.11	XMIT (TRANSMIT A SAMPLE TO AN SDS-COMPATIBLE DEVICE)	108
7.12	EDIT (EDIT SAMPLES IN MEMORY—LOOP AND TRIM)	109
7.13	DELETE (DELETE SAMPLES AND WAVES FROM MEMORY)	112
7.13a	Deleting Samples	112
7.13b	Deleting Waves	113
7.14	USING AN SX / SX II WITH THE DPM KEYBOARD	113
7.14a	RCV (Receive a Sample from an SX)	114
7.14b	RCV (Receive a Sample from an SX II)	116
7.15	SAMPLE MEMORY MANAGEMENT TIPS	119
7.15a	Sample Time Trade-offs	119
7.15b	The Sample/Patch Program Relationship	119
7.15c	The DPM as Sampler	119
7.15d	Additional Tips	120

Chapter 8: Advanced Applications

8.1	MIDI OVERFLOW MODE	121
8.2	ALTERNATE TUNING TABLES	121
8.2a	Selecting a Preset Tuning Table	122
8.2b	Creating Your Own Tuning Tables	123
8.2c	Alternate Even-Tempered Tuning	123
8.3	MIDI SYSTEM EXCLUSIVE STORAGE	124
8.3a	Saving SysEx Data to the DPM	124

8.3b	Reloading and Sending SysEx Data from the DPM	125
------	---	-----

Chapter 9: Programming Tips and Background Material

9.1	SEQUENCING BASICS	126
9.2	ABOUT ENVELOPE GENERATORS	127
9.3	CROSSFADE SYNTHESIS TECHNIQUES	130
9.3a	Automatic Crossfading	130
9.3b	Manual Crossfading	130
9.3c	Pressure-Controlled Crossfading	130
9.4	PROGRAMMING/EDITING TIPS	131
9.5	BLANK "TEMPLATE" PATCHES	133
9.6	ABOUT LEVELS AND DISTORTION	133
9.7	CARE OF FLOPPY DISKS	133

Chapter 10: MIDI Supplement

10.1	MIDI BASICS	135
10.2	MIDI HARDWARE	135
10.3	MIDI MESSAGE BASICS	136
10.4	CHANNEL MESSAGES	136
10.4a	Voice messages	136
10.4b	Mode messages	137
10.4c	Other messages	138
10.5	SYSTEM COMMON MESSAGES	138
10.6	BOOKS ON MIDI	139

Index

INDEX	140
-------------	-----

Introduction

WOW! THE DPM® SERIES KEYBOARDS

Welcome to the DPM® Series Performance Keyboards. The DPM 4 and DPM® 488 are the next logical steps in the evolution of Peavey Electronics' award-winning keyboard technology. The DPM 4 and DPM 488 combine some of the most desired features from their keyboard line to create a Performance Keyboard that is more powerful than ever (and still easy to use!). The DPM 4 and DPM 488 have 32 voice polyphony (that's double the DPM® 3!). The DPM 4 and DPM 488 also more than double the sample ROM to 10 megabytes. Best of all, the DPM 4 and DPM 488 are fully compatible with the existing DPM 3 sound and sample libraries!

The DPM 4 and DPM 488 feature a 10-megabyte set of on-board ROM samples. This new sample set was selected from the renowned Prosonus™, McGill™, and Northstar™ sample libraries. New waveforms include a highly improved acoustic piano, steel and nylon guitars, orchestral sections and solo instruments, orchestral percussion, brushed percussion, house drums, sound effects, and many more. In addition, the DPM 4 and DPM 488 feature expanded 32-voice polyphony, offering double the power to take advantage of these new sounds in sequencing and performance applications. Of course, the DPM 4 and DPM 488 also offer 512K of sample RAM (expandable to 1 MB), so custom samples can be added from disk, MIDI SDS, or from the DPM® SX™ Sampling Expander. Like the DPM 3, the DPM 4 and DPM 488 also feature remote control of the SX, with sample capture, looping and trimming, as well as dual effects processors, and an on-board 9-track, 20,000-note sequencer. And yes, any DPM 3 can be upgraded to DPM 4 specifications with a conversion kit.

WHAT YOU GET WITH THE DPM 4 AND DPM 488:

- 32-voice polyphony; 16-voice multi-timbral
- 24-bit programmable dual multi-effects processors
- 100 different musical instrument programs
- Ten 32-piece programmable drum kit locations
- Ten megabytes of internal factory samples (sample ROM)
- 512K RAM sample memory (expandable to 1 MB)
- Channel aftertouch
- Sample editing: looping, trimming, and mapping
- SX and SX™ II control screens and sample capture
- Full MIDI implementation (MIDI SDS compatibility)
- Stereo outputs
- 9-track, 20,000-note on-board sequencer
- DPM 3 sound library compatible
- 3.5" MS-DOS/ST-TOS compatible disk drive
- 40 x 2 backlit display
- Pitch wheel, mod wheel, programmable slider, data wheel
- Three assignable footswitch inputs (sustain, damper, etc.), with a separate CV pedal input
- Memory card slot for voice programs (DPM 4)
- 61-note keyboard with channel pressure (DPM 4)
- 88 velocity-sensitive "piano-weighted" keys (DPM 488)
- Beautiful polished hardwood cabinet (DPM 488)

...and much more, which you'll find out about as you read this manual.

Before we get started, it might be a good idea to fill out the warranty registration card and return it to Peavey. This way, we can let you know about our next fantastic keyboard!

ABOUT THIS MANUAL

We're shocked—you're actually reading it! Pat yourself on the back for validating someone's hard work. We will try to make it as quick and painless as possible to learn how to use your new DPM 4 or DPM 488 keyboard.

This manual contains two main sections:

Section 1, **The Works!**, details the background of synthesizers, explains all the details for using the DPM 4 and DPM 488 and even gives you some excellent sources for learning more about synthesis and MIDI. Here's a quick look at what this section contains:

Chapter 1, **The Audio Connection**, provides basic audio hookup instructions, and helps you get great sounds right out of the box.

Chapter 2, **The Most Common DPM Operations**: Here are the most common operations you'll do with the DPM—save and load files, change MIDI settings, edit often-used parameters such as pitch bend range, and so on.

Chapter 3, **Creating Drum Kits**: The DPM 4 and DPM 488 offer a full complement of drum sounds.

Chapter 4, **Programming the DPM**, shows how to create your own sounds or edit existing sounds; this presents the basics of sound programming as well as a reference section of programming parameters.

Chapter 5, **Programming the On-board Signal Processors**, explains how to take your sounds to the next level by learning how to program the DPM's signal processors.

Chapter 6, **Sequencing**: The on-board sequencer lets you compose on the DPM, drive other MIDI equipment, or both.

Chapter 7, **Sample Editing**: How to load, save, and edit samples.

Chapter 8, **Advanced Applications**: This chapter offers information on slaving multiple DPMs together, alternate tunings, and system exclusive data librarian functions.

Chapter 9, **Programming Tips and Background Material**, contains information about synthesis, disk care, envelope generator subtleties, programming tips, and other background material.

Chapter 10, **MIDI Supplement**: It is important to know the basics of the MIDI specification to make the best use of the DPM's MIDI features. If you are not very familiar with MIDI, please read the MIDI supplement before proceeding.

Beginners please note: Chapters 9 and 10 contain background material about synthesizers and programming. Grouping this material together allows those familiar with synthesis to use the body of the manual as a reference manual, yet background material is available for those who want it.

If you hate reading manuals, then Section 2 is for you. This section provides only the most essential information, in the form of tutorials, to make you an editing wizard (okay, maybe wizard is too much to hope for, but at least you will have a handy pull-out section and you won't have to carry five pounds of manual with your keyboard).

Section 2, **Tutorials**, are provided in the form of "Quick Start" cards called KeyStrokes. These provide a basic tutorial for all the "common" DPM 4 and DPM 488 functions. This is provided for users who don't really care about learning all the background details of synthesis (or already know all they need to) and just want to get to the good stuff. (Like how do I use this darn thing!)

This manual is designed to be a complete reference for DPM 4 and DPM 488 users. Section 2 assumes that you are familiar with the way synthesizers work. If you are a beginner, you may want to refer to the first section to help gain a better working knowledge of synthesizers and synthesis.

DPM 4 and DPM 488 Differences:

The DPM 4 and DPM 488 are identical except for the following:

- The DPM 4 has a data wheel for parameter manipulation and data entry.
- The DPM 4 has a memory cartridge slot.

- The DPM 488 has 88 keys.
- The DPM 488 has that really attractive polished hardwood cabinet (like you didn't already know that!).

That's it!

Throughout the rest of the manual, we will refer to the DPM 4 and DPM 488 as simply the DPM. If a section pertains to only the DPM 4 or DPM 488, we will point it out.

Let's have some fun!

Chapter 1: The Audio Connection

This chapter will provide basic connection/setup information (how to get the demo started!), show how to navigate the front panel, give you a quick look at parameter setup, and talk a little about dynamic voice allocation.

1.1 AUDIO HOOKUP

1.1a Cable Setup

1. Unpack the DPM. You should save all packing materials in case the unit needs to be sent for updating or servicing.
2. Plug the female end of the line cord into the matching socket on the DPM's rear panel.
3. With *all devices in your system turned off and the volume controls turned down*, hook up the connectors according to your particular needs, as described below.

1.1b I Just Wanna Hear the Demo!

1. Either run a mono cord from the Left/Mono Audio Output to your amplifier, or connect two mono cords from the Left and Right Audio Outputs to a stereo amp or two mixer inputs.
2. Turn on (in this order) the DPM, mixer (if present), and amplification system. Turn the volume controls up part way; turn them up to normal volume once you're satisfied that the system is working properly.
3. Press the **Select** Sequencer button. The display should show some sequence names. Press the button above one of the names in the display. If the display asks "Save last sequence edits?" press the button above the part of the display that says -NO-.
4. Press the **Play** Sequencer button (lower right area of the DPM front panel) to play the selected sequence. The sequence should start playing. If not, then the default parameters have been changed. Refer to Chapter 6 on sequencing for information on sequence playback.
5. After the demo has finished, press the **Stop** Sequencer button, even if the sequencer appears to be stopped.

1.1c Using the DPM as a "Workstation"

The DPM, thanks to its onboard signal processing and sequencer, can serve as a complete composition center that requires no equipment other than an amplifier or set of headphones. Hook it up as described next.

Audio: Referring to the diagrams below, plug the Audio Outputs into a suitable amplification system or mixer. You have three options:

- **Mono** Connect a mono cord from the Left/Mono Audio Output to a mono amplification system or individual mixer input.

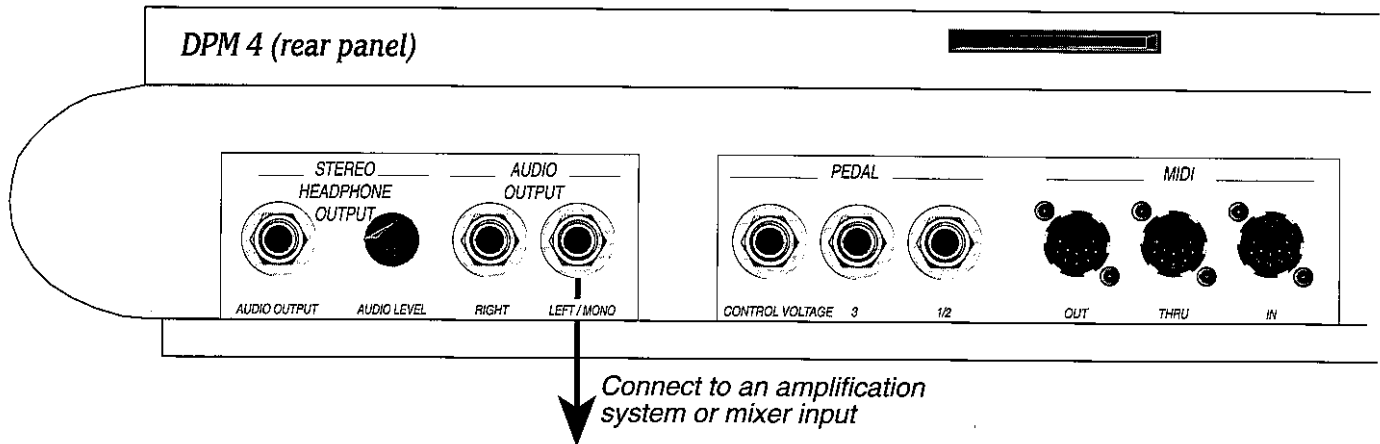

- **Stereo** Connect two mono cords from the Left and Right Audio Outputs to a stereo amplification system or two mixer inputs.

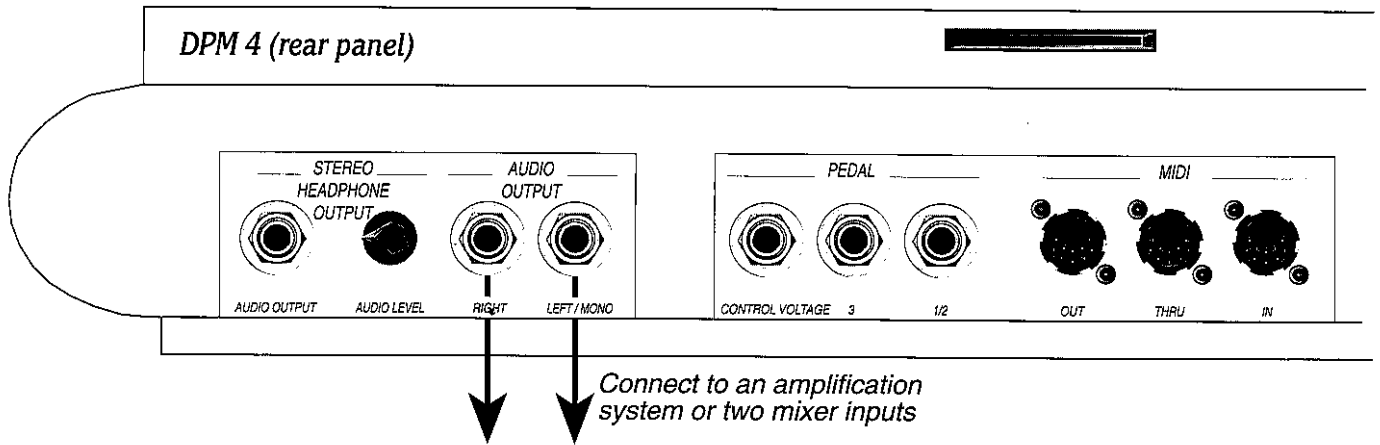

- **Stereo Headphones** Plug a set of high-quality stereo headphones into the rear panel headphone jack. A separate volume control regulates the headphone level.

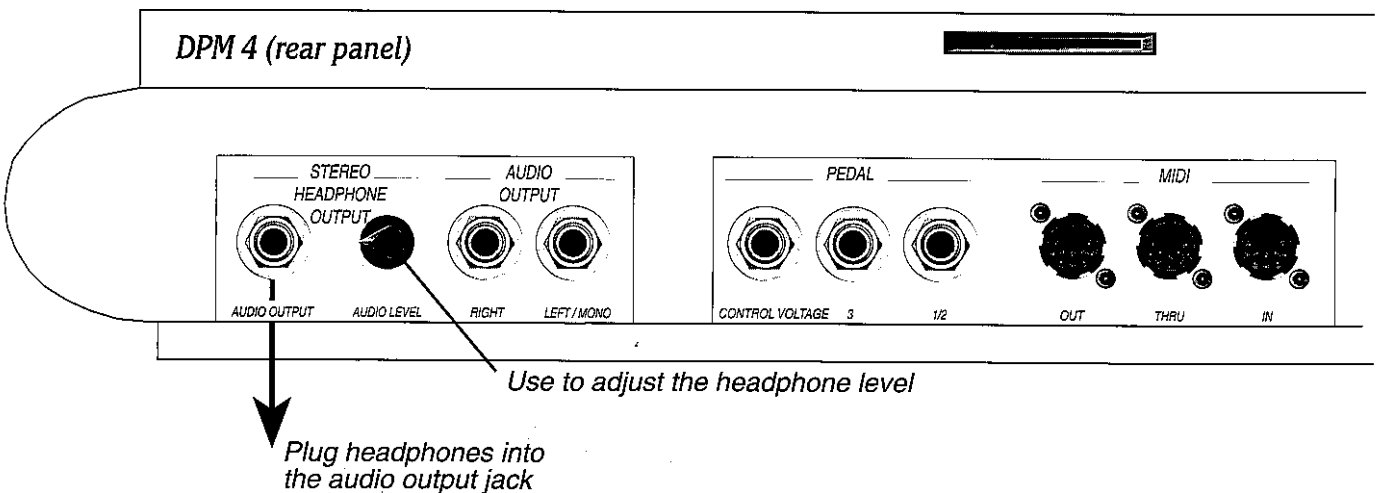

1.1d Live Use as a MIDI Keyboard/Master Controller

Most live applications use the DPM to generate sounds, with (possibly) the MIDI output driving other expander modules, such as a Peavey DPM V3 rack module.

Audio: Plug the Audio Outputs into a suitable amplification system or mixer. You have two options:

- **Mono** Connect a mono cord from the Left/Mono Audio Output to a mono amplification system or individual mixer input (see section 1.1c).
- **Stereo** Connect two mono cords from the Left and Right Audio Outputs to a stereo amplification system or two mixer inputs (see section 1.1c).

MIDI: When driving other MIDI units (e.g., expander module, MIDI-responsive signal processor, etc.) run a MIDI cable from the DPM MIDI Out to the 2nd unit's MIDI In. To drive additional MIDI modules from the same keyboard, patch the 2nd unit's MIDI Thru output to the 3rd module's MIDI In. Connect the expander module audio outputs to your amplification system via a mixer.

Caution: Do not attempt to connect more than three or four units together using MIDI Thru connections, as this may affect the integrity of the MIDI data.

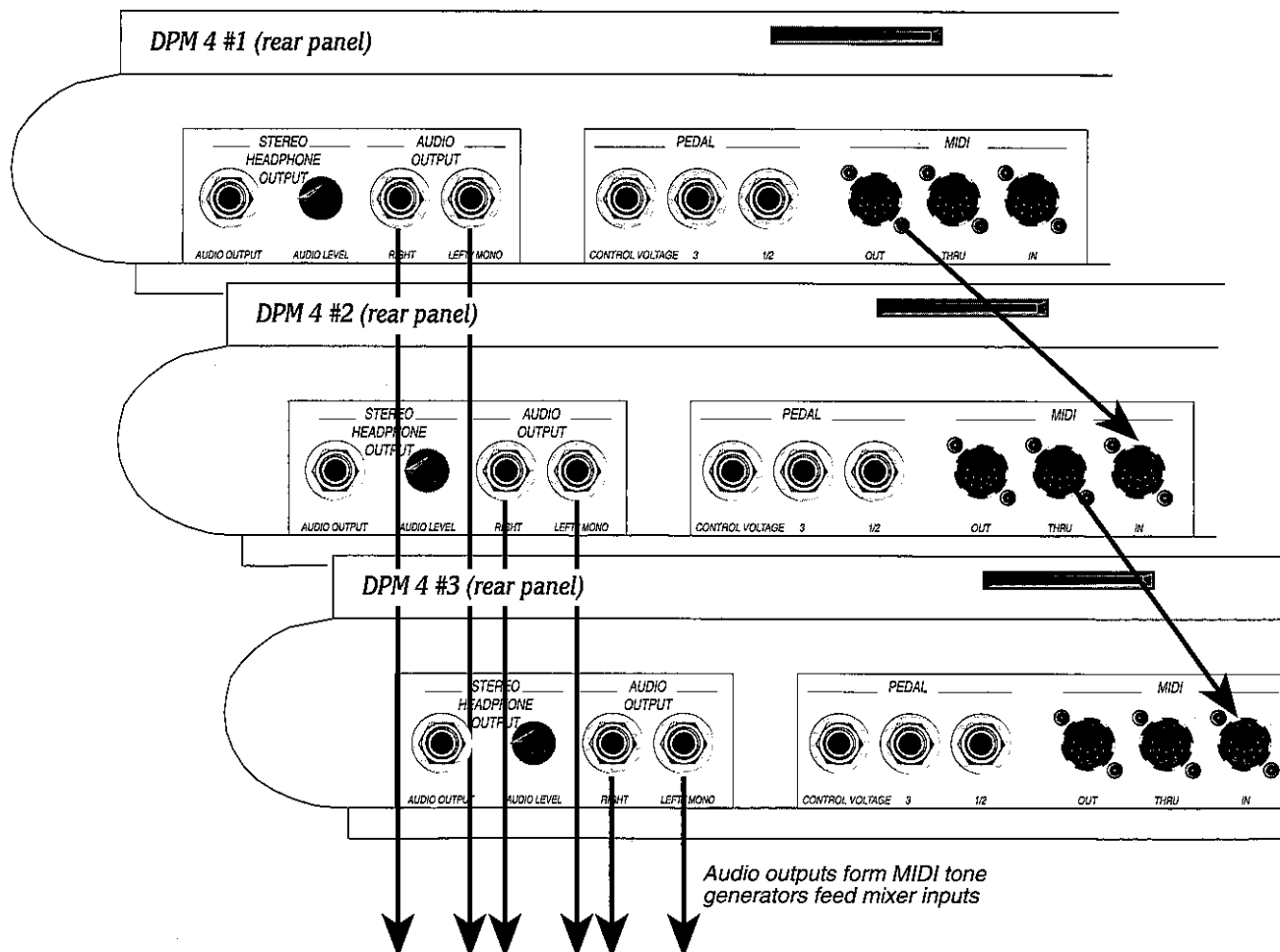

1.1e Studio Use with an External Sequencer

In some studio applications, the DPM will generate master controller signals that are recorded by a sequencer. On playback, the sequencer will send this data back into the DPM, which then serves as a multi-timbral sound module. The sequencer will probably generate data over several channels; the DPM can be programmed so that individual programs play sequenced data from specific channels.

Example: If the sequencer transmits a piano part over channel 1, a bass part over channel 12, and a string pad over channel 14, the DPM could be programmed so that a piano sound plays only the MIDI data assigned to channel 1, a bass sound plays only the MIDI data assigned to channel 12, and a string pad plays only the MIDI data assigned to channel 14. This is called a *Multi* setup; the DPM holds ten such Multis, named Multi01-Multi10.

Audio: The DPM's panning and signal processing options allow you to set up a stereo submix within the DPM, which can serve as the stereo master output or be recorded on tape.

The diagram below shows a typical sequencer-based setup that interfaces with a sequencer and provides mixed stereo outputs.

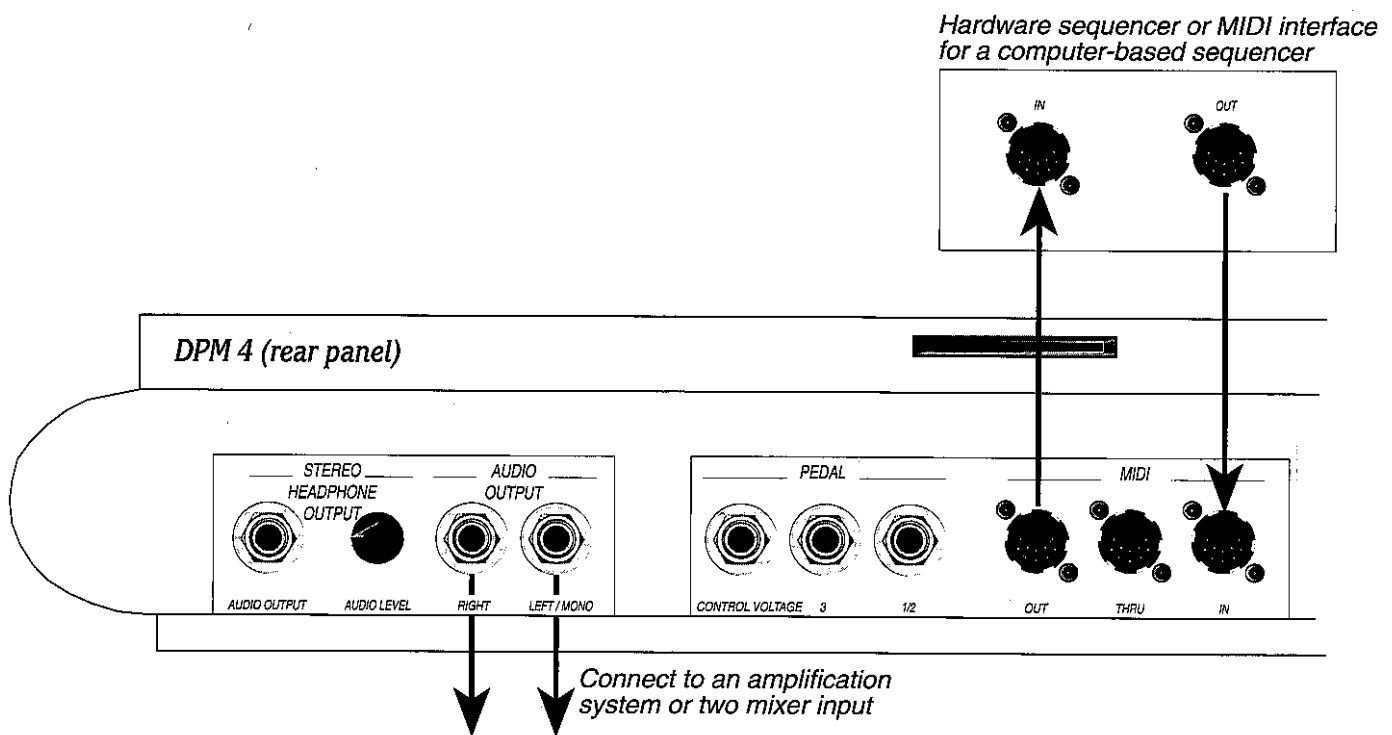

MIDI: If you are driving other MIDI gear such as an expander module or MIDI-responsive signal processor, the usual procedure is to drive these from the sequencer if it has additional MIDI outputs. However, you can also use the DPM MIDI Thru connector to drive other modules, as described in section 1.1d.

1.1f Powering Up

Turn on your equipment in the following order (this is good practice for any MIDI/audio setup, not just the DPM):

- Computer or sequencer (if present)
- Synthesizers, sound generators, and signal processors
- Mixer (with master outputs turned all the way down!)
- Amplification system

Turn up the mixer master output controls to a low level as you test the system. Turn up to normal volume once you're satisfied that the system is working properly.

We'll audition the onboard programs soon, but first let's look at how to communicate with the DPM.

1.2 FRONT PANEL DESCRIPTIONS

There are five main front-panel programming tools.

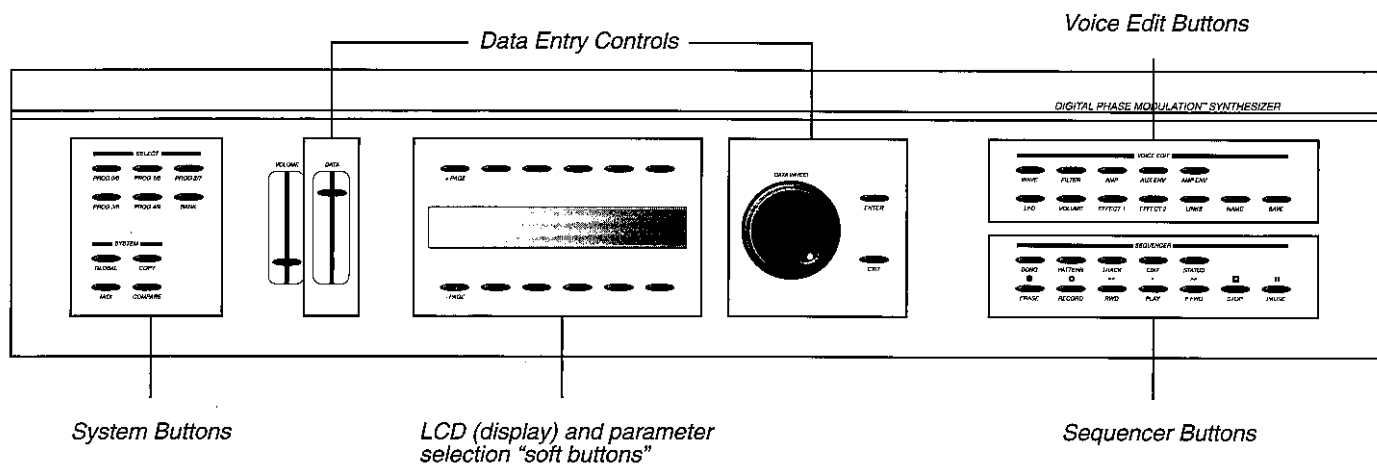

- **System buttons** These select sound programs and various "master" functions, such as mass storage options, MIDI parameters, signal processor editing, sampling parameters, and so on.
- **Voice Edit buttons** When programming sounds, these choose the particular module to be programmed, such as wave, filter, etc.
- **Sequencer buttons** These buttons control all sequencer functions—record, playback, overdub, edit data, and the like.
- **LCD and parameter selection "soft buttons"** The Liquid Crystal Display (LCD, or simply "display") is surrounded by two rows of six "soft" buttons, so called because their functions change depending on what the software wants them to do. Selecting a function with the System, Voice Edit, or Sequencer buttons calls up a particular screen, which identifies the button functions. For example, suppose you select a patch program bank, such as Internal Program Bank 00. The display identifies

the program bank and shows the available programs (the programs in your unit may vary; these are typical):



Each button selects the corresponding program; when you select a program, an asterisk appears to its left.

Examples: Pressing the upper left-hand button selects the program Drmba1. Pressing the third button from the right on the lower row selects AfroVb. Pressing +Page takes you to Internal Bank 01 (the next higher-numbered Bank), and -Page to Internal Bank 09 (the next lower-numbered Bank). There are 10 Banks of 10 programs each.

For convenience, sometimes more than one button can select a function. In the following display:

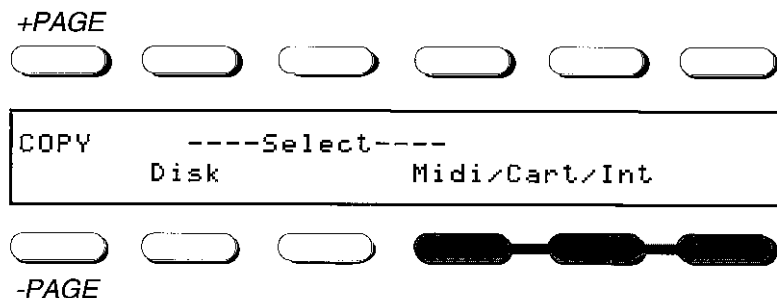

...any of the three buttons under **Midi/Cart/Int** select that option.

Important notes: In this manual, if a button does not select anything on a particular display page, it will be “white” (e.g., the top row of buttons above). If more than one button selects a function, each will be “linked” with a gray strip, as shown under **Midi/Cart/Int**.

About buttons: Another new convention in the DPM is the ability to move from one page of parameters to another by repeatedly pushing a button. *Example:* If you press the **Filter** Voice Edit button, the FILT1 page of parameters is displayed. Pressing the Filter Voice Edit button again displays the FILT2 page of parameters.

Although in most cases the button under both the value to be changed and the parameter name are “active,” thus letting you select a parameter for editing, sometimes this is not possible due to space limitations. In this case, the button directly under the value to be changed is usually the active button.

More about buttons: The button above and below the parameter fields (you know, around the display), act as increment (top row) and decrement (bottom row) buttons. *Example:* If you are attempting to change the displays viewing angle, pressing the button above the View parameter will increase the value and pressing the button below the View parameter will decrease the value.

- **Data entry controls** Parameters to be changed are usually selected via soft buttons on the LCD, but once selected you will often need to enter a particular parameter value (“data”). The DPM offers several methods of data entry which accomplish the same function, but in different ways.

Enter Use this button to confirm or accept changes to parameter values.

Exit Use this button to abort a function.

Data slider Use to scan through a wide range of values with a single motion.

Data wheel (DPM 4) This is often the fastest way to change values. Spin it to cover a wide range of values, then rotate it more slowly to zero in on a particular value.

When we talk about “selecting” a parameter value while programming, it means that you can use any of the data entry devices. A parameter is available for editing if it is flashing or if it is preceded by a flashing = or * symbol.

Important: If you ever want to bail out of an editing operation, hit any button other than a “soft” button.

Other front-panel controls and features are:

- **Volume control** This controls the master volume level for the entire instrument. Individual programs can also have their own individually programmed volumes, controlled proportionately by this master control.
- **Memory cartridge slot (DPM 4)** This is located toward the rear of the front panel. Peavey and other manufacturers offer alternate programs for the DPM, stored in cartridges. Blank cartridges, such as the Peavey Cache Card (part #0071023), are available for saving your own programs to cartridge.
- **Modulation wheels** The left Pitch wheel is dedicated to controlling pitch bend. The right Modulation wheel can be assigned to any of several parameters, such as volume, vibrato depth, timbre, etc..
- **Disk drive** Located just above the wheels, this is the DPM’s main data storage and retrieval device. It allows for storing and loading programs, sequences, samples, signal processor settings, MIDI system exclusive data, etc.

1.3 QUICK PARAMETER SETUP

1.3a Auditioning Programs

Now that all the connections are made and you know how the front-panel controls work, let’s hear what the DPM can do.

1. Set up the DPM.
2. Press one of the **Prog** Select buttons (i.e., *PROG 0/5*). A display appears showing the various patches in that Bank (the following is a typical display; your unit might have different programs).

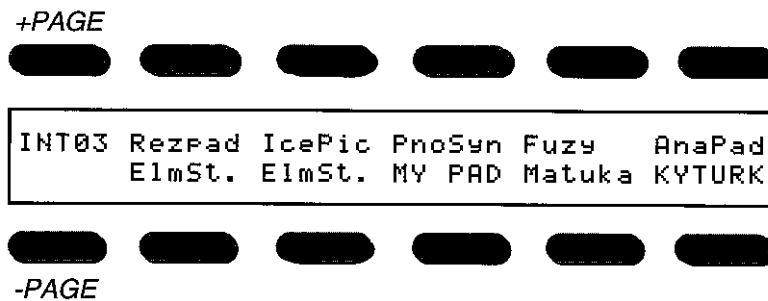

3. To select a particular program, press the associated button above or below the program name. Play away! Check out the modulation wheels and apply pressure to the keyboard after keys are down to see if these physical gestures alter the sound for a given program. If you don't hear any audio:
 - Make sure the output connections are properly hooked up.
 - Check that the amplifier is on and the mixer volume turned up.
 - Make sure the DPM's front-panel volume control is turned up.
4. To select the next higher-numbered Bank of programs, press the *+Page* button. To select the next lower-numbered Bank, press the *-Page* button.
5. An alternate way to select Banks is to "reclick" on a Bank button. Note that the legend for each Bank button shows two numbers, such as 1/6. This indicates that if one of the Bank numbers is selected, clicking on that button will call up the alternate Bank. *Example:* If Bank 3 is selected, relick on the **Prog 3/8** button and Bank 8 will appear. You can also "double-click" to go directly from one Bank to another. *Example:* Suppose Bank 1 is selected and you want to select Bank 9. Press the **Prog 4/9** button twice; on the first press, Bank 4 appears, and on the second press, Bank 9 appears.
6. Selecting cartridge programs is similar. The **Bank** button "toggles" between Cartridge and Internal banks; pressing **Bank** while in Internal memory selects Cartridge memory, and pressing **Bank** while in Cartridge memory selects Internal memory. Cartridge Banks are selected the same way as Internal Bank programs.

1.3b Setting Parameters for Use as a MIDI Keyboard Driving a Second MIDI Module

1. Determine the MIDI channel over which the second module (signal processor, synth, etc.) receives data. If you do not know, assume it's not channel 1.
2. Press the DPM's **MIDI** system button. The following display appears:

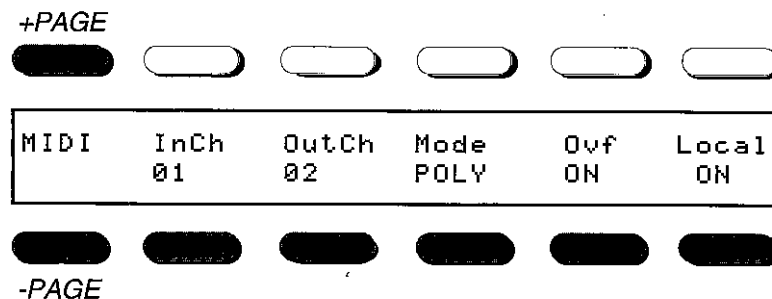

3. Press the **OutCh** soft button to change the MIDI channel to something other than 01. The current channel number will flash, indicating the parameter is selected for editing. Use any of the data entry devices to select the desired MIDI channel. The DPM will transmit data over this channel to the expander module. If playing on the DPM does not trigger the expander module, check your

MIDI cables and try different channels; perhaps the expander module is set to a channel other than the one you selected.

1.3c Multi Mode: Setting Parameters for Studio Use with a Sequencer

In this situation you will probably want to set up for multi-timbral operation. There are ten independent multi-timbral setups, Multi01-10. Each “instrument” in a Multi must be set up individually.

1. Press the **MIDI** System button; then press the *+Page* soft button until you see the following page:

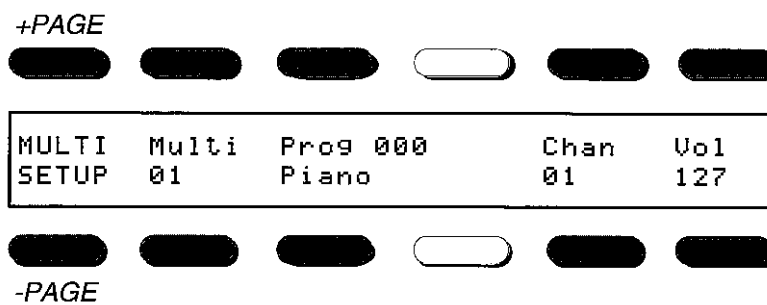

2. Select from Multi01 through Multi10 by either the soft button above or below the word **Multi**.
3. The display shows the Multi number, program assignment, MIDI channel, and volume of the selected Multi.
4. Determine the MIDI channels to which you want to assign DPM programs. The DPM will play back up to sixteen channels simultaneously. If needed, the same program can be assigned to more than one channel. *Caution:* The DPM cannot play more than 32 voices at a time. Therefore, assigning multiple programs to multiple channels increases the odds that newly played notes will “steal” older notes that are still sounding. See section 1.4 for more information about how the DPM reacts when asked to play more than 32 voices at a time.
5. Press the soft buttons over *Prog* and select the desired program with any data entry device. This is the program that will be played by sequencer data appearing over the channel selected (in our example channel 01 is selected).
6. Similarly choose program assignments for MIDI channels 02-16, if desired.

As you become more familiar with the DPM, you’ll probably want to program setups for Multis 02-10, as well. Multis are also useful for guitar synthesists, who often set up a separate sound for each individual string.

Caution: Remember that no matter how many programs you assign, the DPM cannot play more than 32 voices at a time.

1.4 ABOUT DYNAMIC ALLOCATION

The DPM can play up to 32 voices at a time. However, each voice can consist of two oscillators making different sounds or tuned to different pitches, allowing 32 keys to play up to 32 notes simultaneously.

If 32 voices are playing (or sustaining) and you play a new key, this will “steal” the least useful voice that is still playing—for example, one that has almost reached the end of its decay. This intelligent voice selection process is a considerable improvement over synthesizers that merely steal voices on a “first-played, first-to-be-stolen” basis.

Chapter 2: The Most Common DPM Operations

The DPM is a very “deep” instrument with lots of options, so to help make the learning curve a little easier, some of the most important operations—saving and loading data, communicating with other MIDI gear, and editing crucial sound parameters—have been collected in this chapter.

Important: As you experiment, remember that any changes made to the factory patches shipped with the unit will, if you save those changes, be remembered by the DPM. You can recall the factory patches at any time by loading in the Setup disk that came with the DPM keyboard.

2.1 TUNING, KEYBOARD RESPONSE, AND VIEWING ANGLE EDITS

2.1a Global Tuning

This tunes the DPM to other instruments or concert pitches other than A=440.

1. Press the **Global** System button.
2. Press the *-Tune-* soft button. The display shows:

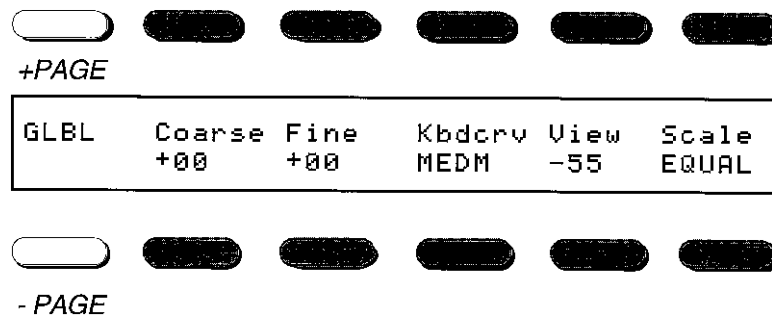

3. To adjust the master tuning in semitones press the *Coarse* soft button (adjusts the master tuning in ± 12 semitone steps) and select the desired value. Think of coarse tuning as a “global transposition” option that can offset middle C up to ± 1 octave.
4. To adjust the master tuning in cents (1/100th of a semitone) press the *Fine* soft button (adjusts between ± 99 cents) and select the desired value.

The scale and user tuning functions are described in section 8.2.

2.1b Keyboard Velocity Response

Different players play their keyboards with different degrees of force. This function matches the DPM to your playing style.

1. Press the **Global** System button.
2. Press the *-Tune-* soft button. The display shows:

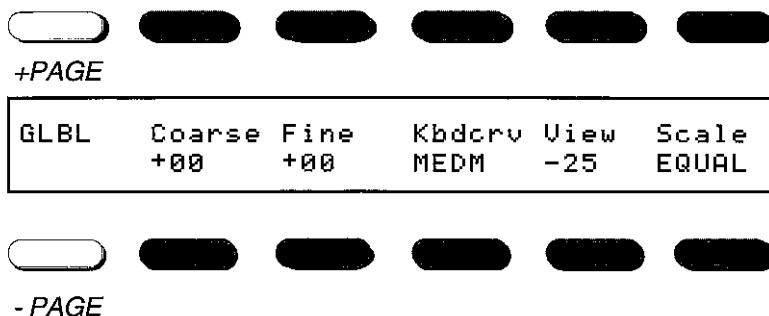

3. Press the *Kbdcrv* soft button and select the desired keyboard action: SOFT (light playing gives the full velocity range), MEDM (standard velocity response), or FIRM (requires a heavy touch to give the full velocity range).

2.1c Display Viewing Angle

The display is easier to read at some angles than at others. This adjusts the display for the best contrast for your particular viewing angle.

1. Press the **Global** System button.
2. Press the *-Tune-* soft button.
3. Press the *View* soft button and set the viewing angle from +00 (brighter) to -75 (darker).

2.2 MAIN MIDI EDITS

All MIDI edits are remembered *except* for the Local Control setting, which always reverts to ON after power-up.

All MIDI edits start by pressing the **MIDI** System button. The display shows:

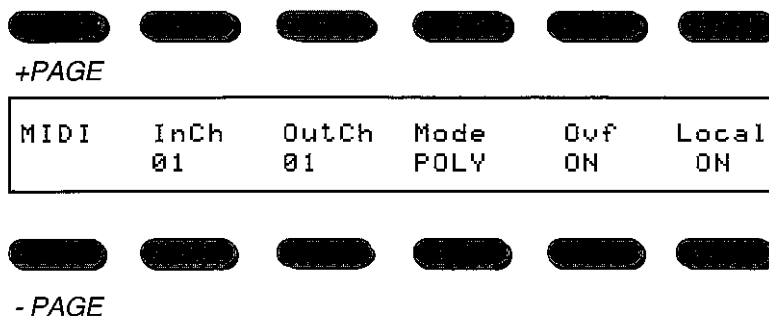

2.2a Change MIDI Input Channel

This sets the DPM's *base channel*, the channel over which data is received in Poly mode and over which program changes are received in any mode. The input channel can be set independently of the output channel.

In Omni mode, the DPM plays all 16 MIDI channels back through whatever patch program you've selected; in Multi mode, channel and program assignments are set under the Multi menu, described in section 1.3c.

1. Press the *InCb* soft button.
2. Select a MIDI channel between 1 and 16.

2.2b Change MIDI Output Channel

This sets the base channel over which data is transmitted (however, it is possible in Combi mode to transmit over several channels simultaneously; see section 4.3h4). The output channel can be set independently of the input channel.

1. Press the *OutCb* soft button.
2. Select a MIDI channel between 1 and 16.

2.2c Change MIDI Mode

The DPM can choose between Omni, Poly, and Multi (multitimbral) modes.

1. Press the *Mode* soft button.
2. Select the desired MIDI mode. Note that there are ten individual Multi modes (Multi01- Multi10), each of which stores the settings for a particular Multi setup (section 1.3c).

2.2d Enable Overflow Mode

Overflow chains DPM's together to increase the number of voices available. Chaining two DPM's together gives you 64 voices, chaining three together would give you 96 voices.

If the first DPM in the chain runs out of voices, it assigns any "overflow" notes to the next DPM in the chain rather than steal its own voices.

To enable overflow mode:

1. Load the same programs into all the DPMs being used and run their outputs into a mixer. Make sure all DPMs are in Poly mode and tuned to the same MIDI channel.
2. Connect the first DPM's MIDI Out to the second DPM's MIDI In.
3. If using a third DPM, connect the second DPM's MIDI Out (not MIDI Thru!) to the third DPM's MIDI In.
4. Press the *Ovf* soft button and select ON for all DPMs except the last one in the chain.

2.2e Turn Local Control On or Off

With Local= ON, the DPM keyboard plays the internal sounds and sends data out over MIDI. With Local= OFF, the DPM keyboard sends data out over MIDI but does not play the internal sounds.

When used as a master keyboard in conjunction with a sequencer program, the sequencer will often include a “software MIDI Thru” feature that rechannels incoming MIDI data from the DPM and sends it out over any channel you want. In this situation, Local Control should usually be off.

1. Press the **MIDI** System button.
2. Press the *Local* soft button.
3. Select ON or OFF.

2.2f Filter Out MIDI Data

When using the DPM as a master keyboard, you may want to suppress certain types of data from being transmitted; when playing back from a sequencer, you may want the DPM to ignore certain types of data. This option allows for both.

1. Press the **MIDI** System button. Use the *+Page* and *-Page* buttons to get to the following two displays:

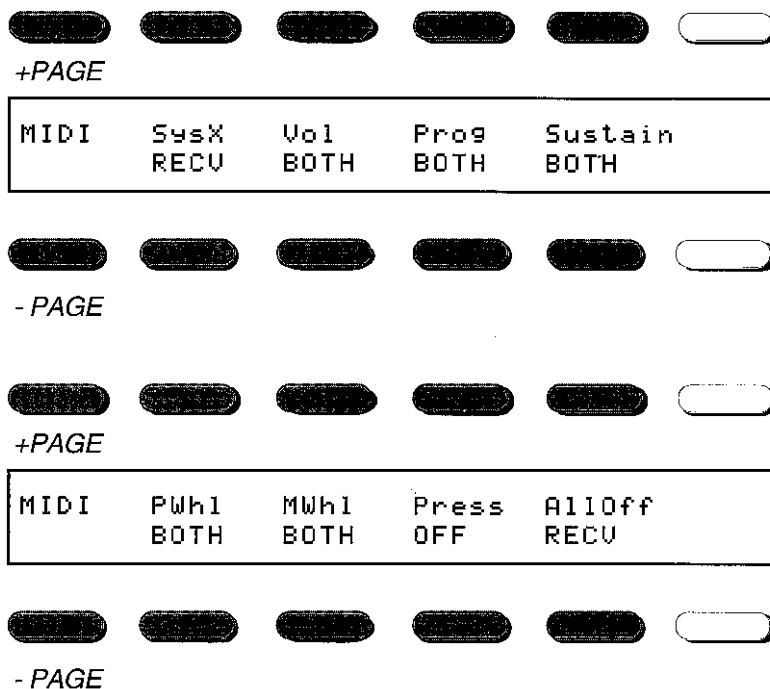

2. Select the MIDI data to be filtered by pressing the corresponding soft button:

- **SysX** System Exclusive data
- **Vol** Volume
- **Prog** Program changes
- **Sustain** Sustain pedal data

- **PWhl** Pitch wheel
- **MWhl** Mod wheel

- **Press** Pressure (also called aftertouch)
- **Alloff** This turns all filters Off.

3. Enter the desired filter status:

- **Off** The associated data is neither received nor transmitted.
- **Xmit** The associated data is sent from the DPM, but incoming data of the specified type is ignored.
- **Recv** The associated data is received by the DPM, but not transmitted.
- **Both** The associated data is both received and transmitted by the DPM.

4. To return to the main MIDI screen, press the *+Page* or *-Page* buttons.

Caution: When driving the DPM from a different keyboard, note that some master keyboards assign the footpedal to controller 7, reasoning that it will be used as a volume pedal. If you have problems ignoring pedal information, this might be why.

2.3 STORAGE FUNCTIONS

2.3a Cartridge Memory Management

The DPM's internal memory can be transferred to a cartridge as a block, and cartridge data can be transferred to the internal memory as a block. *All cartridge references apply to the DPM 4 only.*

1. Press the **Copy System** button.

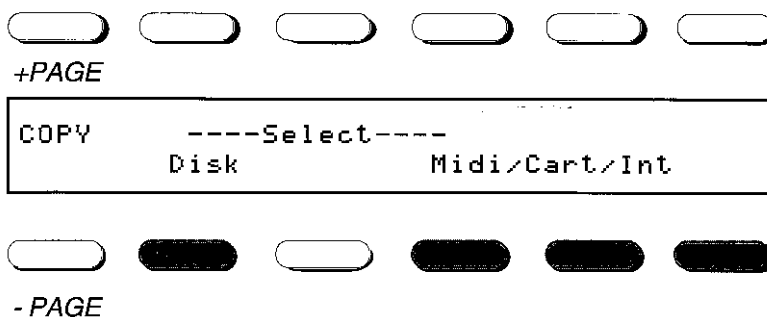

2. Press the *Midi/Cart/Int* soft button. The display shows:

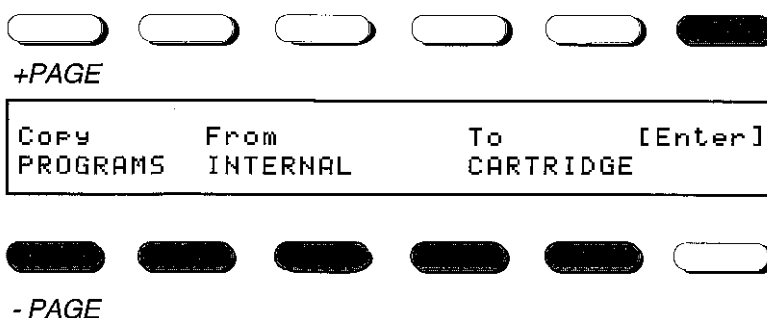

3. Press the *From* soft button and select INTERNAL.
4. Press the *To* soft button and select CARTRIDGE.
5. Press the **Enter** button.

If you attempt to write to a memory-protected cartridge, after pressing **[ENTER]** soft button, the display shows:

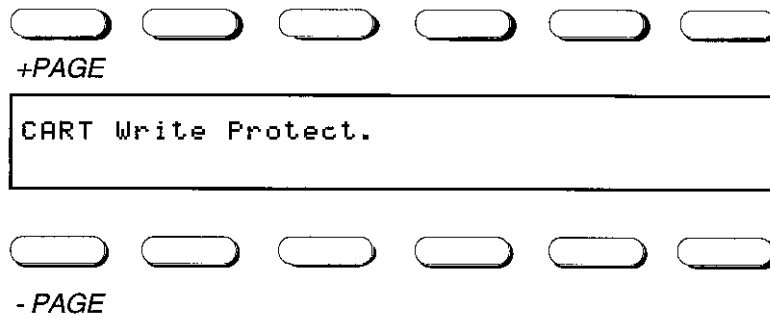

Disable write protection by changing the position of the cartridge's write protect switch, and try again.

2.3b Format a Disk Prior to Saving Data

Although the DPM's memory is nonvolatile (i.e., is battery-backed up to prevent loss of data while the unit is turned off), accidents can happen, from a battery going bad to operator error (Ooops! Didn't mean to load the cartridge data into internal memory after all...). As a result, it's vital to save your data periodically.

You may also become sufficiently seduced by the DPM's programming options to make up sets of your own sounds. These should also be saved.

Although cartridges are a convenient storage medium, they are mostly used to extend the number of programs available at one time. It is much less expensive to store data to disk. However, a blank disk must first be *formatted* to accept DPM data. Also, note that disks must be handled with care. If you are not familiar with how to handle disks, see section 9.7.

To format a disk:

1. Press the **Copy** System button.
2. Press the *Disk* soft button. The display shows:

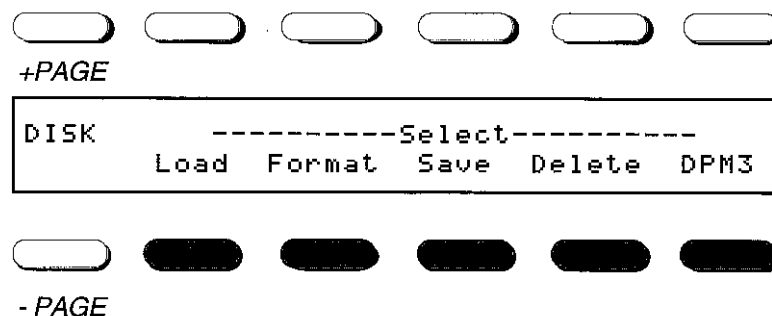

3. Press *Format*. The display shows:

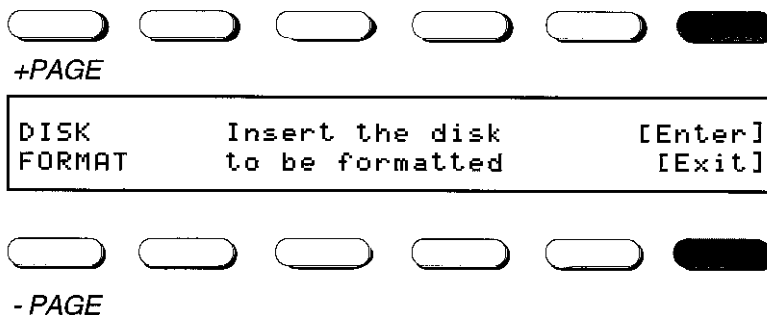

4. Insert the disk into the disk drive (if you're not familiar with disk insertion procedures, see section 9.7) and press the **[ENTER]** soft button. If you change your mind about formatting, press **[EXIT]**.
5. The DPM will examine the disk. If it is not empty, the display will alert you and let you either continue (which erases everything on the disk) or exit to cancel formatting.
6. While the disk is formatting, the display will show which track and side of the disk are being formatted.

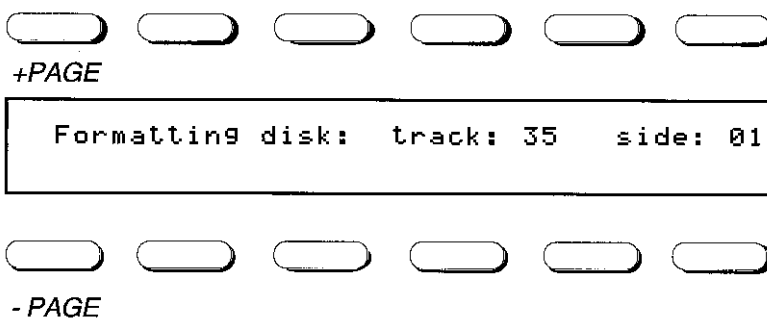

7. When the DPM reaches track 79, side 01, the format is complete. The display shows:

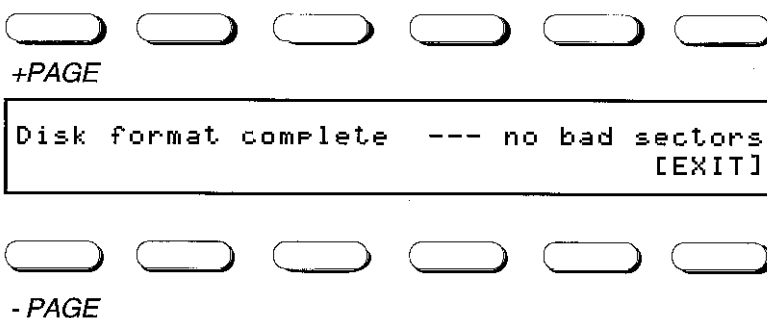

The disk is now ready to store DPM data. Press **[EXIT]** to leave the disk formatting function. If the disk is damaged or there is some other formatting problem, the display will indicate the number of bad sectors.

2.3c Saving Data to Disk and Naming Data Files

You can save a variety of data to disk. Each data file can be saved under its own name.

Important: When saving individual pieces of data (single sequence, single program), the desired sequence or program must be selected prior to saving.

1. Press the **Copy** System button.
2. Press the *Disk* soft button.
3. Press the *Save* soft button. The display shows the type of data you can save:

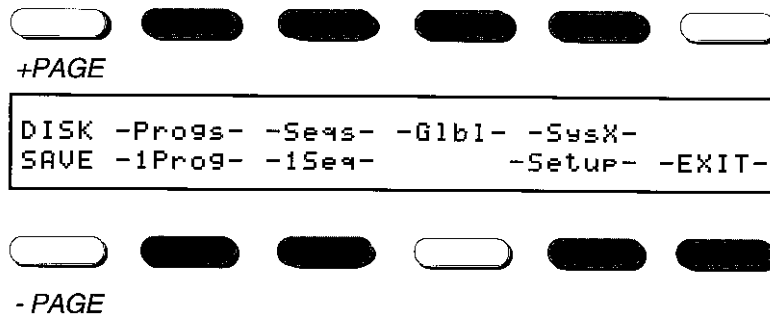

- **Progs** Saves all 100 programs in internal memory as a group.
- **Seqs** Saves all 50 sequences and 10 songs in internal memory as a group.
- **Glbl** Saves all Global data (MIDI and master menu settings).
- **SysEx** Saves any MIDI system exclusive data in memory (see section 8.3).
- **1Prog** Saves one program.
- **1Seq** Saves one sequence.
- **Setup** Saves all programs, sequences, and effects patches. Most beginners may want to just save a Setup, as it saves a “snapshot” of all DPM parameters including Global data.

4. After selecting the data type to be saved, the display lets you name the data. The following shows the display when saving all programs, but the other functions use a similar screen.

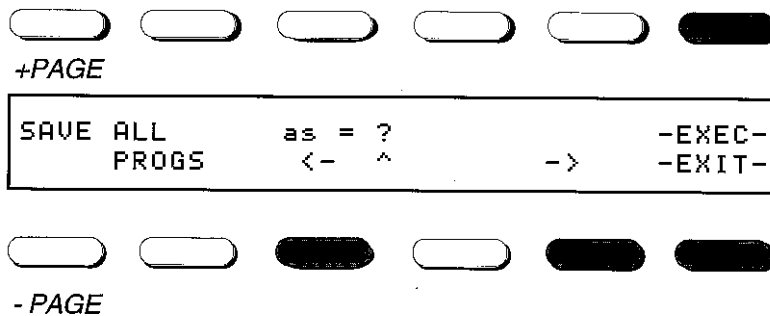

5. A small circumflex (^) symbol shows up underneath the character that will be edited with the data entry devices. Select the desired letter, number, or symbol. To move the circumflex under a different character, use the left arrow or right arrow cursor buttons to move left or right respectively.
6. After naming the data to be saved, press the **-EXEC-** soft button. (If you change your mind about saving, press the **-EXIT-** soft button.) The disk drive will whir into action, and the display will indicate data is being first saved, then verified to insure data integrity. Press **-EXIT-** when you’re done, or select a different function.

Note: Due to MS-DOS limitations only the following characters are available for naming a disk file (in order of appearance):

space A-Z 0-9 &) (# - ` ' \$ % @ { } → ^

2.3d Loading Files from Disk

You can load a variety of data from disk. Each data file can be loaded by name.

Important: When loading a single program or a single sequence, this data is stored in a temporary memory buffer for auditioning. To retain this data, it must then be saved to the desired program or sequence memory location, as described later in this section.

1. Press the **Copy** System button.
2. Press the *Disk* soft button.
3. Press the *Load* soft button. The display shows the type of data you can load:

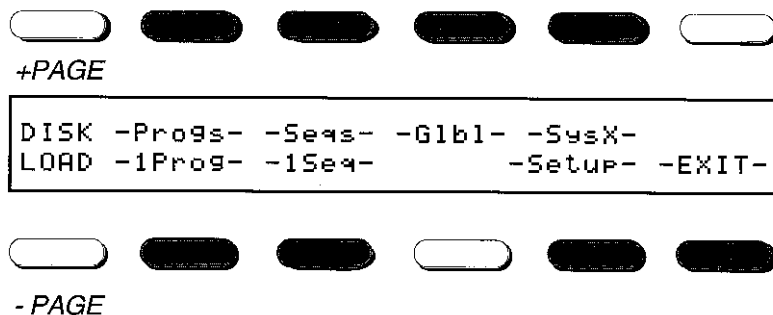

- **Progs** Loads a group of 100 programs from disk.
- **Seqs** Loads a group of 50 sequences and 10 songs from disk.
- **Glbl** Loads a Global data file (MIDI and master menu settings).
- **SysEx** Loads a MIDI system exclusive data file (see section 8.3).
- **1Prog** Loads a single program.
- **1Seq** Loads a single sequence.
- **Setup** Loads a “snapshot” of all DPM parameters—programs, sequences, and effects patches.

4. After selecting the data type to be loaded, the DPM searches the disk for the specified file type. If such files are present, the display shows something like:

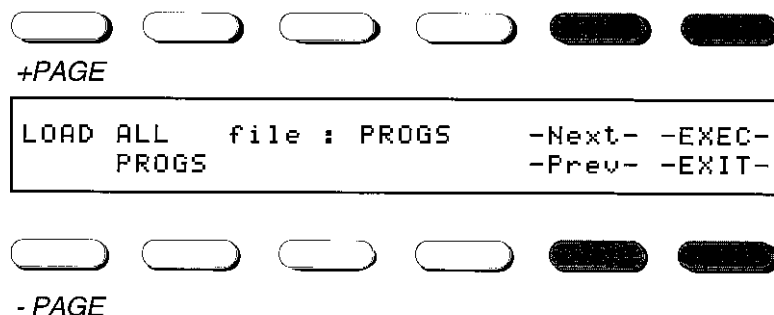

5. In this example, the DPM was asked for all program files; it has searched the disk and displayed the first program file it found. Pressing **-Next-** selects the next program file. Keep pressing **-Next-** to catalog additional files of the same type. Pressing **-Prev-** selects the previous program file.
6. After selecting the data to be loaded, press the **-EXEC-** soft button. (If you change your mind about loading, press the **-EXIT-** soft button.) The disk drive will whirl into action, and the display will indicate that it is loading data from disk. Press **-EXIT-** when you're done, or select a different function.

Note: If you load a program based on a drum kit wave, the display will ask whether you want to replace the current drum kit with the kit used by the program. Press the **-YES-** soft button, and the program with its drum kit parameters will be loaded. Press **-NO-** and the program will be loaded, but without replacing the current drum kit. A final option, **-EXIT-**, lets you back out of the loading process.

7. If you loaded an individual program or sequence, do the following:

- **Program** See section 2.4a on how to save the buffer memory to a program location.
- **Sequence** Press the **Pattern** Sequencer button. The display shows a Bank of sequence locations; you can change Banks with the *+Page* and *-Page* buttons. Press the soft button corresponding to the location where you want to store the sequence or song. When the display shows “Save Last Sequence Edits?” press **-YES-**. You will be given a chance to rename the sequence before pressing **-EXEC-**. Press the soft button again that corresponds to the location where you want to store the sequence or song, and storage is complete.

2.3e Deleting Files from Disk

Any file type can be deleted from disk if the file is no longer needed, or if you want to free up additional disk space.

1. Press the **Copy** System button.
2. Press the *Disk* soft button. When the Disk menu appears, press the *Delete* soft button. The display shows:

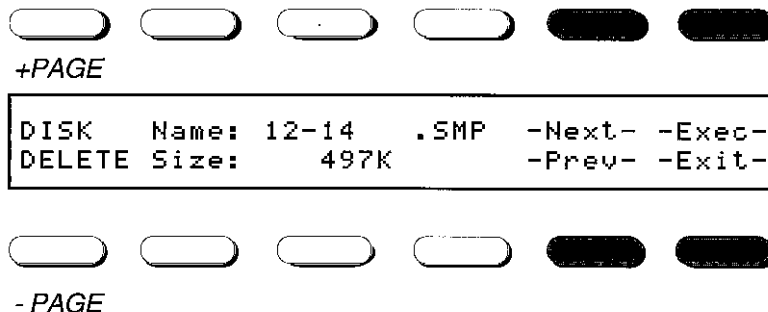

To scroll through the file directory, press the **-Next-** or **-Prev-** buttons. Each file will have an identifying three-letter extension:

- .PRO All programs
- .SQN All sequences
- .1PG Single program
- .1SQ Single sequence
- .SMP Sample wave
- .SUP Setup file
- .GBL Global parameters
- .SYS System exclusive data

The size of each file is also shown in Kilobytes to help you determine which files should be deleted to free up a desired amount of disk storage space.

3. After selecting the file to be deleted, press the **-EXEC-** soft button to delete the file. If you change your mind, press **-EXIT-**, or select a different function.

2.3f Sending Data via MIDI System Exclusive Messages

In addition to disk saves and loads, many DPM data files can be sent over MIDI. These appear over the DPM's MIDI Out port as MIDI system exclusive (sys ex) messages. This feature has three main applications:

- Send the data to a MIDI system exclusive storage device (such as the Peavey MIDI Streamer™). This data can then be played back into the DPM to reload whatever data you saved. This provides another form of backup that could prove very useful if the disk drive should fail.
- Record MIDI system exclusive data into a sequencer. On playback, the sequencer can automatically send out new patches to the DPM. *Caution:* Most sequencers cannot cope with long system exclusive files. In most cases, this should be limited to single programs and fx.
- Transfer data from one DPM to another. To do this, connect the source DPM MIDI Out to the destination DPM MIDI In. As soon as the destination instrument recognizes a system exclusive message, it will grab that data and stuff it in memory.

Note: When sending individual pieces of data (single program or single sequence) over MIDI, the desired program or sequence parameters must be selected prior to sending.

The DPM can also serve as a system exclusive storage device for other devices in a MIDI system. *Example:* You can store your drum machine system exclusive data on a DPM disk instead of saving to something like a cassette interface. This is an entirely different function compared to sending and receiving DPM data over MIDI; system exclusive storage is covered in section 8.3.

1. Press the **Copy System** button.
 2. Press the *Midi/Cart/Int* soft button. Press the soft button under *To* and change to MIDI.
- The display shows:

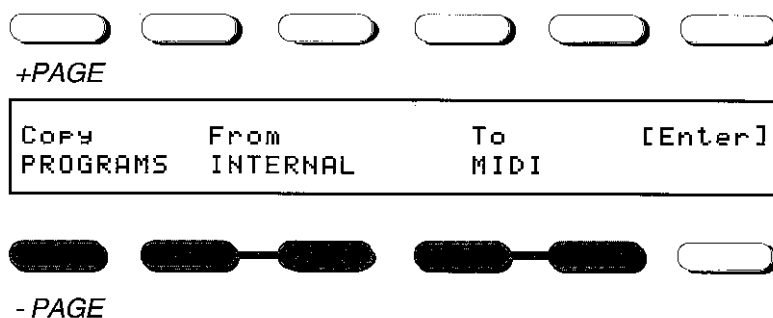

3. Press the soft button under *Copy* to select one of the following:

- **Programs** Sends all program data.
- **Drum Kits** Sends all drum kit data.
- **Glbl Data** Sends all Global data (MIDI and Global menu settings).
- **All Data** Sends all data.
- **Waves** Sends all wave or individual wave data.
- **Filters** Sends all filter or individual filter data.
- **Envelope1** Sends all envelope 1 or individual envelope 1 data.

- **Envelope2** Sends all envelope 2 or individual envelope 2 data.
- **Envelope3** Sends all envelope 3 or individual envelope 3 data.
- **Envelope4** Sends all envelope 4 or individual envelope 4 data.
- **LFO** Sends all LFO or individual LFO data.
- **Combi** Sends all combi or individual combi data.
- **Effects** Sends all effects or individual effects data.
- **Kit** Sends all kit or individual kit data.
- **Initialize Cartridge** Allows you to initialize a cartridge. (DPM 4)

4. Press the **Enter** button to complete the function.

2.4 EDIT MENU TWEAKS

The Voice Edit buttons call up screens that contain a wealth of commands for modifying the DPM's sounds, or creating your own from scratch. Chapter 4 describes these options and provides information on basic synthesis techniques (also see Chapters 9 and 10 for more information on synthesis and MIDI), but here are some of the most common tweaks.

Important: Any changes you make must be saved to the current program or a different one. Selecting a different program without saving the program you modified will cancel any edits you made. Therefore, we will first describe how to save an edited program.

2.4a Save/Rename an Edited Program

1. After modifying the program or loading a single program, press the **Save** Voice Edit button.

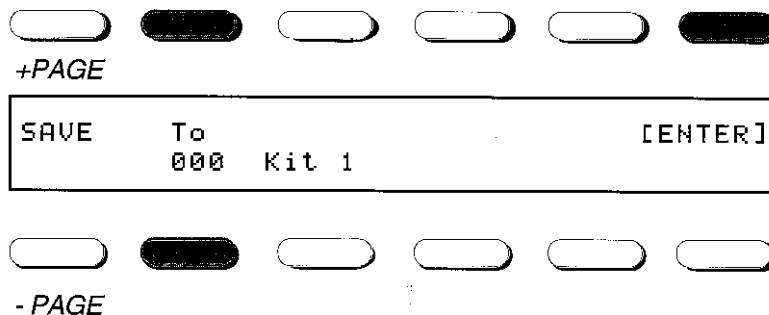

2. To save the edited program to the same location press the **[ENTER]** button.
3. To save the edited program to a new location press the soft button above the program number and use either the soft buttons, data wheel (DPM 4), or data slider to select the new location.
4. You can rename the program before storing by first pressing the **Name** Voice Edit button.

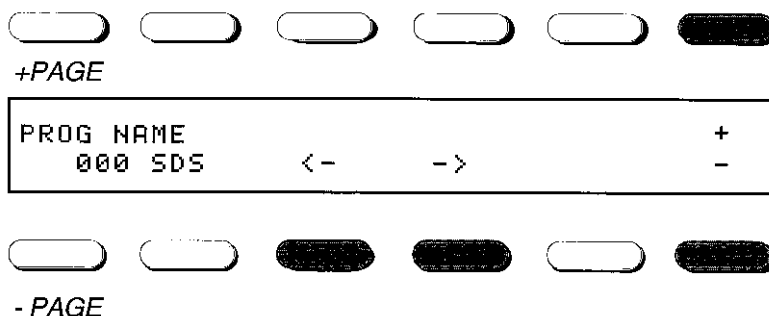

5. Press the button above either the <- or -> arrow to move to from character to character. Use the data slider or data wheel (DPM 4) to change the character.
6. After you finish renaming your program press the **Enter** button. To abort press the **Exit** button. The main program display will show a *E* in the lower left corner of the display to indicate that the selected program has been edited.

Note: The following characters are available for naming your saved file (in order of appearance):

space A-Z a-z 0-9 + - =) (* & ^ % \$
@ ! → ` { } [] | ' : ; ? / , .

2.4b Change Overall Timbre (“Brighter/Duller”)

Although there are many ways to change timbre in the DPM, the following method is fast and takes care of many situations where you want to modify timbre.

1. Press the **Filter** Voice Edit button. The display shows something like:

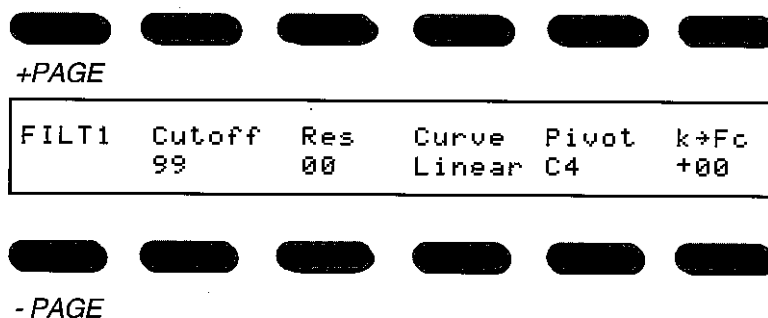

2. Press the *Cutoff* soft button, and increase the value (this makes the overall timbre “brighter”).

2.4c Increase/Decrease Timbre “Dynamics”

Sometimes the timbre responds dynamically over time, perhaps according to keyboard velocity or to the DPM’s internal envelope generators. The DPM offers two different *modulators* (modules that create control signals that change dynamics over time) for the filter, as shown on the lower Filter screen line. The following process involves editing one, the other, or both to create the desired effect.

1. The Filter screen “MODS” page (go to the Filter page, either filter 1 or filter 2, and press the +Page button) allows you to modulate the filter with one of the following:

- VELO - This is velocity
- KEYBD - Keyboard
- PRESS - Pressure
- ENV1-4 - Envelopes 1 through 4
- LFO1-2 - LFOs 1 and 2 (Low Frequency Oscillator)
- MWHL - Modulation wheel
- PEDAL - Modulation pedal
- CTRLA-C - Controller A through C.
- PWHL - Pitch bend wheel
- OFF - Of course you can also turn the modulator off.

- Choose the modulation source you want by pressing the buttons above or below **Mod1** (or **Mod2**), using the data slider or using the data wheel (DPM 4).
- After selecting the modulation source you need to set the modulation value. The **Scale** parameter adjusts the modulation value from +99 to -99. The further this value is from 0, either positive or negative, the wider the range of timbre variations; values closer to 0 give a narrower range of timbre variations.
- Repeat steps 2 and 3 for the second modulation source (Mod2).

Note: If only one modulator is active, this is a fairly simple edit. If both modulators are used, the edit becomes more complex, since these two settings may interact.

2.4d Change Program Volume Level

This changes a program's level relative to the other programs.

- Press the **Volume** Voice Edit button. The display shows something like:

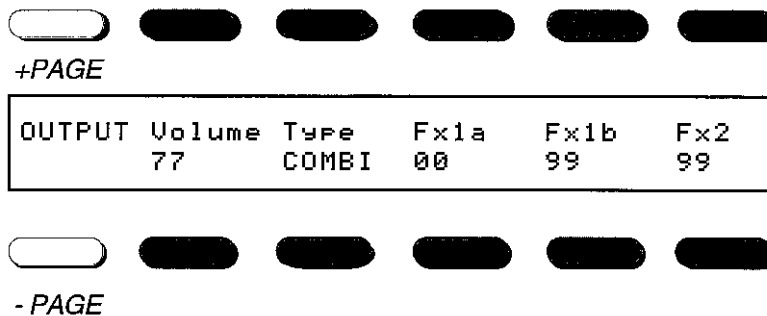

- Press the *Volume* soft button and select the desired volume.

In some cases, turning this volume parameter down will not turn down some of the volume routed to the signal processing section. To turn down the processed level:

- Press the **AMP** Voice Edit button. The display shows something like:

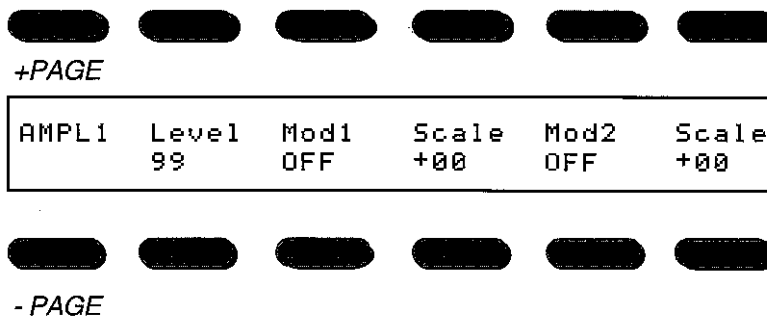

- Press the *+Page* button until you reach the page that has the *Fx2snd* soft button on it and reduce the send level.

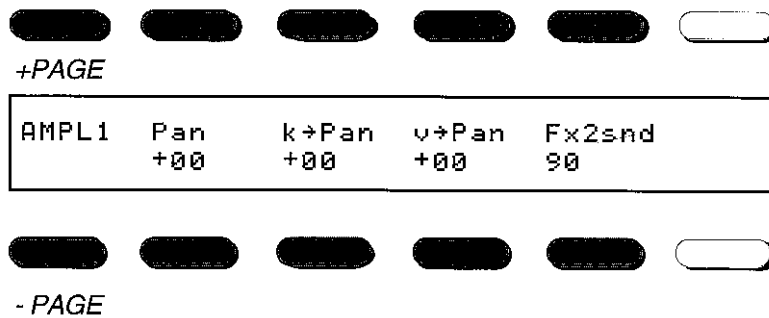

2.4e Change Stereo Pan

This changes a program's position in the stereo field.

Note: Like the filter, the pan position can be modulated by two different modulators. If the pan position is being modulated, then that will also affect the stereo position as well as any changes you make to the Pan parameter.

1. Press the **Amp** Voice Edit button. Press the *+Page* button until you see a display similar to:

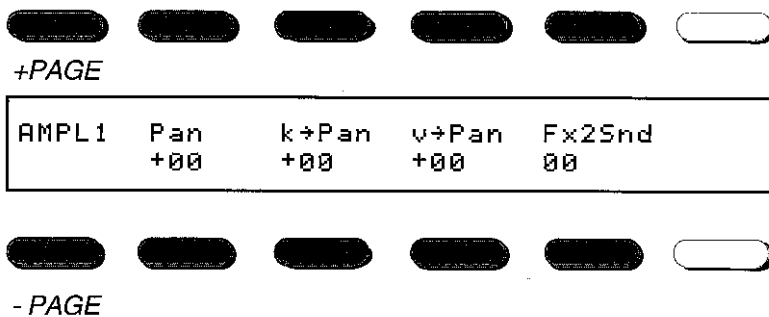

2. Press the *Pan* soft button.
3. Select the desired pan position. 0 is center; more negative numbers pan left (up to -99, full left) and more positive numbers pan right (up to +99, full right).

2.4f Set Pitch Bend Range

This determines how much the pitch of a program will vary in response to either upward or downward travel of the pitch bend wheel. *Example:* If set to a whole tone, rotating the pitch bend wheel all the way away from you will raise the pitch by a whole tone, and rotating the pitch bend wheel all the way toward you will lower the pitch by a whole tone.

1. Press the **Wave** Voice Edit button.
2. Press the *Bend* soft button.
3. Select the desired bend amount—off, half, whole, m3rd (minor third), third (major third), 4th, dm5th (diminished or flatted fifth), fifth, m6th (minor sixth), sixth, m7th (minor seventh), 7th, octave, 2oct (2 octaves).

2.5 ASSIGN FOOTPEDAL AND FOOTSWITCH

The footpedal (if one connects to the footpedal jack) and footswitches can perform several functions and/or transmit particular types of MIDI data over the MIDI Out connector.

The Control Voltage jack accepts a synthesizer control pedal. The 1/2 jack accepts a dual momentary footswitch unit, and the 3 jack accepts a single momentary footswitch unit.

The footswitches plugged into the 1/2 jack are called footswitches 1 and 2; the one plugged into the 3 jack is called footswitch 3. Footswitches can be normally open or normally closed types, as the DPM can be programmed to accept either type.

1. Press the **Global** System button.
2. Press the *-Ctrls-* soft button. The display shows something like:

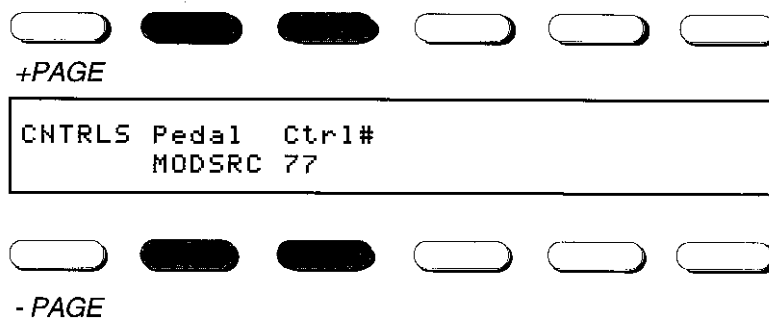

3. The footpedal can be assigned to:

- **Volume** The pedal serves as a volume pedal, and also generates controller 7 data over the DPM MIDI Out connector
- **XCrtl** The pedal generates controller data over the controller number specified under Id
- **ModSrc** The pedal can modulate module parameters (e.g., filter frequency, pan position, oscillator pitch, etc.) if you select Pedal as the module modulator. For more information on modulation, see section 4.2.

To assign, press the *Pedal* soft button and select the desired pedal function and select the desired controller number to be transmitted by the pedal.

5. To assign footswitch parameters, press the *-FtSw-* soft button on the **Global** menu. The display shows something like:

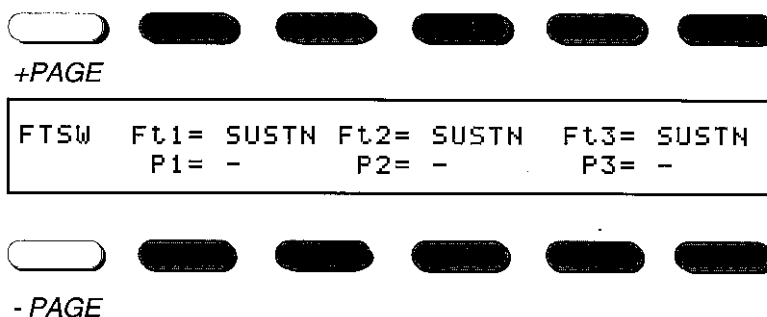

Each footswitch can be assigned to one of the following functions:

- **Off** Footswitch has no effect.
- **Sustn** Footswitch acts as a sustain switch.
- **+Edit** Pressing the footswitch increments the parameter being edited to the next higher value.
- **-Edit** Pressing the footswitch decrements the parameter being edited to the next lower value.
- **+Prog** Pressing the footswitch calls up the next higher-numbered program than the one currently selected.
- **-Prog** Pressing the footswitch calls up the next lower-numbered program than the one currently selected.
- **Play** Footswitch duplicates the sequencer Play (>) button.
- **Recrd** Footswitch duplicates the sequencer Record (O) button.
- **Pause** Footswitch duplicates the sequencer Pause (||) button.

To assign, press the *Ft1*, *Ft2* or *Ft3* soft button and select the desired function.

If the “polarity” of the footswitch is reversed (e.g., releasing a footswitch initiates a function but you’d rather initiate the function by pressing on the footswitch), set the footswitch’s associated P (polarity) parameter to the opposite of the current selection (e.g., + instead of -, or - instead of +). This also allows you to use normally open or normally closed footswitches, and simply program the P parameter as needed to give the correct footswitch response.

2.6 MASTER EFFECTS SELECTION

Global effects selection determines how the DPM will choose a particular signal processing (effects) program. Options are:

- **Program** Selecting a program calls up the effects parameters associated with that program.
- **Master** Retains an effect you specify, regardless of what program or sequence is selected.
- **Sequence** Each sequence has an associated effect. With this option, calling up a particular sequence will call up its associated effect.
- **Auto** If you select a program, its effects parameters will be used. If you select a sequence, its effects parameters will be used.
- **Bypass** No effects are used.

To select one of the above options:

1. Press the **Global** System button.
2. When the Effect menu appears, press the *-FxSelect-* soft button. The display shows:

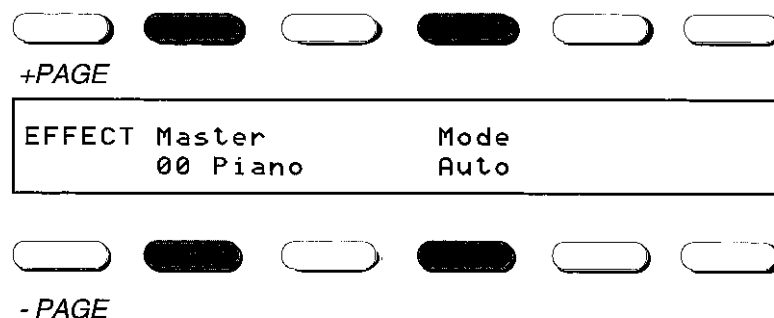

3. To specify the mode (Program, Master, Sequence, Auto, or Bypass), press the *Master* soft button and select the desired option.

2.7 INITIALIZE ENTIRE UNIT

This operation restores the original factory global and MIDI settings, erases any samples stored in user RAM (if present), restores *all* programs to a default patch (not the factory patches shipped with the unit), and *erases any edits you have made*. Initialization is useful if, for example, you want to create a set of sounds from scratch.

Initialization is also a service procedure. Sometimes microprocessor-controlled devices will “lock up” due to spikes or surges on the AC line, a static electricity jolt, or other gremlins. Initialization will reset the unit and in many cases, prevent a trip to the repair shop.

Remember—any patches will be lost during initialization! Back up your patches and save your work often so that your edits will not be lost if you initialize.

1. Hold down the **Save** Voice Edit button and press the **Pause** Sequencer button. The display will show:

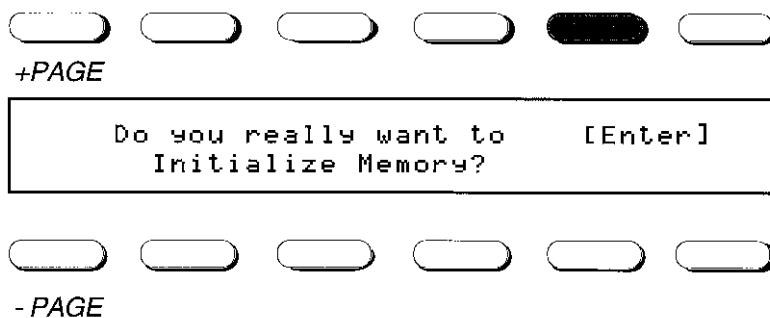

2. Press the **[ENTER]** soft key and the DPM will be initialized. Press **Exit** to abort initialization.

Chapter 3: Creating Drum Kits

3.1 DRUM KIT BASICS

The DPM contains ten special “multi-sample” waves called drum kits. These waves consist of up to 32 percussive (or melodic) wavesamples, chosen from the DPM’s set of waveforms and assigned to specific keys. To prevent confusion with other wavesamples used in other programs, the 32 wavesamples used in a drum kit are called *instruments*.

Each instrument can:

- Cover a particular range of MIDI notes
- Be tuned over a four-octave range
- Have its own decay time
- Be panned anywhere in the stereo field
- Be mixed in relation to the other drum sounds
- Send some of the effect signal to Effect 2 for additional signal processing

After building a drum kit, it remains in memory until altered and can be assigned to a program, just like any other wavesample. However, the DPM’s program voice architecture is modified for drum kit construction:

- Wave 1 is enabled and drum waves should be assigned to it.
- The following modules are disabled: Wave 2, Amp1 and Amp2, ENV1-3, LFO1 and LFO2. Drum kits are not affected by pitch bend. The main parameters to adjust in the patch program using a drum kit wave are the Filter and AMPENV v’Amp and k’Amp parameters.
- The drum kit pan assignment overrides the program’s output pan parameter.
- The drum kit output level overrides the usual program output level parameter.
- The AMPENV envelope is active, but with release time set by the drum kit decay parameter.
- Velocity sensitivity should be assigned using the v’Amp parameter in the AMPENV menu.

3.2 ACCESSING AND MODIFYING DRUM KIT PARAMETERS

The general procedure is to:

1. Press the **Global** System button. Press the **-Kits-** soft button. The screen shows:

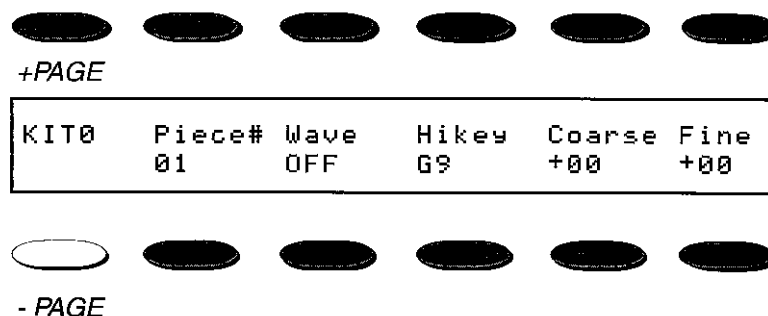

2. Select the kit to be edited (as shown in the upper left corner of the screen), with the **-Page** and **+Page**

- Select the kit to be edited (as shown in the upper left corner of the screen), with the *-Page* and *+Page* buttons.

Here's what the various soft buttons do.

- Piece# (01-32)** Chooses the “piece” (instrument) to which parameters will be assigned.
- Wave** Chooses the “oscillator” waveform from any of the available DPM samples, whether in ROM or user RAM, referenced to the sample number (samples in RAM are indicated with an R before the wave number). You are not limited to using traditional drum sound samples.
- Hikey** Each instrument is assigned to a specific key range. This parameter sets the upper note of the range; the lower note of the range is one semitone higher than the highest note of the previously-selected instrument. *Example:* If Instrument 01 covers the range of A0-D1, and Instrument 02's Key parameter is set to G1, then Instrument 02's range is D#1-G1.

If you assign a drum sound “between” existing drum sounds, the existing sounds will be reordered to accommodate the new sample. In the example given above, if you assigned Instrument 03 so that the top key is F1, Instrument 01 would cover the range of A0-D1, Instrument 03 would extend from D#1 to F1, and Instrument 02 would cover F#1-G1.

Note: An initialized drum kit assumes that you are going to build the drum kit starting from the top of the keyboard and work your way down, so all keys are set to C-1. If you want to build a drum kit starting from the bottom of the keyboard and work your way up, you might want to set all keys initially to G9.

- Coarse** Adjusts the instrument's frequency in semitone steps, from -48 (transposed down four octaves) to +48 (transposed up four octaves).
- Fine** Adjusts the instrument's frequency in cents, from -99 to +99.

Press the *+Page* button to go to the second page of Kit parameters.

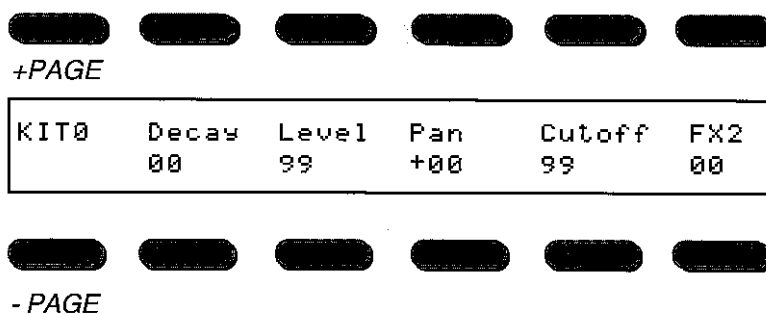

- Decay** Sets the instrument's decay time from 00 to 99 by altering the ENV4 decay parameter (T4).
- Level** Determines the instrument's level. 00 is the lowest possible level. Higher values give higher levels, up to 99.
- Pan** An instrument can be placed anywhere in a stereo (two-channel) field. -99 pans full left; moving toward 00 moves the program toward center. Moving off center toward +99 pans the program

toward full right.

- **Cutoff** Edits the initial cutoff frequency. Lower values remove harmonics, higher values let more harmonics through.
- **FX2** Sends the instrument signal to Effect 2 (see Chapter 5 on signal processing). 00 is the lowest possible level. Higher values give higher send levels, up to 99.

Application: This is useful if you want an overall drum effect but also a different effect on an individual drum. Effect 1 would provide the overall drum processing; Effect 2 the effect for the particular drum, with that drum sending some of its signal to Effect 2.

Chapter 4: Programming the DPM

Synthesizer programming is the art and science of altering the parameters of various modules to shape sounds in a particular way. Like most artistic and scientific endeavors, synth programming cannot be mastered in a day, a week, or even a year. Although this manual presents much information about synthesizer programming, it is beyond the scope of any manual to offer a complete course in programming. The best way to learn is to adjust different parameters as you play to discover how different parameter values affect the sound. Also, study the signal and modulation flow within the DPM (as shown in following block diagrams) so that you can understand what happens to a signal as it works its way from oscillator to output.

4.1 HISTORY AND BACKGROUND

Early synthesizers consisted of various hardware modules, some of which generated signals, and some of which modified those signals. To create as general-purpose a device as possible, *patch cords* connected the inputs and outputs of the various signal generating and processing modules (which is why particular synth sounds were called *patches*). Changing a patch involved manually repositioning patch cords and adjusting knobs and switches; recreating a patch at some later time required writing down all the patch settings on paper so they could be duplicated later. Even then, due to the vagaries of analog electronics, the patch might not sound exactly the same.

Over the years, certain combinations of modules seemed to work better than others, and since patch cords were troublesome to deal with, eventually these modules were wired together in a “normalized” configuration. Synthesizers such as the Minimoog, Prophet-5, and others eliminated the need for patch cords by containing a normalized collection of sound modules.

4.1a How the DPM Generates Sound: Analog Synthesizer Emulation and Sampling

The DPM uses general-purpose Digital Signal Processing (DSP) chips for sound generation. These chips are essentially computers designed to generate and/or process digital audio signals, and can even do special effects like chorusing and reverb. The DPM’s three DSP chips are, in turn, controlled by a central computer. Because the function of these chips depends on the software controlling them, it is possible to upgrade the DPM with entirely new methods of sound generation by writing new software for the central computer.

The current generation of DPM software offers two different but related options.

- **Analog synthesizer emulation.** This offers the types of sounds and programming functions associated with a top-of-the-line classic analog synthesizer, but with digital sound-generating capabilities. Instead of being limited to a few basic waveforms, the DPM includes traditional analog waveforms (sine, sawtooth, square, etc.) but also a wide variety of sampled waveforms for extremely realistic sounds.

Each synthesizer “module” is a page on the display (also called a display *screen*), and each “knob” or “switch” is a parameter on the screen, which you can edit. All “patching” is done via software, eliminating the need for patch cords; you simply specify which inputs should receive which outputs in those cases where connections are not normalized.

You can take a “snapshot” of the DPM’s parameters for a particular sound and save this in memory as a *program*. The DPM stores 100 programs on-board and another 100 on a RAM or ROM cartridge card that plugs into the rear-panel card slot (DPM 4), so 200 programs are instantly accessible at any time.

- **Sampler.** You are not limited to the waveforms that come with the DPM, but can load in samples from a variety of sources via MIDI (another DPM, computer visual editing programs, other samplers, etc.) or directly from disk. Samples can be up to 1 Megabyte long in a DPM with fully expanded memory; the shorter the samples, the more of them you can fit in the DPM’s memory. Several third party developers, including Prosonus, offer ready-to-use samples in DPM format.

Samples can also be recorded from acoustic or electric sources into the Peavey SX Sample Expander. Once in SX memory, the sample or samples can then be transferred over to the DPM.

Once loaded into the DPM, samples can be looped, truncated, named, etc. These samples can be programmed into patches, just like the on-board waves. The DPM memory is nonvolatile, so samples remain in memory even if power is turned off. Samples can be saved to and loaded from the DPM’s internal disk drive.

4.1b DPM Synthesizer Architecture

The following figure shows the signal flow for a single wave DPM voice (total of thirty-two voices).

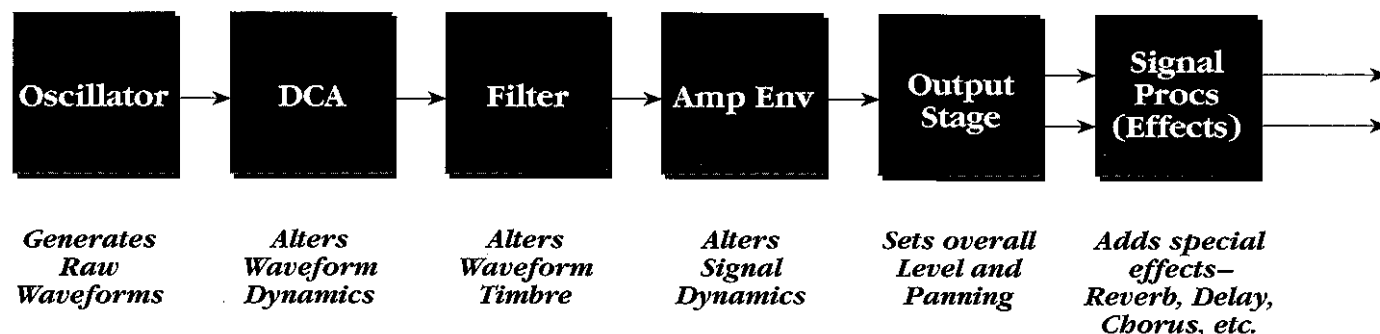

The following figure shows the signal flow for a dual wave DPM voice (total of sixteen voices).

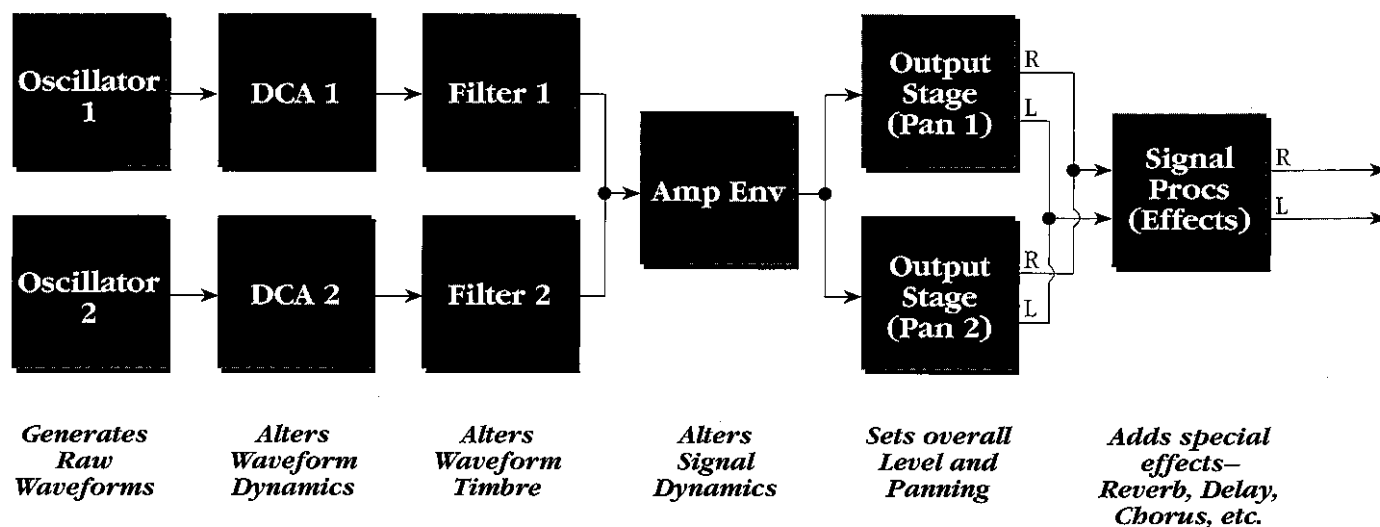

4.1c Oscillators

The two digital oscillators (WAVE1 and WAVE2) provide the actual raw sounds, called *waves*. These can draw from any of the 174 on-board wavesamples (and ten drum kits) or from samples you load into memory. Both oscillators allow for adjustable wave pitch and two *modulation* sources. Modulation is the process of varying a parameter dynamically over time; with the oscillators, the pitch can be modulated by various control sources, as described later.

4.1d DCAs

Each oscillator is followed by a DCA, which can modulate the level of the wave either statically (you set a particular volume level), dynamically (the level changes over time in a specific way), or a combination of the two.

Having two DCAs allows for, among other effects, cross-fades between the two oscillators. *Example:* One DCA could fade out a flute sound while the other DCA fades in a synth waveform to create a synth flute sound. Section 9.3 includes additional information on cross-fade techniques.

The “Amp Env” is a third DCA that follows the filter. It can only be modulated by Envelope 4, and generally sets the overall dynamics.

4.1e Pan

This sets the panning modulation of the effects processors.

4.1f Filters

A lowpass filter varies a signal’s harmonic content by progressively increasing attenuation above a specified *cutoff frequency*. Higher cutoff frequencies give a brighter sound; lower cutoff frequencies give a “bassier” sound since fewer harmonics are present.

The filter’s *resonance* specifies the amount of gain at the cutoff frequency. Higher settings produce a sharper, more resonant sound. The following figure correlates the cutoff frequency and resonance parameters.

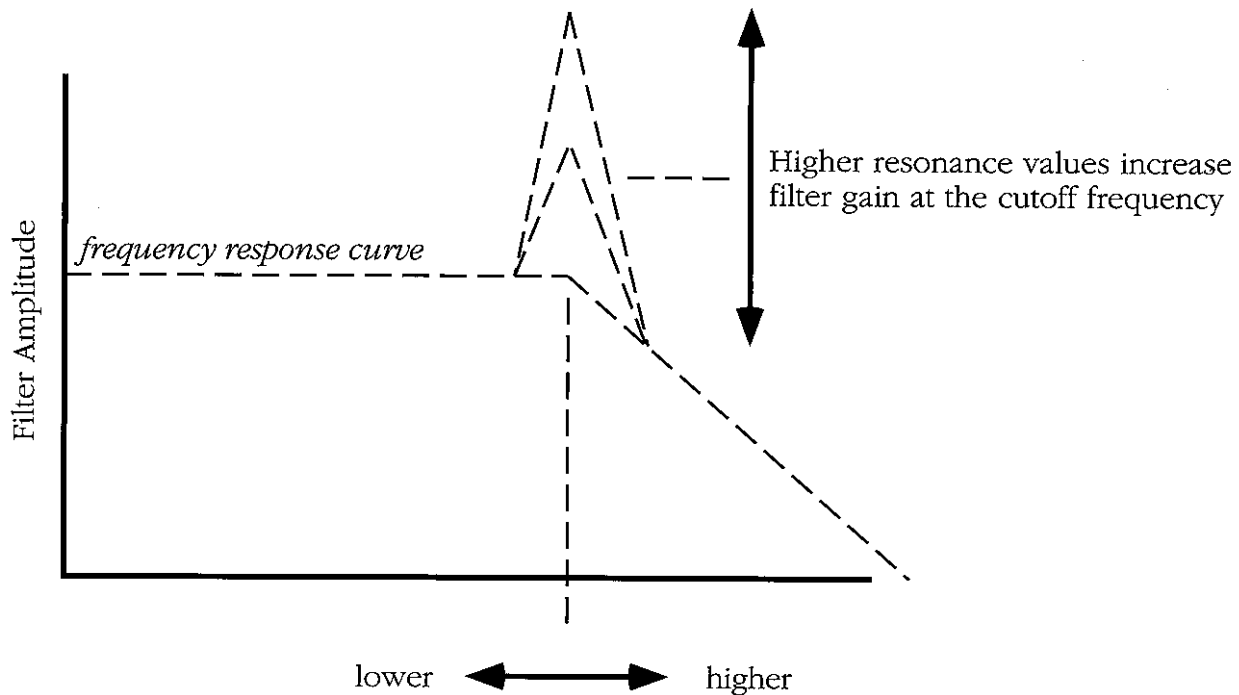

The cutoff parameter changes the frequency at which high-frequency response starts to fall off

Although static filter settings are useful, varying the filter cutoff dynamically over time often produces more interesting effects. Modulating with velocity can produce brighter sounds with louder dynamics, giving a sound more like an acoustic instrument. Modulating with an envelope can create a particular change in harmonic structure, such as the increase in harmonics that happens when more wind is blown into a brass instrument.

Note that filter and DCA settings can interact. For example, the filter cutoff can be so low that no signal can get through. Also, if the DCA is set for a short decay, then you won't hear a long filter decay because the volume will reach zero before the filter decay finishes (see the following diagram).

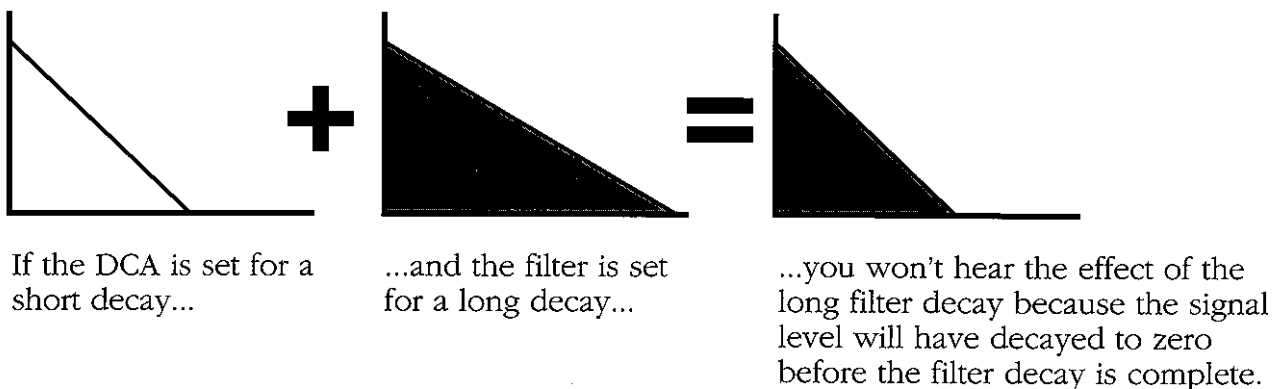

The combination of two oscillators, two DCAs, one filter, a final DCA, and various modulation sources is called a *voice*.

4.1g Output Stage

This stage controls overall volume, panning (placement in the stereo field), pitch bend amount, and the amount of signal sent to one of the two effects processors.

4.1h Signal Processors

There are two independent effects (fx for short) units. Each one can include one (Single mode) or two (Dual mode) effects, giving a possible total of up to four signal processing “modules” in all. The basic signal processing options (in addition to Bypass, where the effect module has no effect) are Reverb, Delay, Chorus/Flange, EQ, Gated Reverb, Distortion, and Exciter. Dual mode effects include Reverb/EQ, Chorus/Delay, EQ/Gated Reverb, etc. (as listed in section 4.1a).

4.2 THE ART OF MODULATION

4.2a About the DPM Modulation Matrix

Modulation modifies some aspect of a sound over a period of time. Since synthesizers inherently make static sounds (unlike acoustic instruments, whose timbre and dynamics change—often radically—over the duration of a note), modulation can be the key to making rich and expressive sounds. The DPM has a variety of modulation sources, shown in the diagram on page 46. Here’s an overview of the main modulation categories (section 4.2b provides a more complete description):

- Modulation signals generated by the way you play the keyboard or other controller driving the DPM (velocity, note position, and pressure)
- Envelope generators (these produce a programmable modulation change over time)
- LFOs (these produce periodic, cyclic modulation changes over time, such as vibrato or tremolo)
- Performance controls (modulation wheel, foot pedal, and data slider, which are designed to be manipulated in real time, as you play)
- External MIDI control. This allows external MIDI control signals (e.g., from a sequencer) to control some aspect of the DPM’s sound.

The DPM arranges its modulation source outputs and modulation destination inputs into a “matrix” so that virtually any output can feed virtually any input. The Wave, DCA, Filter, and Pan modules have two independent inputs that can be assigned to any modulation source. The LFO has two independent inputs that control modulation amplitude (depth), but also has a third input that controls modulation rate.

There are also some normal connections where a particular modulation input permanently connects to a particular modulation source. The AMPENV module is normed to Envelope 4 only; the Envelope Generator Time and Level parameters are normed to the velocity and note position modulation sources only.

Each non-normed modulation input includes two parameters: *modulation source* (including OFF if no modulation is desired) which lets you choose from the various modulation sources mentioned above, and *modulation amount*.

The modulation amount can be positive or negative. With positive amounts, an increasing control signal increases the value of the parameter being controlled. With negative amounts, an increasing control

signal *decreases* the value of the parameter being controlled. A setting of 00 is equivalent to turning off the modulation source.

Note that having two modulation inputs available allows for interaction between two modulation signals. *Example:* If a parameter responds to keyboard velocity and an envelope generator, the parameter will follow the general envelope shape but also be influenced by the velocity.

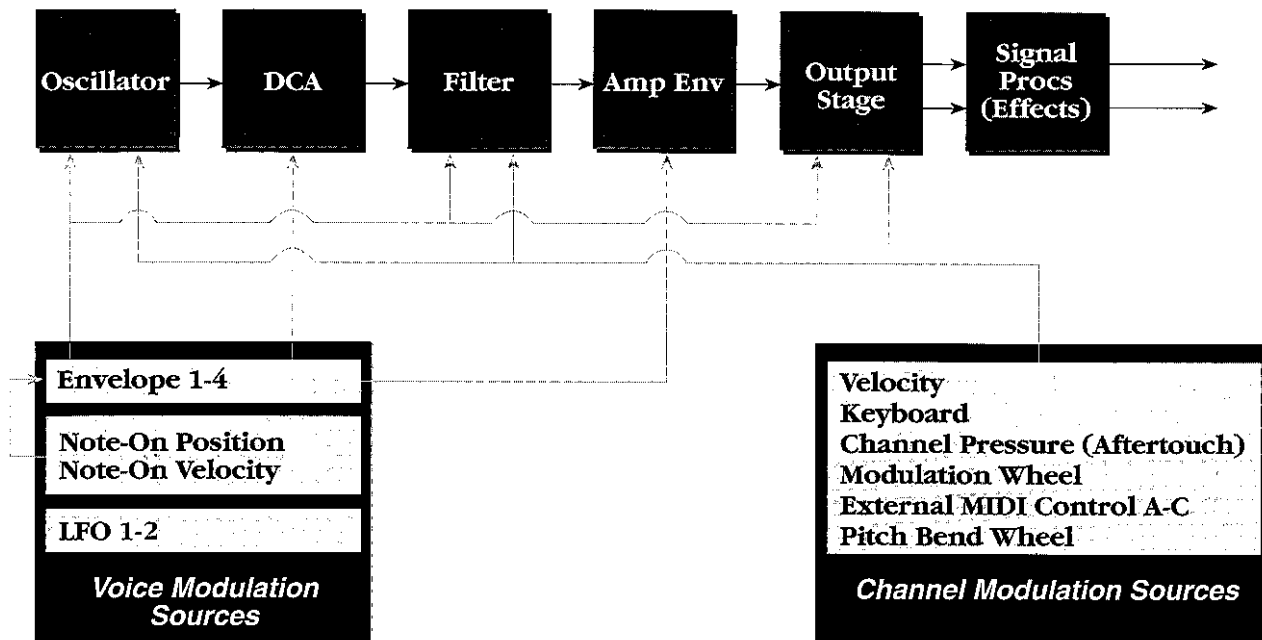

If a “baseline” setting exists, modulation amounts add or subtract values from that setting. *Example 1:* If the filter cutoff is set to a certain frequency, positive modulation amounts will increase that frequency, and negative modulation amounts will decrease that frequency. However, modulation cannot force a value beyond its maximum range. *Example 2:* If the filter cutoff is at the lowest possible frequency, then maximum positive modulation will vary the filter cutoff from the lowest to the highest frequency. Applying negative modulation will not affect the filter frequency because if it’s at its lowest value, it cannot go any more negative.

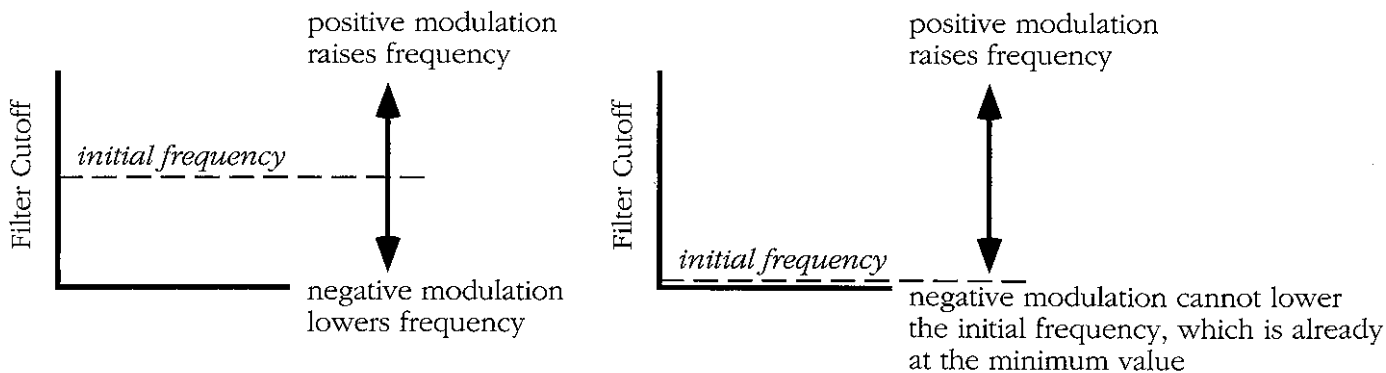

4.2b DPM Modulation Modules

The following provide modulation signals.

- **Keyboard Modulation Sources** These modulation signals are generated when you play a keyboard or other controller.

Velocity produces data relating to how fast a key goes from the key up (note off) to the key down (note on) position. This relates to the dynamics of your playing.

Note Position produces data relating to the note played on the keyboard. You would use this modulation source if you wanted, for example, a different sound in the upper and lower registers.

Pressure produces data relating to how hard you press on the keyboard after the keys are down. One way to use this would be to add vibrato, or increase brightness, as a note sustains.

- **Pedal** The pedal can not only serve as a modulation source where the value depends on the pedal position, but as a volume pedal or an assignable external controller. This is covered in section 2.5.
- **Wheel** The mod wheel is traditionally used for adding vibrato, but can also vary volume, level, filter cutoff, LFO rate, or any other parameter that can be modulated.
- **External MIDI Control** If you need more control than that afforded by the pedal and wheel, controller signals from a sequencer, breath controller, other synthesizer, etc. can enter the DPM via MIDI and vary parameters that can be modulated in real time. See section 2.5.

- **LFOs (Low Frequency Oscillators)** The DPM includes two independent LFOs, each of which creates a cyclic (periodic) modulation of synthesizer parameters such as pitch, volume, or filter cutoff. The amount of LFO modulation can be constant and/or modulated.

Example: Applying a periodic modulating signal to the oscillator produces vibrato.

Applying LFO modulation to the VCA produces tremolo; modulating the filter cutoff with an LFO signal produces a wa-wa effect or, if used subtly in the higher registers, a shimmering type of sound.

- **Envelopes** There are four independent envelope generators, each of which provides a modulation signal that varies over time. Applying it to different modulation destinations produces different results. *Example:* Sending the envelope to a DCA creates changes in level. If the amplitude decays over time, percussive effects (plucked strings, drums, etc.) will result; brass, woodwind, and some bowed instruments have amplitudes that increase over time. A note-on message triggers each envelope.

Each envelope generator has five Level and four Time parameters. The Time parameter sets the transition time from one Level to another. Levels and Times range from 0 (minimum level or time) to 99 (maximum level or time). For background information on envelopes, see section 9.2.

4.3 DPM PROGRAMMING TECHNIQUES

Now that we've covered the basics, let's look at the available synth parameters. The following pages show the displays called up by the Voice Edit buttons, along with descriptions of what each display's

“soft buttons” do. This is intended as more of a reference manual; remember that Chapters 8-10 contain applications information in case you are not very familiar with synthesis, or are interested in additional information.

Important: In order to save space (there’s a lot to discuss here!), we’ll assume that you know how to select pages and parameters, as described earlier in the manual.

4.3a About the Compare Function

When you edit a DPM program, you are actually editing a copy of the program that resides in a special memory buffer. This has two important ramifications:

- To retain the results of your edit, you must save it to a particular program location as described in section 2.4a. If you switch program locations before saving, your edits will be lost.
- Because the original program remains undisturbed, you can compare the edited version to the original program by pressing the **Compare** System button. The display will say “Comparing Edited Program to Original” and show the program name. Press the **Compare** button again to return to editing.

The following pages describe the screens and parameters that appear by pressing the Voice Edit buttons, and how adjusting these parameters affects the overall sound.

4.3b1 Wave Page 1

Wave 1 and 2 (access by pressing the **Wave** Voice Edit button) include identical parameters.

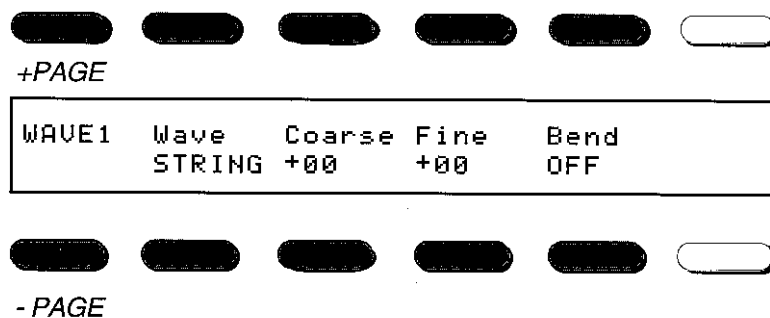

Wave

Selects one of the available waveforms (see list on page 48). Each waveform has its own unique sound.

Coarse (-48 to +48 semitones)

Adjusts the wave pitch in semitone steps, from -48 (transposed down four octaves) to +48 (transposed up four octaves).

Fine (-99 to +99 cents)

Adjusts the pitch from -99 to +99 cents.

Bend

This determines how much the wave pitch varies in response to pitch bend wheel travel.

Options:

Off - not affected by the pitch wheel

Half - half step	Fifth - perfect fifth
Whole - whole step	M6th - minor sixth
M3rd - minor third	Sixth - major sixth
Third - major third	M7th - minor seventh
4th - perfect fourth	7th - major seventh
DM5th - diminished fifth	Octve - octave
2Oct - 2 octaves	

The bend value will apply to all links of a Combi program.

Example: If set to a whole tone, rotating the pitch bend wheel all the way from you will increase the pitch by a whole tone, and rotating the pitch bend wheel all the toward you will decrease the pitch by a whole tone.

Waveform Reference List

- **Analog synth** Sine (no harmonics; very pure), Triangle (weak even harmonics; clarinet-like), Sawtooth (odd and even harmonics; brass-like), Square (strong odd harmonics; hollow-sounding), Pulse (pulse waveforms have various harmonics missing and are reedy: 25%, 20%, 15%, 10%, 5%)
- **Digitally generated** DGW1-5, Cycle1-6
- **Non-harmonic** Spec1, Spec3-5
- **Combination loops** C Loop, ABCHR, Koto, Chimes
- **Organ** Pipes, Full B3, Jazz B3, Organ1, Organ2, Percussive Organ, New B3, 2' B3, Pipe Organ1-3
- **Bells** Bell 1-4
- **Bass** Fingerbass, Pick Bass, Fretless, Slap Bass, Acoustic Bass, Syn Bass, Synth Bass2-4, FM Bass
- **Pianos** Piano, Electric Piano Loop, Electric Piano1-5, Harpsichord, Electric Piano Tine, RhodeH, Rodes, Clav
- **Guitars** Steel Guitar, Electric Guitar1-3, Harmon, Nylon Guitar, Muted Guitar
- **Orchestral** String, Orkhit, Cello, Pizzicato Cello, Violin, Pizzicato Violin, Orkhit2
- **Voices** Abbey, Male
- **Accordions** Accordion, Harmonica, Squeezebox
- **Noise** Lightning, Breath, Steam, Bottle
- **Woodwinds/Brass Instruments** Flute, Flute2, Flute3, Clarinet, Oboe, Sax, Trumpet 1, Trombone, Synth Brass, Trumpet2, Muted Trumpet, French Horn, Rock 7 Roll Horns, Tuba, Bass Clarinet, Bassoon
- **Tuned Percussion** Woody (marimba), Metal (struck), Vibes, Vibes2
- **Standard/Latin Drums** Tom1, Tom2, Conga, Timbale, Taiko, Gambng (Gamelan variation), gamelan, Kalimba, Agogo, Cowbell, Clave, Tambourine, Cabasa, Claps, Triangle, Pole, Scratch (turntable), High hat closed, High hat open, Ride, Crash, Reverse Cymbal, Electric Tom, Kick1-5, Snare1-4, Sidekick, Large Bongo, Small Bongo, Vibraslap, Claves2, Samba Whistle
- **Brushed Drums** Brushed, Brushed Snare1-4, Brushed Hi Hat1-3, Brushed Tom1-2, Brushed Open Hi Hat, Jazz Kick Drum
- **Orchestral Percussion** Orchestral Crash Cymbal, Timpani, Military Snare Drum
- **Rap Drums** Rap, Bass, Rap Cowbell, Rap Kick, Rap Clav, Rap Snare1-2, Rap Claps, Rap Closed High Hat, Rap Open High Hat, Rap Scratch
- **Fx** Vault Fx, Vocal Fx1-3

4.3b2 Wave Page 2 (Mods)

Once a wave is selected pressing the *+Page* button will take you to the MODS page.

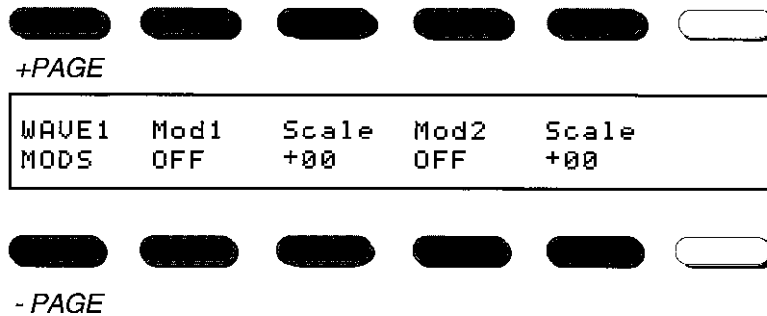

Mod1/Mod2

Chooses the pitch modulation source. Select from: Off, Velocity, Keyboard, Pressure, Envelope 1-4, LFO 1-2, Mod Wheel, Foot Pedal, External MIDI Control A-C, Pitch Bend Wheel.

Scale (-99 to +99)

Sets the modulation degree and polarity (positive or negative) for the selected modulation source.

4.3c1 Amplitude Page 1

These digitally-controlled amplifiers (access by pressing the **Amp** Voice Edit button) include identical parameters.

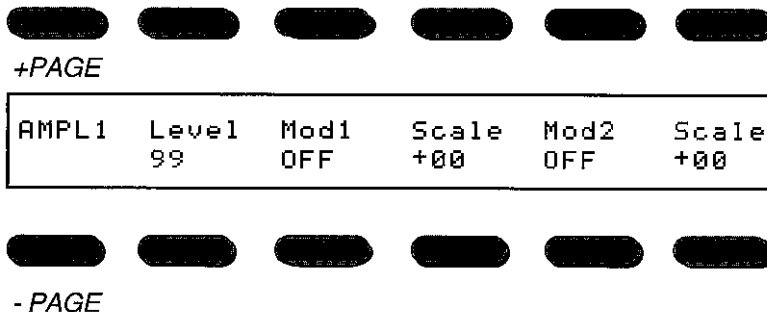

Level (0 to 99)

Selects the Amplitude baseline level. Lower values are softer, higher values are louder.

Mod1/Mod2

Chooses the pitch modulation source. Select from: Off, Velocity, Keyboard, Pressure, Envelope 1-4, LFO 1-2, Mod Wheel, Foot Pedal, External MIDI Control A-C, Pitch Bend Wheel.

Scale

Sets the modulation degree and polarity (positive or negative) for the selected modulation source.

4.3c2 Amplitude Page 2

Once an amplifier is selected pressing the *+Page* button will take you to the second page.

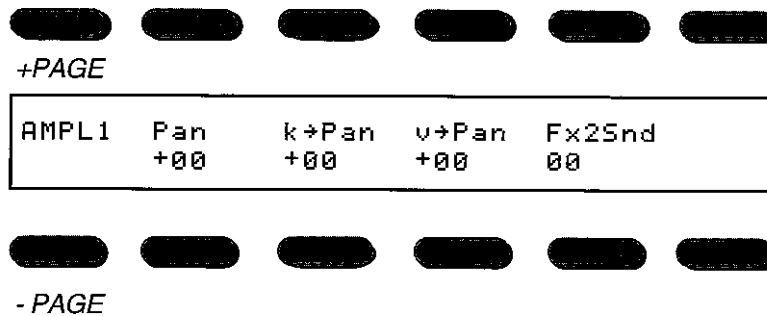

Pan (-99 to +99)

A program can be placed anywhere in a stereo (two-channel) field of the chosen bus or buses. -99 pans full left; moving toward 00 moves the program toward center. +99 pans the program full right.

Note: The addition of effects can alter the apparent pan of the program. Also, if the oscillator wave is set to a drum kit, this parameter is ignored, and the drum kit instrument's pan is used. In this case, instead of a value, the word KIT will be shown.

k→Pan (-99 to +99)

Keyboard Note Position modulation (k→Pan) ties the envelope generator levels to keyboard note position. This is useful if you want a note's overall amplitude to depend on where you play it on the keyboard. The relationship between envelope levels is preserved; these changes scale the levels rather than force them to all jump to the same level.

A k→Pan setting of 0 means that the envelope level will not be affected by where you play on the keyboard. With positive values, the levels will increase as you play from left to right on the keyboard. With negative values, the levels will decrease as you play from left to right on the keyboard.

v→Pan (-99 to +99)

Keyboard Velocity (v→Pan) ties the envelope generator levels to velocity. The relationship between envelope levels is preserved; v→Pan scales the levels rather than forcing them to all jump to the same level.

With v→Pan set to 0, velocity will not affect the envelope levels. Positive values increase the envelope levels according to your dynamics up to the maximum pre-programmed levels. The higher the value, the lower the envelope levels go when you play softly. +99 gives the maximum dynamic range. Negative values decrease the envelope levels according to your dynamics; the more negative the value, the more the envelope levels will tend to go toward 0 when you play harder. -99 gives the maximum dynamic range.

Fx2Snd (0 to 99)

This parameter determines the amount of straight signal sent to Effect 2.

Positive Modulation Amount Applications

- **Velocity** Level tracks the dynamics of your playing
- **Keyboard** Notes become louder as you play higher up on the keyboard

- **Pressure** Increases the wave level with increased keyboard pressure
- **Envelopes** Create specific changes in dynamics over time
- **LFO** Adds tremolo effects
- **Mod Wheel** Selects the mod wheel as a volume control for the wave
- **Footpedal** Provides foot-controlled volume
- **External MIDI Control** Alters parameters via a particular MIDI continuous controller sent by a sequencer or another keyboard.

4.3d1 Filter Page 1

There are now two filters (access by pressing the **Filter** Voice Edit button), each have identical parameters.

FILT1	Cutoff	Res	Curve	Pivot	k→Fc
	99	00	Linear	C2	+00

Cutoff (0 to 99)

Edits the filter's initial cutoff frequency. Lower values remove more harmonics, giving a more dull sound; higher values let more harmonics through, giving a brighter sound. Harmonically complex signals (like sax) are most affected by the filter.

Res (0 to 99)

This sets the amount of gain at the filter's cutoff frequency. Higher settings give sharper, more "whistling" effects. *Caution:* High resonance values can lead to distortion at high system levels.

Curve (Linear or Exponential)

This sets the filter curve to either a linear or exponential curve.

Pivot (C2 - C7)

This is the split point for keyboard modulation.

k→Fc (-99 to +99)

This is the keyboard scaling of the filter cutoff value.

4.3d2 Filter Page 2 (Mods)

Once a filter is selected pressing the *+Page* button will take you to the MODS page.

+PAGE

FILT1	Mod1	Scale	Mod2	Scale
MODS	OFF	+00	OFF	+00

- PAGE

Mod1/Mod2

Chooses the pitch modulation source. Select from: Off, Velocity, Keyboard, Pressure, Envelope 1-4, LFO 1-2, Mod Wheel, Foot Pedal, External MIDI Control A-C, Pitch Bend Wheel.

Scale (-99 to +99)

Sets the modulation degree and polarity (positive or negative) for the selected modulation source.

Modulation Applications

Use velocity as a modulation source, with a fairly low cutoff value and positive modulation amount, for a brighter sound as you play higher-velocity notes. This helps simulate the way acoustic instruments sound. When using negative modulation, the filter cutoff should be set to the upper limit of the intended range, since increased modulation will drive the filter to a lower cutoff level.

4.3e1 Envelope Page 1 (Levels)

All four envelopes include the same parameters. *Exception:* with AmpEnv (ENV4), L0 always equals zero. Envelopes 1 through 3 are accessed with the **Aux Envs** Voice Edit button and envelope 4 is accessed through the **Amp Env** Voice Edit button.

+PAGE

ENV1	L0	L1	L2	L3	L4
LEVELS	00	99	54	46	00

- PAGE

Levels (00 to 99)

The five envelope level parameters (L0-L4) are variable from 00 (minimum level) to 99 (maximum level). The line above traces a typical envelope.

4.3e2 Envelope Page 2 (Level Mods)

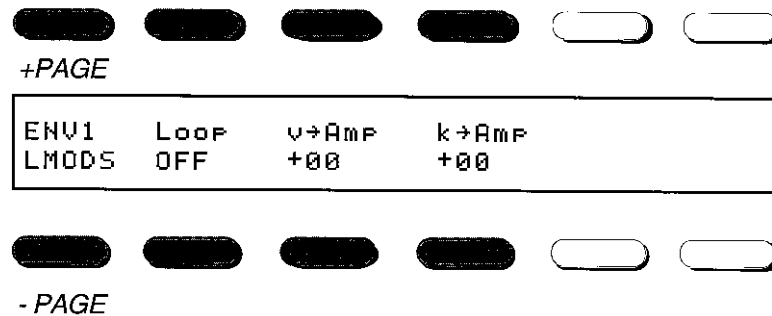

Loop

Looping allows you to repeat steps in Envelopes 1-4 between the sustain level and any of the previous points in the envelope. The progression between level 3 and the previous point can be looped as a forward progression (0→→3K, 1→→3K, 2→→3K or 0→→3I, 1→→3I, 2→→3I) or a backward-forward progression (0←→3K, 1←→3K, 2←→3K or 0←→3I, 1←→3I, 2←→3I). ('K' indicates that the envelope will repeat as long as the key is held. 'I' indicates that the envelope will repeat as long as the note is sounding, even though the key has been released.)

Note: Although Envelope 4 (amplitude envelope) can be looped, it can only be looped while a key is held (i.e., any of the 'K' options listed). (Actually, if you were allowed to loop the amplitude envelope while a note sounded, it would never turn off!)

v→Amp (-99 to +99)

Keyboard velocity (v→Amp) scales envelope generator levels according to velocity.

With v→Amp set to 0, velocity will not affect the envelope levels. Positive values increase the envelope levels according to your dynamics up to the maximum pre-programmed levels. The higher the value, the lower the envelope levels go when you play softly. +99 gives the maximum dynamic range.

Negative values decrease the levels according to your dynamics; the more negative the value, the more the envelope levels will tend to go toward 0 when you play harder. -99 gives the maximum dynamic range.

k→Amp (-99 to +99)

Keyboard note position modulation (k→Amp) ties the envelope generator levels to keyboard note position. This is useful if you want a note's overall amplitude to depend on where you play it on the keyboard. The relationship between envelope levels is preserved; these changes scale the levels rather than force them to all jump to the same value.

A k→Amp setting of 0 means that the envelope level will not be affected by where you play on the keyboard. With positive values, the levels will increase as you play from left to right on the keyboard. With negative values, the levels will decrease as you play from left to right on the keyboard.

4.3e3 Envelope Page 3 (Times)

All four envelopes include the same parameters.

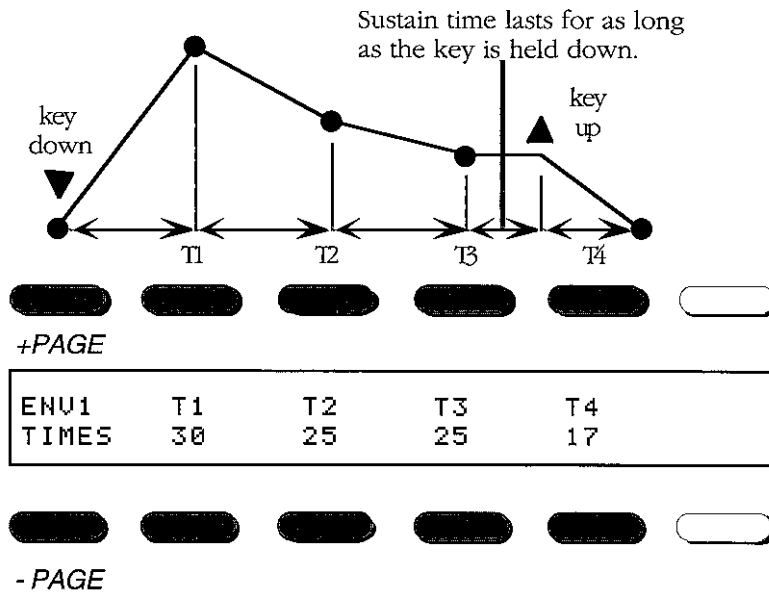

Times (00 to 99)

The four envelope time parameters (T1-T4) are variable from 0 (minimum time) to 99 (maximum time). The line above traces a typical envelope.

4.3e4 Envelope Page 4 (Time Mods)

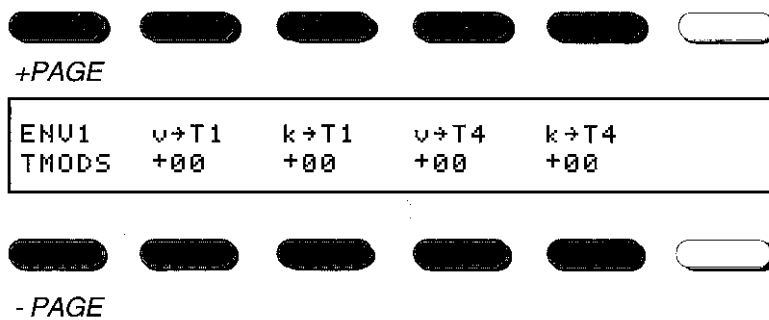

v→T1 (-99 to +99)

Keyboard velocity (v→T1) ties the T1 envelope generator time to velocity.

A v→T1 setting of 0 means that the envelope times will not be affected by velocity. If T1 sets an attack time (i.e., L1 has a lower value than L2), positive values increase the attack time as you play harder; negative values decrease the attack time as you play harder. The latter is useful for sounds (wind, voice, etc.), which have a sharper attack when played forcefully.

If T1 sets a decay (i.e., L1 has a higher value than L2), positive values increase the decay time as you play harder; negative values decrease the decay time.

k→T1 (-99 to +99)

k→T1 ties T1 (attack time) to keyboard note position. As you play higher up on the keyboard, positive values increase the attack time and negative values decrease the release time.

v→T4 (-99 to +99)

v→T4 ties T4 (release time) generator to velocity.

k→T4 (-99 to +99)

k→T4 ties T4 to keyboard note position. Since T4 sets the release time, k→T4 is most effective with percussive sounds. As you play higher up on the keyboard, positive values increase the release time and negative values decrease the release time.

The effect of k→T4 increases drastically at longer delay times. Set k→T4 to lower values at first (e.g., -10 or +10, depending on how you want release time to track the keyboard) and try adjusting T4, the release time, to arrive at the desired decay curve. Go back and forth between T4 and the k→T4 setting until you achieve the desired sound.

4.3f1 LFO Page 1

Both LFOs include the same parameters and a second page for modulation.

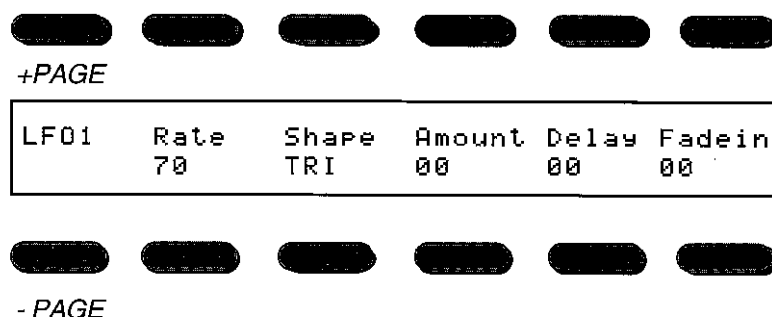





Rate (00 to 99)

Varies the LFO speed, slow (00) to fast (99).

Shape

There are five LFO waveforms.

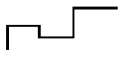
-  **TRI** (triangle) Equal rise and fall times. Useful for vibrato and tremolo.
-  **SAW** (sawtooth) Rises to maximum level, snaps back to zero.
-  **Ramp** Falls to minimum level, snaps back to maximum.
-  **SQR** (square) Alternates between minimum and maximum values; useful for trills.
-  **RNDM** (random) Each LFO cycle produces a randomly-generated level; useful for sound effects and adding randomized pitch variations.

Amount (00 to 99)

This sets the maximum signal level generated by the LFO, from minimum (00) to maximum (99). Since the modulation Scale parameter, found on all MOD pages, can also vary the signal level received from the LFO, when it has been chosen as the modulation source, this parameter may seem redundant. Example: Assume you've set up LFO routing to the wave and filter, then decide you'd like to lower the overall LFO depth. Rather than re-adjust the wave and filter parameters, simply reduce the LFO amount.

Caution: If the LFO amount doesn't seem to add LFO, make sure LFO is selected for the parameter you are trying to vary. Also, make sure the corresponding Scale parameter is not +00.

Delay (0 to 99)

If this parameter is not 0, the signal level generated by the LFO will fade from 0 to the maximum set by the Amount parameter. The higher the value, the longer the fade will take.

Fadein (0 to 99)

Sets the duration over which the LFO modulation fades in (unlike delay, where the modulation comes in at the programmed level after the delay period has elapsed). Delay settings greater than 00 deactivate fade-in.

4.3f2 LFO Page 2 (Mods)

Both LFOs include a modulation page (selected from the main LFO page, previous section) which allows for varying amount with two different modulation sources, and LFO rate to a single modulation source.

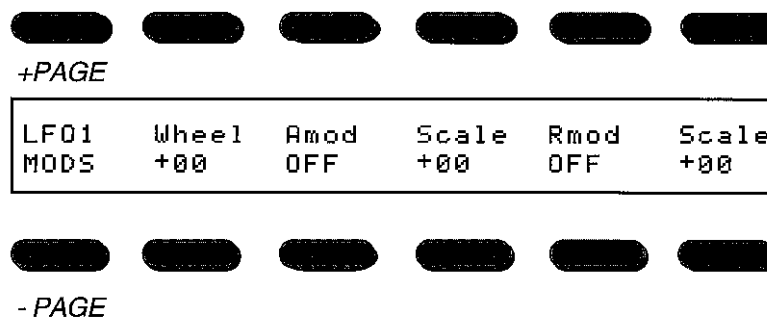

Wheel (-99 to +99)

This sets the modulation degree and polarity (positive or negative) of the Mod Wheel modulation source independent of the **Amod** modulation source. A setting of +00 turns this parameter off.

Amod

Chooses the LFO amount modulation source. Select from Off, Velocity, Keyboard, Pressure, Envelope 1-4, LFO 1-2, Mod Wheel, Foot Pedal, External MIDI Control A-C and Pitch Bend Wheel. When Off, the LFO amount is set solely by the amount parameter on the first LFO page.

Scale (-99 to +99)

Sets the modulation degree and polarity (positive or negative) from the previously selected source. This modulates the base line rates by the LFO's Rate parameter on the first page.

Rmod

Chooses the LFO rate modulation source. Select from Off, Velocity, Keyboard, Pressure, Envelope 1-4, LFO 1-2, Mod Wheel, Foot Pedal, External MIDI Control A-C and Pitch Bend Wheel. When Off, the LFO rate is set solely by the rate parameter on the first LFO page.

Scale (-99 to +99)

Sets the modulation degree and polarity (positive or negative) from the previously selected source. This modulates the base line rates by the LFO's Rate parameter on the first page.

LFO Modulation Applications

(Scale) Use pressure to increase the amount of LFO modulation as you press harder on a key once it is down. This is very useful for adding expressive vibrato effects. Use the footpedal to provide foot-controlled LFO modulation.

(Rate) Use an envelope to change the rate over time; a slight attack time will increase the rate.

4.3g Volume Page

This page edits volume and its associated signal processing effect. Each program has an associated signal processing effect, named and numbered the same as the program. This page lets you edit the amount of the signal feeding effects processor 2 (the Fx2 parameter). Chapter 5 has more information on effects.

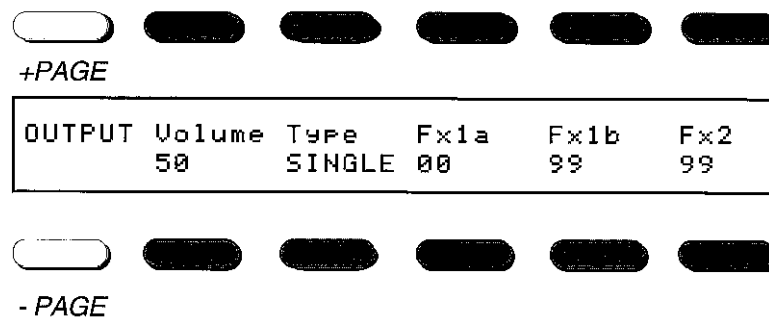

4.3h1 Links Page 1

A Combi program links up to 3 additional programs to a “foundation” program to create split and layer programs. The first link is the foundation program; the other three links can be any other programs in the DPM, which are specified as you program the Combi.

In a *split* program, certain sounds cover only a certain range of the keyboard. A Combi allows up to three split points and four split. *Example:* Acoustic bass in the lower two octaves and trumpet in the upper octaves lets you play trumpet melodies with your right hand against left-hand bass parts.

In a *layered* program, pressing down on a key will play two or more sounds simultaneously. A common example is layering strings and piano on one key. A Combi allows up to four programs to be layered.

Each link can also respond to a specific velocity range, and splits and layers can be combined. The following figure shows a typical Combi “map”—Bass from C1-G2, Piano from A2-B4, Brass from A2-C6, and Strings from C5 to C6. Strings are layered with the upper octave of brass; play in the range C5-C6 to hear both strings and brass, and play from A2-B4 to hear both piano and brass. Brass has been set for a low velocity of 64 and high velocity of 127, so velocity values must be 64 or more to trigger the brass layer.

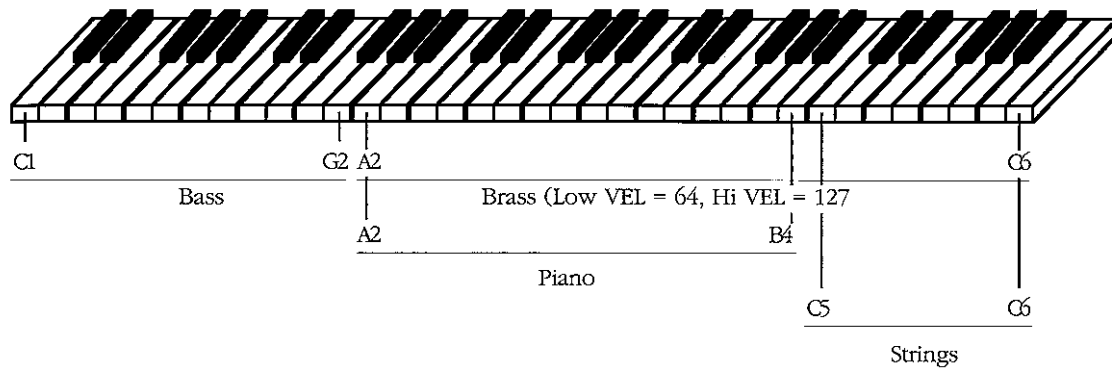

Furthermore, each link that makes up the split or layer can respond to a specific velocity range. One application would be to layer standard brass and slap bass sounds together, and have low velocity notes trigger the standard brass and high velocity notes trigger the slap sound. In the example above, Brass has been set for a low velocity of 64 and high velocity of 127. Thus, velocity values must be 64 or more to trigger the brass layer.

Each link can be delayed (up to 900 ms), detuned (± 99 cents), transposed (± 12 semitones), and have its own volume level and MIDI channel assignment. If you're starting to think this can make some really great sounds, you're right. Just remember that layered sounds use up more voices if more than one voice plays at the same time.

Using the link volume modulation, you can cross-fade between link programs with channel pressure, modulation wheel, etc.

Major Big-Time Caution: A Combi references other programs not by their names, but by their locations in memory. If you change the program location of a program that is referenced by a Combi, you will change the sound of the Combi.

+PAGE

LINK1	Program 055	Vol 99	VolMod OFF	Scale +00
	Enorms			

-PAGE

Vol (0 to 99)

Selects the link's volume level.

VolMod

Chooses the Link Volume modulation source.

Scale (-99 to +99)

Sets the modulation degree and polarity (positive or negative) from the previously selected source. This modulates the base link volume setting above.

4.3h2 Links Page 2



+PAGE

Link1	LoVel	HiVel	LoKey	HiKey
	000	127	C-1	G9



-PAGE

LoVel (0 to 127)

The selected link will not play if the note velocity is lower than this value. *Example:* To have a link play only if the velocity is between 064 and 127, set LoVel to 064.

HiVel (0 to 127)

The selected link will not play if the note velocity is higher than this value. *Example:* To have a link play only if the velocity is between 000 and 080, set HiVel to 080.

LoKey (C-1 to G9)

This sets the low end of the link's key range. *Example:* To have a link play only in the range of C2-G3, set the LoKey to C2.

HiKey (C-1 to G9)

This sets the high end of the link's key range. *Example:* To have a link play only in the range of C2-G3, set the HiKey to G3.

Applications: Here is an example of a Combi program with velocity switching. Set Link1 with LoVel at 000, HiVel at 063, and its program set to a bass guitar. Set Link2 with LoVel at 064, HiVel at 127, and its program set to a slap bass. The key range for both links should be from C-1 to G9. Playing the keyboard lightly will play the regular bass. Playing harder will cause the bass to slap. One of the two sounds will always respond to the keyboard, but never both at the same time.

4.3h3 Links Page 3



+PAGE

LINK1	Pan	Fxsnd	Detune	Xpose	Delay
	+00	28	+00	+00	000



-PAGE

Pan (-99 to +99)

A program can be placed anywhere in a stereo (two-channel) field. -99 pans full left; moving toward 00 moves the program toward center. +99 pans full right.

Fx2snd (0 to 99)

This parameter determines the amount of straight signal fed to Effect 2.

Detune (-99 to +99 cents)

Adjusts the selected link's tuning in cents, from -99 (transposed down 99/100 of a semitone) to +99 (transposed up 99/100 of a semitone). Slight amounts of detuning add chorusing and flanging effects (these effects can also be created by the on-board signal processing).

Xpose (-48 to +48 semitones)

Transposes the selected link's frequency in semitone steps, from -48 (transposed down four octaves) to +48 (transposed up four octaves).

Delay (000 to 990 ms in 10 ms increments)

The selected link will not start playing until the specified delay time has elapsed. This is useful for adding echo effects or creating sounds with multiple attacks.

4.3h4 Links Page 4

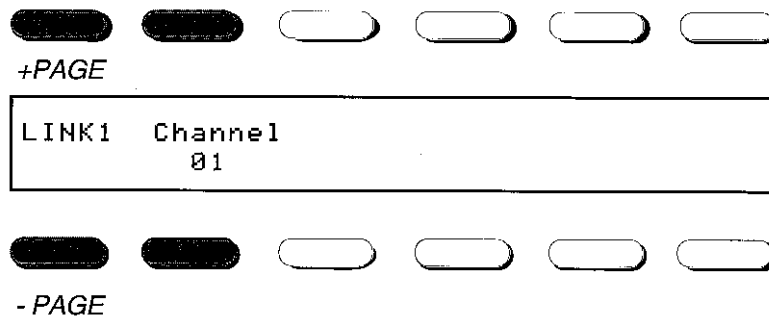

Channel

Selects the MIDI channel (1 through 16) that the selected link (LINK1 in our example) transmits data

Chapter 5: Programming the On-Board Signal Processors

5.1 ABOUT DPM SIGNAL PROCESSING

The DPM offers sophisticated signal processing options that modify the basic patch program sounds, with results comparable to what can be obtained from outboard rack-mount devices. Signal processing modules include time-based effects (reverb, gated reverb, chorus, flanging, stereo delay), equalization, distortion, and an “exciter” that enhances sounds through a combination of phase changes and equalization. Signal processing setups need not be global; each program has its own associated signal processing parameters, and can be processed in a unique way.

5.1a Effects Structure

There are two independent effects units (Effect 1 and Effect 2). Each one can include one or two effects (called Single or Dual effects mode respectively), giving a possible total of up to four signal processing “modules” in all. The signal processing options (in addition to Bypass, where the effect module has no effect) are listed below, along with a brief description of each function.

Single effects mode options

- **Reverb** (produces the type of ambience characteristic of rooms and concert halls)
- **Delay** (produces echo unit effects, where a sound is repeated at progressively-lower levels)
- **Chorus** (simulates instruments playing *en ensemble*, giving a thicker, richer sound)
- **EQ** (equalization; a type of tone control used to alter frequency response)
- **Gate** (“gated” reverb has a more abrupt decay than standard reverb)
- **Distortion** (produces a fuzz effect that can create a dirtier, grittier sound)
- **Exciter** (provides equalization and phase change to enhance a signal’s “presence”)

Dual effects mode options (each includes a pair of the above single effects)

<i>Chorus/Gate</i>	<i>Chorus/Distortion</i>	<i>Chorus/Exciter</i>	<i>Delay/EQ</i>
<i>Delay /Distortion</i>	<i>Delay/Distortion</i>	<i>Delay/Reverb</i>	<i>Delay/Exciter</i>
<i>Distortion/EQ</i>	<i>EQ/Gate</i>	<i>EQ/Distortion</i>	<i>EQ/Reverb</i>
<i>Distortion/Reverb</i>	<i>Distortion/Exciter</i>	<i>Distortion/Delay</i>	<i>Distortion/Chorus</i>
<i>EQ/Chorus</i>	<i>Exciter/Chorus</i>	<i>Exciter/Reverb</i>	<i>Exciter/Delay</i>
<i>Exciter/Distortion</i>	<i>Exciter/Gate</i>	<i>Gate/Exciter</i>	<i>Gate/Chorus</i>
<i>Reverb/Chorus</i>	<i>Chorus/Reverb</i>	<i>Chorus/Delay</i>	<i>Chorus/EQ</i>
<i>Reverb/Exciter</i>	<i>Reverb/Delay</i>	<i>Reverb/EQ</i>	<i>Reverb/Distortion</i>

Note: The Chorus module can also provide *flanging* (a “swooping,” jet airplane-like sound) with appropriate parameter settings, described later. Also remember that the various synthesizer voice modules offer many signal processing options—delay for one or more links in a Combi patch, tremolo by modulating a DCA with an LFO, etc.

Important: Some combinations of effects, mostly those involving reverb, are not available because of the huge amounts of computer processing they would require.

Example: Effect 1 could be assigned to Reverb/EQ and Effect 2 to Delay/Chorus, but Effect 2 could not be set to Reverb/Chorus. The display will advise you if a particular combination of effects is not possible.

5.1b The Differences Between Effect 1 and Effect 2

If Effect 1 includes a pair of effects (such as Reverb/Chorus), these can be configured in three different ways: series, parallel, or dual.

The following figure shows the *series* connection. The stereo audio outputs feed Effect 1's first stage, which then feeds the second stage. The second stage provides the master stereo outputs and provides a master level parameter.

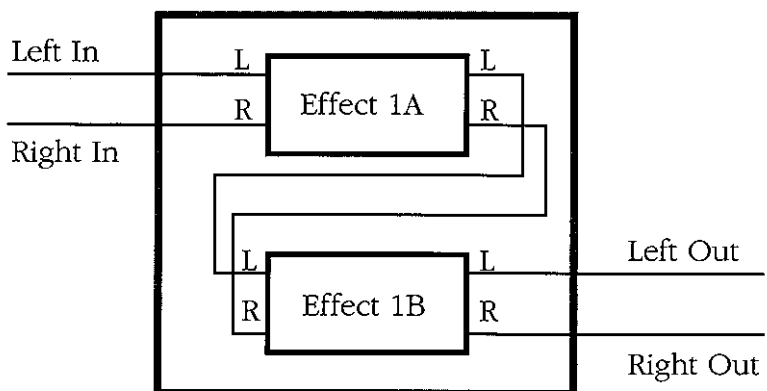

The *parallel* connection routes the stereo audio outputs to both stages simultaneously; their outputs are then mixed together to provide the master stereo outputs. Each output has an associated level parameter.

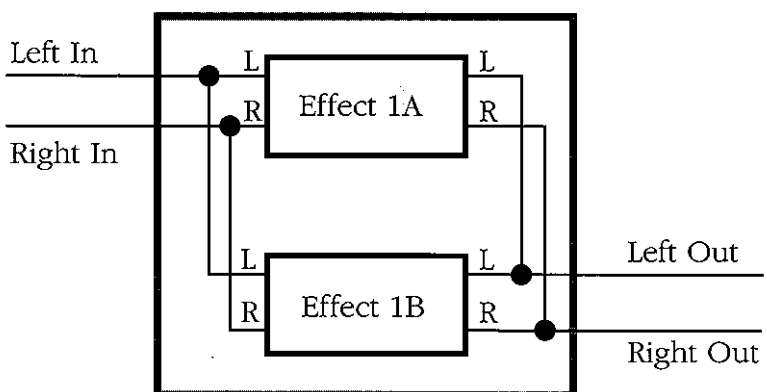

The *dual* connection feeds the left channel to one stage and the right channel to the other stage. Each effect synthesizes a stereo output, which are mixed together into a master stereo output. Each output has an associated level parameter.

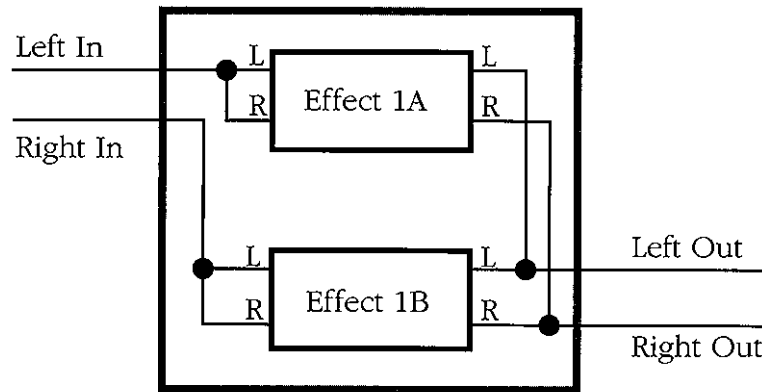

Effect 2 does not offer different configurations. If Effect 2 includes a pair of effects, these are always set up in series (like Effect 1 when it's set up in series). However, Effect 2 does include a send control that "sends" some or all of the pre-panned program output to Effect 2. *Example:* To add a trace of the exciter effect, set up Effect 2 as an exciter, then send a small amount of the program sound to Effect 2.

The following diagram shows how Effect 1 and 2 are configured. The diagram assumes that both Effect 1 and Effect 2 are set up as dual effects, yielding four effects in total. However, either or both could also be set up as single effects, or be bypassed if you don't want any effects at all. (Effect 1 could also use a parallel or dual connection.) Note how the send parameter determines how much signal goes to Effect 2.

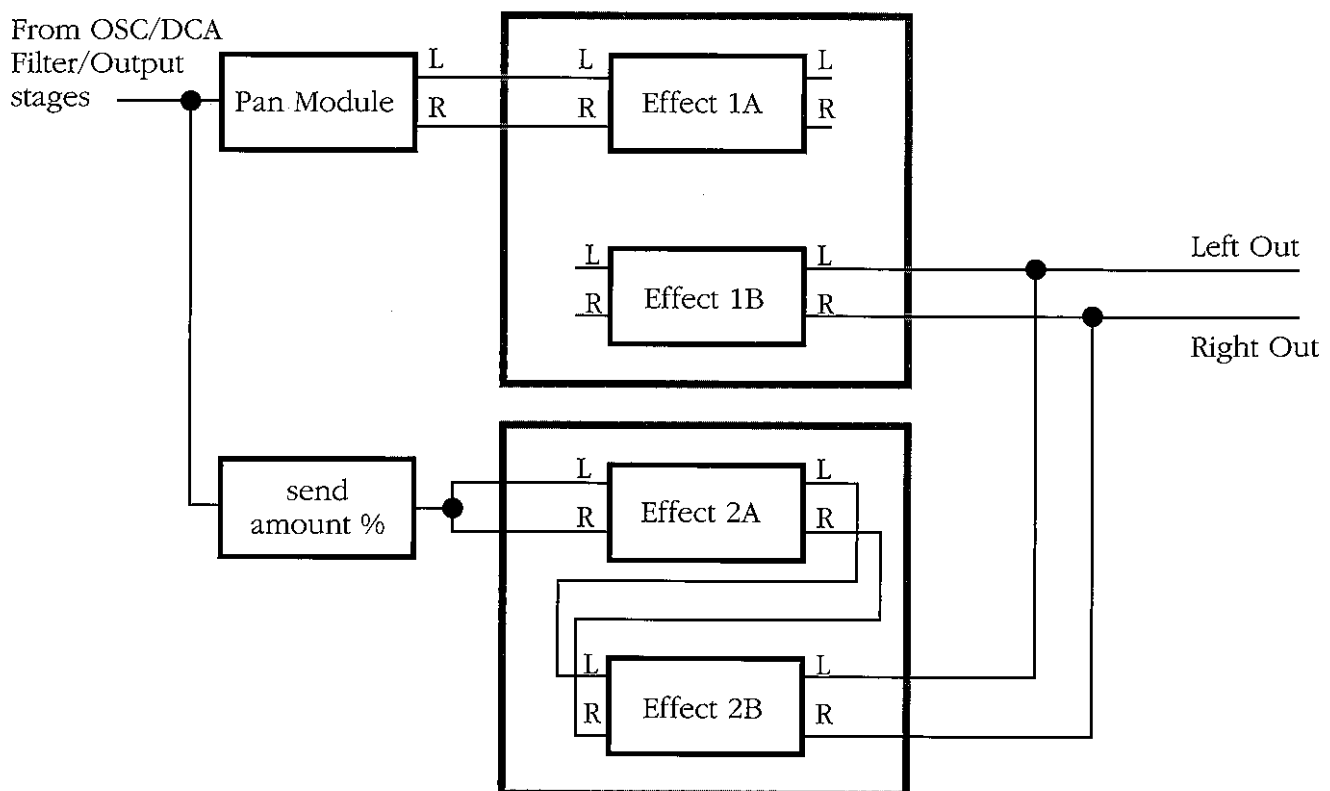

If this seems complicated, well, it can be if you want to use the signal processing options to their maximum potential. To get started, try working with single effects to hear how they affect the sound. Then try different combinations and modes to become familiar with the various possibilities.

5.2 SIGNAL PROCESSORS IN MULTI CONFIGURATIONS

Calling up a program calls up a particular set of signal processing parameters, identified by the same name as the program—but what happens in a MIDI Multi configuration, where you have multiple programs? The Multi will use one patch program's set of signal processing parameters, but *which* program's set depends on a variety of factors.

- **Base channel program parameters** The DPM, even in Multi mode where different programs respond to different channels, nonetheless uses MIDI *base channel* information. This is the channel that would be selected if the unit was in MIDI POLY mode (the base channel is the first parameter in the MIDI menu). If any program in a Multi is set to the base channel, then the signal processing effects parameters associated with that program will affect all programs that are part of the Multi.

- **Last individual program selected** If no program in a Multi is set to the base channel, then the DPM will use the parameters belonging to the program that was selected prior to entering Multi mode. *Example:* If you select Program 027, then switch over to a Multi and the Multi has no program assigned to the base channel, the effects parameters for Program 027 will affect all programs that are part of the Multi.

- **Program selected via MIDI program change commands** Sending a program change over the base channel to call up a different program will not only select that program, but also select the signal processing parameters associated with that program. This is particularly useful if you want to have the same patch program use different signal processing parameters at different times. Copy the patch program to two locations, set independent signal processing parameters for each, then call up the desired program and processing as needed.

Note: Sequences can also have an associated effect. This is covered in Chapter 6.

5.3 FX PARAMETER PROGRAMMING

Programming effects parameters follows a consistent procedure. The following is an overview; sections 5.3a - 5.3h describe the process in more detail.

1. Select the program with the effect whose parameters you want to modify.
2. Press the **Effect 1** Voice Edit button.
3. The first screen will show the effects that have been selected for the patch. You can change the effects assignment and effects configuration on this screen.
4. Pressing the *-Page* (or *+Page*) button takes you through screens that let you edit the parameters for the selected effects.
5. The final screen lets you set the output mix of the two effects. This affects the overall output only and does not vary the mix between straight and processed sounds, which is set on the parameter editing screens.

5.3a Programming Signal Processing Parameters

Programming effects parameters for individual programs requires certain common procedures.

1. Make sure that *-FxSelect-* (Global menu) is set to Program so that calling up a program calls up the associated effects patch (see section 2.6).
2. Select the program whose effects parameters you want to modify.
3. Press the **Effect 1** Voice Edit button to edit the first effect or **Effect 2** Voice Edit button to edit the second effect. The effects selection screen for Effect 1 looks similar to the following:

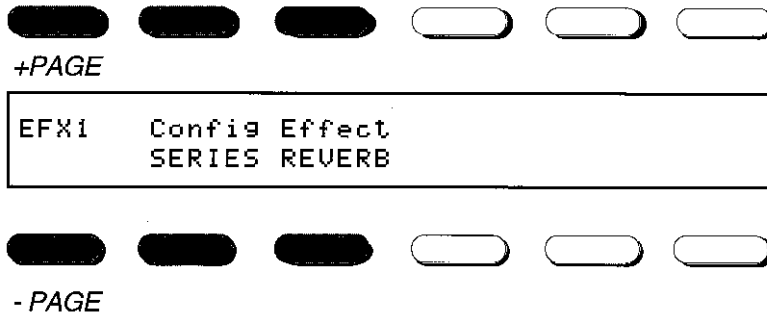

4. Pressing the *-Page* button (or the *+Page* button) goes through the effects. The parameter edit pages are described later.
5. To get to the output mix screen press the **Volume** Voice Edit button. A screen similar to the following will appear:

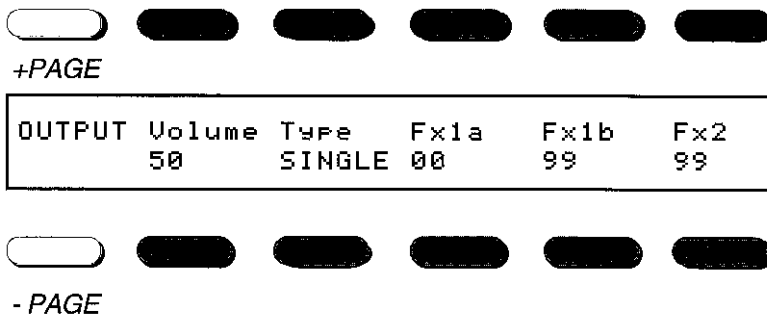

6. After programming the various parameters and setting the effects output mix, save the program. The effects parameters will be stored with the program. If you do not save the program and select a different program, your effects edits will be lost.

5.3b Reverb Parameter

You'll find that different types of reverb sound best with particular types of signals. For example, "smooth" reverb works well with percussive sounds, whereas "medium" reverb seems well-suited to piano sounds.

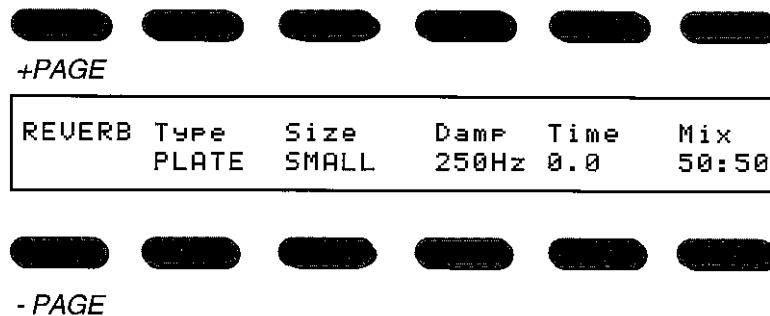

REVERB	Type	Size	Damp	Time	Mix
	PLATE	SMALL	250Hz	0.0	50:50

Type

Select among Plate, Room, and Hall. Each provides a different reverb characteristic.

Size

Select among small, medium, large, huge and smooth. This alters the apparent size of the reverberant space.

Damp

Determines the high-frequency "absorption" of the room by using a low-pass filter to simulate a more acoustically-"dead" environment. Select from cutoff frequencies of 250 Hz, 500 Hz, 1 kHz, 2 kHz, 4 kHz, 8 kHz, or OFF (full high-frequency response).

Time

Sets the length of the reverb "tail." Select from 0.0 to 8.0 seconds in 100 millisecond increments, and from 8 to 30 seconds in one second increments.

Mix

Adjusts the ratio between dry and effected (wet) signals, as well as DRY for all-dry and WET for all-wet signals. The mix value affects only the wet/dry balance within the effect; it is independent of the mix levels for Effect 1 and Effect 2 Fx1a, Fx1b and Fx2 parameters.

5.3c Delay Parameters

This is a stereo delay system with feedback. It's useful for slapback echoes, long echoes, and poly-rhythmic echo effects (try setting one delay time to 67% of the other's delay time).

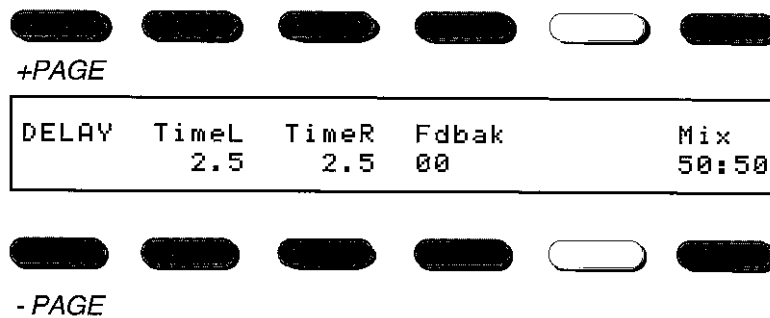

TimeL

Sets the left channel delay time, from 2.5 milliseconds to 250 milliseconds, in 2.5 millisecond increments.

TimeR

Sets the right channel delay time, from 2.5 milliseconds to 250 milliseconds, in 2.5 millisecond increments.

Fdbak (00 to 99)

Determines how much of the echo signal feeds back to the input for reechoing. Higher values give longer echo "tails."

Mix

Adjusts the ratio between dry and effected (wet) signals, as well as DRY for all-dry and WET for all-wet signals. The mix value affects only the wet/dry balance within the effect; it is independent of the mix levels for Effect 1 and Effect 2 Fx1a, Fx1b and Fx2 parameters.

5.3d Chorus Parameters

Stereo chorusing thickens up a sound by delaying the sound by a small amount (generally less than 25 milliseconds), changing the delayed sound's pitch periodically with LFO modulation, then mixing the delayed and straight signals together. The various phase cancellations and additions that occur as the delayed and straight signals interact produce chorusing. Also note that the chorus effect can be used for flanging, as described below.

With many synthesizers, the recommended way to chorus is layering two identical sounds together and slightly de-tune them. However, this cuts the available polyphony in half since two notes are layered on one key. Using chorusing signal processing lets you retain full polyphony (as does assigning the same sound to Wave1 and Wave2 in a voice, and slightly de-tuning them).

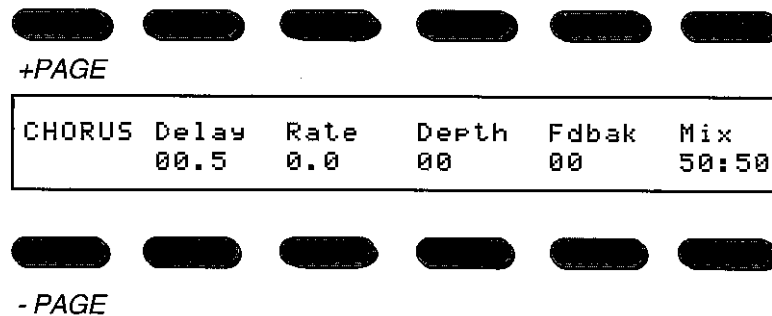

Delay (0.5 to 25.0 ms)

Sets the initial chorus delay time in 0.5 millisecond increments from 00.5 ms to 25.0 ms. Generally, the range of 12 ms to 25 ms is ideal for chorusing; 00.5 ms to 12 ms is a good range for flange effects.

Rate (0.0 Hz to 9.9 Hz)

Sets the periodic modulation rate from 0.0 Hz to 9.9 Hz, in 0.1 Hz increments. Use slower rates (e.g., 0.3 Hz) for flanging.

Depth (00 to 99)

Varies the modulation amount from 00 (no modulation) to 99 (maximum modulation). Flanging usually sounds best with maximum modulation, a short delay time, and a slow modulation rate.

Fdbak (00 to 99)

Determines how much of the chorused signal feeds back to the input; more feedback creates more intense sounds.

Mix

Adjusts the ratio between dry and effected (wet) signals, as well as DRY for all-dry and WET for all-wet signals. The most intense chorusing and flanging effects occur with a 50:50 mix of dry to wet. Tilting the ratio toward dry (e.g., >50:50) puts the chorus or flanging effect more in the background. The mix value affects only the wet/dry balance within the effect; it is independent of the mix levels for Effect 1 and Effect 2.

5.3e EQ Parameters

EQ alters a sound's frequency response. For example, boosting the lower frequencies gives a sound with more bass; boosting the higher frequencies gives a brighter sound.

The DPM's EQ is a two-channel, shelving type (so-called because the frequency response creates a "shelf" starting at the chosen frequency). The figure below shows a typical response curve available with the EQ.

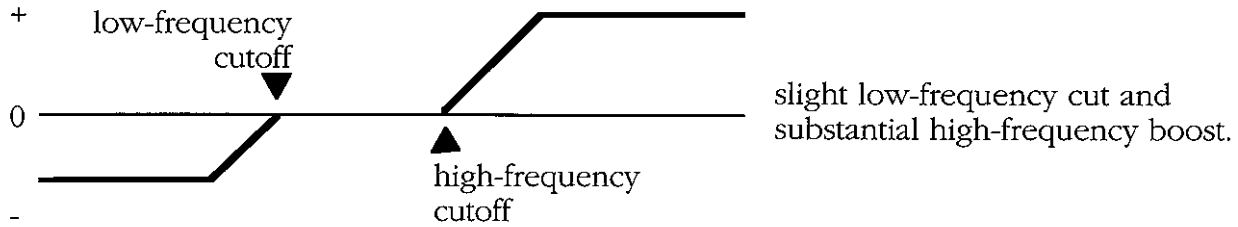

+PAGE

EQ	Lowq	Gain	Hiq	Gain	Mix
	125Hz	+00	125Hz	+00	50:50

-PAGE

Lowq

Low frequency cutoff. Select from 125 Hz, 250 Hz, 500 Hz, 1 kHz, 2 kHz, 4 kHz and 8 kHz.

Gain (-12 to +12)

Sets the amount of boost or cut affecting the low frequencies, in 1 dB increments, from -12 dB (maximum cut) to 00 (no affect) to +12 dB (maximum boost).

Hiq

High frequency cutoff. Select from 125 Hz, 250 Hz, 500 Hz, 1 kHz, 2 kHz, 4 kHz and 8 kHz.

Gain (-12 to +12)

Sets the amount of boost or cut affecting the low frequencies, in 1 dB increments, from -12 dB (maximum cut) to 00 (no affect) to +12 dB (maximum boost).

Mix

Adjusts the ratio between dry and effected (wet) signals, as well as DRY for all-dry and WET for all-wet signals. The mix value affects only the wet/dry balance within the effect; it is independent of the mix levels for Effect 1 and Effect 2 Fx1a, Fx1b and Fx2 parameters.

5.3f Gated Reverb

Gated reverb produces an effect which is similar to reverb, but has a sharper and more synthetic decay. It is frequently used with percussive signals to give more “punch” but is by no means limited to percussive sounds.

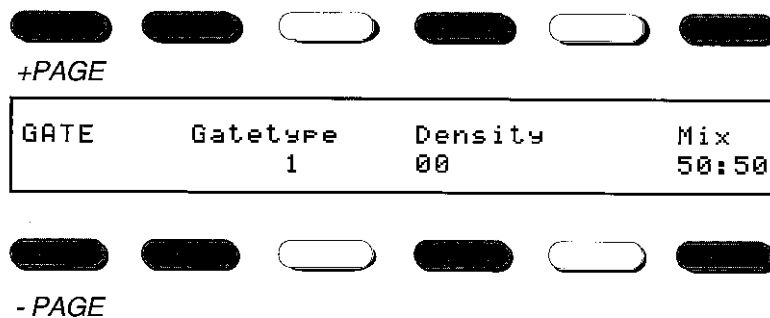

Gatetype

Chooses between three different types: Gate 1, Gate 2, and Gate 3.

Density (0 to 9)

Determines the reverb tail's envelope shape by altering the density of the early reflection patterns. Higher densities give a longer tail.

Mix

Adjusts the ratio between dry and effected (wet) signals, as well as DRY for all-dry and WET for all-wet signals. The mix value affects only the wet/dry balance within the effect; it is independent of the mix levels for Effect 1 and Effect 2 Fx1a, Fx1b and Fx2 parameters.

5.3g Distortion Parameters

Distortion is useful for creating fuzz guitar sounds or for adding a bit of “crunch” to otherwise clean sounds, such as organ. Note: The Distortion/EQ dual mode combination effect is very useful, as you can use EQ to remove some high frequencies for a “warmer” fuzz sound.

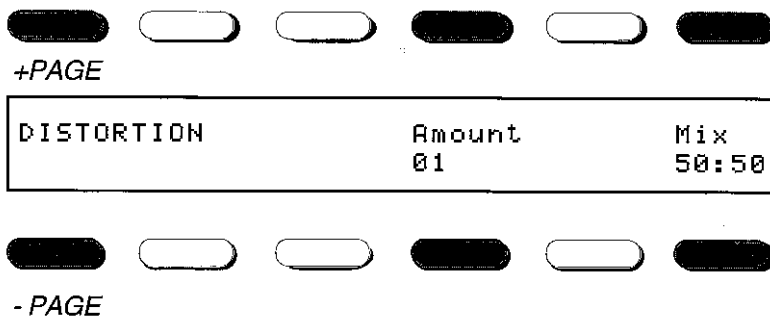

Amount (00 to 99)

Chooses the distortion intensity; higher values create more distortion.

Mix

Adjusts the ratio between dry and effected (wet) signals, as well as DRY for all-dry and WET for all-wet signals. The mix value affects only the wet/dry balance within the effect; it is independent of the mix levels for Effect 1 and Effect 2 Fx1a, Fx1b and Fx2 parameters.

5.3h Exciter Parameters

The exciter can increase a sound's presence and/or depth. It resembles equalization but makes use of phase changes and resonant frequency shifting.

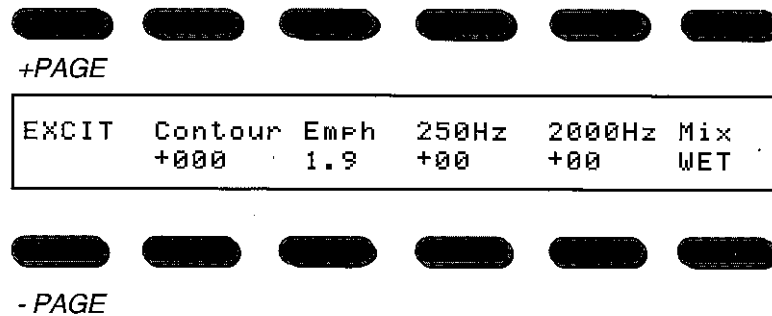

Contour (-100 to +100)

Determines the phase and amount of the exciter effect.

Emph

Sets the frequency where the exciter is most prominent, from 1.9 kHz to 19.2 kHz.

250Hz (-12 to +12)

Boosts or cuts the 250 Hz frequency range to add depth or remove boominess, respectively.

2000Hz (-12 to +12)

Boost or cuts the 2 kHz frequency range to add or remove presence, respectively.

Mix

Adjusts the ratio between dry and effected (wet) signals, as well as DRY for all-dry and WET for all-wet signals. The mix value affects only the wet/dry balance within the effect; it is independent of the mix levels for Effect 1 and Effect 2 Fx1a, Fx1b and Fx2 parameters.

5.4 COMBINATION EFFECTS OPTIONS

The combination effects use the same parameters as described in the previous sections. For example, Reverb/Chorus includes the same parameters as the individual Reverb and Chorus effects.

The order of effects can make a big difference in the overall sound. As always, experimentation is the key to learning these differences, but the following specific examples should help get you started.

Distortion/Reverb and Reverb/Distortion

Placing distortion before reverb gives a clean reverb effect superimposed on a distorted sound. Placing distortion after reverb distorts the reverb signal, giving a "dirty" reverb effect.

Delay/Chorus and Chorus/Delay

Placing delay before chorus means that chorus will produce an overall modulation of the delayed sound. Placing chorus before delay produces a more diffused sound as the echoes repeat different parts of the chorused signal.

Distortion/EQ and EQ/Distortion

With distortion before EQ, the EQ shapes the distorted sound. Placing EQ prior to distortion changes the character of the distortion by emphasizing or de-emphasizing those frequencies to be distorted.

Reverb/EQ and EQ/Reverb

This is an example of a combination effect where the difference between the two options is not particularly noticeable; EQing reverb or reverberating EQ makes little practical difference.

Also remember that you can obtain combination effects by using individual effects for Effect 1 and Effect 2. One very useful combination is assigning both effects to reverb. Due to the extensive computing power required to produce reverb effects, there is a noticeable periodic variation on long reverb tails. Using two reverbs set for different reverb times and equivalent levels can produce a much smoother sound.

Chapter 6: Sequencing

6.1 BASIC OPERATION

The DPM includes a 9-track sequencer designed for efficient composing. Each track can play back polyphonically through its own internal sound, send polyphonic MIDI data out to other instruments, or both.

Even if you have a computer-based sequencer, the DPM's sequencer provides three major benefits:

- You can capture inspirations as soon as you turn on the DPM—you don't have to wait to boot up a computer.
- The DPM can sync to your main sequencer, thus adding up to nine more MIDI channels to your setup.
- Parts that use lots of aftertouch, pitch bend, modulation, etc., may overload your main sequencer and cause timing problems. These parts can be transferred to the DPM sequencer and played back while synchronized to the main sequencer, thus relieving the main sequencer of the burden of handling this data.

Storage The sequencer memory stores up to 50 sequences; however, the total number of events cannot exceed approximately 20,000.

Sequence structures An individual sequence can be treated as a complete composition. This approach is called *linear* recording, since events are recorded “in a line” from beginning to end. The DPM also allows for *modular* (or *drum-machine style*) sequencing, where individual sequences can be combined into a Song. *Example:* One sequence could be a verse, another a chorus, a third an instrumental break, and so on; a Song would play back each sequence consecutively, in the desired order. Up to 10 Songs can be stored that use any of the sequences in memory.

Resolution The resolution is 96 clocks per quarter note—accurate enough to reproduce your “feel.”

Editing options Most operations can affect entire tracks, portions of tracks, specific ranges of notes, etc. Furthermore, a “step edit/entry” mode lets you work on an individual note level if desired—it's like putting your sequence under a microscope.

Tracks Tracks are numbered 0-8. Track 0 is usually where a rhythm part is recorded.

Although instruments are assigned to tracks in a manner similar to Multi mode, these functions are completely different. It is not necessary to create a Multi patch to use the sequencer.

An improvement over the original DPM 3 is that per-track program changes can now be recorded, thus allowing a track's instrument to be changed at any time.

Looping The sequencer also allows for *looping*, where any track can play continuously by jumping back to the beginning after reaching the end. However, since each track can have a separate length, loops can be independent (loop four bars of drums, eight bars of bass, etc.).

“Tape transport” Basic operation is similar to using a tape recorder, with familiar Play, Record, Erase, Fast Forward, and Rewind controls. The main difference is that sequencer editing is far more precise and detailed than using a splicing block and razor blade.

6.2 OVERVIEW OF SEQUENCER BUTTON FUNCTIONS

Pressing a sequencer button calls up a particular set of functions, as described below.

- **Song button** For choosing an individual song.
- **Pattern button** For choosing an individual sequence.
- **Track button** Here is where you assign instruments, MIDI channels, volume levels, fx sends, and similar track-related parameters to individual tracks.
- **Edit button** Presents you with the option to edit Songs, Sequences, entire Tracks, or individual Track events (called *step editing*). After selecting the desired option, a second screen appears that displays the various editing operations.
- **Status button** This indicates general system parameters—clock source, tempo, whether loop is on or off, etc. The second page displays the “status” screen. The status screen, during sequence playback or record, informs you of the current bar and beat number, transport status (stop, play, record, etc.), the total number of bars in the sequence, and the sequence name.

When playing back a Song, the playback screen shows which sequence is playing, the number of bars in the sequence, the current bar and beat, tempo, and transport status. You cannot enter parameters on this screen; it's like a tape recorder's footage counter, only more comprehensive.

6.3 SEQUENCE/SONG SELECTION

You can select any of the 50 sequences or 10 songs. The 50 sequences are arranged as 5 Banks of 10 sequences and the songs as 1 Bank of 10 songs. First select the desired Bank, then the desired sequence or song. For example, to select a sequence:

1. Press the **Pattern** Sequencer button. The display shows something like:

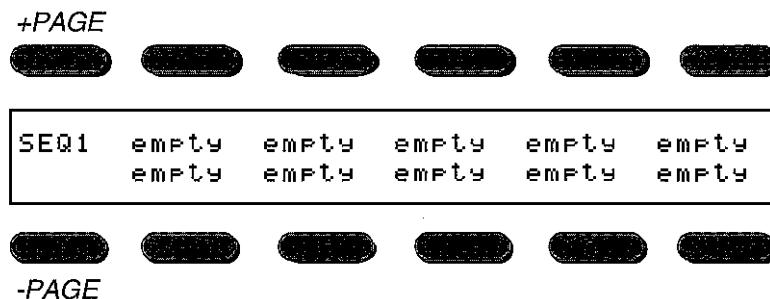

...unless there are sequences in memory, in which case their names will show instead of “empty.” In this example, the display's upper left corner indicates that Sequence Bank 1 is selected.

2. Press *+Page/-Page* buttons to scroll through the other banks (2, 3, 4, and 5).
3. After locating the desired bank, press the soft button associated with the sequence you want to play back or record into.
4. If you are playing the sequence or song and want to see the transport status, press the **Status** button. (You may need to press it twice to get to the transport status screen.)

Follow the same procedure to select a song. Except, press the **Song** button instead of the **Pattern** button. Since there is only one bank of songs you won't need to press either of the *Page* buttons. (Okay, so you already knew that.)

6.4 GETTING READY TO RECORD A SEQUENCE

Aside from a few basic setup considerations, recording a sequence does not involve any fixed procedure. You might record a track then edit it before moving on to recording another track, or record several tracks, then edit them. You might prefer linear recording or building songs out of numerous short sequences.

As a result, the following sections hopefully present the available sequencing options in an order that may correspond to the way you make music, but you might find it necessary to adopt your own sequencing protocols. Here's an overview of the material presented in this chapter:

- **Sequencer system setup (Section 6.5)** This is where you set the clock source, whether the metronome is on or off, whether loop mode is enabled, and so on. You will generally set these parameters before recording, but you may also change them during the recording process.
- **Sequence edit functions (Section 6.6)** Before recording into a sequence, you must first create it, as described in this section. Other sequence-level operations described here include deleting and copying sequences, clearing all sequences and songs in memory, and choosing a signal processing patch for the sequence.
- **Sequence track assignments (Section 6.7)** This is like an “electronic track sheet” where you assign sounds to tracks, determine whether a track will transmit/receive over MIDI and/or play internal sounds, set the track MIDI output channel if it transmits over MIDI, adjust the amount of effects send from each track to effects 2 of the chosen signal processing patch, and set track volume (including automated mixdown).
- **Recording a sequence (Section 6.8)** After setting up system parameters, creating a sequence (or copying a sequence from another location), and doing track assignments, it's time to record. This covers basic recording operations such as how to interpret the sequencer status screen and how to use the “transport” controls (play, record, rewind, etc.)
- **Track edit functions (Section 6.9)** You've recorded one or more tracks, so maybe you want to do some editing. This section includes information on erasing, copying, transposing, scaling velocity, quantizing, inserting, deleting, merging, and time-shifting; most of these operations can affect just a portion of a track, such as only a certain range of notes, events that occur over a certain range of measures, only certain controllers, etc.
- **Step recording/editing (section 6.10)** If you need even more detailed editing than is possible with the standard track edit functions, step editing lets you edit down to individual notes if desired. Step editing can also be integrated with the recording process at any time, so you can alternate between step recording/editing and conventional recording/editing.
- **Constructing a song (Section 6.11)** Now that you've perfected some sequences, here's how to string them together into songs. Options include naming, clearing, building a song, and editing song steps.

6.5 SEQUENCER SYSTEM SETUP (CONTROL SCREEN)

The Control screen (accessed by pressing the **Status** Sequencer button) allows for general system setup, either before recording a sequence or if you want to change the parameter (such as the metronome's rhythm) during the recording process.

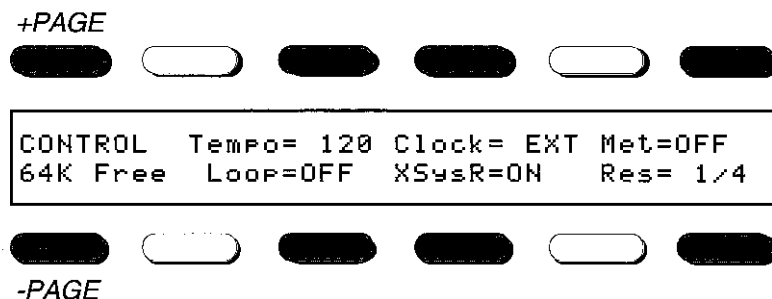

Tempo

The range extends from 40 To 250 BPM (beats per minute). This parameter is saved with a sequence or song. If clock is set to EXT, the tempo will be provided by the external MIDI clock source, not the internal tempo value.

Clock

Choose between INT (the DPM responds to its own clock at the specified tempo) or EXT (the DPM follows the external MIDI timing source if such signals are present at the DPM MIDI In).

Met

This is the DPM metronome. When ON, the DPM provides an audible click during sequence recording. The first beat of each bar is accented.

Free

This memory status shows the amount of memory available for recording. This cannot be adjusted and is a status display only.

Loop

When ON, tracks will jump back to their beginnings after playing through their designated lengths. Each track can loop independently. With loop OFF, tracks play through to their ends, then stop.

XSysR

If Clock= INT and XSysR= ON, the DPM will respond to MIDI stop, start, and continue commands present at the MIDI In port but follow its internal clock. If Clock= EXT and XSysR= ON, the DPM will respond to the above commands *and* external MIDI timing clocks. If XSysR= OFF, the DPM will not respond to stop, start, or continue commands, but if Clock= EXT, the DPM will respond to MIDI timing clocks.

Res

Selects either quarter (1/4), eighth (1/8), or sixteenth (1/16) notes as the metronome's rhythmic value.

6.6 SEQUENCE EDIT FUNCTIONS

1. Select the sequence as described in section 6.3; this is the sequence to be edited.
2. Press the **Edit** Sequencer button, then press the *Seqs* soft button. The display shows:

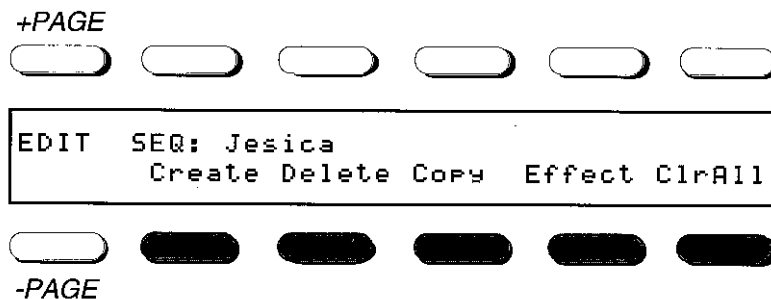

3. This is the main edit screen. The top line shows the sequence name (or “empty” if the sequence contains no data).
4. Press the desired editing function soft button: *Create*, *Delete*, *Copy*, *Effect*, or *ClrAll*. The following sections describe the screens and options that appear when you select one of these soft buttons. Whatever operation you select will affect whatever sequence you selected.

6.6a Create a Sequence

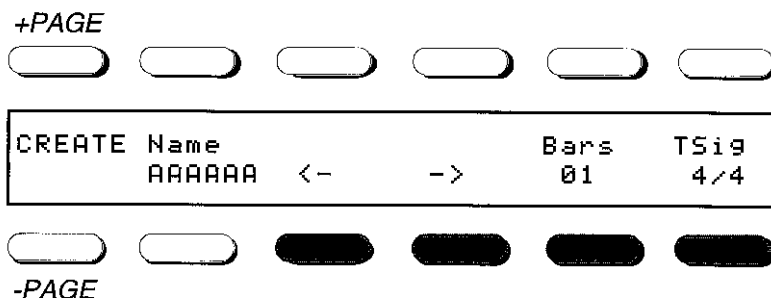

1. From the main edit screen, press the *Create* soft button.
2. Use the soft buttons below <- and -> to move the cursor to a new character and use the data slider or data wheel (DPM 4) to change the character.
3. Press the soft button above Bars= 01 (our example) to select the number of bars for the first track.
4. Press the soft button below TSig= 4/4 (our example) to select a time signature between 1/4 and 32/4
5. Press the **Enter** button.
6. You now need to tell the DPM where you are going to store this sequence (notice how the DPM keeps flashing “*C*” at you). Do this by selecting the sequence bank, Seq1 through Seq5, and pressing the soft button associated with the destination. Once a destination is selected you will see the name change to the sequence name that you just created.

6.6b Delete a Sequence

Deleting a sequence removes all data from the sequence and renames it as empty.

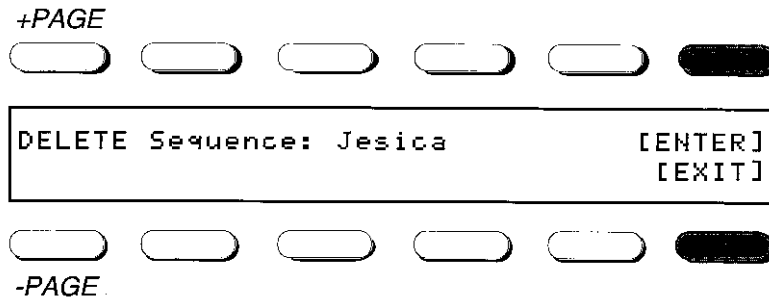

1. Before entering this screen you must select the sequence to be deleted. The name displayed is information and cannot be changed from this screen.
2. If everything is okay (i.e., the sequence name shown is the one you want to delete) press the **Enter** button. Otherwise, press the **Exit** button.

6.6c Copy a Sequence

Copying a sequence duplicates the contents of the currently selected sequence and places this duplicate data in a destination sequence you select. The source sequence is unaltered. This is very handy if you have a basic rhythm track and want to generate variations; copy the basic track to other sequences, then overdub additional parts.

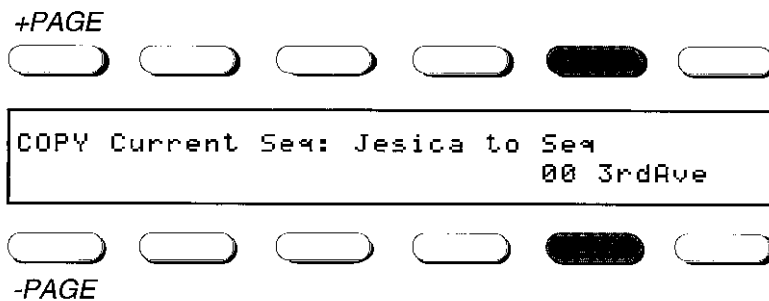

1. Before entering this screen you must select the sequence to be copied. The name displayed is information and cannot be changed from this screen.
2. If everything is okay (i.e., the sequence name shown is the one you want to copy) press the **Enter** button. Otherwise, press the **Exit** button.

6.6d Choose a Sequence Effect

You can assign any of the effects used with individual patch programs to the current sequence; all tracks will be processed by this effect, providing that FxSelect mode in the Global menu is set to either *Sequence* or *Auto*. Each sequencer track also has an effects send parameter similar to the one found on the voice edit output page. This option is described in section 6.7d.

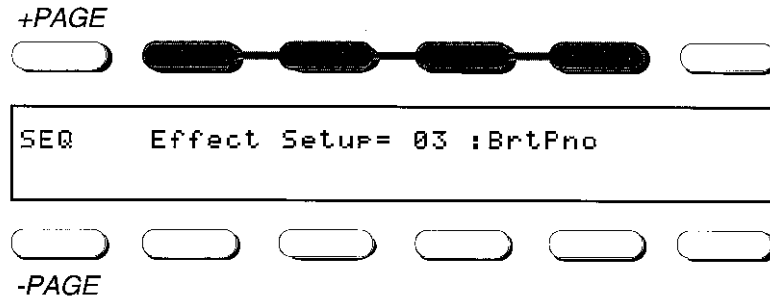

1. Press any of the soft button shown, then select the desired effect. The display will show the program number and effect name.
2. Press the **Enter** button and the effect will be assigned to the sequence.

6.6e Clear all Sequences

This deletes all Sequences and Songs from memory.

Warning: *This operation cannot be undone!*

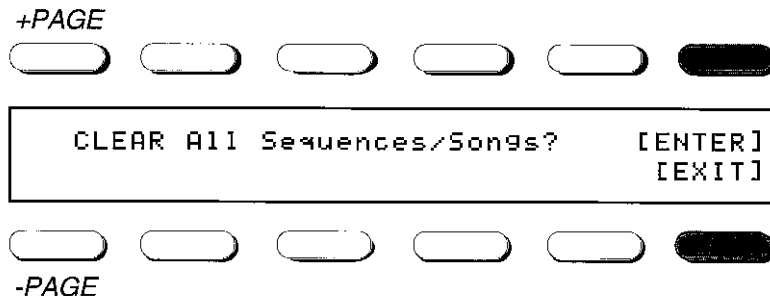

1. If you are sure you want to clear all the sequences and songs in memory, press the **Enter** button. Pressing any other button will abort this operation.

6.7 SEQUENCE TRACK ASSIGNMENTS

1. Make sure the current sequence is selected.
2. Press the **Track** Sequencer button. There are five track assignment screens:
 - **Track** Assigns programs to tracks and selects the current track.
 - **Configuration** Chooses how data is transmitted and received over MIDI, as well as whether or not the sequencer plays the internal programs.
 - **MIDIOut** Selects the channel over which a track will transmit data to other MIDI devices.
 - **FX2** Determines the amount of track signal sent to the effects 2 effects bus (see Chapter 5 on signal processing).

- **Volume** Determines volume of internal programs, and sends volume (controller 7 data) out over MIDI.

The following describes each screens operation. All assignments are retained when the sequence is saved.

Note: On all the Track Assignment screens the **Enter** and **Exit** buttons (you know, the ones to the right of the display), act as INC (Enter) and DEC (Exit) buttons.

6.7a Assign Program to Track

The track program assignment page shows which programs are assigned to which tracks. In the example below, all tracks have instruments assigned to them. An asterisk indicates the currently selected track (Vox 3 in our example), also, the program number is shown (042 in our example). The currently selected track can be played from the DPM keyboard; it is also the track into which recording will occur, or which will be initially selected for editing.

To assign a program, and select the current track, press the associated soft button, then select the desired program using any of the normal parameter editing methods.

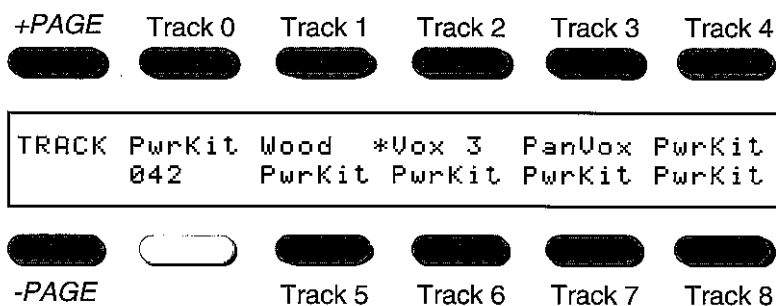

6.7b Track Configuration

Configuration determines whether a track will:

- Play the assigned internal programs only (INT)
- Transmit track data to MIDI Out but not play the internal program (EXT)
- Play the assigned internal programs and transmit data to MIDI Out (ALL)
- Transmit track data to MIDI Out but not play the internal program, and receive MIDI data from the MIDI In port (XMIDI).

The data an XMIDI track receives on depends on the MIDI menu mode assignment. If *Omni*, the track will receive data on any MIDI channel. If *Poly*, the track will receive data only on the DPM's assigned base channel. If *Multi*, the Multi assignment overrides the sequencer track program assignments and configuration.

Note: If a selected track doesn't seem to play, make sure that **INT** or **ALL** is selected.

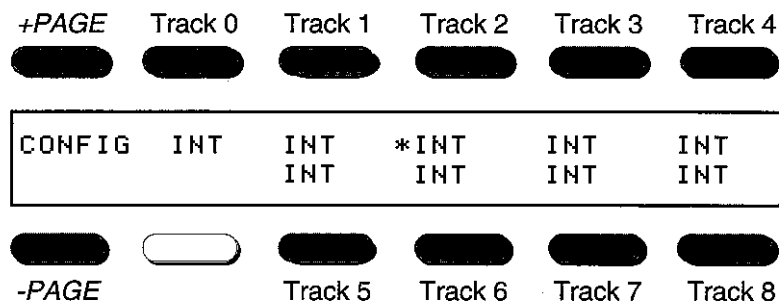

6.7c Track MIDI Output Assignment

This sets the output MIDI channel over which a track will transmit data in the EXT, ALL, and XMIDI configurations. Press the soft button associated with the desired track, then select the MIDI output channel.

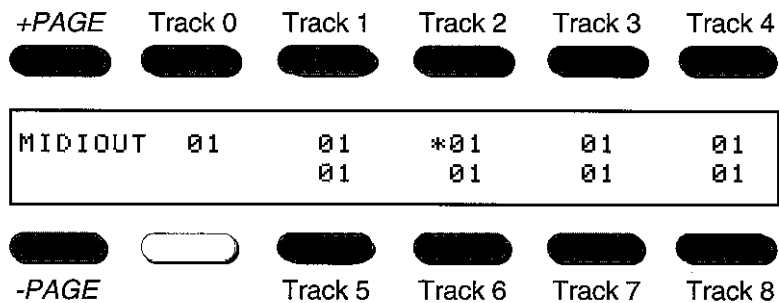

6.7d FX2 Send Assign

Just as each program can send a portion of its signal to the effects 2 send bus, so can each sequencer track (See Chapter 5 on signal processing for more information). Drum kits will use the kit's FX2 send amount; the display shows KIT for that track. For other tracks, press the associated soft button and select the desired amount of effects send.

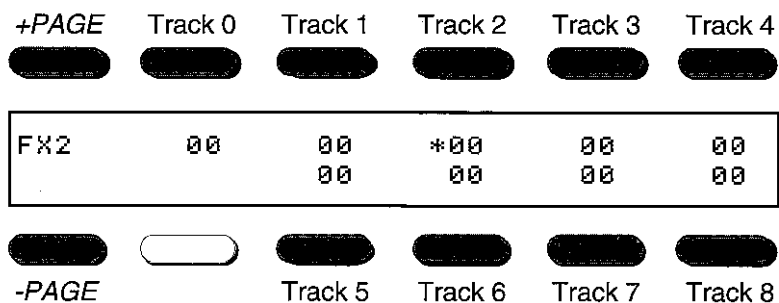

6.7e Set Track Volume/Automated Mixdown

This function sets the value of volume data transmitted over MIDI and the relative mix of the internal programs. The currently selected track is indicated with an asterisk. To change the track volume or transmit volume data over MIDI, press the track's associated soft button and select the volume data.

Clicking a selected track's soft button mutes the output; the track display shows MUTE. For automated

mixdown, adjust volume while the track is recording. Your fader movements will be recorded into the sequence.

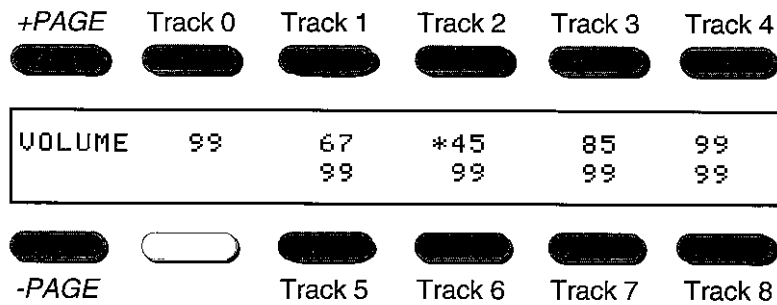

6.8 RECORDING A SEQUENCE

Once you have created and selected a sequence and assigned track parameters, it's time to record.

1. Press the **Track** Sequencer button and check the program assignment to make sure you have selected the proper track for recording (as indicated by * to the left of the track program).
2. Press the transport **Record** button. The display shows:

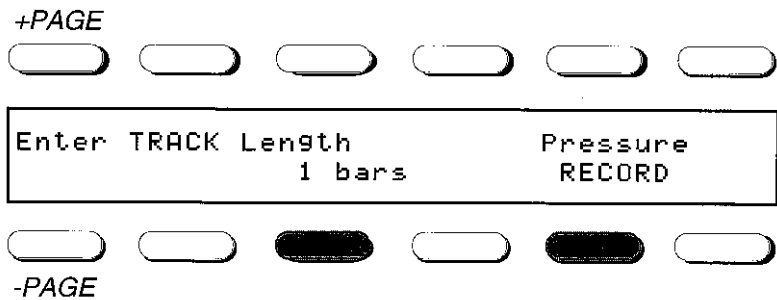

3. Press the *Length* soft button and select a length from 1 to 999 bars.
4. Press the *Pressure* soft button and select whether to RECORD or FILTER pressure (aftertouch) data.
5. Press the **Enter** button. The sequencer immediately jumps to the status screen, which you can also access at any time by pressing the **Status** button until the display shows something like:

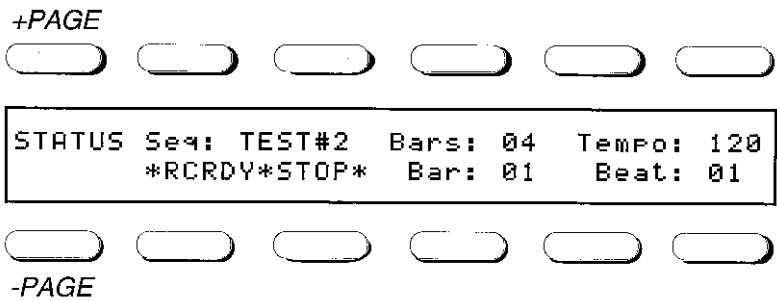

This is the screen that you will most likely want to watch while recording, playing back, or erasing. The transport status indicates whether the sequence is recording, playing back, ready to record, ready to erase, etc. The bar and beat numbers change as the sequence plays to show exactly where you are in the song.

6.8a Transport Controls: Rewind, Play, Fast Forward, Stop, Pause

The lower row of Sequencer buttons simulate a standard tape transport and are active when playing back, recording, or erasing. Their icons represent these functions:

● **Erase** This will be discussed later under sequence recording.

○ **Record** This will be discussed later under sequence recording.

<< **Rewind** Press once to back up one measure, or press and hold to back up one measure at a time for as long as the button is held down. The sequencer mutes during Rewind.

> **Play** Plays back recorded data. In Record Ready or Erase Ready mode, pressing Play also changes Record Ready to Record and Erase Ready to Erase.

>> **Fast Forward** Press once to go forward one measure, or press and hold to go forward one measure at a time for as long as the button is held down. The sequencer is muted during Fast Forward.

□ **Stop** Stops the sequencer.

|| **Pause** Pauses the sequencer. You must press Pause again to exit the paused state. Pause is also used in step editing, described in section 6.10.

Note: Rewind, play, fast forward, stop, and pause function whether a song or sequence is selected. Erase and record pertain only to sequences.

What happens when you release the Fast Forward or Rewind button depends on which mode was selected prior to pushing Fast Forward or Rewind.

Sequencer Mode Upon releasing Fast Forward or Rewind:

Playback Playback resumes

Recording Recording resumes

Paused Sequencer remains paused

Erase Playback resumes, but Erase went into Erase Ready mode as soon as you pressed Fast Forward or Rewind

Erase/Record Playback resumes, but Erase went into Erase Ready mode and Record went into Record Ready mode as soon as you pressed Fast Forward or Rewind

6.8b Recording, Erasing, and Overdubbing Functions

○ Record

This enables and disables the recording process. To record:

1. Make sure you have selected the correct Track to be recorded (section 6.8).
2. If the status screen is not showing, press the **Status** Sequencer button to select the status screen.
3. Press the **Record** Sequencer button. If the track is empty, you will be asked to specify a track length (section 6.8).
4. The transport status shows *RCRDY*STOP* (record ready–stopped).
5. Press the **Play** Sequencer button. The sequencer provides a 4 beat counter and the transport status changes to *RECRD*PLAY (recording), indicating the DPM is ready to record.
6. Recording will continue until you press the **Stop** Sequencer button. If Loop is ON (control screen, section 6.5), the sequence will jump back to the beginning after reaching the end. This allows you to record multiple passes. *Example:* Suppose you're recording a drum part. You could record the kick drum on the first pass, snare on the second, and so on.

You can return to **record ready mode** at any time by pressing the **Record** button. This lets you practice a part without recording it. When you're ready to record again, press **Play**, and the transport status changes from *RCRDY*STOP* to *RECRD*PLAY*.

Note: Recording is always in an overdub, sound-on-sound mode where new data is recorded without erasing old data. The next section describes how to record over unwanted data.

● Erase

This is used mainly for “spot erasure” of bad notes. The Edit Track menu offers general erase functions, such as erasing all notes or data within a certain number of bars.

To erase data:

1. Press the **Erase** Sequencer button. The transport status shows *ERRDY* *STOP* (erase ready–stopped).
2. Press the **Play** button. The sequencer provides a 4 beat counter.
3. Press **Erase** when you want to begin erasing data. The display changes to *ERASE* *PLAY*. If you want to erase starting from the first beat of the sequence, press Erase during the 4 beat counter.
4. Press **Erase** again when you want to stop erasing data. The display changes to *ERRDY* *STOP*. You can toggle back and forth between erase ready and erase as needed.

● ○ Erase + Record

This lets you record new data over old data, and requires using both the Erase and Record buttons.

1. With the desired track selected, press the **Erase** button. The transport status shows *ERRDY* *STOP* (erase ready–stopped).
2. Press the **Record** button to place the transport in the record ready mode. The transport will show *ERRDY*RCRDY*STOP*.

3. Press the **Play** button. The sequencer provides a 4 beat counter. Transport shows *ERRDY*RCDY*PLAY*
4. Press **Erase** or **Record** when you want to begin recording over the old data. The display changes from *ERRDY*RCDY*PLAY* to *ERASE*RECRD*PLAY*. To record starting from the first beat of the sequence, press either **Erase** or **Record** during the 4 beat counter. As with Erase and Record, you can toggle back and forth between Erase/Record Ready and Erase/Record as needed by pressing either the **Erase** or **Record** button.

Note: If Loop is ON, erase and record will revert to erase ready and record ready after the sequence has played through its entire length in order to prevent accidental erasure of data you want to keep.

6.9 TRACK EDIT FUNCTIONS

Once a track has been recorded, there are multiple edit functions. These can affect an entire track, only certain portions of a track, only notes that fall within a certain pitch range, etc.

- Erase specified data
 - Copy
 - Transpose pitch
 - Scale note velocities
 - Quantize (correct note timing to the nearest specified rhythmic value)
 - Insert data into a track
 - Delete all data in a particular range of measures
 - Merge data from one track to another
 - Slide data forward or backward in time
1. Select the Track to be edited. If you forget to do this before entering the track edit menu, you can also select the track from this menu.
 2. Press the **Edit** Sequencer button. The display shows:

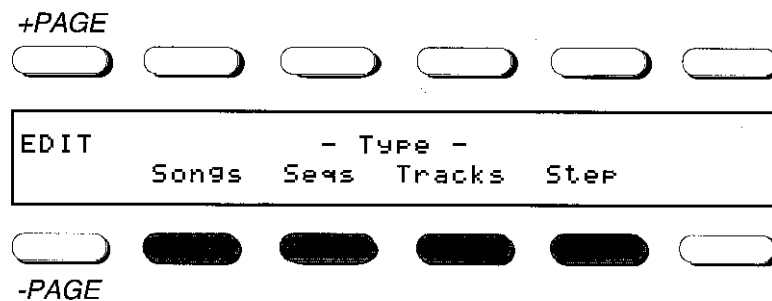

3. Press the *Tracks* soft button to access the Track editing functions. The display shows:

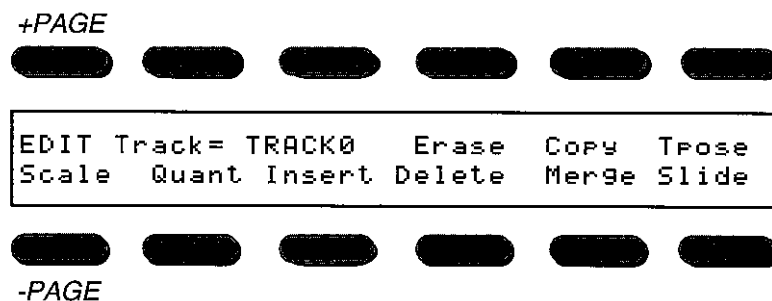

Track=

Selects the track number to be edited

The remaining functions on this screen are described in detail on the following pages.

- This is the main Track edit menu. After selecting the track (soft button above TRACK0 in our example), press the desired editing function soft button: *Erase*, *Copy*, *Transpose*, *Scale*, *Quantize*, *Insert*, *Delete*, *Merge*, or *Slide*. The following sections describe the screens and options that appear when you select one of these soft buttons. Whatever operation you select will affect whatever sequence you selected.

6.9a Erase Note and/or Controller Data

This function erases all or some note and/or controller data.

- The first screen specifies which notes or controllers are to be erased, and over what range of notes (optional).

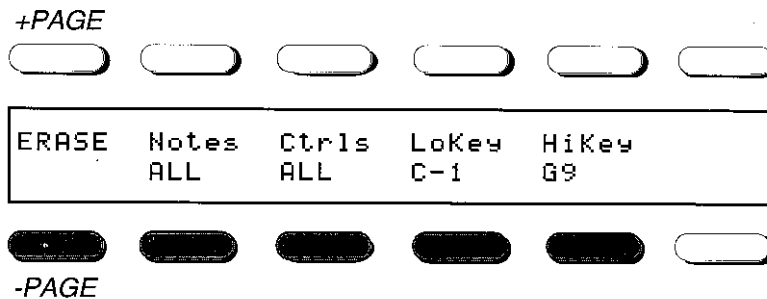

Notes

Select ALL to erase all notes, NONE to erase no notes, and RANGE to specify a range of notes to be erased with the Lo and Hi soft button.

Ctrl's

Select ALL to erase all controllers, NONE if you don't want to erase any controller information, or a specific controller to be erased: Pitch Bend, Pressure, Program Change, Mod Wheel, or Volume.

LoKey

Sets the lowest pitch of the note range to be erased when RANGE is the Notes option.

HiKey

Sets the highest pitch of the note range to be erased when RANGE is the Notes option.

-Page

Selects the second Erase screen.

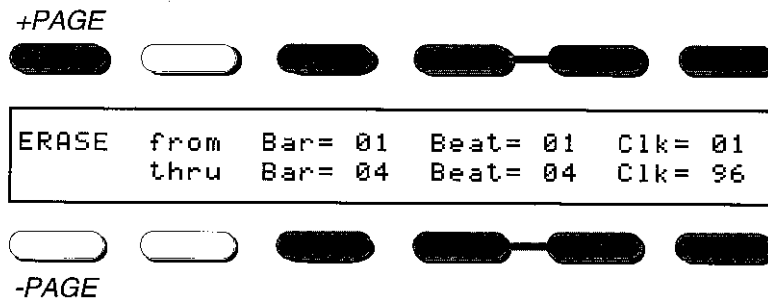

2. From this screen you can select the range of bars, beats, and clocks over which data will be erased.

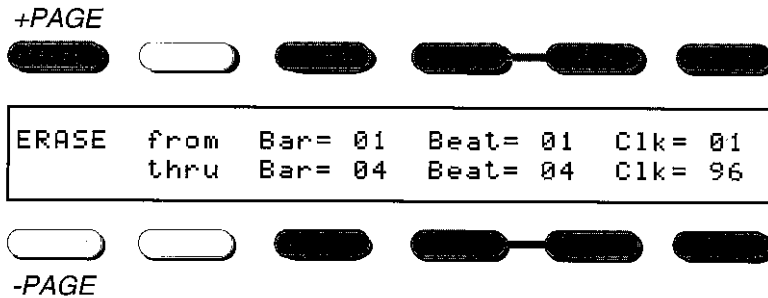

3. Press **Enter** button to confirm the erasure, or the *+Page* button (or any other non-soft button) to abort this operation.

6.9b Copy Note Data

This function copies track note data from one sequence to the same, or a different, sequence.

1. Select the *destination* sequence and track into which data will be copied.
2. Press the **Edit** button.
3. Press the *Track* soft button, then select the *destination* track if not previously selected.

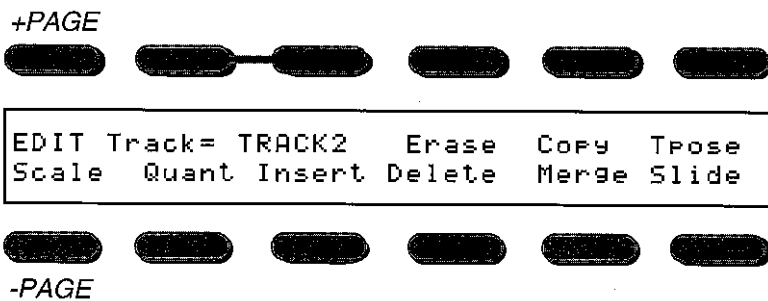

4. Press the *Copy* soft button. The display shows something like:

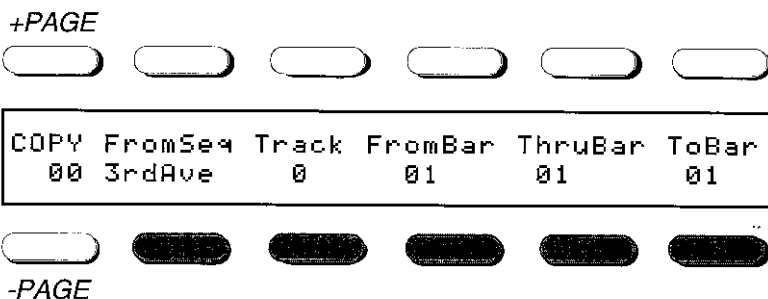

FromSeq

Selects the source sequence containing the track data you want to copy. (3rdAve in our example.)

Track

Selects the track in the source sequence containing the data you want to copy. (TRACK0 in our example.)

FromBar

Selects the bar you want to start at.

ThruBar

Selects the bar you want to copy through.

ToBar

Selects the copy point in the destination track.

-Page

Selects the second Copy screen.

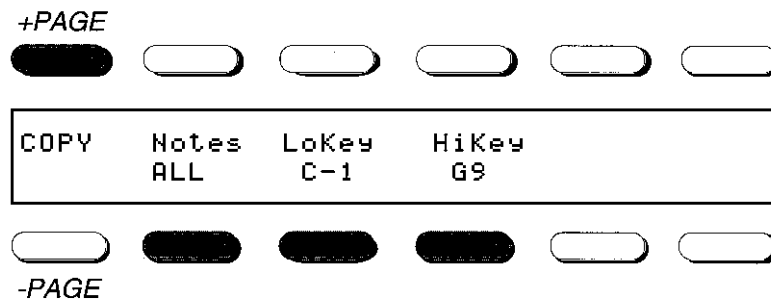

Notes

Select ALL to copy all notes or RANGE to specify a range of notes to be copied with the Lo and Hi soft buttons.

LoKey

Sets the lowest pitch of the note range you want to copy.

HiKey

Sets the highest pitch of the note range you want to copy.

Note: If the destination track already contains note data, it will be overwritten by the copied data.

5. **Warning! This operation cannot be undone.** Press the **Enter** button to confirm the copy, or the +Page button (or any other non-soft button) to abort this operation.

6.9c Transpose Note Data

This function transposes note data in semitone steps over a range of ± 2 octaves.

1. The first Transpose screen works similarly to the Copy screen described in section 6.9b.

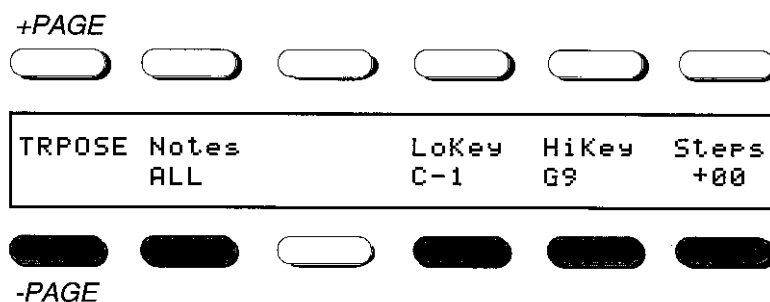

Notes, **LoKey** and **HiKey** work the same as described in section 6.9b.

Steps

Selects the transposition amount, from -24 to +24 semitones.

2. Press *-Page* to select the second Transpose screen.

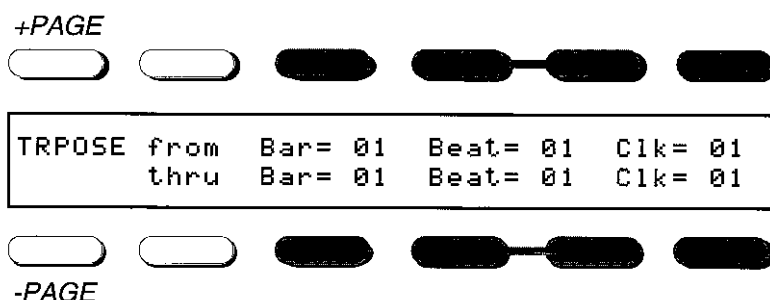

3. Select the range of bars, beats, and clocks over which data will be transposed.
4. Press the **Enter** button to confirm the transposition, or the *+Page* button (or any other non-soft button) to abort this operation.

6.9d Scale Note Velocities

This function multiplies velocity values by 1% to 255%.

1. The first Scale screen works similarly to the Copy screen described in section 6.9b.

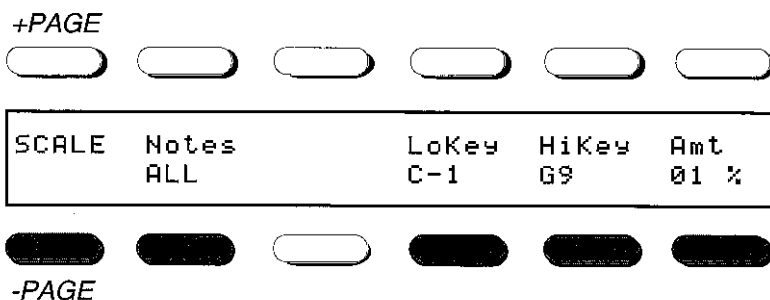

Notes, **Lokey**, and **HiKey** work as described in section 6.9b.

Amt

Selects the percentage of scaling to be performed.

2. Press the *-Page* soft button to select the second Scale screen.

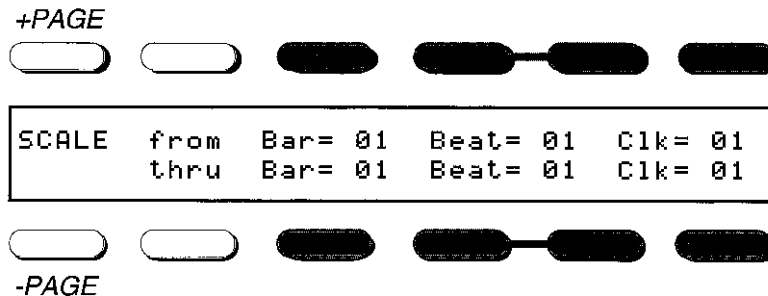

4. Select the range of bars, beats, and clocks over which data is to be scaled.

5. Press the **Enter** button to confirm scaling, or any other button to abort.

6.9e Quantize Note Data

This function shifts notes to the nearest specified rhythmic value. For example, if you quantize to 16th notes, the start of each quantized note will be shifted to the nearest 16th note.

1. The DPM offers two quantization modes, permanent where the quantize operation cannot be undone) and playback only where:

- The track is quantized only during playback but otherwise remains unedited, so you can audition the quantized part before committing to permanent quantization.
- The quantization value remains in effect for subsequent tracks you record.

After selecting the track and pressing the *Quant* soft button, the display shows:

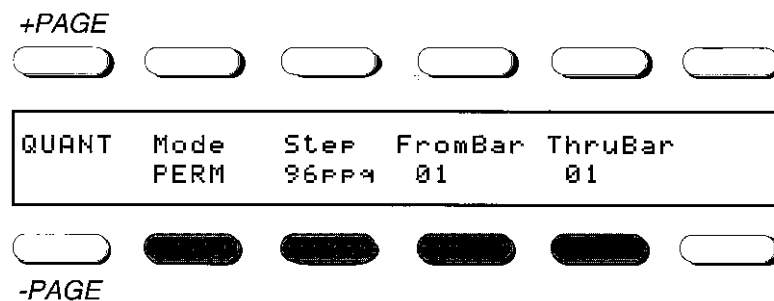

Mode

Selects either PERM or PLAY.

Step

Selects to quantization rhythmic value: 1/4, 1/4 triplet, 1/8, 1/8 triplet, 1/16, 1/16 triplet, 1/32, 1/32 triplet, and 96ppq (quantization off).

FromBar

Selects the bar that quantization will begin at.

ThruBar

Selects the bar at which quantization will stop.

4. Press the **Enter** button to confirm permanent quantization, or any other non-soft button to abort.

6.9f Insert Measure Data

This function inserts note data from part of a track into the same track, starting at a designated measure. The track is extended by the length of the inserted section. For example, assume four measures, A, B, C, and D. Inserting D before C creates a track that goes A, B, D, C, D.

1. The first Insert screen specifies the range to be inserted, and works similarly to the Copy screen described in section 6.9b.

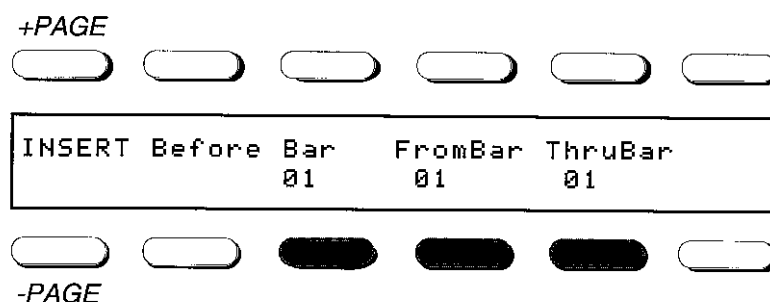

Before Bar

Selects the bar in the destination track that the insertion will come before.

FromBar

Selects the starting bar for insertion from the source track.

ThruBar

Selects the ending bar for insertion from the source track.

2. Press the **Enter** soft button to confirm the insertion or any non-soft button to abort.

6.9g Delete Measure Data

1. The first Delete screen specifies the measure range to be deleted, and works similarly to the Copy screen described in section 6.9b.

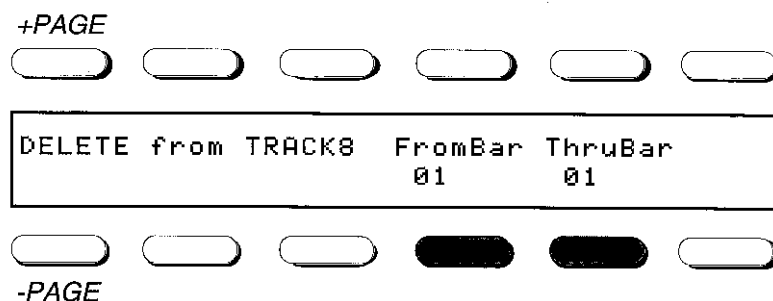

2. Select the range of bars to be deleted then press the **Enter** button to confirm the deletion, or any non-soft button to abort.

6.9h Merge Tracks

This function merges (mixes) all data from a specified track to the currently selected track. For example, record several different solos on one track. Delete all but the best sections of each track, then merge all the tracks together into one final, combined solo track.

1. Make sure the track into which you want to merge data is selected, then press the *Merge* soft button on the main edit screen. The display shows something like:

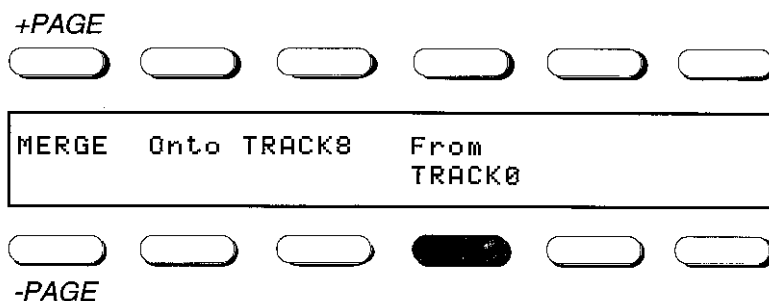

From

Selects the destination track number to be merged with the currently selected track.

Onto Track#

Shows the currently selected track number. The track number cannot be changed from this screen.

2. Press the **Enter** button to confirm insertion, or any non-soft button to abort.

6.9i Slide Data

This function slides all data (notes and controllers) forward or backward in time, by a specified number of clock pulses (up to ± 384 clock pulses).

1. Make sure the track whose data you want to shift is selected, then press the *Slide* soft button. The display shows something like:

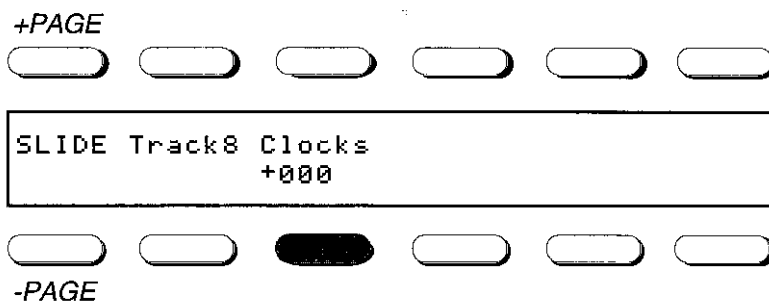

Clocks

Selects the shift in clock pulses. Negative values move events backward in time; positive values move events forward in time.

2. Press the **Enter** button to confirm the slide, or any non-soft button to abort.

6.10 STEP EDITING

The step edit function allows you to “step” through a sequence, a single clock at a time or a specific rhythmic value at a time, by pressing the > (Play) button. Each button press advances the sequence by the specified step value. During this process you can “punch in” or “punch out” to add or delete notes.

As you step through the sequence, the step edit screen shows the current location in bars, beats, and clocks (1 clock= 1/96th of a beat).

To enter step mode:

1. Select the Track to be edited (see section 6.7a).
2. Press the **Edit** Sequencer button.
3. Press the *Step* soft button. A display similar to the following appears:

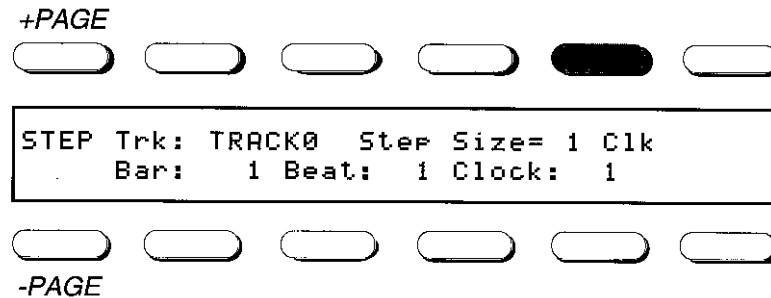

Step Size=

Sets the step size. Refer to the table below to relate the display number to conventional notation and to DPM clocks.

The rest of the screen shows current locations/settings for: track, bar, beat, and clock.

Step Size Table

Display	Note Value	# of Clocks
1/4	quarter note	96
1/4T	quarter note triplet	64
1/8	eighth note	48
1/8T	eighth note triplet	32
1/16	sixteenth note	24
1/16T	sixteenth note triplet	16
1/32	thirty-second note	12
1/32T	thirty-second note triplet	8
1 Clk	1/384th note	1

4. Select the desired step value. For example, setting the step size to 1/8 moves through the sequence one eighth note, or 48 clocks, with each press of the > (Play) button.

6.10a Step Edit Operations

To play back a sequence in step edit mode:

1. Press the **Edit** Sequencer button.
2. Press the *Step* soft button.
3. Select the step size (section 6.10).
4. Press the || (**Pause**) button.
5. Press > (**Play**) button to tell the sequencer you want to begin playback.
6. Press > (**Play**) button again to position the sequencer at the first clock of the current bar.
7. Press > (**Play**) button to step through the sequence at the selected step size. The bar/beat/clock counter will change to show where you are in the sequence.

To enter step mode from normal playback:

1. Select the desired step size then start normal playback.
2. Press the || (**Pause**) button.
3. Press the > (**Play**) button to step through the sequence at the selected step size. The bar/beat/clock counter will not be visible if you enter step mode from normal playback, although the Transport bar/beat counter will increment as in normal playback. To see the bar/beat/clock step edit counter, press the **Edit** Sequencer button then the *Step* soft button.

Rewinding and fast forwarding while in step mode:

1. To rewind or fast forward, press the << (**Rewind**) button or >> (**Fast Forward**) button respectively.
2. The display reverts to the Transport, which will be in paused mode.
3. The sequencer status is now equivalent to entering step mode from normal playback. Either release pause to start normal playback or enter step mode (press **Edit** Sequencer button, then press the *Step* soft button).

To record in step edit mode:

1. Press the **Edit** Sequencer button.
2. Press the *Step* soft button.
3. Select the step size (section 6.10).
4. Press the || (**Pause**) button.
5. Press O (**Record**) button to enter the RCRDY mode.
6. Press > (**Play**) button to enter RECRD mode.
7. Press > (**Play**) button again to position the sequencer at the first clock of the current bar.
8. Press > (**Play**) button to step through the sequence at the selected step size. The bar/beat/clock counter will change to show where you are in the sequence.
9. When you reach a bar/beat/clock where you want to record, play the note(s) to be recorded.

To erase in step edit mode:

1. Press the **Edit** Sequencer button.
2. Press the *Step* soft button.
3. Select the step size (section 6.10).

4. Press the || (**Pause**) button.
5. Press ● (**Erase**) to enter the ERRDY mode.
6. Press > (**Play**) to step to the location where erasing should begin.
7. Press ● (**Erase**) again to enter ERASE mode.
8. Press > (**Play**) to step through the sequence until you reach the last step where erasing is to occur.
9. Press ● (**Erase**) again to exit ERASE mode and return to ERRDY.

To erase+record in step edit mode:

1. Press the **Edit** Sequencer button.
2. Press the *Step* soft button.
3. Select the step size (section 6.10).
4. Press the || (**Pause**) button.
5. Press ● (**Erase**) to enter ERRDY mode and ○ (**Record**) to enter RCRDY mode.
6. Press > (**Play**) to step to the location where erasing+recording should begin.
7. Press ● (**Erase**) again to enter ERASE mode and ○ (**Record**) again to enter RECRD mode.
8. Press > (**Play**) to step through the sequence at the selected step size. When you reach a bar/beat/clock where you want to erase+record, play the note(s) to be recorded.
9. Press ● (**Erase**) again to exit ERASE mode and return to ERRDY and/or ○ (**Record**) to exit RECRD mode and return to RCRDY.

Once you get familiar with step edit options, you'll find it's easy to bounce back and forth between normal recording and step edit modes. Remember, you can enter step edit at any time during normal sequencer operation by pressing the || (**Pause**) button, then pressing the appropriate transport controls (see above). To exit step edit mode at any time, simply release || (**Pause**).

6.11 CONSTRUCTING A SONG

A DPM song is a play-list of sequences resident in the DPM. This play-list specifies which sequences will play, their order, and how many times individual sequences repeat before the next sequence in the play-list begins playback.

Note: To play a song, all sequences that make up that song must be in memory. The Save All Sequences storage function saves all sequences and associated songs.

To name, clear, or build a song play-list:

1. Select a song to be named, cleared, or created (section 6.3). This sets the storage location for the song edit functions (described in the following three sections).
2. Press the **Edit** Sequencer button, then press the *Songs* soft button. The display shows:

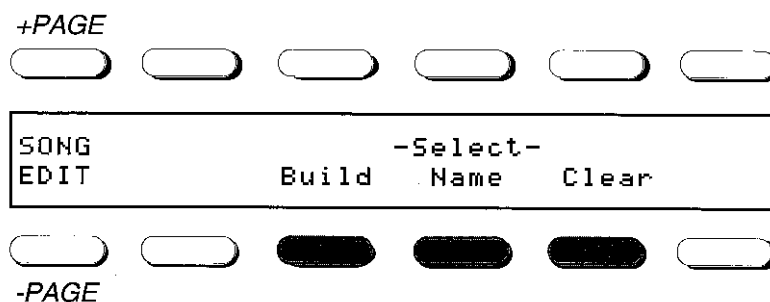

6.11a Name/Save a Song

1. Press the *Name* soft button. The following display appears:

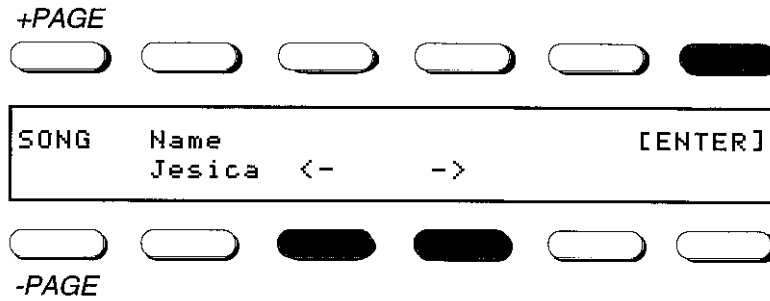

- Use the <- and -> soft buttons to choose the character in the name to be changed, then use the data slider or data wheel (DPM 4) to select the character.
- Press the **Enter** button to save the song in memory.

6.11b Clear a Song

1. Press the *Clear* soft button. The following display appears:

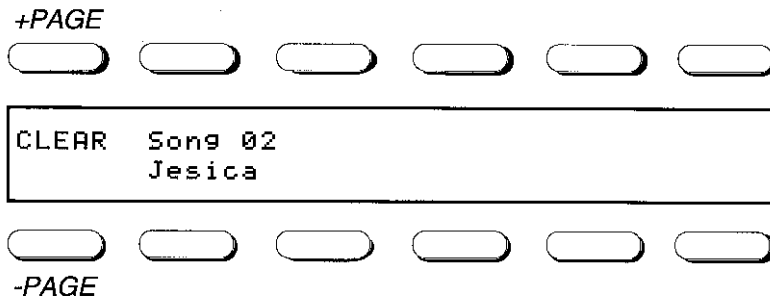

2. Press the **Enter** button to clear the song from memory.

6.11c Build a Song

1. Press the *Build* soft button. The screen shows:

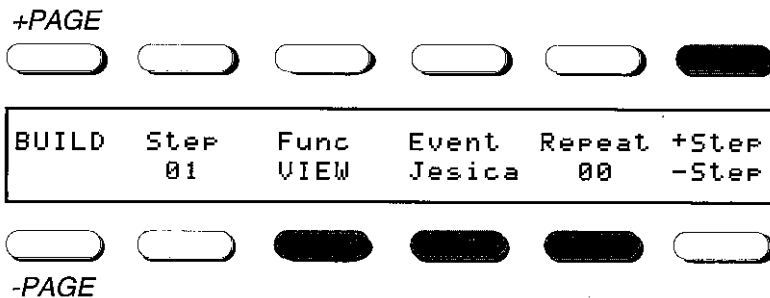

Step

Shows the current song step being edited. A song can have up to 76 steps.

Func

Selects among: View (play-list), Insert (step), Change (step), and Delete (step).

Event

Selects the type of event to occupy the step: a sequence, a tempo change, or END (indicates the end of the song).

Repeat/Tempo

If the Event is a sequence, Repeat will be displayed. This allows you to set the number of times the sequence will be repeated before going to the next step.

If the Event is tempo, Tempo will be displayed. This lets you set the tempo for the song.

+Step

Scrolls to the next step.

-Step

Scrolls to the previous step.

2. The following section describes the options for these buttons in more detail.

6.11d Song Building Options

Each step can hold either:

- A Sequence and repeat information for that sequence (e.g., repeat 4 times before going over to the next sequence),
- A tempo value to change tempo, or
- An End marker to indicate the end of the song.

A song can contain up to 76 steps. The display shows which song step is selected; use *-Step* or *+Step* to select different steps for editing. These functions scroll through the steps one at a time.

6.11e Building a Song

1. Choose the step to hold the data.
2. Choose the desired event for the displayed step.
 - If this event is a sequence, a soft button for *Repeat* will appear alongside *Event*. Press the *Repeat* soft button and select the number of times the step will repeat.
 - If the event is a tempo change a soft button for *Tempo* will appear under alongside *Event*. Press the *Tempo* soft button and select the tempo.
3. Press the *Func* soft button and select INSERT. This registers the step in the play-list.
4. Press *+Step* to move to the next step.
5. Repeat steps 1-3 until the song is complete. Enter END for the last step.

6.11f Editing a Song

As soon as you move off a step using the *-Step* or *+Step* button, the function changes to View. This allows you to scroll from step to step without altering the play-list. If you want to alter the play-list, you can:

- **Change a Step**

1. Select the step with the event to be changed.
2. Select the new event for the step.
3. Press the *Func* soft button and select CHANGE.
4. Press either the *+Step* or *-Step* button.

The new event will replace whatever previously occupied that step.

- **Delete a step**

1. Select the step with the event to be deleted.
2. Press the *Func* soft button and select DELETE.
3. Press either the *+Step* or *-Step* button.

The next time you view the play-list, the deleted event will no longer be there. The events after the deleted step will close in to fill the gap created by the deleted step; therefore, the step number associated with subsequent steps will be one less than it was prior to deletion.

- **Insert a Step**

1. Select the step where you want to insert a new step.
2. Select the new event for the step to be inserted.
3. Press the *Func* soft button and select INSERT.

The next time you view the play-list, the inserted step will appear in the play-list. The events after the inserted step will be pushed ahead to make room for the inserted step; therefore, the step number associated with subsequent steps will be one more than it was prior to insertion.

Chapter 7: Sample Editing

7.1 ABOUT SAMPLING

The DPM oscillators play back sampled sounds called *waves*. These are recorded, digitized, and stored in ROM (permanent memory) chips by Peavey for use in the DPM. However, the DPM can also include up to 1 Megabyte of battery-backed-up RAM that contains your own samples. You can store real-world sounds (anything from an orchestra hit to a plucked guitar string to a dog bark) in this memory, which you can then play back from the DPM keyboard. With sampling, you are not limited to the on-board waveforms included in the DPM; the world is your waveform, once you manage to get it into memory. Samples show up in the Wave1 and Wave2 wave parameters, at the end of the on-board factory waves.

The DPM can load samples in four main ways:

- **From the DPM disk drive.** Samples can be stored on DPM disks and loaded into the DPM. Peavey and various third party developers (such as Proonus) offer samples on disk for the DPM.
- **From another sampler or DPM.** This takes advantage of a provision of the MIDI specification, the Sample Dump Standard (SDS), which specifies a universal way to exchange samples over the MIDI line between those instruments whose specifications conform to the SDS. (Unfortunately, not all samplers are SDS-compatible and may use their own methods of data transfer.)

For optimum fidelity the DPM is a 16-bit machine, and therefore performs best with 16-bit samples. Although you can transfer 8 and 12-bit samples to the DPM, this does not convert them to 16-bit sample quality—they will play back with the same basic fidelity as they did on the source machine.

- **From sample editing computer programs.** These programs (such as *Sound Designer* and *Alchemy* for the Macintosh, *Avalon* and *Genwave* for the Atari, *Sample Wrench* for the Amiga, and *SampleVision* for IBM machines) exist for virtually all popular computers. Most programs can load samples into computer memory from a computer disk containing samples, a CD ROM disc containing samples, or another sampler. These samples can then be sent from the host computer to the DPM over the MIDI line.

As a bonus, sample editing programs usually provide a convenient work around for samplers that don't conform to SDS. These programs can transfer samples between the computer and those samplers supported by the program, regardless of whether or not they support SDS. The program should also be able to translate samples that use incompatible formats. Therefore, a non-SDS sample can be brought into the program, translated, and sent out over MIDI as an SDS sample to the DPM, thus opening up a potentially huge library of samples.

- **From the Peavey SX/SX II sample expanders.** These devices are (among other things) digital audio recorders that can record a sound, digitize it, store it in a buffer memory, and then send the sample to the DPM. After loading a sample, the DPM creates a special "audition" program in the program memory buffer so that you can listen to and edit the sample. It is therefore not necessary to create a special program and assign a sample to its waves in order to hear the sample.

Note 1: With SDS-compatible devices, there are two possible ways to load samples. The device containing the sample to be transferred can send a sample to a DPM, or the DPM can request a particular sample (as identified by a number) from a sample-editing program or sampler capable of sending samples as SDS data. When transferring samples, loop and sample length parameters (as described later) in the source sample are retained in the DPM.

Note 2: Different samples are often taken at different sample rates, with lower sampling rates trading off poorer fidelity for greater memory efficiency. In many sample transfer applications it is important to match sample rates, but the DPM performs an automatic sample rate conversion routine to insure compatibility. This process does not alter the sample length, which will be the same in the DPM as in the source. Also, please note that sample rate conversion cannot improve the sound of a sample originally recorded with a low sample rate. The DPM will faithfully reproduce whatever you put into it; put in a horrible-sounding sample, and the DPM will play back a horrible-sounding sample.

7.2 SAMPLE TRANSPOSITION

A sample is initially assigned to a single key on the keyboard. *Example:* If you record a plucked guitar string at middle C, this would be assigned to middle C on the keyboard (although you could assign it to another pitch if desired). The originally recorded pitch is called the *original pitch*. However, since each sample takes up a certain amount of memory, it is impractical to record one sound for each key. As a result, a single sample can be transposed over a range of notes.

Transposition can also be used as an effect. In *Raiders of the Lost Ark*, where a gigantic stone ball rolled toward Indiana Jones, the sound of that rolling ball was simply a microphone taping the rear wheel of a Honda car going down a gravel driveway. However, this source sound was slowed down and otherwise modified, thus producing the awesome sound heard in the movie.

7.3 ABOUT MULTI-SAMPLING

The further a note is transposed from its original pitch, the more unrealistic it sounds, especially with acoustic instrument samples. The problems are the same as changing speeds on a tape recorder; transposing up gives “munchkinization” (i.e., the sounds are thin and unnatural), whereas transposing down creates “Darth Vader” effects with muffled, deep sounds. These effects are not always undesirable—transposing a bass up far enough can create an entirely new type of sound—but for maximum realism, it’s best not to transpose a sound too far.

Because of this, the DPM allows for *multi-sampling*, where several samples (perhaps at octave or fifth intervals) are used to cover the keyboard range. Thus, no note will have to be transposed over too wide a range, resulting in more realistic timbres.

The trade-off is that more samples use up more memory. As a result, it’s usually best to concentrate on grouping the greatest number of samples towards the most-played range of the keyboard. For example, some “bassy” sounds can be transposed downwards up to an octave or so without sounding too unnatural. Likewise, for some sounds—like cello—you’re not going to play too much in the top octave. Therefore, one sample might suffice for, say, the top octave and a fifth.

For maximum user convenience, these multi-sampled waves are still saved as a single wave. For

example, a multi-sampled guitar will show up as a single Guitar wave. (Of course, you can save each sample individually and assemble them in a Combi patch, but there is seldom any advantage to doing things this way.)

7.4 MEMORY AND SAMPLE TIME

Samples (in fact, any digital audio signals) use up a lot of memory. One megaword (two Megabytes) of sample memory allows for about thirteen seconds worth of samples, but that sample time can be partitioned in several different ways: a single 13-second sample, two 7.5-second samples, a 10-second sample and three 1-second samples, and so on. It is also possible to save memory in other ways, such as trimming and looping, which are described later.

7.5 DEFINITION: WAVES AND SAMPLES

A *wave* is what shows up in the Wave1 and Wave2 wave parameters. A wave can consist of a single sample, or a number of samples arranged to form a multi-sample. All waves contain samples, but not all samples are waves, since some waves have multiple samples (i.e., a multi-sampled wave).

The DPM holds up to 32 waves and 48 individual samples (some waves will probably be multi-sampled, hence the ability to load in more samples than waves). Attempting to load more than 48 samples or 32 waves will produce an error message in the display.

7.6 ABOUT SAMPLE LOOPING AND TRIMMING

Looping is an important way to save memory. It takes advantage of the fact that many acoustic sounds start with a complex initial transient, then settle down into a steady, repeating waveform. Consider a flute; it starts off with a burst of noise and a fairly complex sound, but then settles into a sustained tone.

Rather than play back this entire sustained tone, we can mark off a small part of the repeating waveform and play it over and over again through a process called *looping*.

The following figure shows the amplitude envelope for a typical unlooped flute sound.

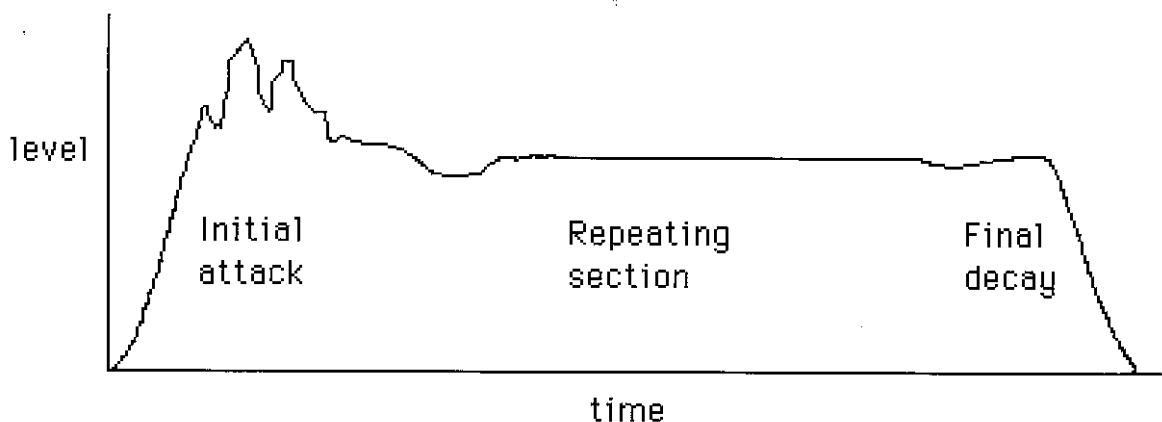

Note how there is a repeating section that occurs between the initial attack and final decay. This looks like a good place to create a loop; the following shows where we might put the loop.

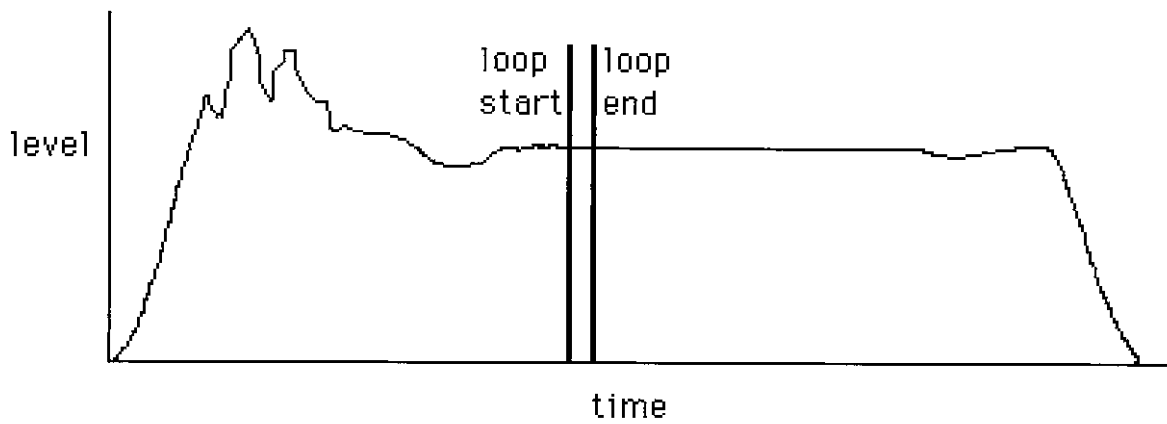

When you press a key, the sample plays normally until it reaches the end of the loop. It then jumps back to the loop start point and plays the looped section again, jumps back to the beginning, plays through the loop again, and keeps repeating the looped section for as long as the key is held down. Thus, a looped sound can sustain indefinitely.

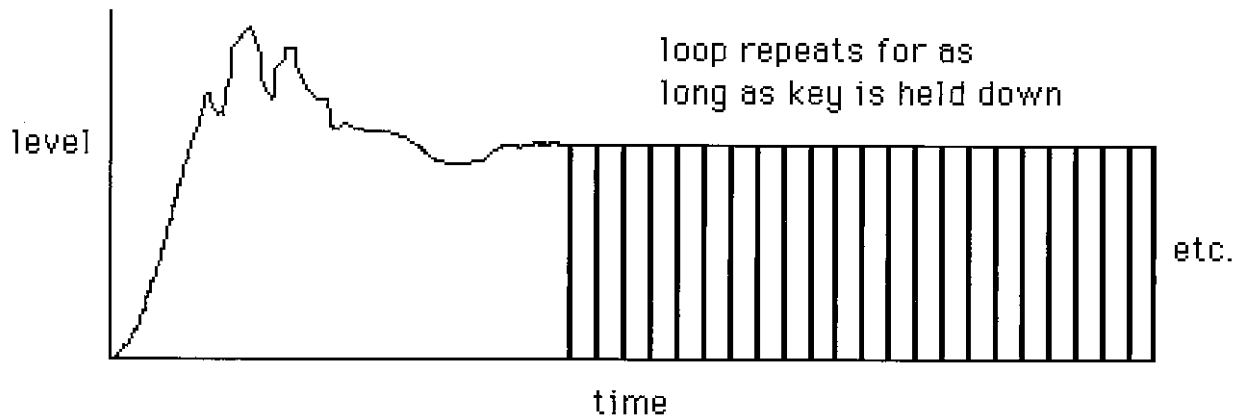

Since we no longer need the part of the sample that extends past the loop end, we can trim it off and reclaim a bunch of memory. Compare the figure below the original flute sample; the sample size has been cut in less than half, thus cutting memory requirements by more than half, as well.



Trimming can trim the beginning of the sample, which is useful if some “dead space” got sampled before the attack kicked in. Trimming can also serve as an effect; some sounds change character completely when, for example, you cut off the first few milliseconds of the initial attack.

We have one remaining task: simulating the final decay of the original flute sound. This is easy to do by setting a short release time with an amplitude envelope generator. Upon releasing the key, the envelope generator will superimpose a decay on the looped signal.

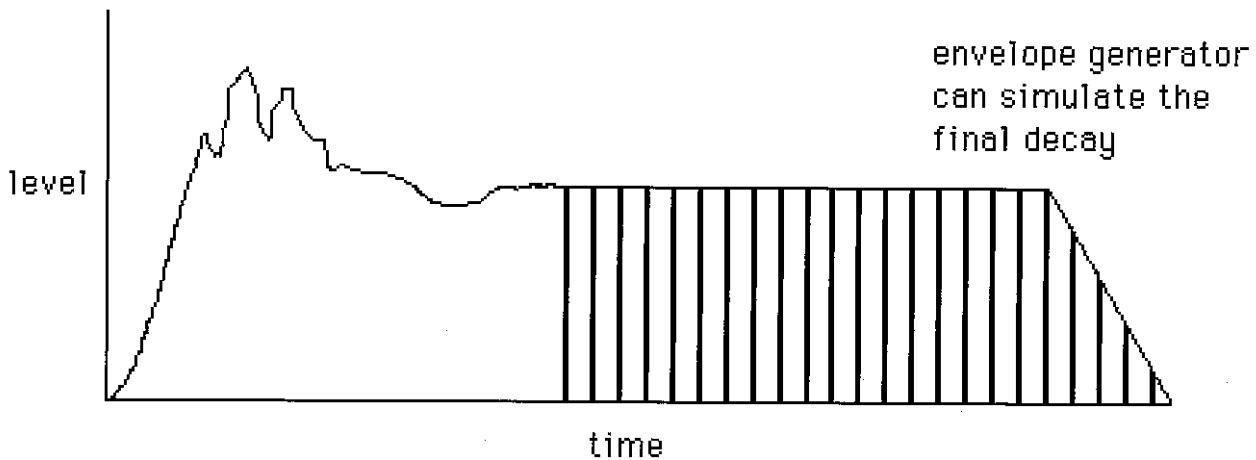

7.7 ACCESSING SAMPLING FUNCTIONS

All sampling functions are located in the Sample RAM option (Global menu). To enter the land of sampling:

1. Press the **Global** System button.
2. Press the *-Sample Ram-* soft button in the lower right corner. The Samples menu, the main menu for the sampling section, appears:

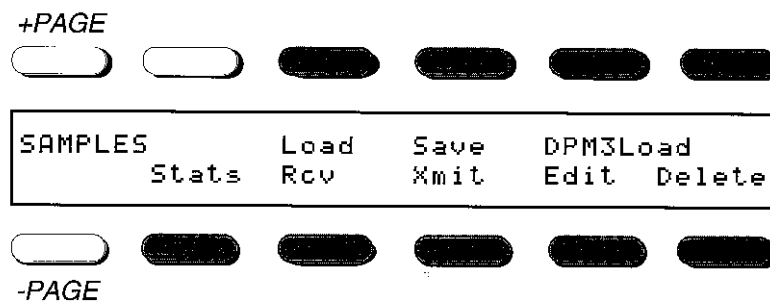

Select the desired function by pressing the associated soft button. We'll next describe each menu option in detail.

7.8 LOAD (SAMPLE FROM DISK)

To transfer samples from disk into the DPM:

1. Place the disk containing the samples to be loaded in the drive. If you are not familiar with disk handling procedures, read section 9.7.
2. Press the *Load* soft button in the samples menu. The display shows:

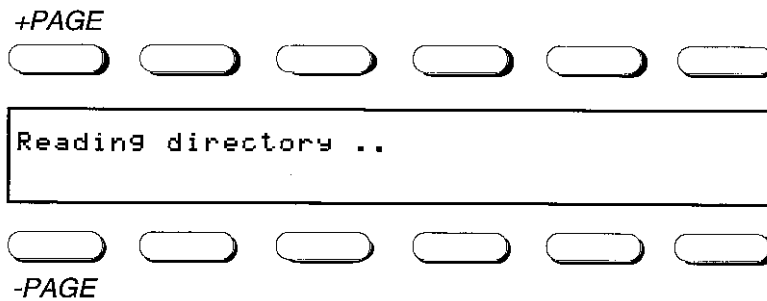

If the disk contains samples, the display says something like:

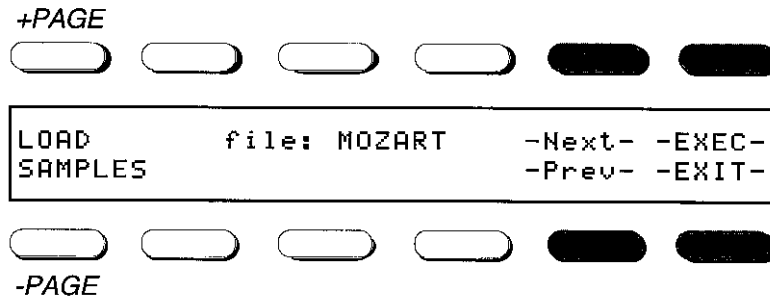

This is where you choose the sample to be loaded.

file

Shows the name of the current sample that's available for loading (or "no SMPs" if the disk contains no samples or "No format detected on this disk" if the disk is not a DPM disk).

-Next-

Scrolls you to the next sample in the list of available samples.

-Prev-

Returns you to the previous sample in the list of available samples.

-EXIT-

Returns operation to the main Samples menu.

-EXEC-

Loads the sample into memory. The longer the sample, the longer the loading process; the display says "Loading from disk .." while loading.

Upon loading a sample, the next file name in the list of samples will appear. Therefore, you can load a series of samples by simply pressing **-EXEC-** until all samples are loaded.

7.9 SHOW (SAMPLE MEMORY STATUS)

To check on the amount of free memory and how much memory the samples in the DPM are using:

1. Press the *Stats* soft button in the samples menu. With one sample in a fully-loaded DPM with 512 kilobytes of RAM, the display shows something like the screen below.

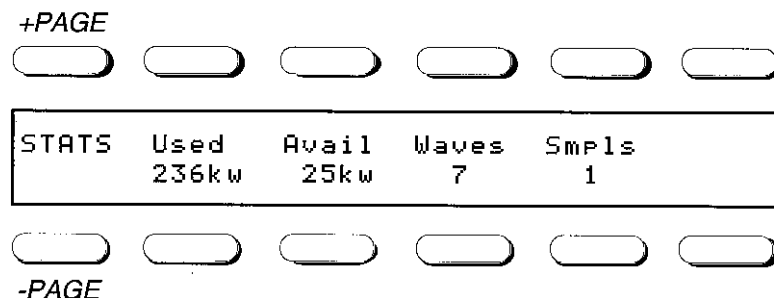

2. This screen shows the sample RAM status. All numbers are expressed in *words*, each of which uses two *bytes* of memory. Therefore, a machine with 524,288 bytes of RAM (512 kilobytes) has 262,144 words of RAM available.

Used

Shows the amount of memory currently taken up by the samples in RAM. The more samples you load into memory, the bigger this number will be.

Avail

Shows how much memory, in words, is available for loading in new samples.

Waves

Shows the number of waves currently in memory.

Smpls

Shows the number of samples currently in memory.

7.10 RCV (RECEIVE A SAMPLE FROM AN SDS-COMPATIBLE DEVICE)

The following procedure requests a sample from an SDS-compatible device and loads it in RAM.

1. Connect a MIDI cable from the DPM's MIDI Out to the MIDI In of the computer or sampler providing the sample to be loaded.
2. Connect a MIDI cable from the DPM's MIDI In to the MIDI Out of the computer or sampler providing the sample to be loaded. These MIDI connections must be made to provide two-way communication (handshaking) between the DPM and sampler/computer.
3. Press the **MIDI** System button. Select the base channel over which you want to transfer the sample by pressing the *InCh* soft button and selecting the desired channel. Press the *Mode* soft button and select Omni or Poly mode.
4. Press the **Global** System button and press the *-Sample Ram-* soft button to access the main Samples menu.
5. Press the *Rcv* soft button. The display shows something like:



- The default mode is **Request #01** (or the first free sample number if sample #01 already exists in memory), which lets you “grab” (request) a particular numbered sample from a computer or sampler and load it into the DPM. Press the *Mode* soft button, then choose the desired sample number with the data slider (selects samples 00-254); the data wheel (DPM 4) selects samples 00-16,383.

The DPM is always ready to receive a sample from another source (unless the Trim page, section 7.12, is selected); all that’s necessary is to initiate a sample send (dump) command at the remote device. This is often the easiest way to get samples into the DPM. Scrolling below **Request #00** calls up a **Remote** data transfer option, but it is not necessary to call this up for the DPM to receive samples. This is included so that if you don’t have the manual and scroll through the display, you’ll be aware that the DPM can receive samples from other sources.

Note: The default sample number is significant because all sample numbers lower than the default sample number correspond to an existing sample.

- After selecting the desired data transfer mode and/or sample number, press the **[EXEC]** button. *If you request a sample with the same sample number as a sample already present in DPM RAM, that sample will be replaced with the sample being loaded.*
- If the DPM was set to request a sample, the dump process should begin automatically. It may take a couple of seconds after sending the request for the sampler or computer to respond; this is normal. If there is no response, make sure that the sample source and DPM are set to the same MIDI channel, the correct sample number was specified in the request process, and SysEx is set to **On** in the MIDI Filter page. If the DPM was set to **Remote**, continue reading; otherwise skip to step 11.
- After selecting **Remote** and pressing **[EXEC]**, the display will usually say **Waiting for SDS dump on MIDI channel 01** (or whatever base channel you chose in step 3).
- Initiate a sample dump (transmission) at the computer or sampler, which must be set to the same basic channel as the DPM. If you send a sample with the same sample number as one already present in RAM, that sample will be replaced with the sample being loaded.
- The display will say **Sample Dump** and show a countdown of how many bytes remain to be transferred into the DPM. Note that MIDI sample transfers can take quite a while with long samples; be patient.
- Shortly after the display says **Dump Complete**, the Audition screen appears:

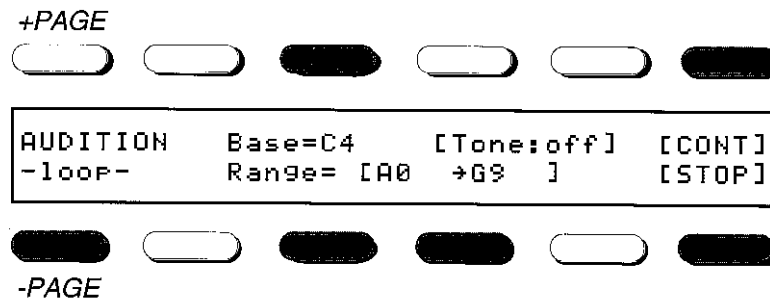

This screen lets you set several sample parameters. Here's what the various soft buttons do.

Base

Selects the base note (original pitch). For example, if the sample you loaded in had an original pitch of B3, you'd probably set this to B3. Otherwise, when you played C4, you'd hear a note pitched at B3. You can also use this function to transpose a note to a different range if desired. *Example:* Choosing B4 instead of B3 will lower the sample an octave since the original pitch will be placed higher up on the keyboard.

Tone

When ON, this provides a reference tone that tracks the keyboard. The main purpose of this tone is to let you compare the pitch of the sample with the reference pitch and verify that the base note has been set to the proper pitch, so that playing for example, a C actually produces a C and not some other note. The reference tone also comes in handy for setting loop points, as described later.

Range

This sets the high note of the sample's range. The DPM assumes that you will load in samples from the low end of the keyboard to the upper end, so the first sample will automatically default to a low note of A0 and high note of G9. If you are *not* multi-sampling and using a single sample for a wave, press **[STOP]** and skip to step 14.

If you are multi-sampling, press the associated *Range* soft button and select the upper pitch limit for the sample that was just loaded. Keys above this range will not sound.

-loop-

This takes you to the sample edit zone so that you can create or alter loop points and/or trim off unneeded portions of the sample to save memory. These operations are described later, but note that you can perform edits while multi-sampling—set the edits properly for one sample before moving on to the next one.

13. After setting the upper pitch limit for the first sample of a multi-sample (see previous step), press **[CONT]** and the Rcv screen will appear again. Repeat steps 6-12, but note that in step 12, the range's low end will default to one semitone above the high end of the previous sample's range, and the high note will be G9. Set the high note as desired. Repeat this procedure for as many multi-samples as you need to build up a complete sound, then press the **[STOP]** soft button.

Note: Once the high note is assigned to G9, there is no more room to add samples. As a result, the DPM will assume that if the highest sample range extends to G9 or you press **[STOP]**, you are finished transferring the multi-samples for a particular wave. *Important: When sending a sample*

to the DPM, the computer program or sampler may ask you to specify a sample number. If this is the same as the one you just transferred, the previously transferred sample will be overwritten.

- Once sampling for a particular wave is complete as indicated by your pressing **[STOP]**, the DPM will automatically select the Wave Name screen:

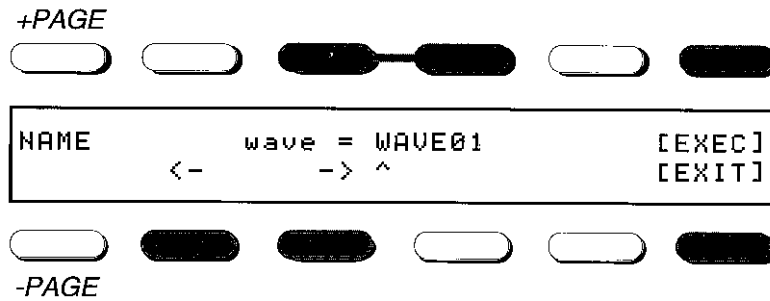

To name, press the *wave* soft button so that the = sign flashes. Use the <- and -> buttons to move the cursor under the character to be changed, then select the desired character. Press **[EXEC]** when you're done, or **[EXIT]** to use the default wave name.

7.11 XMIT (TRANSMIT A SAMPLE TO AN SDS-COMPATIBLE DEVICE)

The following procedure transmits a sample from the DPM to an SDS-compatible device, such as another sampler or a computer-based sample editing program.

- Connect a MIDI cable from the DPM's MIDI Out to the MIDI In of the destination computer or sampler.
- Connect a MIDI cable from the DPM's MIDI In to the MIDI Out of the destination computer or sampler. These MIDI connections must be made to provide two-way communication (handshaking) between the DPM and sampler/computer.
- Press the **MIDI** System button. Select the base channel over which you want to transmit the sample by pressing the *OutCh* soft button and selecting the desired channel.
- Press the **Global** System button and press the *-Sample Ram-* soft button to access the main Samples menu.
- Press the *Xmit* soft button. The display shows something like:

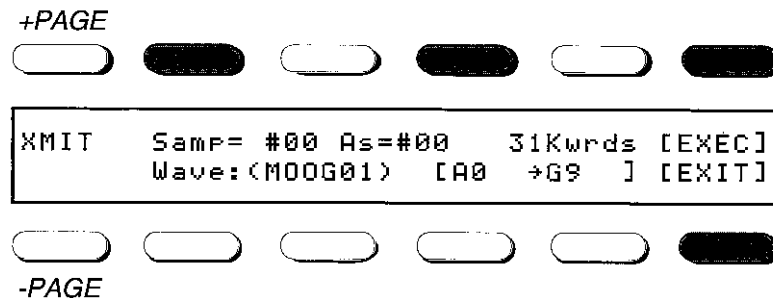

This screen lets you select a sample for transmission and provides information about the sample.

Press the *Samp* soft button then select the sample number within the DPM to be transmitted; data in the other fields will change to reflect the selected sample's characteristics. Scrolling past the highest-numbered sample selects **All**, which means that all samples will be transmitted.

The number to the right of the sample number indicates the size of the sample in Kilowords (thousands of words). In the example above, Sample #00 has a sample size of 31 Kwords (31 Kwords = 31,000 words = 62,000 bytes = 62 Kbytes).

Wave:

Shows the name of the sample's "parent" wave. This is the name that will show up when assigning a wave to Wave1 or Wave2; in this example, the wave name is **MOOG01**.

The letters and numbers to the right of Wave: indicate the key range covered by the sample. In this example, Sample #00 covers the range of A0 through G9.

If the upper note for the range is lower than G9, then the sample is part of a multi-sample. Scrolling to the next higher-numbered sample will show the next higher-pitched sample of the multi-sample.

6. After selecting the desired sample number, make sure that the receiving device is ready to accept a sample dump from the DPM. The procedure for doing this varies for different devices; check the device's manual.
7. Press the **[EXEC]** button to transmit the sample. A screen similar to the following appears:

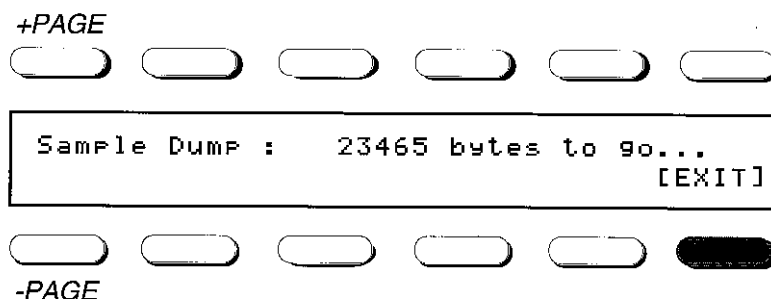

In this example, the number of bytes remaining to be sent is 23,465 bytes. As the sample is transmitted, this number will count down until it reaches 0 bytes, at which point the sample transfer is complete and the DPM returns to the main Samples screen.

You can cancel the transfer process at any time by pressing **[EXIT]**. The DPM then returns to the main Samples page.

7.12 EDIT (EDIT SAMPLES IN MEMORY—LOOP AND TRIM)

Several sample parameters can be edited to optimize the sample's usefulness. In the main Samples menu, press the *Edit* soft button (you can also access the Edit screen from the Audition page, as described earlier). The display shows something like:

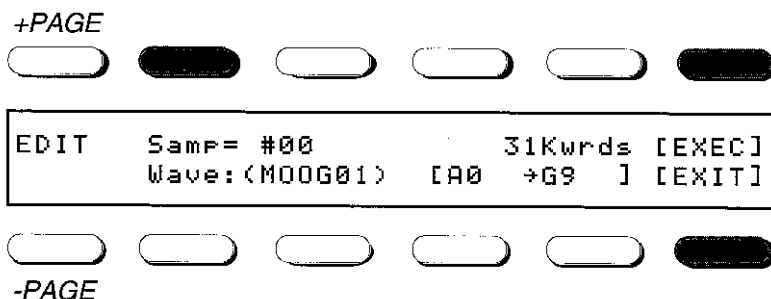

1. Choose the sample to be edited by pressing the *Samp* soft button, selecting the desired sample number, then pressing **[EXEC]** (**[EXIT]** returns you to the main Samples screen). The other fields show data about the sample being edited, as on previously described screens (memory used, wave name, and sample key range).
2. The Audition screen now appears (possibly after a screen that says Reallocating Memory if the DPM needs to do some RAM housekeeping). The Audition screen's functions were previously described in section 7.10. Press the *-loop-* soft button to enter the looping screen.

Note: If memory reallocation will take more than 15 seconds, you will be given an option to back out. The fewer samples in RAM during reallocation, the less time RAM housekeeping will take.

3. The Loop edit screen now appears and shows something like:

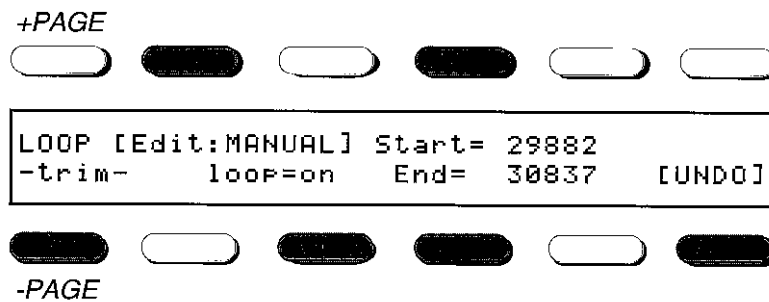

Here's what the soft buttons do.

Edit

Chooses between auto and manual modes, as selected with the data wheel (DPM 4). In auto mode, the DPM will always place a loop point on a zero crossing (i.e., where the signal crosses over from the positive to negative quadrant or vice-versa, and therefore has zero amplitude). Placing a loop point on a zero crossing often results in a smoother loop. If auto is one when adjusting one loop point (start or end), it should be on when adjusting the other loop point.

The data slider is always in manual mode regardless of how edit is set. This allows you to make rough adjustments, then use the data wheel (DPM 4) fine adjustments.

Start

Sets the loop start point, as shown by a number that indicates how many sample "words" into the sample the loop begins.

loop

Turns loop on or off.

End

Sets the loop end point, as shown by a number that indicates how many words into the sample the loop ends.

-trim-

Accesses the next editing page, which lets you trim sample words from the beginning or end of the sample.

[UNDO]

This cancels any loop point adjustments you may have made *while on this screen*, and returns the DPM to the Audition page. If you leave this screen, the new loop points are retained and cannot be undone.

4. To trim the sample by setting a new start point and discarding all samples prior to the start point, press the *-trim-* soft button. The display shows something like:

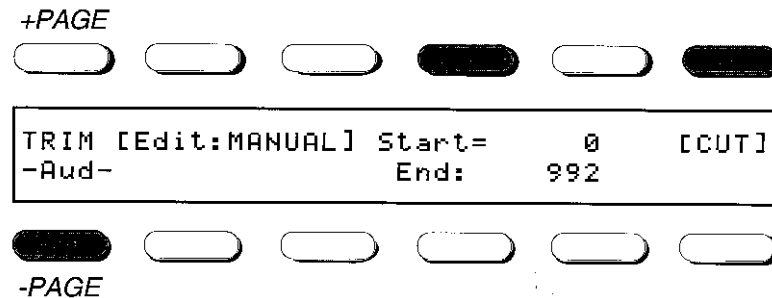

Here's what the soft buttons do.

Edit

Chooses between auto and manual modes. In auto mode, the DPM will always set the start point at a zero crossing (i.e., where the signal crosses over from the positive to negative quadrant or vice-versa, and therefore has zero amplitude). This is important because a sample that doesn't start at zero, but at some particular amplitude, will usually produce a "click" at its beginning.

Start

Sets the new sample start point.

End

With unlooped samples, sets the new sample end point. With looped samples, the End is automatically set one sample after the loop end point, since any samples past the loop end are not needed.

[CUT]

Pressing this deletes all samples before the start point and after the end point. The display will show Reallocating Memory during the cutting process, after which the DPM will return to the Trim screen in case you want to do more trimming.

-Aud-

This returns to the Audition screen, whereupon you can press [CONT] if you're in the process of multi-sampling, [STOP] if you've finished all operations on this particular sample, or **-loop-** if you want to cycle through the edit screens again.

Note: The only way to escape from the Trim screen is by pressing the **-Aud-** button. Also, this is the one screen where incoming sample dumps will not be accepted.

7.13 DELETE (DELETE SAMPLES AND WAVES FROM MEMORY)

Because samples are loaded into battery-backed RAM, if you run out of space to store samples, it is necessary to delete a sample to create room for new samples.

It is possible to delete either individual samples, including those that make up a multi-sampled wave, or entire waves if you want to delete all multi-samples in the wave with one operation.

In the main Samples menu, press the *Delete* soft button. The display shows something like:

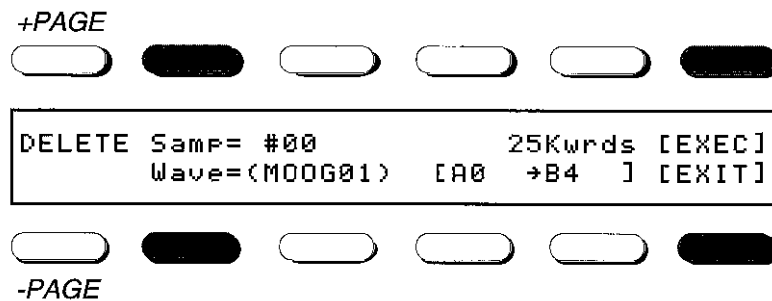

This screen lets you select samples or waves for deletion and provides information about the sample or wave to be deleted.

7.13a Deleting Samples

1. Press the *Samp* soft button.
2. Select the sample number within the DPM to be deleted; data in the other fields will change to reflect the selected sample's characteristics. Scrolling past the highest-numbered sample selects **All**, where all samples in RAM will be deleted.

The number to the right of the sample number indicates the size of the sample in Kilowords. This lets you know how much memory will be reclaimed by deleting the sample.

Wave:

Shows the name of the "parent" wave containing the selected sample. In this example, the name is **MOOG01**. The letters and numbers to the right of Wave indicate the key range covered by the sample. In this example, Sample #00 covers the range of A0 through B4.

If the upper note for the range is lower than G9, then the sample is part of a multi-sample. Scrolling to the next higher-numbered sample will show the next higher-pitched sample of the multi-sample.

3. After selecting the sample to be deleted, press the **[EXEC]** soft button to delete.
4. After deleting the desired samples, exit the delete function by pressing the **[EXIT]** soft button.

7.13b Deleting Waves

1. Press the *Wave* soft button on the Delete screen. The display shows something like:

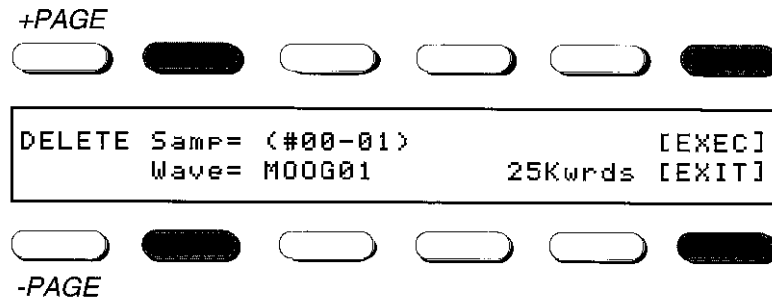

This screen lets you select waves for deletion and provides information about the wave to be deleted.

2. After pressing the *Wave* soft button, select the wave to be deleted; data in the other fields will change to reflect the selected wave's characteristics. Scrolling past the highest-numbered sample selects **All**, where all samples in RAM will be deleted.

Samp

This now indicates the sample numbers contained in the selected Wave. In the example above, **MOOG01** includes samples 00-01, so this is a multi-sample with two samples. If both numbers are the same, the wave consists of a single sample.

The number to the right of the wave name indicates the total size of all samples in the wave in Kilowords. This lets you know how much memory will be reclaimed by deleting the wave. A key range is not shown.

3. After selecting the wave to be deleted, press the **[EXEC]** soft button to delete.
4. After deleting the desired waves, exit the delete function by pressing the **[EXIT]** soft button.

7.14 USING AN SX / SX II WITH THE DPM KEYBOARD

The DPM® SX and DPM® SX II are designed for optimal use when set up with the DPM keyboards. When the SX /SX II is connected to the DPM, several operating system displays will be available on the DPM that are not available otherwise. These displays are available under the **Global** System button and the *-Sample Ram-* soft button.

To get the most from the SX/SX II, connect it to the DPM in the following manner:

- Connect both MIDI cables to the units, this allows commands and data to be sent in both directions.

If you have a complex MIDI system setup, you might want to use a MIDI data processor/patcher such as the Peavey MIDI Master™ II to allow for the most flexible MIDI cabling. The MIDI Master II will allow a number of MIDI instruments and controllers to be interconnected in different configurations without having to reconnect the cables each time a new MIDI configuration is needed.

- Connect the rest of your MIDI system in the way that best suits your needs.

- Turn on each unit in your system.
- Connect your music or instrument “sound” source to the front panel of the SX /SX II. Use the 1/4 ” phone jack for line level input or the XLR jack for any microphone level input signal (phantom powered or otherwise).

Note: The DPM automatically senses if you are connected to an SX or SX II and displays the appropriate screens.

7.14a RCV (Receive a Sample from an SX)

The following procedure requests a sample from an SX and loads it in RAM.

1. Connect the MIDI cabling as described earlier.
2. Press the **MIDI** System button. Select the base channel over which you want to transfer the sample by pressing the *InCh* soft button and selecting the desired channel. Press the *Mode* soft button and select OMNI or POLY mode.
3. Press the **Global** System button and press the *-Sample Ram-* soft button.
4. Press the *Rcv* soft button. The display shows something like (SX screen):

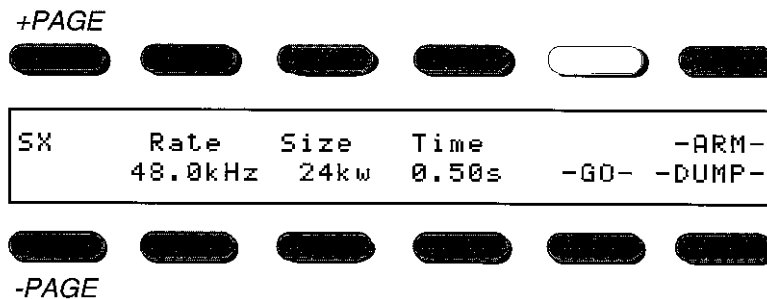

Rate

This lets you select the sample rate. Choose from 16 kHz, 24 kHz, 32 kHz, 38.4 kHz (sample rate for the DPM), 44.1 kHz (sample rate for DPM® SP) and 48 kHz.

Size

Selects the size of the sample. This ranges from 1 kiloword to the maximum available (unused) memory. Notice that when you change the size of the sample the time parameter also changes to reflect the number of seconds the sample will use.

Time

Selects the length of the sample. The smallest interval for capturing a sample is .02 seconds. The largest interval depends on the amount of memory available as well as the sample rate selected. The higher the sample rate the less time you have to capture your sample. For example, at a sample rate of 48 kHz with 1 megabyte of memory, the total sample time is approximately 11 seconds (for a mono sample).

-GO-

Press this to “manually” start the sampling process.

-ARM-

This provides automatic sampling. When the *-Arm-* soft button is pressed, the sampling process will begin with the predetermined “trigger” method.

-DUMP-

Press this to transfer the sample from the SX to the DPM.

5. Press the *+Page* (or *-Page*) button to access the second page of the SX screens.

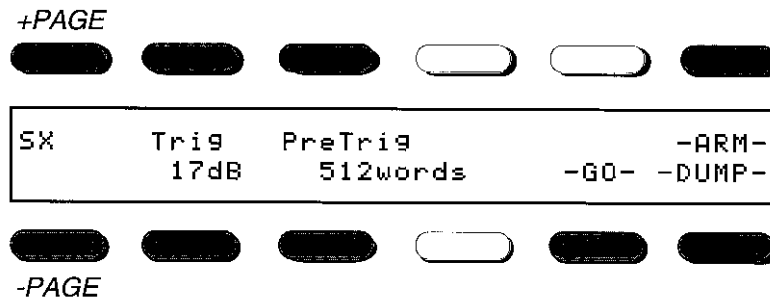

Trig

Adjusts the “trigger” threshold. The threshold can be adjusted to any value from 42 dB to 00 dB below the “clip” level of the sampler. The default “trigger” threshold is 30 dB below the “clip” level.

PreTrig

This adjusts the pre-trigger buffer. The pre-trigger buffer is a buffer that automatically begins storing the sample from the moment the *-Arm-* soft button is pressed (or the Arm button on the front panel of the SX) until the trigger condition is met and the sample actually begins recording. Basically this gives you “fade-in” to your sample. The amount (length) of that “fade-in” depends on the size of the pre-trigger buffer.

Note: The pre-trigger buffer will only be filled if enough time elapses between the time the *-Arm-* soft button is pressed and the time that the “trigger” condition is met. With a pre-trigger size of 512 samples (512 w) and a sample rate of 48 kHz, this is approximately 1/100th of a second (.01).

-GO-

Press this to “manually” start the sampling process.

-ARM-

This provides automatic sampling. When the *-Arm-* soft button is pressed, the sampling process will begin with the predetermined “trigger” method.

-DUMP-

Press this to transfer the sample from the SX to the DPM.

6. After pressing either the *-Go-* or *-Arm-* soft button, the following display will appear, indicating that the sampling process has been initiated.

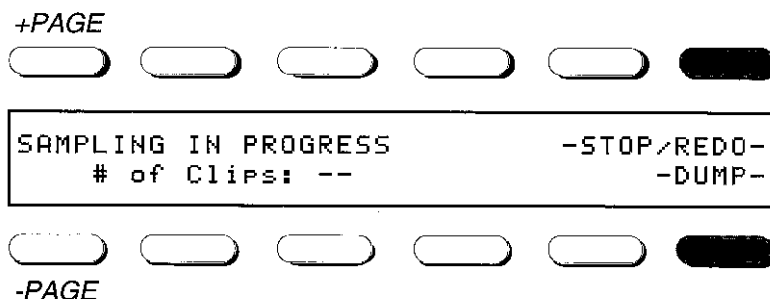

7. After the sampling has completed, the following display will appear:

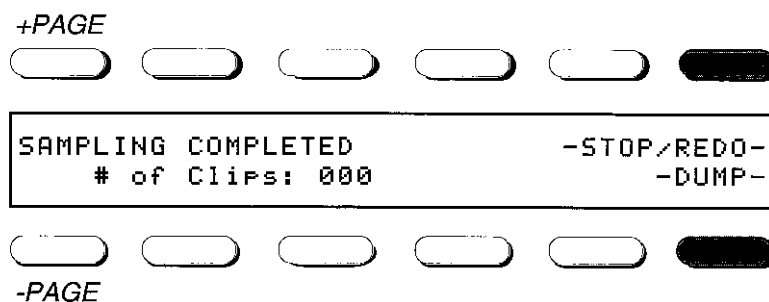

From this display, you can determine whether the sound sample suffered from any “clipping.” The total number of times that the signal was clipped is represented by the “# of Clips: 000” field. This number of times that the “clip” indicator flashed on the SX. If you want to try again, simply press the *-Stop/Redo-* soft button and the DPM will return to the SX setup display.

At this point the sample resides in the SX sample memory. It can now be transferred to the DPM for editing and playing.

From any of the three menus, a “dump” of the most recent sample can be requested by pressing the *-Dump-* soft button on the DPM. When this button is pressed, the MIDI SDS Receive display is presented.

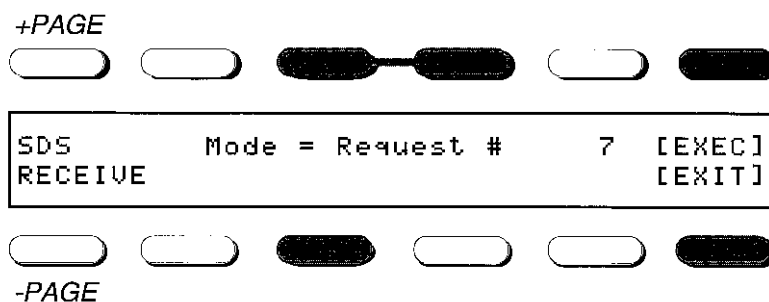

The Request # is the first available empty location (7 in our example). If this is okay press the **[EXEC]** soft button. If you want to change the location press one of the soft buttons above “Request #” and change the location number for the sample. To abort press the **[EXIT]** soft button.

7.14b RCV (Receive a Sample from an SX II)

Note: Receiving samples from the SX II is the same as the SX therefore only the setup (display) differences will be shown.

The following procedure requests a sample from an SX II and loads it in RAM.

1. Connect the MIDI cabling as described earlier.
2. Press the **MIDI** System button. Select the base channel over which you want to transfer the sample by pressing the *InCh* soft button and selecting the desired channel. Press the *Mode* soft button and select Omni or Poly mode.
3. Press the **Global** System button and press the *-Sample Ram-* soft button.
4. Press the *Rcv* soft button. The display shows something like (SX II screen):

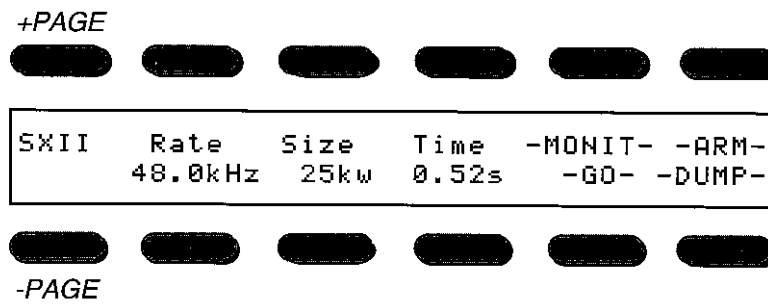

Rate

This lets you select the sample rate. Choose from 16 kHz, 24 kHz, 32 kHz, 38.4 kHz (sample rate for the DPM), 44.1 kHz (sample rate for DPM SP) and 48 kHz.

Size

Selects the size of the sample. This ranges from 1 kiloword to the maximum available (unused) memory. Notice that when you change the size of the sample the time parameter also changes to reflect the number of seconds the sample will use.

Time

Selects the length of the sample. The smallest interval for capturing a sample is .02 seconds. The largest interval depends on the amount of memory available as well as the sample rate selected. The higher the sample rate the less time you have to capture your sample. For example, at a sample rate of 48 kHz with 1 megabyte of memory, the total sample time is approximately 11 seconds (for a mono sample).

-MONIT-

The Monitor feature allows you to hear exactly how the sample is going to sound (at the selected sample rate) before it is recorded. The Monitor feature works in real-time. This means that you can change the input level(s) and/or the sample rate and immediately hear what affect it will have on the sample.

-ARM-

The *-Arm-* soft button places the SX II in a “standby” mode, waiting for any one of the several “trigger” signals to initiate the sampling process. When the *-Arm-* soft button is pressed the LED directly above the Arm button on the SX II will begin to flash, indicating that the sampler is “armed” and ready to sample.

-GO-

Press this to “manually” start the sampling process.

-DUMP-

Press this to transfer the sample from the SX II to the DPM.

5. Press the *+Page* (or *-Page*) button to access the second page of the SX II screens.

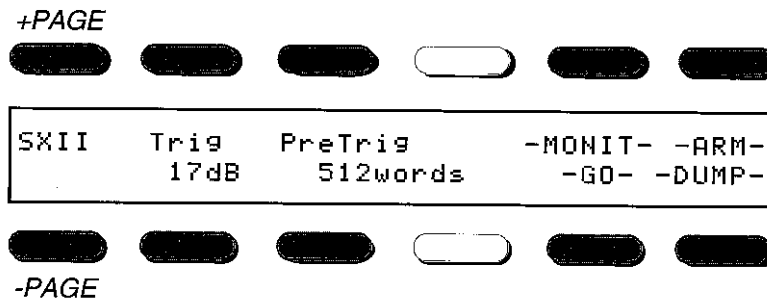

Trig

Adjusts the “trigger” threshold. The threshold can be adjusted to any value from 42 dB to 00 dB below the “clip” level of the sampler. The default “trigger” threshold is 30 dB below the “clip” level.

PreTrig

This adjusts the pre-trigger buffer. The pre-trigger buffer is a buffer that automatically begins storing the sample from the moment the *-Arm-* soft button is pressed (or the Arm button on the front panel of the SX II) until the trigger condition is met and the sample actually begins recording. Basically this gives you “fade-in” to your sample. The amount (length) of that “fade-in” depends on the size of the pre-trigger buffer.

Note: The pre-trigger buffer will only be filled if enough time elapses between the time the *-Arm-* soft button is pressed and the time that the “trigger” condition is met. With a pre-trigger size of 512 samples (512 w) and a sample rate of 48 kHz, this is approximately 1/100th of a second (.01).

-MONIT-

The Monitor feature allows you to hear exactly how the sample is going to sound (at the selected sample rate) before it is recorded. The Monitor feature works in real-time. This means that you can change the input level(s) and/or the sample rate and immediately hear what affect it will have on the sample.

-ARM-

This provides automatic sampling. When the *-Arm-* soft button is pressed, the sampling process will begin with the predetermined “trigger” method.

-GO-

Press this to “manually” start the sampling process.

-DUMP-

Press this to transfer the sample from the SX II to the DPM.

6. After pressing either the *-Go-* or *-Arm-* soft button, the following display will appear, indicating that the sampling process has been initiated.
7. Continue following the steps listed in section 7.14a to transfer the sample to the DPM.

7.15 SAMPLE MEMORY MANAGEMENT TIPS

Although loading in new samples provides a great deal of sonic freedom, with added features comes the potential for added confusion. This section will hopefully dispel some of that confusion, as well as offer tips on how to use the DPM efficiently.

7.15a Sample Time Trade-offs

One of the trade-offs with any sampling system is sample time versus fidelity. Because of this trade-off, it makes sense to implement two different strategies for using samples. For song writing purposes, where the DPM often serves as a multitimbral module driven by either its onboard sequencer or an external sequencer, fidelity is not as important as having a wide variety of samples available. This calls for a large collection of short samples so that as many as possible can reside in memory at the same time. Saving this set to disk (using the Save All function in the -Sample RAM- menu) not only provides backup, but lets you reload the set when needed.

7.15b The Sample/Patch Program Relationship

You'll probably develop some special patch programs around the samples you load, but *it's vital to understand how DPM patch programs use samples*. When you select a sample for a DPM wave, it finds that sample not by name, but by the position in memory. For example, suppose you clear sample memory, then load in a guitar sample followed by a marimba sample. The guitar will be the first sample loaded into memory, and the marimba, the second. Any patch programs using these samples will reference them according to their position in memory. Therefore, if you clear sample RAM but this time load in the marimba first and then the guitar, your guitar patches will now reference the first sample stored in memory (marimba), and the marimba patches will reference the guitar samples.

The easiest way to deal with this situation is to use a consistent set of samples and patch programs using those samples. One option is to keep patches based on internal ROM sounds in a cartridge (DPM 4), and load patches based on samples into internal memory as needed from the disk drive.

7.15c The DPM as Sampler

The traditional difference between samplers and synthesizers is that synthesizers offer a greater number of sounds, but these are relatively inflexible. Samplers, on the other hand, tend to store a lesser number of sounds but these can be any sounds you want. The DPM works similarly, although in this case, both types of operation "live" in one unit.

Although using lots of short samples works best when using the DPM as more of a synthesizer, sometimes you'll want to opt for sound quality over quantity (i.e., doing overdubs of specific instrument sounds) and treat the DPM as more of a sampler. In these instances, it makes sense to load in a smaller number of longer samples.

Since this involves working with only one basic sound at a time instead of the many different sounds typical of multitimbral operation, it's best to keep the samples and associated patches on one disk. When it's time to load that disk, clear the sample RAM and load in the samples, then load the programs and (if applicable) effects. In this situation, the DPM becomes dedicated to producing as high a quality sound as possible from a single sample or group of samples.

7.15d Additional Tips

Get into the habit of saving collections of samples and patches on disk. It only takes a few seconds to load sounds; you'll probably end up treating the DPM memory not as something sacred, but simply as a holding tank for whatever gets stuffed in from the disk drive.

RAM expansion is also an issue, since just like computers, samplers can never have enough RAM. Extra RAM is not cheap, but it's worth it if you can afford it. The stock 64K of RAM that comes with a DPM is better than nothing, but you'll be limited to a very small collection of samples. Certainly no sampler on the market uses this little memory, and if you want your DPM to act like a sampler, you'll probably want to give it the memory to think like one.

Chapter 8: Advanced Applications

8.1 MIDI OVERFLOW MODE

Overflow chains two DPMs together to double the number of voices from 32 to 64 (or chain three DPMs for 96 voices). If the first DPM in the chain runs out of voices, it assigns any “overflow” notes to the next DPM in the chain rather than steal its own voices. Note that the DPM V3 rack-mount is ideal as a second sound generator.

To access overflow mode:

1. Load the same programs into all DPMs being used and run their outputs into a mixer. Make sure all DPMs are in POLY mode and tuned to the same MIDI channel.
2. Connect the first DPM's MIDI Out to the second DPM's MIDI In.
3. If using a third DPM, connect the second DPM's MIDI Out (not MIDI Thru!) to the third DPM's MIDI In.
4. Press the **MIDI System** button on the first DPM. The display shows:

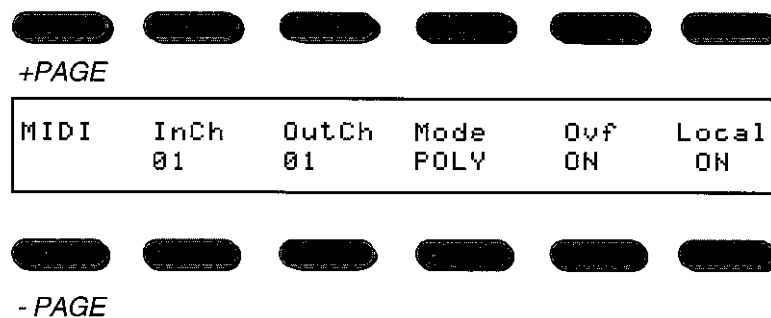

5. Press the *Ovf* soft button and select ON.
6. Perform steps 4 and 5 for the second and (if present) third DPMs.

8.2 ALTERNATE TUNING TABLES

The even-tempered scale used in most western music is a comparatively recent invention; prior to that other types of tuning predominated, and non-even-tempered scales are still used in many parts of the world.

The even-tempered scale is optimized for harmonically complex music that modulates a lot. This is because the even-tempered scale divides an octave so that multiplying any one frequency by the twelfth root of 2 gives the frequency of the next higher-pitched semitone. Since the pitch difference ratio between each semitone is constant, transposition is easy to do.

The only problem is that the twelfth root of 2 is an irrational number. Without going into a lot of complicated math, this means that the even-tempered scale contains small tuning errors compared to theoretically “perfect” scales, such as just intonation. Just intonation bases its tuning on ratios of whole numbers, with an implied preference for small number ratios such as 3:2, 5:6, etc.; this insures that all notes within a given scale are perfectly in tune with each other. However, for reasons beyond the scope of this manual, transposition into keys other than the one for which a just tuning is optimized can create

intervals that are audibly out of tune.

Prior to the days of computers, cultures that used just intonation tended to stay within a particular key due to the difficulties of modulation. Considering that it is now possible to shift pitch electronically via transposition, this is no longer as much of an issue. *Example:* Suppose you set up a program in just intonation. You can play in the key of C and have perfect intonation. To modulate, copy the program to another program and transpose it to the key to which you want to modulate. When you want to modulate, select the copied program, but *continue playing as if you were playing in the key of C*. You could use a sequencer to send out program changes that select different programs, hence different modulations, as you play.

Alternate tuning is considered one of the final frontiers of contemporary music making. Some people feel that purer forms of tuning, such as just intonation, are more beneficial to the mind and body than even-tempered intervals, which are inherently out-of-tune and therefore grate—albeit subconsciously—on the ear/brain combination. Is this just hype? Or did we really lose an important element of music by adopting the even-tempered scale? Experiment and draw your own conclusions.

The DPM includes three common alternate tuning and two user-defined scales.

For more information on alternate tuning, refer to the following books:

Lou Harrison's Music Primer (Harrison, Lou; C.F. Peters Corp., 1971)

On the Sensations of Tone (Helmholtz, Herman; Dover, 1954)

Genesis of a Music (Partch, Harry; Da Capo Press, 1974)

There is also a newsletter, *1/1*, published by the Just Intonation Network. For a free sample issue, write to JIN, 535 Stevenson St., San Francisco, CA 94103.

8.2a Selecting a Preset Tuning Table

1. Press the **Global** System button.
2. Press the *-Tune-* soft button. The display shows:

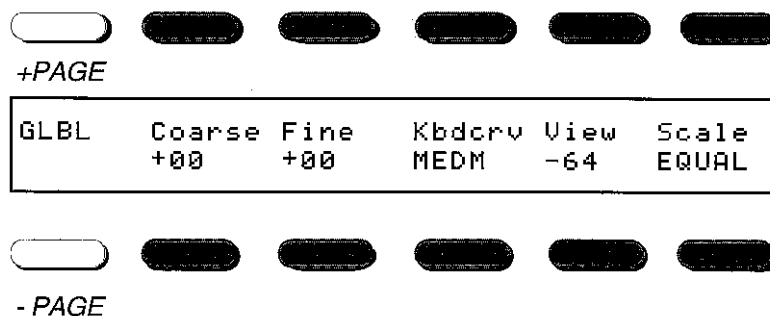

3. Select the desired scale type:

- EQUAL (even-tempered)
- JUSTMaj (major scale just intonation)
- JUSTMin (minor scale just intonation)
- MEAN C (mean tone tuning, key of C)
- USER1 or USER2 (these are user-programmed scales; see next section).

To hear the difference between just and even-tempered scales, play an interval of a third or sixth with the Equal scale type. Now play the same interval using JustMaj. It will probably sound out of tune at first, but listen for a while then switch back to Equal; this scale will now sound out of tune, because its third and sixth are slightly sharp compared to their theoretically optimum value.

8.2b Creating Your Own Tuning Tables

You can also create two custom tuning tables for particular scales (such as Indian ragas). These scales are retained in memory, even if power is turned off.

1. Press the **Global** System button.
2. Press the *-Tune-* soft button. The display shows:

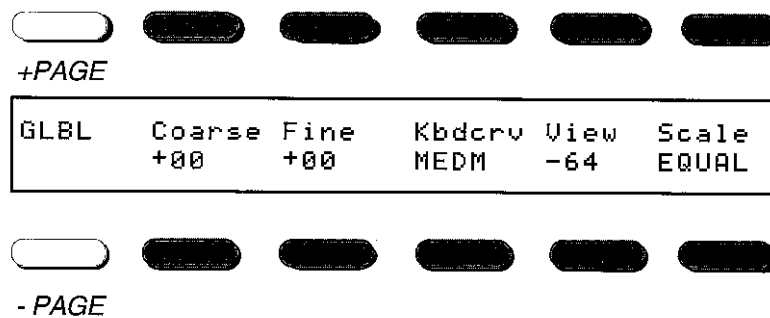

3. Press the *-Page* soft button. The display shows:

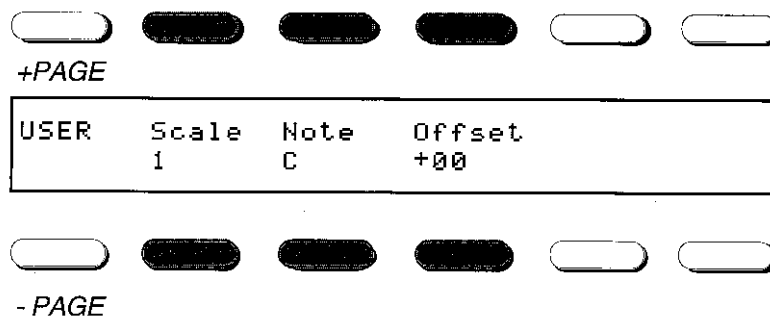

4. Select the scale you want to program, 1 or 2.
5. Press the *Note* soft button, then select the note to be tuned (within a one-octave range, C to B). The tuning specified in this octave is repeated in other octaves.
6. Press the *Offset* soft button, then select the amount of de-tuning (-99 to +99 cents)
7. Repeat steps 5 and 6 until all notes of the octave are tuned as desired.

8.2c Alternate Even-Tempered Tuning

In addition to the options mentioned above, it is possible to program the DPM for alternate even-tempered tuning that include different numbers of notes per octave (e.g., quarter-tone scales). These types of scales may not sound “melodic,” but they are very helpful when creating sound effects—after all, car crashes and door slams are rarely equal-tempered. On the other hand, a 17-tone scale can be musically useful, assuming you find some comfortable keyboard mapping for it.

The key to this technique is to use KEYBOARD as the wave modulation source and scale it appropriately. Make sure that the tuning table is set to EQUAL (section 8.2a). Here are some possibilities:

1/4 Tone Tuning Set Wave pitch modulation to KEYBOARD and amount to -50. Set Fine pitch to +50. Setting Coarse pitch to -02, +10, or +22 puts C on the lowest key.

1/8 Tone Tuning Set Wave pitch modulation to KEYBOARD and amount to -75. Set Fine pitch to +75. Setting Coarse pitch to -09, +3, or +15 puts C on the lowest key.

17-Tone Tuning Set Wave pitch modulation to KEYBOARD and amount to -29. Set Fine pitch to +12. Setting Coarse pitch to +11 puts C on middle C; an octave spans from middle C to F above middle C.

Non-Transpose Mode In non-transpose mode, any key plays the same note. This is handy for some sound effects applications. To do this, set Wave pitch modulation to KEYBOARD and amount to -99. All other modulation should be OFF.

8.3 MIDI SYSTEM EXCLUSIVE STORAGE

Many MIDI devices (synthesizers, signal processors, etc.) can save their parameter settings and patches as MIDI system exclusive data. With devices that do not have onboard disk drives, system exclusive storage is often a more reliable and/or cost-effective way to save data compared to using RAM cartridges or a cassette interface.

The DPM can store system exclusive messages (64K or less) from other MIDI devices. These are read into the DPM's memory, at which point they can then be saved to disk as a file. Later on, this file can be loaded into the DPM, then played back into devices that can accept the system exclusive data (usually, this is the device that initially generated the SysEx dump).

8.3a Saving SysEx Data to the DPM

This procedure sets up the DPM to accept a system exclusive dump from another piece of gear, and either save the data to disk or send it to another piece of gear.

1. Connect the source device's MIDI Out to the DPM's MIDI In.
2. Press the **Copy** system button.
3. Press the *-Midi/Cart/Int-* soft button.
4. Press the *Copy* soft button.
5. Select **SysXIn**. Press the [ENTER] button.
6. The display will indicate that the DPM is waiting for a system exclusive dump from the source device. Initiate a system exclusive dump; read the source device's manual to find out how to do this.
7. The display will count the number of bytes received. After the number stops, press the **-Stop-** soft button.
8. The system exclusive message is now in the DPM's memory. You have two choices:
 - To immediately resend this to another device, connect the DPM's MIDI Out to the destination device's MIDI In. Select **SysXOut**, then the *-Send-* soft button. The bytes will count down to zero; after sending the SysEx data, the DPM will return to the MIDI mass storage main screen.
 - To save to disk, press the **Copy** system button, the *-Midi/Cart/Int-* soft button, the **Copy** soft button, the *-Save-* soft button, then the *-SysEx-* soft button. You will now have a chance to name the file before

saving it to disk. After naming, press the **-EXEC-** soft button and the SysEx data will be saved to disk.

If you turn off the DPM before saving the SysEx data to disk, that data will be lost!

8.3b Reloading and Sending SysEx Data from the DPM

This procedure loads a DPM-format SysEx file from the DPM disk drive disk into memory, whereupon it can be transmitted to a device that accepts the particular type of SysEx data.

1. Connect the DPM's MIDI Out to the destination device's MIDI In.
2. Press the **Copy** system button.
3. Press the **-Midi/Carl/Int-** soft button.
4. Press the **Copy** soft button.
5. Press the **Load** soft button.
6. Press the **-SysEx-** soft button. The DPM will search the disk for SysEx files.
7. If SysEx files are present on the disk, you can scroll through the catalog of files with the **-Next-** and **-Prev-** soft keys. When the display shows the file you want to load, press **-EXEC-**. If you change your mind, press **-EXIT-**.
8. The SysEx file now resides in DPM memory. To send it to the destination device:
9. Press the **Copy** system button.
10. Press the **-Midi/Carl/Int-** soft button.
11. Press the **Copy** soft button.
12. Select **SysXOut**. Press **Enter**.
13. The display will indicate that the DPM is ready to send a system exclusive dump to the destination device. Press the **-Send-** soft button to transmit the SysEx data.
14. The bytes will count down to zero; after sending the SysEx data, the DPM will return to the MIDI mass storage main screen.

8.4 ATTENTION SOFTWARE HACKERS!

To obtain a listing of the MIDI system exclusive codes used in the DPM, send a self-addressed, stamped envelope to:

Attn. DPM MIDI code
Peavey Electronics Corporation
711 A Street
Meridian, MS 39301

Chapter 9: Programming Tips and Background Material

9.1 SEQUENCING BASICS

The DPM can be driven by a sequencer, or serve as a master sequencer that triggers its own sounds and/or other MIDI instruments. To understand either application, it's necessary to consider how sequencing works.

Sequencing, the computerized equivalent of tape recording, is a very common and popular MIDI application. There are three main types of sequencers: dedicated hardware units, software-based sequencer programs that run on a computer, and onboard sequencers built into keyboards. (Regarding computers, at present only the Atari ST series and Yamaha C1 computers have built-in MIDI connections, but other computers can hook up to a "black box" called a MIDI interface, which converts MIDI data into a format the computer can understand. This allows the computer to control a group of MIDI instruments.)

Sequencing takes advantage of the fact that MIDI data correlates to a performance on a MIDI instrument. The DPM's onboard computer acts like a tape recorder, but instead of recording audio, it stores digital data that represents the notes (and controllers) you played, and the timing with which you played those events.

When driving other instruments from the DPM, all data is transmitted over the MIDI output in a *serial* manner (i.e., one right after the other). Fortunately, this happens at a very high rate, so that notes played at the same time appear to occur simultaneously.

Once stored in memory, reading the data out of memory recreates the performance. The principle is the same as a player piano, but instead of triggering keys based on holes in a roll of paper, electronic sounds within the keyboard are triggered by data contained in the computer's memory. This underscores the importance of MIDI's standardization, since any MIDI-compatible device, not just the DPM's internal voices, can accept data from the DPM. If the sequencer says "play middle C," any sound generator being driven will play middle C (assuming it's not programmed to transpose or otherwise alter the note data), regardless of the manufacturer. However, note that not all instruments implement all aspects of the MIDI specification. For instance, not all instruments send or receive keyboard pressure data.

Each of MIDI's 16 available channels can carry a unique set of MIDI data. Since all this data travels over one cable, each piece of data includes its own channel ID so that MIDI receivers can "tune in" to a particular channel and accept only that data. The DPM's MULTI mode allows different sounds to be tuned to different channels when receiving MIDI data.

When transmitting MIDI data, each sequencer track can be assigned to transmit on a specific channel. For instance, if a track is set to channel 2, all of its data will be stamped as belonging to channel 2. This is particularly helpful, since each recorded "track" can be assigned to a unique MIDI channel, and the associated pieces of gear can tune in to a particular track. *Example:* If track 1 (set to MIDI channel 1) carries bass and track 2 (set to MIDI channel 2) contains drum data, you would set a bass sound

generator to receive channel 1 data and the drum machine to receive channel 2 data.

9.2 ABOUT ENVELOPE GENERATORS

An envelope generator provides a modulation signal that varies over time. Applying it to different modulation destinations produces different results. *Example:* Sending the envelope to a DCA creates changes in level. If the amplitude decays over time, percussive effects (plucked strings, drums, etc.) will result; brass, woodwind, and some bowed instruments have amplitudes that increase over time. A note-on message triggers each envelope.

The DPM's envelope generators (ENV1, ENV2, ENV3, and ENV4/AMPENV) have four pages of parameters and are virtually identical, so we only need to cover how one envelope generator works. All envelopes have five Level and four Time parameters; however, one of ENV4's levels is not variable (as explained later).

The Time parameter sets the transition time from one Level to another. Levels and Times range from 0 (minimum level or time) to 99 (maximum level or time).

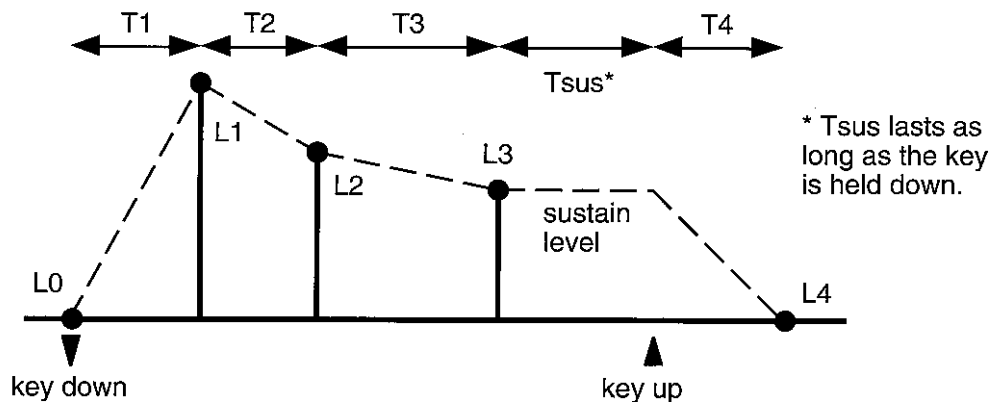

In the example above, L0 is set to 0. T1 determines how long it takes for the level to change from L0's setting to L1's setting. T2 determines how long it takes for the level to change from L1's setting to L2's setting. T3 determines how long it takes for the level to change from L2's setting to L3's setting.

L3 sets the sustain level. This level remains as long as a key is held down.

Releasing the key kicks T4 into action. This sets the time for the sound to change from L3's setting to L4's setting. Since Env 4 determines the overall dynamics by controlling AMPENV, L4 is fixed at 0 so that a note will always eventually decay to 0 (no sound). Otherwise, it would be possible to have notes that never shut off.

Setting different levels and times produces different envelope shapes, described next.

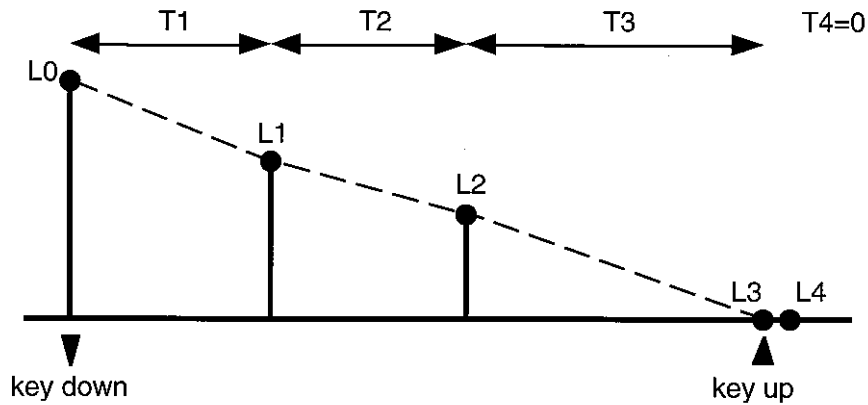

This percussive envelope decays for as long as you hold a key down. The envelope starts at the maximum, decays for time T1 to L1, decays for time T2 to L2, then decays for time T3 to L3. Because L3=0, there is no sustain time. Because T4=0, there is no release time if you lift your finger off the key before the decay has occurred. For most percussive sounds, you'll want to add some release time. Typical L values (0-4): 99, 40, 20, 00, 00. Typical T values (1-4): 09, 09, 24, 00.

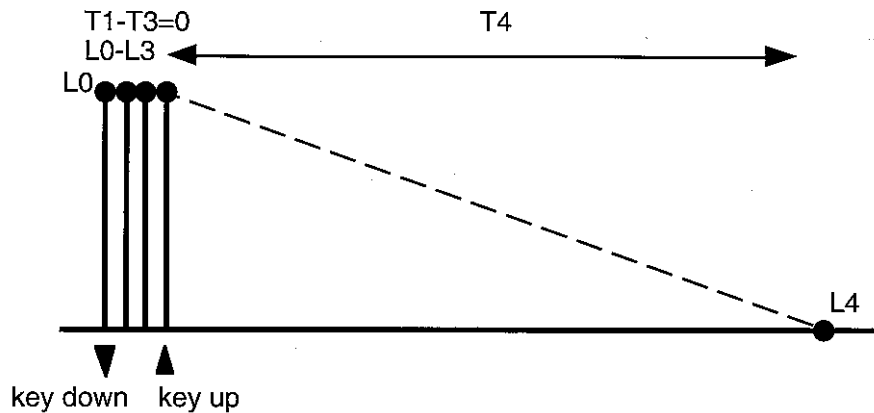

This is a different type of percussive envelope in that all you need to do is tap a key; the note will decay regardless of whether or not you keep your finger on the key. This is useful when synthesizing "struck" sounds, since with something like a marimba, you hit the note once and it decays all by itself.

The key to this envelope is setting L0-L3 to 99 and T1-T3 to 0. When you tap a key, the envelope generator instantly jumps to L3, and since the key is also being released instantly, the release phase immediately starts and lasts for time T4.

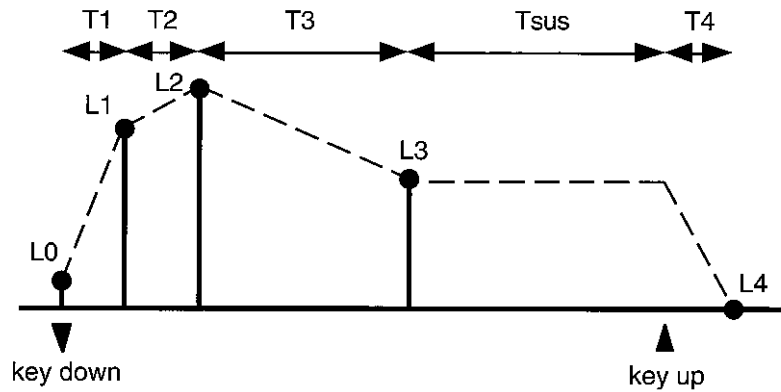

Above is a typical wind instrument envelope. It starts at a low level then rises over times T1 and T2 to a maximum level set by L2. Then there's a slight decay to L3, which sets the sustain level (sustain is needed here because a wind instrument will sustain for as long as you blow into it). Releasing the key brings in a slight release time. Typical L values (0-4): 10, 80, 99, 49, 00. Typical T values (1-4): 03, 03, 35, 03.

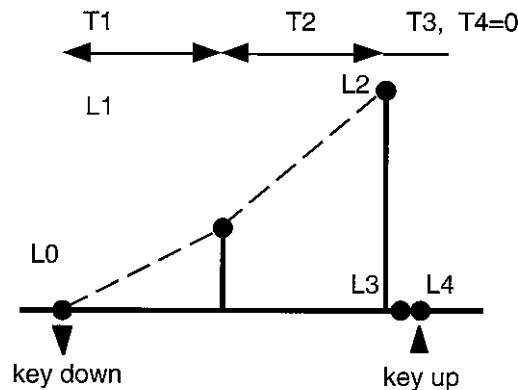

Here's a "backwards tape effect" envelope. As long as you hold down a key, the note will increase in level until it reaches L2. Since T3=0 and L3=0, immediately after reaching L2 the envelope will go down to 0 and stay there. Setting T4 and L4=0 insures that there won't be a release time if you release your fingers from the keys before the envelope reaches L2. Typical L values (0-4): 00, 33, 99, 00, 00. Typical T values (1-4): 15, 20, 00, 00.

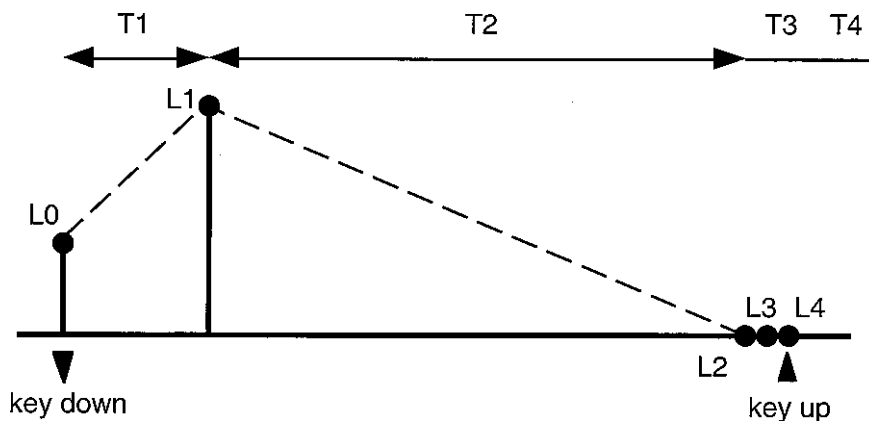

This envelope is useful for bowed effects (such as cello) where you may want an attack time, yet also

want to retain the initial “scrape” of the bow against the strings. Setting L0 at a value other than 0 lets the envelope start at whatever level you want; the rest of the envelope decays slowly back to 0 for as long as you hold the keys down. Typical L values (0-4): 56, 99, 00, 00, 00. Typical T values (1-4): 20, 36, 00, 03.

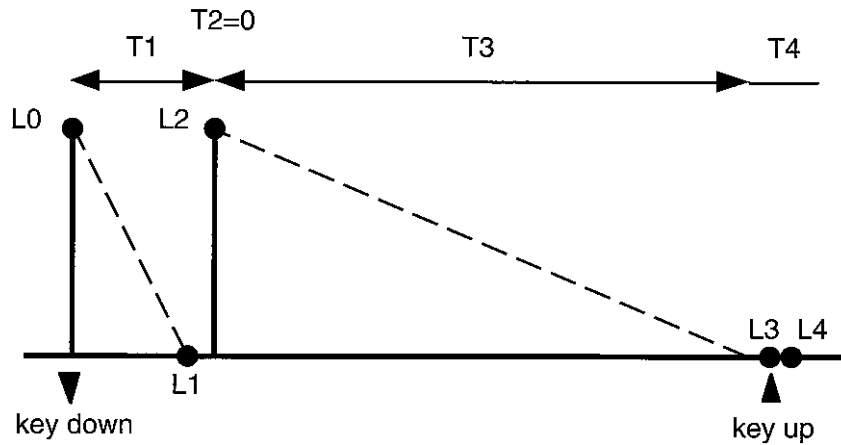

This final example shows an unusual “echo” envelope. The envelope decays from full down to 0, but then does another decay from full down to 0. Increasing T2 would create more of a tremolo effect. Typical L values (0-4): 99, 00, 99, 00, 00. Typical T values (1-4): 02, 00, 15, 00.

9.3 CROSSFADE SYNTHESIS TECHNIQUES

9.3a Automatic Crossfading

Crossfade synthesis techniques create complex sounds by using envelopes to crossfade between two waves. For example, you can set Wave1 for an attack transient with a fast decay and Wave2 for a sustained sound with a slow attack, so that the transient fades out as the sustained sound fades in. If you fade out and fade in times match, the sound will make the transition smoothly from one sound to another.

One common application is to use an acoustic instrument transient and synthesized sustain, such as a cello scrape crossfading with a sawtooth wave, or a flute breath transient crossfading with a triangle wave.

9.3b Manual Crossfading

To manually crossfade between two waves, use negative modulation with one DCA and positive modulation with the other. *Example:* Set Wave1’s level to 00, DCA1’s modulation to WHEEL, and DCA1’s modulation amount to +99. Set Wave2’s level to 99, DCA2’s modulation to WHEEL and DCA2’s modulation amount to -99. As you rotate the mod wheel away from you, Wave1 will fade in while Wave2 fades out.

9.3c Pressure-Controlled Crossfading

Pressure is excellent for crossfading between two different sounds, such as a straight guitar sound and a “feedback” guitar sound an octave higher. Assign the same sound to both waves; on DCA1, use PRESS

as a modulator with amount equal to -99 and level equal to 99. On DCA2, use PRESS as a modulator but set the amount equal to +99 and level equal to 0. Increasing pressure will fade out DCA1 and fade in DCA2.

9.4 PROGRAMMING/EDITING TIPS

Here are some techniques that may help spice up your patches. Programming a synthesizer can be lots of fun; go for it! You'll learn much about sound in the process, and your programs will reflect your own unique "sonic signature."

Pressure-controlled pitch Use pressure to modulate the waves in guitar patches when you want to press on the keys and get pitch bending. Use this with acoustic bass patches to give more of a "fretless" feel.

Envelope-controlled pitch effects Adding a slight amount of upward wave pitch bend to wind instrument or vocal patches, either manually with the pitch bend wheel or automatically with a pitch envelope, can increase a sound's realism.

Using velocity with amplitude and filtering It is often not sufficient to use just volume changes to vary a sound's dynamics, since the *timbre* of "real-world" instruments usually changes with different dynamics, as well. Programming a sound so that higher velocity values raise the filter cutoff slightly can create more realistic dynamics.

The advantages of dual LFOs When creating orchestral string patches, remember that in a real orchestra each player's vibrato will be at a slightly different rate. Therefore, modulate one wave with LFO1 set to a particular frequency, and modulate the other wave with LFO2 set to a slightly different frequency. This helps create a more randomized effect.

Volume balancing As you develop a set of patches, you'll probably want them to have similar overall volume levels. Usually the easiest way to adjust this is with the signal processor L parameters.

Creative use of the modulation wheel Just because everyone normally assigns the modulation wheel to LFO amount (for vibrato) doesn't mean you have to be normal. Here are some suggestions on creative mod wheel applications.

- Bring in suboctaves. This is the ticket for monster bass sounds. Assign Wave1 to your primary bass sound and Wave2 to the octave-lower bass sound (you'll probably need to transpose Wave2 down an octave). Set DCA2 to 00 level, modulator to WHEEL, and amount to +99. Rotating the mod wheel away from you will bring in the suboctave but not affect the primary bass sound.
- Tone control. Use the mod wheel to modulate filter cutoff.
- "Ganged" parameters. Remember that you can modulate lots of different things at once—alter filter cutoff, vibrato rate, tremolo amount, or whatever turns you on by moving the mod wheel.
- Note that any of the above applications will also work with footpedal modulation.

Wave "chorusing" Choose the same wave sample for both waves and de-tune them slightly to create a thick "wash" or sound.

Combi "chorusing" Slight de-tuning between identical programs assigned to different layers adds

chorusing and flanging effects (onboard signal processing can also create these kinds of effects). For a superthick chorus sound, de-tune the waves within a program and assign the program to two or more de-tuned Combi layers.

Combi delays In addition to creating echo effects, the Combi link delay function can create sounds with multiple attacks.

Unusual wave combinations Combining different wavesamples can produce novel effects. *Example:* Suppose you want a really deep piano sound; try adding a bass sample, tuned up an octave and at a much lower volume, behind the piano.

Tremolo effects Modulating the DCAs with a triangle-wave LFO signal varies the amplitude cyclically, creating tremolo effects.

Filter keyboard tracking Modulating the filter with the keyboard correlates the cutoff frequency to the note being played on the keyboard. With zero modulation amount, the filter cutoff tracks the keyboard pitch. Thus, if you have a certain harmonic structure when you play one key, playing a different key will shift the filter frequency to maintain the same harmonic structure.

With negative tracking, the cutoff will change at a less than normal rate as you play higher on the keyboard. This is ideal for bass patches since higher notes will be more muted than lower notes. With positive tracking, the filter cutoff will increase at a faster rate than pitch as you play higher up on the keyboard. This works well when you want the lower notes to be muted and the higher notes to really “cut.”

Super Stereo Effects Combis preserve the stereo panning of the patches within the Combi, which allows for some hot stereo effects. To check this out:

1. Create two different single patches that play the right and left versions of a sound (e.g., Strings L and Strings R, with each panned appropriately).
2. Call up Strings L and make it a Combi patch, with Strings R another patch in the Combi. You now have a patch with separate signals in the left and right channels.
3. Try turning on the delay line for one of the sounds, set for 20 to 40 ms. This should spread the stereo even further.

If you don't want to use two separate programs in the Combi, call up a Single program and set it to Combi. Now enter the same program for the second program of the Combi. If you select the output page panning parameter, this will affect only the foundation program (i.e., the first “link” of the Combi) and not the second program. You can make any other modifications you want to the foundation program (set delays, change LFO, etc.). The only catch is that if you save the program, the second program of the Combi will immediately adopt whatever changes you made to the foundation program.

Many of the signal processors can also create stereo effects. With the stereo delay line, try setting each channel to a time that falls in with the beat of the music (e.g., a quarter-note delay and an eighth-note triplet). The sound will bounce back and forth rhythmically, in stereo.

9.5 BLANK “TEMPLATE” PATCHES

When creating programs from scratch, you can save time by reserving some programs as *template* patches—“generic” wind, plucked, percussion, and string patches which provide a point of departure for related programs. *Example:* A generic wind patch can provide a good foundation for sax, trumpet, and similar sounds.

9.6 ABOUT LEVELS AND DISTORTION

Level can be altered at numerous points within the DPM. Each DCA has a level parameter; the envelopes driving the DCA and final amp have variable levels (which also influence the overall volume); and the signal processing section offers several level-setting options to choose the right blend of processed and straight signals.

As with any audio system, carelessly turning up levels may produce overload conditions that result in distortion. If you encounter distortion:

- Lower the overall level with the master volume slider, or lower the output of individual programs. Also, make sure you’re not overloading your mixer or amp; the DPM puts out a pretty hefty signal.
- Lower the signal processing output level parameters (the L parameter, discussed in Chapter 5 on signal processing).
- If distortion still occurs, the final amp may be overloaded. Try lowering the ENV4 (AMPENV) level parameters, as these affect the final amp levels.
- High filter resonance settings can cause distortion. To solve this, reduce the levels of the two wave DCAs to feed a softer signal into the filter, or reduce the amount of resonance.

Unintentional distortion will probably not occur often, but when it does, try some combination of the above remedies. As you become more familiar with the programming process, you will learn how to balance levels to minimize distortion.

9.7 CARE OF FLOPPY DISKS

A floppy disk is a relatively fragile device. Its operation is based on the same principles as standard magnetic audio tape (i.e., signals are recorded as changes in the disk or tape’s magnetic field), except that the disk stores digital data instead of audio.

A disk consists of a thin circular sheet of plastic coated with magnetic material, enclosed in a plastic jacket. The 3.5” disk types used in the DPM feature a durable plastic case, and a “shutter” that protects the magnetic material when not in use (to see the magnetic material, slide the shutter back—but be careful not to touch or damage what you see when you do this!!).

Inserting disks Insert a disk into the DPM drive shutter side first, label side up. Push the disk gently into the drive until it clicks in place, and the small eject button in the disk drive’s lower right corner pops out.

Ejecting disks To eject the disk, press firmly but gently on the eject button. The disk will come partially out of the drive; pull it out the rest of the way manually.

Write-protecting disks Write-protecting a disk makes it impossible to record new data for as long as the disk is write-protected. Locate the small write-protect “slide switch” in the corner of the disk. Open it to write-protect, close for recording.

Protecting the drive During transport, NEVER insert a disk. The floppy disk drive in this equipment has an integral head safety locking mechanism which protects the heads during transportation. If a disk is in the drive while it is being transported the locking mechanism will not work! To prevent damage to the disk drive as well as your disks, do not transport this unit with a disk in the disk drive.

Use double-sided disks only Single-sided disks are not tested for double-sided applications (the DPM drive uses both sides of the disk). Do not use high-density (HD) floppies, as they are optimized for use in an entirely different type of disk drive.

Proper care of disks Because diskettes are similar to audio tape, the same “dos and don’ts” concerning care and usage of audio tape also apply to floppy disks.

- Don’t subject the disk to stray magnetic fields. Placing a disk on or near a speaker, television, transformer, magnet, or other source of magnetic fields may scramble the disk’s data.
- Don’t subject the disk to temperature extremes, especially heat. If a disk gets left out in the sun, the jacket that holds the disk may become warped or deformed. If a disk becomes warped, immediately load it into the DPM and try to make a copy. Crossing your fingers may help...
- Don’t sit on a disk.
- Label your disks. Keeping track of which programs and samples are on which disks can be a hassle, but the only way to get the maximum use out of a disk library is to be able to find the disk you need, when you need it. Note that two different types of labels, permanent and removable, are available at office supply stores. Use the removable types—you’ll find that over time, some disks will get reused, and you’ll want to change the labels.
- Store your disks in a safe place. You can use standard office supply disk holders, or save yourself a few bucks by buying 4” x 6” file card boxes. However, make sure that your disk will fit in the holder before you buy it; some types have a sloping bottom that will not allow disks to fit properly. Another tip is to put a thin sheet of foam on the bottom, as this will hold the disks more securely.

Chapter 10: MIDI Supplement

(This chapter is adapted with permission from *Power Sequencing with Master Tracks Pro/Pro 4* and *The Complete Guide to the Alesis HR-16 and MMT-8*, ©1990 and 1989, respectively, by AMSCO Publications.)

10.1 MIDI BASICS

Most current electronic instruments, including the DPM, contain an internal computer. Computers and music get along very well, which is not surprising considering music's mathematical basis (consider frequencies, harmonics, vibrato rates, tuning, etc.). In the mid-70s, microcomputers became inexpensive enough to be built into consumer-priced musical instruments. They were used for everything from sound generation to storing parameters in memory for later recall.

In 1983, the MIDI (Musical Instrument Digital Interface) specification was introduced to better exploit the computers inside these new musical instruments, primarily to insure compatibility with equipment from other manufacturers. MIDI expresses musical events (notes played, vibrato, dynamics, tempo, etc.) as a common "language" consisting of standardized digital data. This data can be understood by MIDI-compatible computers and computer-based musical instruments.

Before electronics, music was expressed exclusively as written symbols. By translating musical parameters into digital data, MIDI can express not only the types of musical events written into sheet music, but other parameters, as well (such as amount of pitch bend or degree of vibrato).

10.2 MIDI HARDWARE

MIDI-compatible devices usually include both MIDI In and MIDI Out jacks, which terminate in 5-pin "DIN" connectors. The MIDI Out jack transmits MIDI data to another MIDI device. As you play a MIDI controller such as the DPM, data corresponding to what you play exits the MIDI Out jack. *Example:* If you play middle C, the MIDI Out transmits a piece of data that says "middle C is down." If you release that key, the MIDI Out transmits another piece of data that says "middle C has been released." If the keyboard responds to the dynamics of your playing, the note data will include dynamics information, too. Moving the modulation wheels and pedals attached to many synthesizers will also generate data associated with the wheel or pedal being used.

The MIDI In jack receives data from another MIDI device. In addition to the type of performance data described above, rhythmically-oriented MIDI devices (e.g., drum machines) can often transmit and/or receive additional MIDI timing messages that keep other rhythmically-oriented units in a system synchronized with each other.

An optional MIDI Thru jack provides a duplicate of the signal at the MIDI In jack. This is handy if you want to route MIDI data appearing at one device to another device, as well.

Example: Suppose the DPM's MIDI Out feeds the DPM V3 rack-mount's MIDI In. Patching the V3's MIDI Thru to a second V3 sends the signal present at the V3's input "thru" to the second V3. Thus, playing on the DPM will trigger both V3s.

10.3 MIDI MESSAGE BASICS

There are two main types of MIDI messages. *Channel* messages, which are channel-specific, consist of Voice and Mode messages. *System* messages, which do not have a channel number and are received by all units in a system, include Common, Real Time, and Exclusive messages.

10.4 CHANNEL MESSAGES

10.4a Voice messages

A synthesizer's voice is the most basic unit of sound generation. Usually, each voice plays one note at a time (although a DPM voice can consist of two waves), so the number of notes you can play at one time will be limited by the available number of voices. MIDI messages that affect voices include:

Note On Corresponds to a key being pressed down; values range from 000 (lowest note) to 127 (highest note). Middle C is 60.

Note Off Corresponds to a key being released; values are the same as note on.

Velocity Corresponds to dynamics; values range from 001 (minimum velocity) to 127 (maximum velocity). A velocity of 000 is equivalent to a note-off message.

Pressure Indicates the pressure applied to a keyboard after pressing a key; typically used to introduce vibrato, open a filter, etc. There are two kinds of pressure. Mono (or channel) pressure represents the average pressure of all keys held down, whereas polyphonic pressure sends out data for each individual key being pressed down. The DPM responds to Mono pressure only. Values range from 000 to 1210.

Program Change Sending a program change command from a sequencer or other MIDI keyboard can change synth patches automatically. There are 128 program change command numbers.

Pitch Bend This "bends" a note from its standard pitch, which is excellent for creating lead guitar effects. The degree of response to pitch bend sensitivity is adjustable for each DPM program, but to prevent confusion you might want to set them all to the same value.

Continuous Controller Footpedals, breath controllers, and modulation wheels can vary sounds as you play, thus adding expressiveness. MIDI allows for 64 continuous controllers (these act like potentiometers in that you can choose one of many different values) and 58 continuous/switch controllers (these can act like continuous controllers, but some are assumed to choose between two possible states, such as on/off).

Each type of controller is stamped with its own controller identification number. Not all controller numbers have been standardized for specific functions, but the following indicates the current list of assigned controllers. Numbers in parentheses indicate the controller range.

- 1 Modulation Wheel (0-127)
- 2 Breath Controller (0-127)
- 3 Early DX7 Aftertouch (0-127)
- 4 Foot Controller (0-127)

- 5 Portamento Time (0-127)
- 6 Data Slider (0-127)
- 7 Main Volume (0-127)
- 8 Balance (0-127)
- 10 Pan (0-127)
- 11 Expression (0-127)
- 16 General Purpose #1 (0-127)
- 17 General Purpose #2 (0-127)
- 18 General Purpose #3 (0-127)
- 19 General Purpose #4 (0-127)
- 32-63 Least Significant Bits, Controllers 0-31 (0-127)
- 64 Sustain Pedal (0 or 127)
- 65 Portamento On/Off (0 or 127)
- 66 Sustain Pedal (0 or 127)
- 67 Soft Pedal (0 or 127)
- 69 Hold 2 (0 or 127)
- 80 General Purpose #5 (0 or 127)
- 81 General Purpose #6 (0 or 127)
- 82 General Purpose #7 (0 or 127)
- 83 General Purpose #8 (0 or 127)
- 92 Tremolo Depth (0-127)
- 93 Chorus Depth (0-127)
- 94 Celeste Depth (0-127)
- 95 Phase Depth (0-127)
- 96 Data Increment (0 or 127)
- 97 Data Decrement (0 or 127)
- 98 Non-Registered Parameter MSB (0-127)
- 99 Non-Registered Parameter LSB (0-127)
- 100 Registered Parameter MSB (0-127)
- 101 Registered Parameter LSB (0-127)
- 121 Reset All Controllers (0)
- 122 Local Control On/Off (0 or 127)
- 123 All Notes Off (0)
- 124 Omni Off (0)
- 125 Omni On (0)
- 126 Mono On (0-16; 0=Omni Off)
- 127 Poly On (0)

10.4b Mode messages

There are two messages that determine the MIDI mode (i.e., how the DPM will receive MIDI data). The “omni” message determines how many channels will be recognized. Omni on means that data from all channels will be received; Omni off limits the number of channels, usually to one.

The “mono/poly” message deals with voice assignment within the synthesizer. In Mono mode, only one note at a time plays in response to voice messages; in Poly mode, as many voices can play notes as are available to play notes.

Combining these two messages in various ways produces the following mode messages.

Omni On/Poly (Mode 1) The DPM's voices respond to voice messages occurring on any channel.

Omni On/Mono (Mode 2) This mode is seldom implemented because playing one note out of the data occurring on all 16 channels is not real useful.

Omni Off/Poly (Mode 3) In this extremely common mode, the DPM is tuned to a single channel; any incoming messages are assigned to synth voices, up to the maximum number of 16 voices.

Omni Off/Mono (Mode 4) Voice messages are received over several channels, but each channel plays monophonically. In other words, you could play one voice on channel 1, one voice on channel 2, etc. The DPM implements an improved version of Mono mode called Dynamically Allocated Multi Mode, which lets the synth receive *polyphonic* data over each channel.

10.4c Other messages

Local Control On/Off With Local Control on, playing the DPM keyboard triggers the internal voices and sends data out the MIDI Out jack. With Local Control off, the keyboard does not trigger the internal voices but does send data over MIDI Out. The main use for Local Off is to play an expander module from a master keyboard, but not trigger the internal sounds.

10.5 SYSTEM COMMON MESSAGES

Intended for all units in a system, some of these messages are:

Song Position Pointer This indicates how many "MIDI beats" (normally a 16th note) have elapsed since a piece started (up to 16,384 total beats). It is primarily used to allow different sequencers and drum machines to auto-locate to each other, so that if you start one sequencer, the other device will automatically jump to the same place in the song, whereupon both continue together.

System Exclusive This message (called SysEx for short) is considered "exclusive" because different manufacturers send and receive data over MIDI which is intended only for that manufacturer's equipment. *Example:* Sending a Peavey DPM message to an Ensoniq EPS won't do anything but will be understood by other DPMs. This data often contains information about individual instrument patches.

Timing Clock The master tempo source (such as a sequencer) emits 24 timing messages (clocks) per quarter note. Each device synchronized to the sequencer advances by 1/24th of a quarter note when it receives the clock message, thus keeping units in sync after they've both started at the same time. In the case of the DPM, this clock is subdivided internally to a rate of 96 clocks per quarter note to increase the timing resolution.

Start Signals all rhythmically-based units when to start playing.

Stop Signals all rhythmically-based units when to stop playing.

Continue Unlike a Start command, which restarts a sequencer or drum machine from the beginning of a song each time it occurs, sending a continue message after stop will restart units from where they were stopped.

10.6 BOOKS ON MIDI

The preceding does not substitute for reading a good book on the subject of MIDI. For further information, refer to the following:

MIDI For Musicians and *The Electronic Musician's Dictionary* by Craig Anderton; AMSCO Publications. The former was written specifically for musicians with no background in MIDI, and the latter defines terms related to musical electronics.

Music Through MIDI by Michael Boom; Microsoft Press. An excellent text for those just getting started with MIDI, synthesis, and related topics.

The Murphy's Law MIDI Book by Jeff Burger; Alexander Publishing. Emphasizes applications and problem-solving.

Using MIDI by Helen Casabona and David Frederick; Alfred Publishing. A general guide to MIDI with an emphasis on applications.

Understanding MIDI and *Understanding MIDI 2* by various authors; Amordian Press. A collection of MIDI-oriented articles from *Musician* magazine.

These are available from many music and book stores; a mail order source is Mix Bookshelf (800/233-9604).

Index

A

- Alternate Tuning Tables 121–124
- Amplitude
 - keyboard note modulation 50
 - keyboard velocity level 50
 - set base level 49
 - set fx2 send level 50
 - set modulation source and degree 49
 - set stereo pan 50
- Audio Hookup 10. *See also* Cable Setup

C

- Cable Setup 10
- Cartridge
 - copy data from 23–24
 - copy Data to 23–24
 - initialize 30
- Combi. *See* Links
- Crossfading Techniques
 - automatic 130
 - manual 130
 - pressure-controlled 130–131

D

- DCAs 42
- DPM Synthesizer Architecture 41
- Drum Kits
 - accessing 37
 - basics 37
 - modifying 38

E

- Effects
 - chorus 68
 - delay 67
 - differences between effect 1 & 2 62–64
 - distortion 70
 - dual effects options 61
 - EQ 69
 - exciter 71
 - gated reverb 70
 - reverb 66
 - single effects options 61
- Envelopes
 - about envelope generators 127–130
 - keyboard note modulation 53
 - keyboard velocity level 53
 - looping 53
 - set levels 52
 - set times 54

F

- Filters 42–43
 - change initial cutoff frequency 51
 - scale cutoff frequency 51
 - set filter curve 51
 - set keyboard modulation split point 51
 - set modulation source and degree 52
- Floppy Disk
 - care of 133
 - delete files from 28–29
 - formatting 24–25
 - load files from 27–28
 - save files to 25–26
 - characters available 26
- Footpedal Assignment 34
- Footswitch Assignment 34–35

K

- Keyboard
 - initialization 36
 - response 20
 - tuning 19

L

- LFOs
 - select shape 55
 - set delay 56
 - set fade in duration 56
 - set LFO speed 55
 - set modulation source and degree 56–57
 - set signal level 55
- Links 57–58
 - adjust tuning 60
 - set delay amount 60
 - set fx2 send amount 60
 - set key range 59
 - set MIDI channel 60
 - set minimum and maximum note velocities 59
 - set stereo pan 59
 - set volume level 58
 - set volume modulation source and degree 58
 - transpose frequency 60

M

- MIDI
 - basics 135
 - books 139
 - filters 22
 - hardware 135
 - Input Channel 21
 - local control 22
 - messages 136–138
 - mode selection 21
 - output channel 21
 - overflow mode 21, 121

- system exclusive messages 124–125
 - sending 29–30
- Modulation Sources 44
- Multis 18

O

- Oscillators 42. *See also* Waves
- Output
 - set effects signal amounts 57
 - set type (single or combi) 57
 - sett effects signal amounts 57

P

- Pan. *See* Amplitude. *See* Links
- Pattern. *See* Sequence
- Play the Demo 10
- Powering Up 14
- Programs
 - change stereo pan 33
 - change volume level 32–33
 - compare 47
 - editing tips 131–132
 - naming 30
 - saving 30–31
 - set pitch bend 33

S

- Samples
 - available memory 105
 - deleting
 - samples 112–113
 - waves 113
 - editing (loop & trim) 109–111
 - load from disk 103–104
 - receive samples
 - from DPM SX 113–118
 - from DPM SX II 116–118
 - from SDS-compatible devices 105–108
 - transmit samples
 - to SDS-compatible devices 108–109
- Sampling
 - looping & trimming 101–103
 - memory considerations 101, 119
 - multi-sampling 100–101
 - overview 99–100
- Selecting Programs 16
- Sequence
 - assign effect to 79
 - clearing all 79
 - copying 78
 - creating 77
 - deleting 78
 - record 82–85
 - selecting 74
- Sequencer
 - basic operation 73

- setup 76
- Sequencing Basics 126–127
- Song
 - build 96–97
 - clear 96
 - edit
 - change step 98
 - delete step 98
 - insert step 98
 - naming and saving 96
 - select 74
- Step Editing
 - erase and record in step edit mode 95
 - erase in step edit mode 94–95
 - play back a sequence in step edit mode 94
 - recording in step edit mode 94
 - set edit size 93
- System Buttons 14
- System Exclusive. *See* MIDI: System Exclusive Messages

T

- Timbre
 - change dynamics 31–32
 - change overall 31
- Track
 - assign program to 80
 - automate mixdown 81–82
 - configure 80–81
 - editing functions 85–86
 - copy data 87–88
 - delete data 91
 - erase data 86–87
 - insert data 91
 - merge data 92
 - quantize data 90–91
 - scale note velocities 89–90
 - slide data 92
 - transpose data 89
 - set fx2 send amount 81
 - set MIDI output channel 81
 - set volume 81–82

V

- View Angle 20
- Voice Edit Buttons 14

W

- Waveform Reference List 48
- Waves
 - adjust pitch 47
 - select a wave 47–48
 - set modulation source and degree 49
 - set pitch bend response 47–48

IMPORTANT SAFETY INSTRUCTIONS

WARNING When using electric products, basic cautions should always be followed, including the following.

1. Read all safety and operating instructions before using this product.
2. All safety and operating instructions should be retained for future reference.
3. Obey all cautions in the operating instructions and on the back of the unit.
4. All operating instructions should be followed.
5. This product should not be used near water, i.e., a bathtub, sink, swimming pool, wet basement, etc.
6. This product should be located so that its position does not interfere with its proper ventilation. It should not be placed flat against a wall or placed in a built-in enclosure that will impede the flow of cooling air.
7. This product should not be placed near a source of heat such as a stove, radiator, or another heat producing amplifier.
8. Connect only to a power supply of the type marked on the unit adjacent to the power supply cord.
9. Never break off the ground pin on the power supply cord. For more information on grounding, write for our free booklet "Shock Hazard and Grounding."
10. Power supply cords should always be handled carefully. Never walk or place equipment on power supply cords. Periodically check cords for cuts or signs of stress, especially at the plug and the point where the cord exits the unit.
11. The power supply cord should be unplugged when the unit is to be unused for long periods of time.
12. If this product is to be mounted in an equipment rack, rear support should be provided.
13. Metal parts can be cleaned with a damp rag. The vinyl covering used on some units can be cleaned with a damp rag, or an ammonia-based household cleaner if necessary. Disconnect unit from power supply before cleaning.
14. Care should be taken so that objects do not fall and liquids are not spilled into the unit through the ventilation holes or any other openings.
15. This unit should be checked by a qualified service technician if
 - a. The power supply cord or plug has been damaged.
 - b. Anything has fallen or been spilled into the unit.
 - c. The unit does not operate correctly.
 - d. The unit has been dropped or the enclosure damaged.
16. The user should not attempt to service this equipment. All service work should be done by a qualified service technician.
17. This product should be used only with a cart or stand that is recommended by Peavey Electronics.
18. Exposure to extremely high noise levels may cause a permanent hearing loss. Individuals vary considerably in susceptibility to noise induced hearing loss, but nearly everyone will lose some hearing if exposed to sufficiently intense noise for a sufficient time.

The U.S. Government's Occupational Safety and Health Administration (OSHA) has specified the following permissible noise level exposures.

Duration Per Day In Hours	Sound Level dBA, Slow Response
8	90
6	92
4	95
3	97
2	100
1½	102
1	105
½	110
¼ or less	115

According to OSHA, any exposure in excess of the above permissible limits could result in some hearing loss.

Ear plugs or protectors in the ear canals or over the ears must be worn when operating this amplification system in order to prevent a permanent hearing loss if exposure is in excess of the limits as set forth above. To ensure against potentially dangerous exposure to high sound pressure levels, it is recommended that all persons exposed to equipment capable of producing high sound pressure levels such as this amplification system be protected by hearing protectors while this unit is in operation.

SAVE THESE INSTRUCTIONS

Free Manuals Download Website

<http://myh66.com>

<http://usermanuals.us>

<http://www.somanuals.com>

<http://www.4manuals.cc>

<http://www.manual-lib.com>

<http://www.404manual.com>

<http://www.luxmanual.com>

<http://aubethermostatmanual.com>

Golf course search by state

<http://golfingnear.com>

Email search by domain

<http://emailbydomain.com>

Auto manuals search

<http://auto.somanuals.com>

TV manuals search

<http://tv.somanuals.com>