

PVM™ 535N

Unidirectional
Cardioid Dynamic
Microphone

FEATURES:

- Very high sensitivity and output
- Low noise, natural vocal reproduction
- Improved shock mounting lowers handling noise and "mic stand rumble"
- Die-cast alloy housing
- Rugged construction and field serviceable for road use
- Furnished accessories include external foam windscreen, swivel adaptor, sturdy "flite-type" carrying case and 25 foot low Z cable
- Double brazed metal screen
- New wire mesh ultra lightweight diaphragm
- Improved transient response
- Neodymium magnetics
- Super off-axis rejection
- Excellent feedback control

DESCRIPTION:

The PVM™ 535N Neo-Dynamic™ is a unidirectional, cardioid, dynamic microphone which relies on the latest in rare earth magnet technology to achieve maximum output sensitivity. The Neodymium Iron Boron magnet provides much higher magnetic flux than traditional dynamic microphone designs, resulting in an output level usually expected only from condenser microphones -- but without the need for batteries or external power supplies.

The PVM™ 535N has been designed with the vocal performer in mind. A new lightweight diaphragm material has been employed to greatly improve transient response and vocal clarity. The diaphragm material is "super light" but maintains its rigidity to withstand the extreme sound pressure levels of

stage and live performances.

Vocalists who work the microphone close will enjoy the 535N due to its reduced proximity effect, producing smooth, clean low-end without the typical "muddiness" that often occurs as the microphone is moved closer to the source. The frequency response is also tailored for "handheld" vocal applications, producing flat low-end with a slight rise in the upper vocal range where sibilance is important.

Feedback rejection is excellent! A combination of cardioid and supercardioid polar patterns have been merged to produce unmatched vocal reproduction and at the same time keep feedback to a minimum. The PVM 535N exhibits a cardioid polar response in the critical vocal range and a super-cardioid response in the feedback region.

The internal shock mount system is totally new and designed to perform to a new specification level along with the lighter-weight, more sensitive diaphragm. Handling noise is minimized for hand-held applications and the shock system is also designed to reduce the noise of removal from mic clips, mic stand clunks, stage rumbles, etc.

An external foam windscreen is also supplied to provide an extra level of wind noise protection in extreme situations.

ARCHITECTURAL & ENGINEERING SPECIFICATIONS

The microphone shall be a moving coil dynamic with a frequency response of 40 Hz to 16 kHz. The microphone shall have a cardioid polar characteristic typically 20 dB down from the front response. The microphone shall have an output power level of -52 dB where 0 dB = 1 milliwatt per pascal and nominal impedance of 400 ohms.

The microphone shall have non-reflecting, low gloss, black Teflon based paint on a die-cast alloy housing

and a brazed metal screen. The connector shall be a 3-pin XLR equivalent audio type and a swivel adaptor shall be provided to mount on a stand having $\frac{5}{8}$ " 27 thread. The microphone shall have overall dimensions of $5\frac{3}{4}$ " in length and $1\frac{1}{8}$ " in diameter. The microphone shall be a Peavey model PVM™ 535N Neo-Dynamic™ or equivalent.

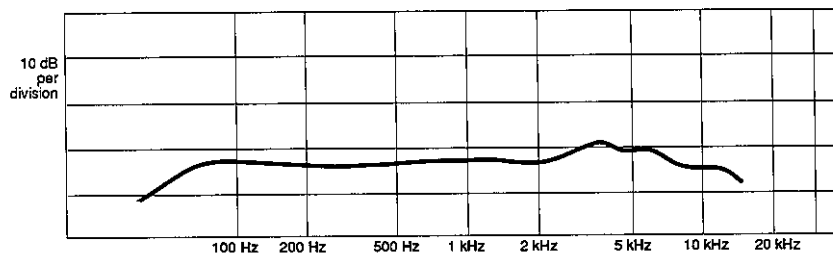
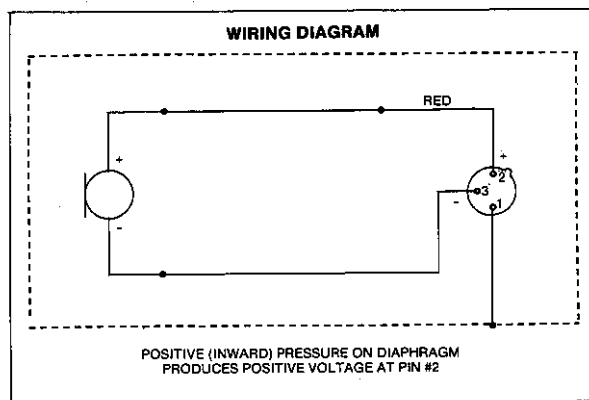
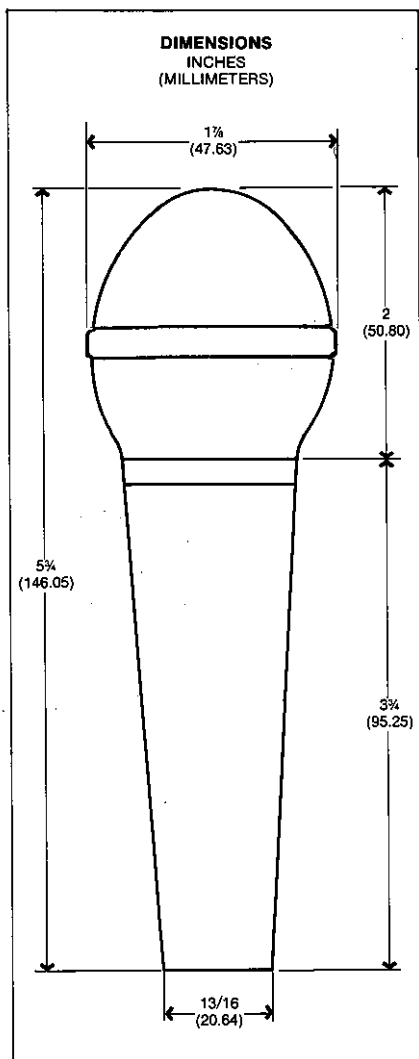

FREQUENCY RESPONSE

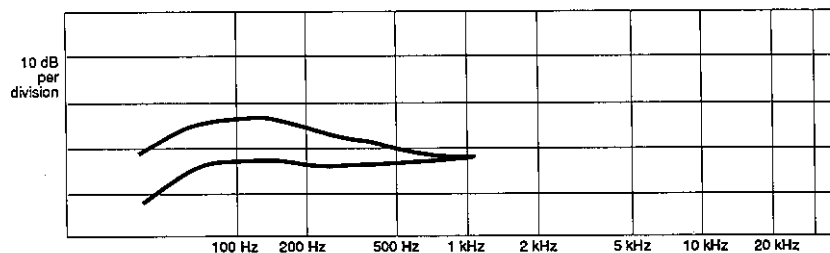

0° & 180° FREQUENCY RESPONSE

Proximity effect is a naturally occurring phenomenon in unidirectional microphones. The effect is to accentuate or boost the low frequency response. This effect is a function of distance from the diaphragm to the source and increases as the diaphragm is moved closer to the source.

POLAR PATTERNS

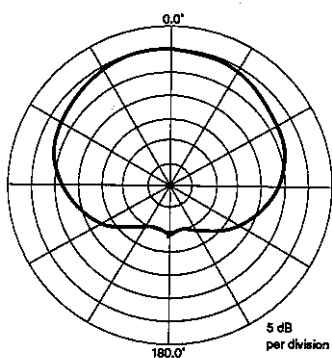

250 Hz

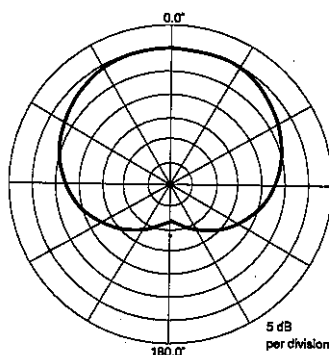

500 Hz

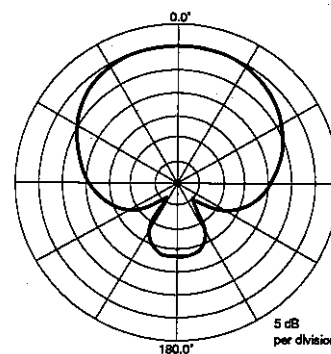

2 K

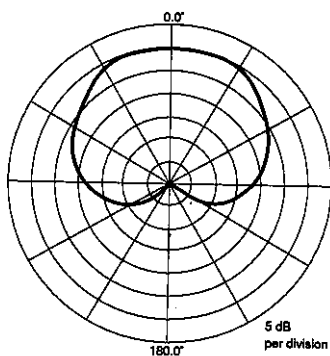

3 K

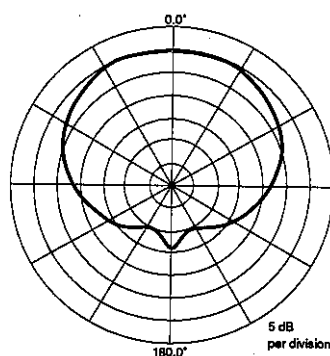

4 K

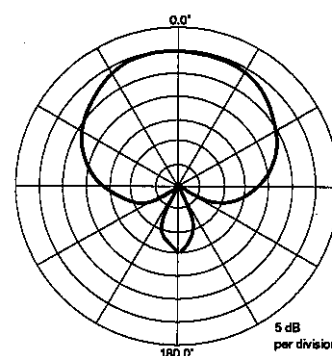

6 K

SPECIFICATIONS:

Element Type:

Dynamic

Magnet Composition:

Neodymium Iron Boron

Polar Pattern:

Unidirectional

Front to Back:

20 dB typical

Impedance:

400 ohms

Frequency Response:

40 Hz to 16 kHz

Sensitivity:

Output Power Level:

-52 dB (0 dB = 1 mW/10 microbar)

Open Circuit Voltage:

-67 dB (0 dB = 1 volt/dyne/cm²)

Case Housing:

Die-cast zinc alloy

Finish:

Low gloss black

Ball Screen:

Brazed steel mesh

Pop Filter:

80 ppi open cell foam (polyurethane)

External Windscreen:

80 ppi open cell foam

Connector Type:

3 pin XLR

Phasing:

Positive (inward) pressure on diaphragm produces positive pulse at pin #2

Weight:

260 grams

Accessories:

Carrying case, swivel adaptor, foam windscreen, 20' balanced line impedance cable with 3 pin and 3 socket XLR equivalent audio connector

*10 microbars = 1 pascal = 10 dynes/cm²

Free Manuals Download Website

<http://myh66.com>

<http://usermanuals.us>

<http://www.somanuals.com>

<http://www.4manuals.cc>

<http://www.manual-lib.com>

<http://www.404manual.com>

<http://www.luxmanual.com>

<http://aubethermostatmanual.com>

Golf course search by state

<http://golfingnear.com>

Email search by domain

<http://emailbydomain.com>

Auto manuals search

<http://auto.somanuals.com>

TV manuals search

<http://tv.somanuals.com>