

SPECS

PEAVEY ELECTRONICS

PVM™ 535i Unidirectional Cardioid Dynamic Microphone

SPECIFICATIONS

Enclosure:

PVM™ 535i

Element Type:

Dynamic

Magnet Composition:

Neodymium Iron Boron

Polar Pattern:

Unidirectional

Front to Back:

20 dB typical

Impedance:

400 ohms

Frequency Response:

40 Hz to 16 kHz

Sensitivity:

Output Power Level:

-52 dB (0 dB = 1 mW/10 microbar*)

Open Circuit Voltage:

67 dB (0 dB = 1 volt/dyne/cm²)

Case Housing:

Alloy

Finish:

Low gloss black

Ball Screen:

Brazed steel mesh

Pop Filter:

80 ppi open cell foam (polyurethane)

External Windscreen:

80 ppi open cell foam

Connector Type:

3 pin XLR type

Phasing:

Positive (inward) pressure on diaphragm produces positive pulse at pin #2

Weight:

200 grams

**Accessories:**

Carrying case, swivel adaptor, foam windscreen, 25' balanced line impedance cable with 3 pin and 3 socket XLR equivalent audio connectors

*10 microbars = 1 pascal = 10 dynes/cm²

FEATURES

- Very high sensitivity and output
- Low noise, natural vocal reproduction

- Tandem tuned electro-mechanical rumble filter dramatically lowers "mic stand" handling noise and rumble
- Rugged construction and field serviceable for road use

PEAVEY®

- Furnished accessories include external foam windscreen, swivel adaptor, sturdy "flite-type" carrying case, and 25' low Z cable
- Double brazed metal screen
- New wire mesh ultra lightweight diaphragm – patented
- Improved transient response
- Neodymium magnetics
- Super off-axis rejection
- Excellent feedback control

DESCRIPTION

The PVM™ 535i Neo-Dynamic™ microphone is a unidirectional, cardioid, dynamic microphone that relies on the latest technologies in rare earth magnets, component design and finishing. Due to the success of the PVM's style, the PVM 535i Series looks like the previous PVM Series, but that is where it stops.

It kept the same style but is totally redesigned inside and out. First, a new

shockmount system that utilizes a tandem tuned mechanical and electrical filter is used to reduce handling noise. The mechanical filter is tuned to resonate at frequencies well below the operating range of the microphone, that allows an electrical circuit to be employed to filter the mechanical signals produced while handling the microphone, the two tuned circuits give the microphone virtual silence while moving it around.

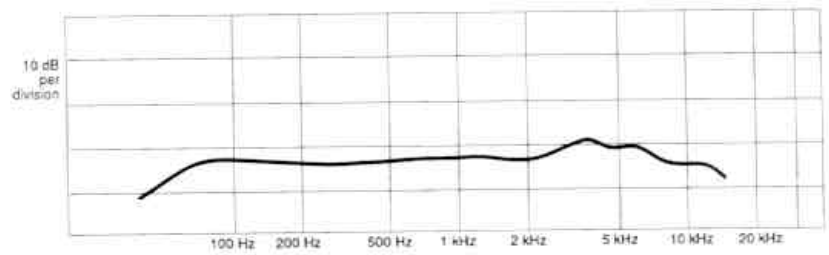
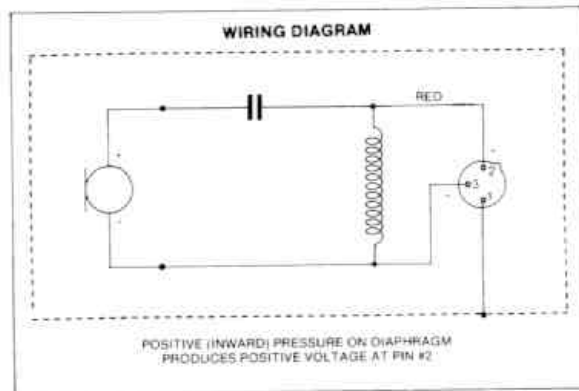
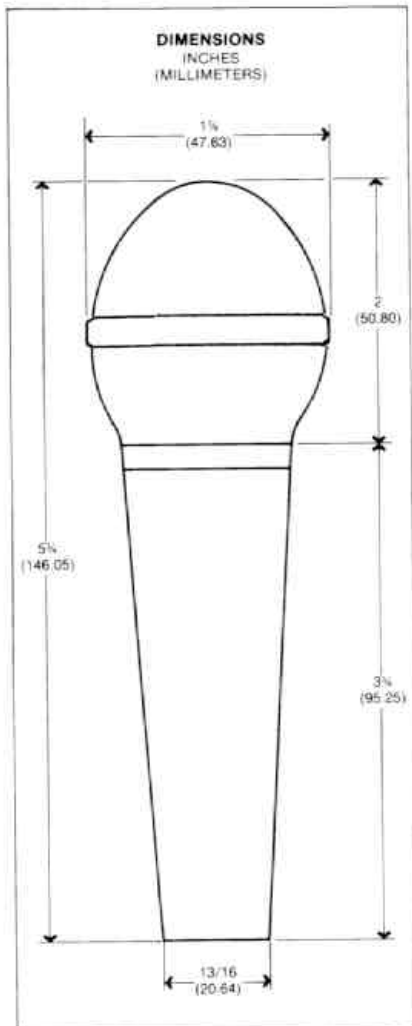

FREQUENCY RESPONSE

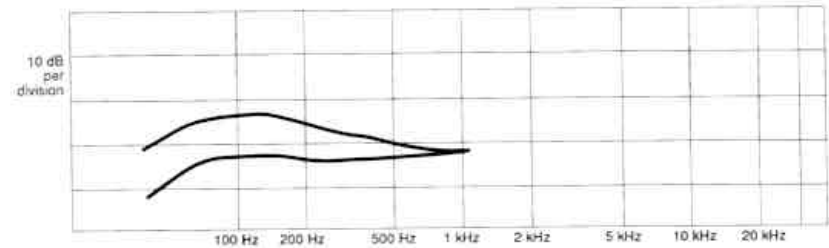

0° & 180° FREQUENCY RESPONSE

Proximity effect is a naturally occurring phenomenon in unidirectional microphones. The effect is to accentuate or boost the low frequency response. This effect is a function of distance from the diaphragm to the source and increases as the diaphragm is moved closer to the source.

POLAR PATTERNS

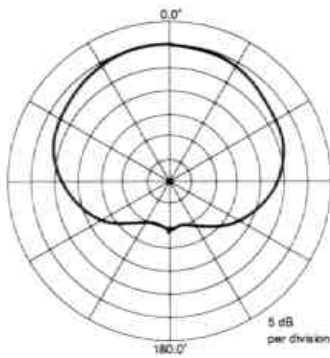

250 Hz

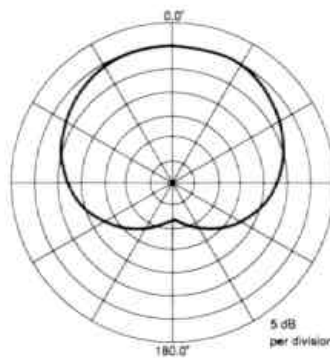

500 Hz

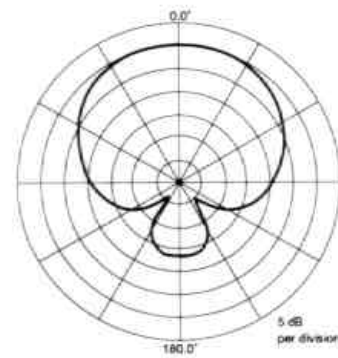

2 K

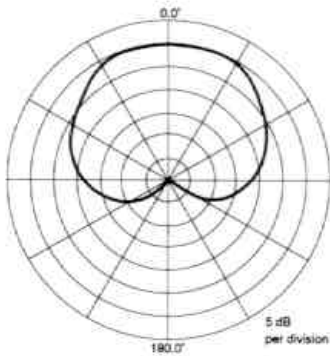

3 K

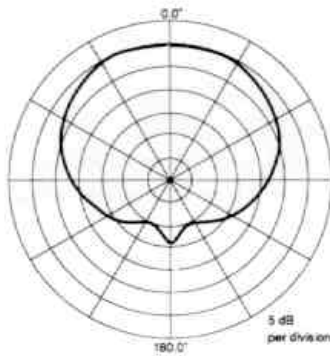

4 K

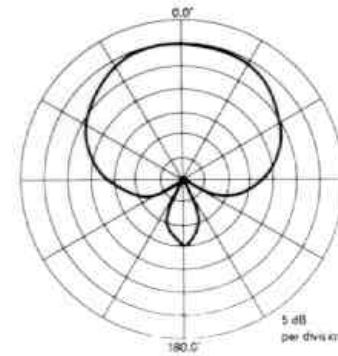

6 K

The rumble filter is designed using a specialized high quality transformer allowing it to work without degradation to the low frequency signals and maintaining true balanced low impedance operation. Handling noise is virtually a thing of the past.

Next, a tougher finish and new feel is accomplished using the latest in material and coating technology. The finish is designed to keep the microphone looking as well as it performs through the years.

A neodymium iron boron magnet is the heart of the high output unit. The rare earth magnet allows for output expected only from condenser type microphones – but without the use of batteries or external power supplies. The PVM™ 535i has been designed with the vocal performer in mind. The

diaphragm material is super light yet rigid improving transient response and vocal clarity.

Vocalists will enjoy the smooth clean low end produced. The frequency response is tailored for "hand held" applications, producing flat low end with a slight rise in the upper vocal range where sibilance is important for clarity.

The internal pop filter has been redesigned to give excellent protection against plosive sounds "th" and "p." An external windscreen is supplied for cases where extreme wind conditions exist.

The unit comes in a durable hard shell case and is supplied with a premium quality 25' low impedance XLR type cable.

ARCHITECTURAL & ENGINEERING SPECIFICATIONS

The microphone shall be a moving coil dynamic with a frequency response of 40 Hz to 16 kHz. The microphone shall have a cardioid polar characteristic typically 20 dB down from the front response. The microphone shall have an output power level of -52 dB where 0 dB = 1 milliwatt per pascal and nominal impedance of 400 ohms. The connector shall be a three-pin XLR equivalent audio type, and a swivel adaptor shall be provided to mount on a stand having 5/8" 27 thread. The microphone shall have overall dimensions of 5 3/4" in length and 1 7/8" in diameter. The microphone shall be a Peavey model PVM™ 535i Neo-Dynamic™ or equivalent.

PEAVEY MICROPHONE LIMITED WARRANTY/REMEDY

PEAVEY ELECTRONICS CORPORATION ("Peavey") warrants this microphone to the original retail purchaser to be free from defects in material and workmanship for a period of one (1) year from date of purchase; provided, however, that the existence of this limited warranty is subject to the conditions, exclusions and limitations hereinafter set forth.

In case of a covered defect in material or workmanship, Peavey will repair or replace the microphone, at Peavey's option, provided that consumer:

(a) brings the defective microphone to any Peavey Authorized Dealer or Service Center and presents therewith a copy of the sales receipt or other proof of purchase. If the DEALER or SERVICE CENTER is unable to provide the necessary warranty service, the consumer will be directed to the nearest other PEAVEY AUTHORIZED DEALER or SERVICE CENTER which can provide such service; or

(b) returns the defective microphone, shipping charges prepaid, to Peavey Electronics Corporation, 326 Hwy. 11 & 80 East, Meridian, Mississippi, and includes therewith a written description of the problem, a copy of the sales receipt or other proof of purchase and consumer's complete return address.

If the defect is remedial under this limited warranty and the other terms and conditions expressed herein have been complied with, Peavey will provide the necessary warranty service to repair or replace the microphone and will return it, freight collect, to the consumer.

Under no circumstances will Peavey be liable for any lost profits, lost savings or other consequential or incidental damages arising out of the use or inability to use the product, even if Peavey had been advised of the possibility of such damage.

THIS LIMITED WARRANTY IS IN LIEU OF ANY AND ALL WARRANTIES, EXPRESSED OR IMPLIED, INCLUDING, BUT NOT LIMITED TO, THE IMPLIED WARRANTIES OF MERCHANTABILITY AND FITNESS FOR PARTICULAR USE; provided, however, that upon compliance with the other terms and conditions necessary to the existence of the express limited warranty, such implied warranties are not disclaimed during the applicable one year period from date of purchase of this product.

SOME STATES DO NOT ALLOW LIMITATIONS ON HOW LONG AN IMPLIED WARRANTY LASTS OR THE EXCLUSION OR LIMITATION OF INCIDENTAL OR CONSEQUENTIAL DAMAGES, SO THE ABOVE LIMITATIONS OR EXCLUSIONS MAY NOT APPLY TO YOU, THIS LIMITED WARRANTY GIVES YOU SPECIFIC LEGAL RIGHTS, AND YOU MAY ALSO HAVE OTHER RIGHTS WHICH MAY VARY FROM STATE TO STATE.

In the event any modification or disclaimer of express or implied warranties or any limitation of remedies contained herein conflicts with applicable law, then such modification, disclaimer or limitation as the case may be, shall be deemed to be modified to the extent necessary to comply with such law.

Peavey Electronics Corporation gives this limited warranty only with respect to Peavey microphones purchased in the United States of America. This limited warranty shall be void and of no effect if:

- (a) first purchase of the product is for the purpose of resale; or
- (b) the original retail purchase is not made from an AUTHORIZED PEAVEY DEALER; or
- (c) the product has been damaged by accident or unreasonable use, neglect, improper service or maintenance, or other causes not arising out of defects in material or workmanship.

Built under patent numbers: U.S. - 5,033,093; Canada - 2,011,690; R.O.C. - 62664; Korea - 71938; Europe - 0446515 (U.K., Germany, Austria). Patent pending.

PEAVEY®

Features and specifications subject to change without notice.

Peavey Electronics Corporation 711 A Street / Meridian, MS 39301 / U.S.A. / (601) 483-5365 / Telex 504115 / Fax 486-1278
©1994 #80301922 Printed in U.S.A. 12/94

Free Manuals Download Website

<http://myh66.com>

<http://usermanuals.us>

<http://www.somanuals.com>

<http://www.4manuals.cc>

<http://www.manual-lib.com>

<http://www.404manual.com>

<http://www.luxmanual.com>

<http://aubethermostatmanual.com>

Golf course search by state

<http://golfingnear.com>

Email search by domain

<http://emailbydomain.com>

Auto manuals search

<http://auto.somanuals.com>

TV manuals search

<http://tv.somanuals.com>