



PVM™ 580TN

Unidirectional
Hypercardioid
Dynamic Microphone

SPECIFICATIONS:

Enclosure:

PVM™ 580TN

Element Type:

Dynamic

Magnet Composition:

Neodymium Iron Boron

Polar Pattern:

Hypercardioid

Front to Back Rejection:

20 dB typical

Impedance:

Low (300 ohms, balanced)

Sensitivity:

Output Power Level:

-52 dB (0 dB = 1mW/10 microbar*)

Open Circuit Voltage:

-68 dB (0 dB = 1 volt/dyne/cm²)

Case (Housing):

Die-cast alloy

Finish:

Low gloss black - Teflon® based

Windscreen:

Brazed steel mesh

Pop Filter:

Dual Integral, Open Cell Foam

Connector:

3-pin XLR type

Phasing:

Positive (inward) pressure on diaphragm produces positive voltage at pin #2

Weight:

14 oz. (400 grams)

Furnished Accessories:

Carrying case, swivel adaptor, foam windscreen, 25' (7.62 m) balanced low impedance cable with 3-pin and 3-socket XLR equivalent audio connectors

FEATURES

- Neodynamic design
- Hypercardioid polar response
- Titanium laminate diaphragm
- Neodymium magnetics
- Superior off axis rejection
- Superb feedback rejection
- Warm vocal response
- Mechanically controlled handling characteristics
- Ultra-high sensitivity

DESCRIPTION

The PVM™ 580TN is a unidirectional, hypercardioid, dynamic microphone which relies on the latest in rare earth magnet technology to achieve maximum output sensitivity. Its hypercardioid response pattern insures freedom from feedback and ease of setup. The Neodymium Iron Boron magnet provides much higher magnetic flux than traditional dynamic microphone designs, resulting in an output level usually expected only from condenser microphones -- but without the need for batteries or external power supplies.

The titanium laminate diaphragm provides full range response and also superb transient performance. This combination of advanced technology and real world optimization makes the PVM 580TN one of the most versatile and indispensable tools for the trade.

The PVM 580TN exemplifies the term "vocal microphone." Designed for hand-held operation, this microphone delivers a warm vocal response that can cut through in high level stage environments.

*10 microbars = 1 pascal = 10 dynes/cm²

The comfortable mildly-textured handle assembly includes the latest in shock-mounting technology to greatly minimize shock generated noises, such as handling sounds and mic stand rumble.

The PVM 580TN also utilizes an integral, dual section, acoustic foam filter to minimize wind noise and plosive vocal effects.

An external foam windscreen is also supplied to provide an extra level of wind noise protection in extreme situations.

With the rugged roadworthiness of a top dynamic, and the high output level of a condenser, the PVM 580TN's ideal vocal response, coupled with its mechanically controlled handling characteristics, definitely put the product in the state-of-the-art category.

ARCHITECTURAL & ENGINEERING SPECIFICATIONS

The microphone shall be a moving coil dynamic type. The microphone shall have a hypercardioid polar characteristic with a rear response that is 15 to 20 dB down. The microphone shall have an output power level of -52 dBm where 0 dB = 1 milliwatt per 10 microbar and a nominal impedance of 300 ohms.

The microphone shall have non-reflecting, low gloss, black Teflon™ based paint on a die-cast alloy housing and a brazed metal screen. The connector shall be a 3-pin XLR equivalent audio type and a swivel adaptor shall be provided to mount on a stand having 5/8" 27 thread. The microphone shall have overall dimensions of 5 3/4" in length and 1 7/8" in diameter. The microphone shall be a Peavey Model PVM™ 580TN Neo-Dynamic™ or equivalent.

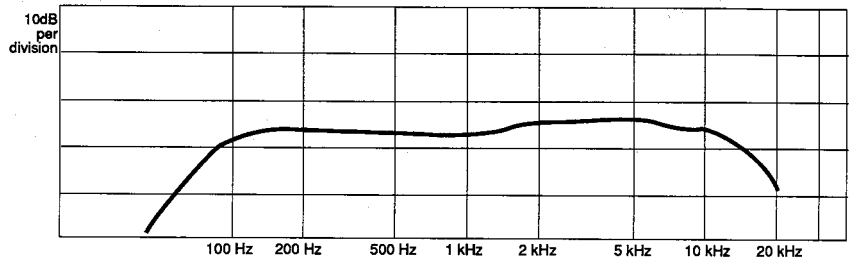

FREQUENCY RESPONSE

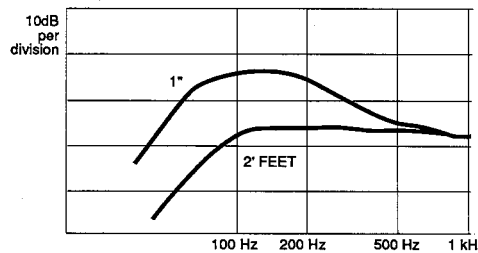

Proximity effect is a naturally occurring phenomenon in unidirectional microphones. The effect is to accentuate or boost the low frequency response. This effect is a function of distance from the diaphragm to the source and increases as the diaphragm is moved closer to the source.

FREQUENCY RESPONSE PROXIMITY EFFECT

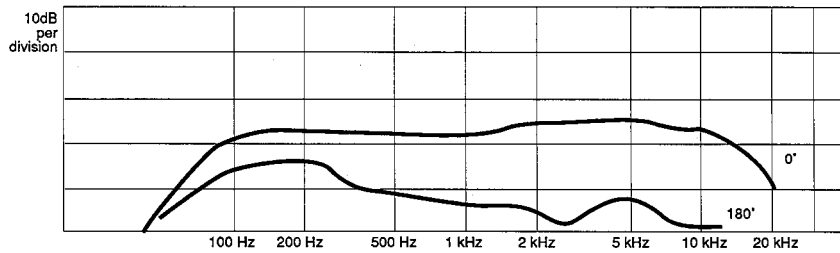

0° & 180° FREQUENCY RESPONSE

POLAR PATTERNS

10dB
per
division

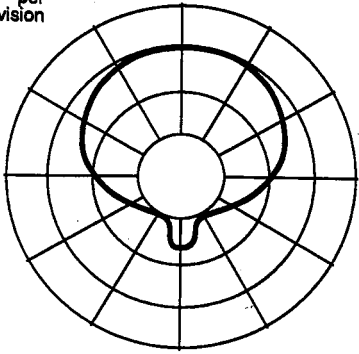

500Hz

10dB
per
division

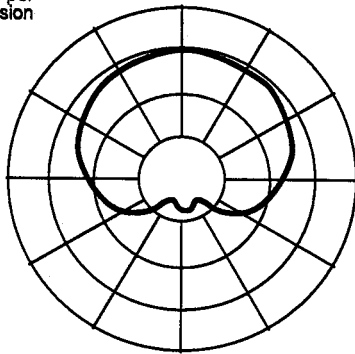

1K

10dB
per
division

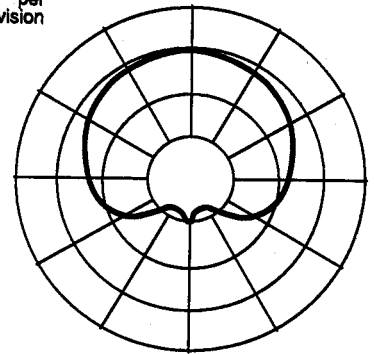

2K

10dB
per
division

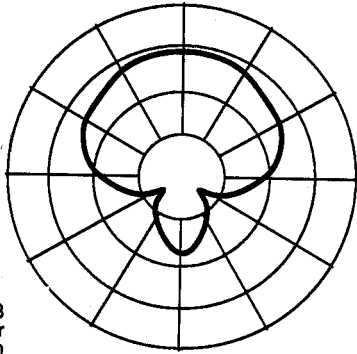

5K

10dB
per
division

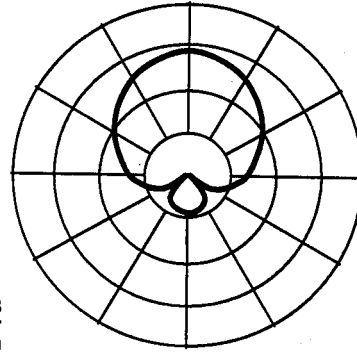

10K

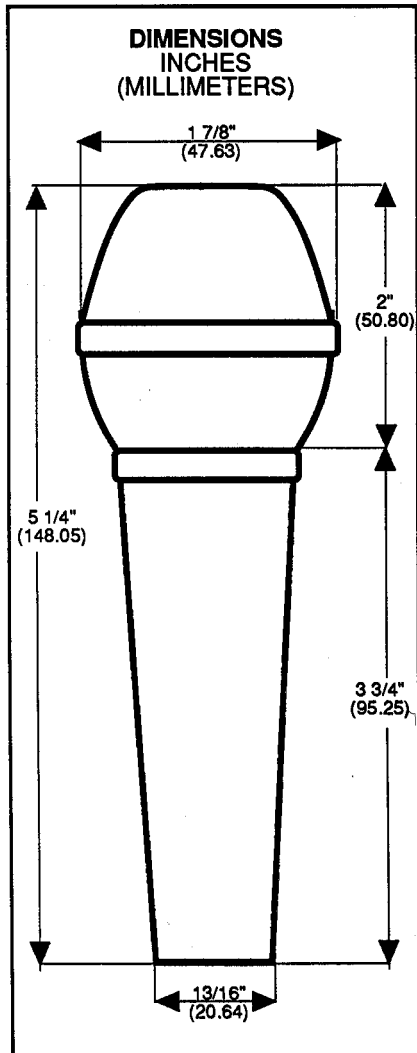

ACCESSORIES

Durable flite-type carrying case, swivel adaptor, foam windscreen, and 25' (7.62m) balanced low impedance cable with 3-pin XLR equivalent audio connectors.

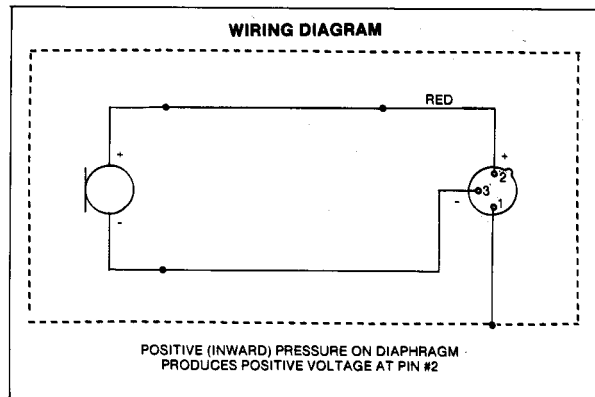

PEAVEY MICROPHONE LIMITED WARRANTY/REMEDY

PEAVEY ELECTRONICS CORPORATION ("Peavey") warrants this microphone to the original retail purchaser to be free from defects in material and workmanship for a period of one (1) year from date of purchase; provided, however, that the existence of this limited warranty is subject to the conditions, exclusions and limitations hereinafter set forth.

In case of a covered defect in material or workmanship, Peavey will repair or replace the microphone, at Peavey's option, provided that consumer:

- (a) brings the defective microphone to any Peavey Authorized Dealer or Service Center and presents therewith a copy of the sales receipt or other proof of purchase. If the DEALER or SERVICE CENTER is unable to provide the necessary warranty service, the consumer will be directed to the nearest other PEAVEY AUTHORIZED DEALER or SERVICE CENTER which can provide such service; or
- (b) return the defective microphone, shipping charges prepaid, to Peavey Electronics Corporation, International Service Center, Hwy. 80 East, Meridian, Mississippi 39301, and includes therewith a written description of the problem, a copy of the sales receipt or other proof of purchase and a complete return address.

If the defect is remedial under this limited warranty and the other terms and conditions expressed herein have been complied with, Peavey will provide the necessary warranty service to repair or replace the microphone and will return it, freight collect.

Under no circumstances will Peavey be liable for any lost profits, lost savings or other consequential or incidental damages arising out of the use or inability to use the product, even if Peavey had been advised of the possibility of such damages.

THIS LIMITED WARRANTY IS IN LIEU OF ANY AND ALL WARRANTIES, EXPRESSED OR IMPLIED, INCLUDING, BUT NOT LIMITED TO, THE IMPLIED WARRANTIES OF MERCHANTABILITY AND FITNESS FOR PARTICULAR USE; provided, however, that upon compliance with the other terms and conditions necessary to the existence of the express limited warranty, such implied warranties are not disclaimed during the applicable one year period from date of purchase of this product.

SOME STATES DO NOT ALLOW LIMITATIONS ON HOW LONG AN IMPLIED WARRANTY LASTS OR THE EXCLUSION OR LIMITATION OF INCIDENTAL OR CONSEQUENTIAL DAMAGES, SO THE ABOVE LIMITATIONS OR EXCLUSIONS MAY NOT APPLY TO YOU. THIS LIMITED WARRANTY GIVES YOU SPECIFIC LEGAL RIGHTS, AND YOU MAY ALSO HAVE OTHER RIGHTS WHICH MAY VARY FROM STATE TO STATE.

In the event any modification or disclaimer of express or implied warranties or any limitation of remedies contained herein conflicts with applicable law, then such modification, disclaimer or limitation as the case may be, shall be deemed to be modified to the extent necessary to comply with such law.

Peavey Electronics Corporation gives this limited warranty only with respect to Peavey microphones purchased in the United States of America. This limited warranty shall be void and of no effect if:

- (a) first purchase of the product is for the purpose of resale; or
- (b) the original retail purchase is not made from an AUTHORIZED PEAVEY DEALER; or
- (c) the product has been damaged by accident or unreasonable use, neglect, improper service or maintenance, or other causes not arising out of defects in material or workmanship.

Should you have any questions or problems, please contact your nearest authorized dealer or the factory.



Features and specifications subject to change without notice.

PEAVEY ELECTRONICS CORPORATION / 711 A Street / Meridian, MS 39302-2898 / U.S.A. / Telephone: (601) 483-5365 / Telex: 504115 / Fax: 484-4278

Free Manuals Download Website

<http://myh66.com>

<http://usermanuals.us>

<http://www.somanuals.com>

<http://www.4manuals.cc>

<http://www.manual-lib.com>

<http://www.404manual.com>

<http://www.luxmanual.com>

<http://aubethermostatmanual.com>

Golf course search by state

<http://golfingnear.com>

Email search by domain

<http://emailbydomain.com>

Auto manuals search

<http://auto.somanuals.com>

TV manuals search

<http://tv.somanuals.com>