

# XR<sup>®</sup> 1600F

20-Channel—3x200 WATTS TRI-POWERED CONSOLE

Operating Guide

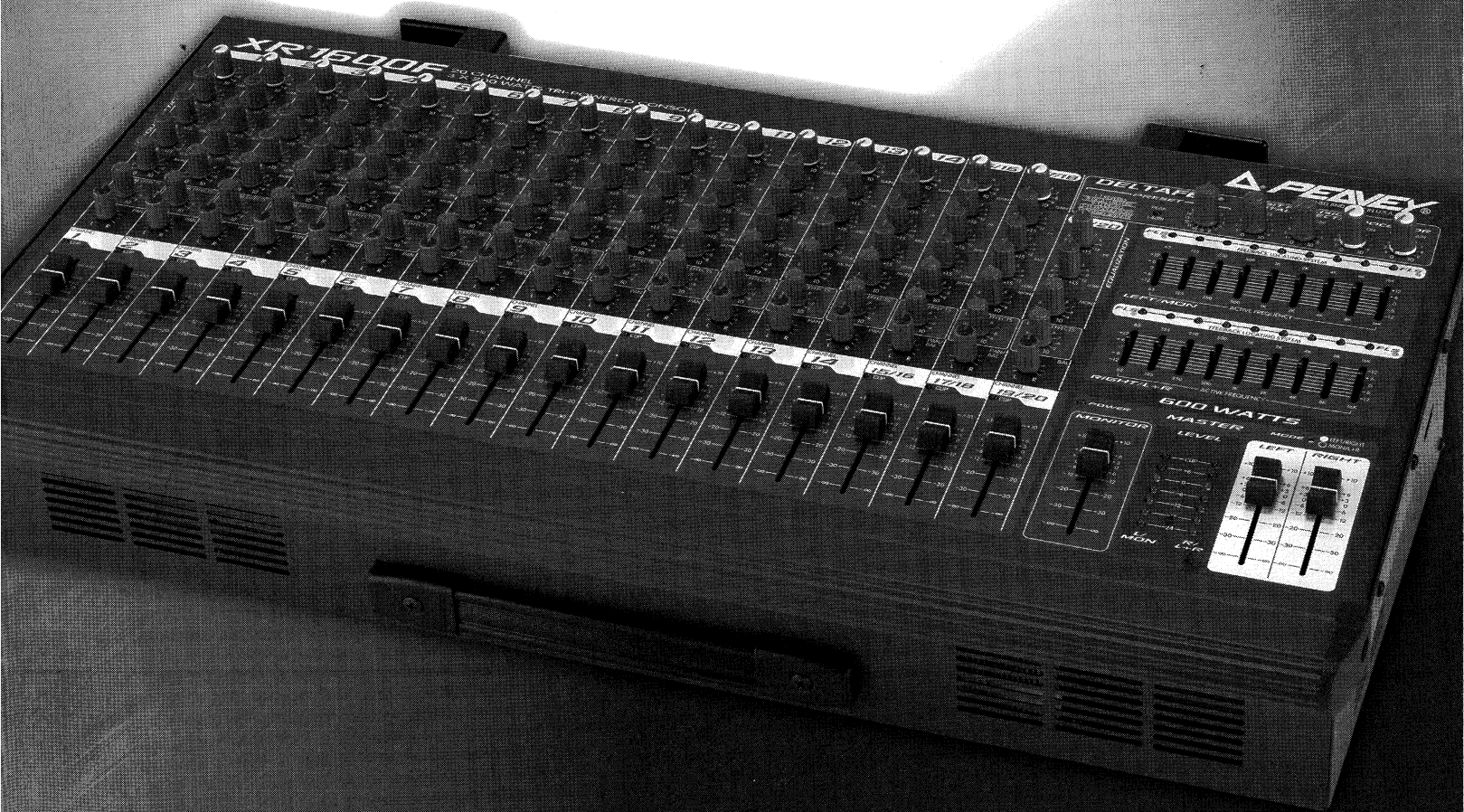



Intended to alert the user to the presence of uninsulated “dangerous voltage” within the product’s enclosure that may be of sufficient magnitude to constitute a risk of electric shock to persons.



Intended to alert the user of the presence of important operating and maintenance (servicing) instructions in the literature accompanying the product.

**CAUTION:** Risk of electrical shock — DO NOT OPEN!

**CAUTION:** To reduce the risk of electric shock, do not remove cover. No user serviceable parts inside. Refer servicing to qualified service personnel.

---

**WARNING:** To prevent electrical shock or fire hazard, do not expose this appliance to rain or moisture. Before using this appliance, read the operating guide for further warnings.



Este símbolo tiene el propósito, de alertar al usuario de la presencia de “(voltaje) peligroso” sin aislamiento dentro de la caja del producto y que puede tener una magnitud suficiente como para constituir riesgo de descarga eléctrica.



Este símbolo tiene el propósito de alertar al usuario de la presencia de instrucciones importantes sobre la operación y mantenimiento en la información que viene con el producto.

**PRECAUCION:** Riesgo de descarga eléctrica ¡NO ABRIR!

**PRECAUCION:** Para disminuir el riesgo de descarga eléctrica, no abra la cubierta. No hay piezas útiles dentro. Deje todo mantenimiento en manos del personal técnico cualificado.

---

**ADVERTENCIA:** Para evitar descargas eléctricas o peligro de incendio, no deje expuesto a la lluvia o humedad este aparato. Antes de usar este aparato, lea más advertencias en la guía de operación.



Ce symbole est utilisé dans ce manuel pour indiquer à l'utilisateur la présence d'une tension dangereuse pouvant être d'amplitude suffisante pour constituer un risque de choc électrique.



Ce symbole est utilisé dans ce manuel pour indiquer à l'utilisateur qu'il ou qu'elle trouvera d'importantes instructions concernant l'utilisation et l'entretien de l'appareil dans le paragraphe signalé.

**ATTENTION:** Risques de choc électrique — NE PAS OUVRIR!

**ATTENTION:** Afin de réduire le risque de choc électrique, ne pas enlever le couvercle. Il ne se trouve à l'intérieur aucune pièce pouvant être réparée par l'utilisateur. Confiez l'entretien et la réparation de l'appareil à un réparateur Peavey agréé.

---

**AVERTISSEMENT:** Afin de prévenir les risques de décharge électrique ou de feu, n'exposez pas cet appareil à la pluie ou à l'humidité. Avant d'utiliser cet appareil, lisez attentivement les avertissements supplémentaires de ce manuel.



Dieses Symbol soll den Anwender vor unisolierten gefährlichen Spannungen innerhalb des Gehäuses warnen, die von Ausreichender Stärke sind, um einen elektrischen Schlag verursachen zu können.



Dieses Symbol soll den Benutzer auf wichtige Instruktionen in der Bedienungsanleitung aufmerksam machen, die Handhabung und Wartung des Produkts betreffen.

**VORSICHT:** Risiko — Elektrischer Schlag! Nicht öffnen!

**VORSICHT:** Um das Risiko eines elektrischen Schlages zu vermeiden, nicht die Abdeckung entfernen. Es befinden sich keine Teile darin, die vom Anwender repariert werden könnten. Reparaturen nur von qualifiziertem Fachpersonal durchführen lassen.

---

**ACHTUNG:** Um einen elektrischen Schlag oder Feuergefahr zu vermeiden, sollte dieses Gerät nicht dem Regen oder Feuchtigkeit ausgesetzt werden. Vor Inbetriebnahme unbedingt die Bedienungsanleitung lesen.

# ENGLISH

## XR® 1600F

### Powered Sound Reinforcement Mixing Console

Congratulations on your purchase of the XR 1600F powered mixer, the largest member of the famous Peavey XR family. We have packed features from the popular XR 684 and XR 800F into a professional 20-channel, tabletop package. Replacing the XR 1204, the XR 1600F combines three distinct power amps (two stereo L & R/one monitor) with the latest in technology and packaging. Here are several features you will find on the XR 1600F.

- 20 channels
- 16 low noise, low-Z mic preamps
- 14 Hi-Z line inputs
- RCA Tape In/Out (Channel 19/20)
- Channel and master L/R faders
- Individual monitor master fader
- Channel clipping LEDs
- Channel stereo pan controls
- Three-band equalization (Channels 1-18)
- Monitor send (each channel)
- EFX send (each channel)
- Three Stereo line inputs (Channels 15/16, 17/18 and 19/20)
- Advanced 32-bit, DSP-based stereo reverb/effects with two parameter controls
- Two nine-band graphic EQs with FLS® Feedback Locating System®
- Selectable 48V phantom power
- Dual seven-segment master level meters
- Three power amps - 3x200W @ 4 ohms internal power amplifiers
- DDT™ speaker protection

The standard channels (1-14) feature discrete low noise mic preamps with globally switched phantom power, line level 1/4" inputs, and three-band EQs. There are three stereo channels (15/16, 17/18 and 19/20) for tape, CD, or synth inputs. Channels 15/16 and 17/18 reflect channels 1 through 14 with added stereo 1/4" input jacks. Channel 19/20, however, has a two-band EQ, no input gain control, and stereo tape input and output (pre master fader) RCA jacks. Monitor sends are included on all channels as well as effects sends.

The master section features two (mains L&R) graphic equalizers with FLS. Without patching, the XR 1600F can be used as a full stereo mixer amplifier with stereo EQ. This eliminates external equipment and noisy patch cables. A stereo, master seven-segment LED level meter is provided to indicate operating levels. In addition, a monitor fader is included for easy monitor level adjustment.

Also included in the master section are 16 stereo digital effects from the award winning Deltafex® digital signal processor. By including separate time/size and color/tone controls, the user can create many effect settings from the 16 provided by factory. All channels have a dedicated digital effects send routed directly to the DSP effects processor.

To take advantage of the XR 1600F's powerful features, please read this owner's manual carefully and keep it as a reference. This guide includes several sections detailing individual areas of mixer operation, including: control functions, setup, and applications in sound reinforcement. Before the channel and master functions are explained, we will begin with connecting AC power and speakers to the XR 1600F.

## AC POWER SECTION (Rear Panel):

The AC POWER SECTION explains the proper connections/method to supply AC power to your XR 1600F. Please pay close attention to the precaution(s) noted below in order to ensure both personal and equipment safety.

### 1. REMOVABLE AC POWER CORD

 This receptacle is for the IEC line cord (included), which provides AC power to the unit. Connect the line cord to this connector and to a properly grounded AC supply. Damage to the equipment may occur if an improper line voltage is used. (See voltage marking on unit.) Never remove or cut the ground pin of the line cord plug. This unit is supplied with a properly rated line cord. When lost or damaged, replace this cord with one of the proper ratings.

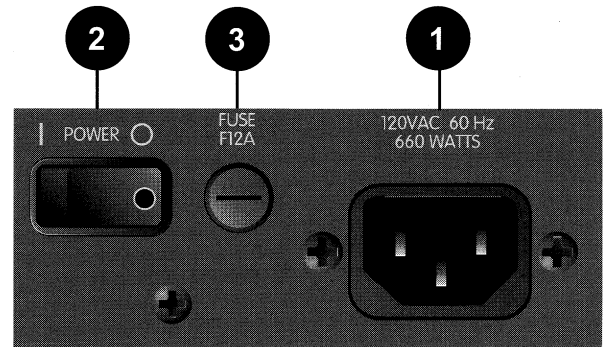

### NOTE: FOR UK ONLY

As the colors of the wires in the mains lead of this apparatus may not correspond with the colored markings identifying the terminals in your plug, proceed as follows: (1) The wire which is colored green and yellow must be connected to the terminal which is marked by the letter E, or by the earth symbol, or colored green or green and yellow. (2) The wire which is colored blue must be connected to the terminal which is marked with the letter N, or the color black. (3) The wire which is colored brown must be connected to the terminal which is marked with the letter L or color red.

### 2. POWER

The mixer's main power switch. The POWER LED indicator (22) will illuminate when the unit is powered.

### 3. FUSE

This is the main safety fuse for the AC line voltage. Only replace the fuse with one of the exact same type and rating. IF THE FUSE CONTINUES TO BLOW, DO NOT REPLACE WITH A LARGER FUSE. TAKE THE UNIT TO AN AUTHORIZED PEAVEY SERVICE CENTER!

 **WARNING:** THE FUSE SHOULD ONLY BE REPLACED WHEN THE POWER CORD HAS BEEN DISCONNECTED FROM ITS POWER SOURCE.

## POWER AMPLIFIER SECTION (Rear Panel):

Your XR 1600F contains three individual 200-watt power amplifiers with various patching connections. The POWER AMPLIFIER SECTION will explain the proper method of connecting your XR 1600F to your speakers. This is a very versatile area of the XR 1600F. However, it is important that you follow the precautions to ensure safe operating impedances and avoid improper connections.

### 4. **STEREO LEFT/MON and RIGHT/L+R SPEAKER OUTPUTS**



These 1/4" jacks are the stereo

amplifier's speaker outputs. Both the LEFT/MON and RIGHT/L+R SPEAKER OUTPUTS provide two 1/4" jacks in parallel. By connecting a speaker cable(s) to this jack and to a speaker cabinet(s), you complete the signal chain. Several cabinets may be connected to each channel, as long as the combined impedance of the cabinets is not less than 4 ohms. (i.e., two 8 ohms cabinets in parallel = 4 ohms, four 16 ohms speakers in parallel = 4 ohms, etc.).

**NOTE: Refer to the System Mode Switch (21) to determine which signal is sent to these EQ/power amps.**

### 5. **SUB/MON/AUX SPEAKER OUTPUT**

These two parallel 1/4" jacks provide the output of the third power amplifier. By connecting a speaker cable(s) to this output and to a speaker cabinet(s), you complete the signal chain. Several cabinets may be connected to these output jacks, as long as the combined impedance of the cabinets is not less than 4 ohms. (i.e., two 8 ohms cabinets in parallel = 4 ohms, four 16 ohms speakers in parallel = 4 ohms, etc.). The output signal of the SUB/MON/AUX SPEAKER OUTPUT is determined by the AUX POWER AMP INPUT SELECT SWITCH (9) and the SYSTEM MODE SWITCH (21).

**NOTE: Refer to the AUX Power Amp Input Select Switch (9) to determine which signal is sent to this power amp.**

Finally, you may patch a signal directly into the SUB/MON/AUX Power Amp through the Aux Power Amp Input (8). This will disconnect any previous signal routing for this amp.

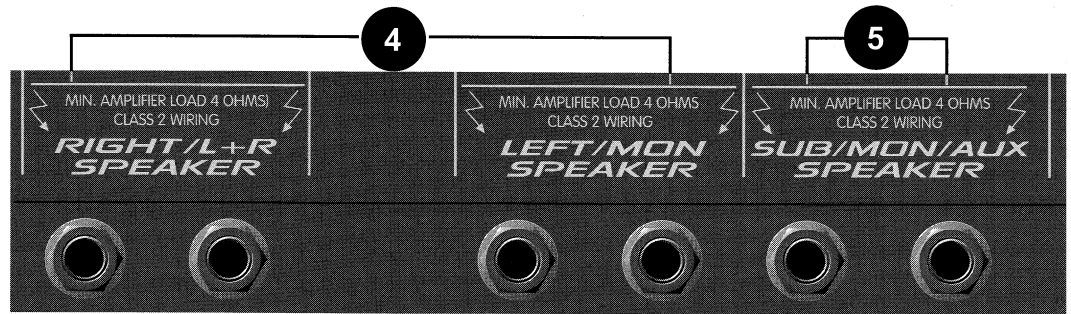

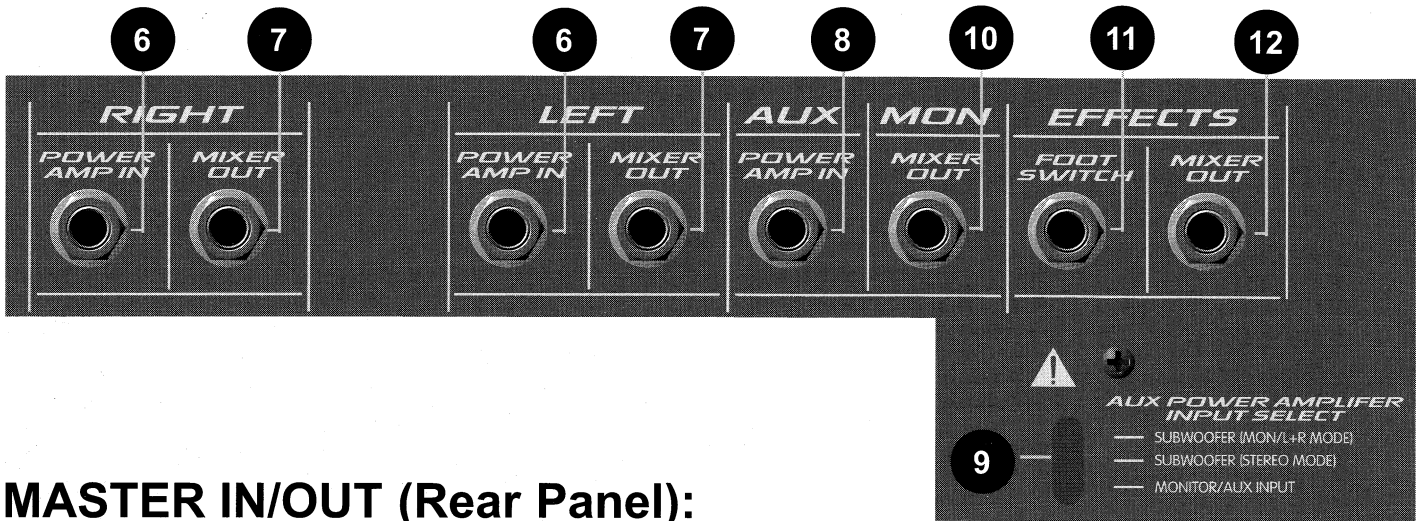

## MASTER IN/OUT (Rear Panel):

The MASTER IN/OUT section describes the functions related to the input and output patch panel located on the rear of your XR 1600F. This section is often overlooked but adds the most versatility to the XR 1600F. When used to its fullest potential, an extraordinary variety of wiring configurations can be made. These connections allow for devices such as outboard effects, additional power amps, monitors, and virtually any other type of line level audio device to be patched to the XR 1600F. Some of these configurations are displayed in the hook up diagram found at the end of this manual.

### 6. LEFT/RIGHT POWER AMP INPUTS

Plugging into these jacks allows the user to go directly into the stereo graphic equalizers (L&R), then into its respective power amplifier channel. The jacks for these inputs are switching jacks. This means that if you plug into the jack you will defeat any prior signal from the channel, master and effects sections of the mixer. A benefit of this feature is that you can then use the internal stereo EQ and power amp as a slave stereo EQ/power amp when needed. These inputs can also be used as the return portion of an effects loop, utilizing the LEFT/RIGHT MIXER OUTPUTS (7) as the sends.

### 7. LEFT/RIGHT MIXER OUTPUTS

These 1/4" jacks provide an output from the Left and Right stereo preamp output to supply external amp/speaker combinations. The level of this signal is determined by the Stereo Left/Right Faders (25). These outputs can also be used as the send portion of an effects loop, utilizing the LEFT/MON and RIGHT/L+R POWER AMP INPUTS (6) as the returns.

### 8. AUX POWER AMP INPUT

Plugging into this jack allows you to insert a line level signal directly into the SUB/MON/AUX POWER AMPLIFIER. The AUX POWER AMP INPUT SELECT SWITCH (9) must be in the Monitor/Aux position for this input to have any effect. If nothing is inserted in this input jack and the AUX POWER AMP INPUT SELECT SWITCH (9) is left in the Monitor/Aux position, the output at the amp will be the monitor signal. A benefit of this feature is that you can use the third internal power amp as a spare when an extra monitor or side fill is needed. This input can also be used as the return portion of an monitor effects loop, utilizing the MONITOR MIXER OUTPUT (10) as the sends.

**NOTE: Refer to the AUX Power Amp Input Select Switch (9) for more information.**

## 9. AUX POWER AMP INPUT SELECT SWITCH

This switch, along with the System Mode Switch (21), determines where the third, SUB/MON/AUX, power amp receives its input. This ultimately determines the output found at the SUB/MON/AUX SPEAKER OUTPUT (5). Let's look at each switch position individually.

**Note:** Keep in mind that this switch position works in conjunction with the System Mode Switch (21) to determine the final output. Set the System Mode Switch to the mode you wish the XR1600F to operate in first. Then select the AUX POWER AMP INPUT SELECT SWITCH position to determine the output of the SUB/MON/AUX POWER AMP. In both Subwoofer positions it is important to note the item in parentheses next to the Subwoofer switch. Match the note in parenthesis to the current position of the System Mode Switch (21). Place this INPUT SELECT SWITCH in that "matched" position for proper operation. [Ex. If the you have placed the SYSTEM MODE SWITCH in the Left/Right position and you desire to use the SUB/MON/AUX POWER AMP to power a subwoofer, then you should place the INPUT SELECT SWITCH in the SUBWOOFER (Stereo Mode) position.] This is done to maintain internal switching/patching thus reducing the need for external patch cables.

**Subwoofer (Mon/L+R Mode):** A sum of the stereo L+R signals is provided when the AUX POWER AMP INPUT SELECT SWITCH is in this position and the System Mode Switch (21) is in the MON/L+R position. If the System Mode Switch is in the Left/Right position (not recommended), the output will be a combination of the L+R sum with the Monitor signal added in.

This signal is a low frequency subwoofer signal (<125 Hz) intended to supply an external subwoofer. The level for the output in this mode is controlled by the LEFT/RIGHT FADERS (25). Refer to the Recommended Hookup Diagram on pg. 16.

**Subwoofer (Stereo Mode):** A sum of the stereo L+R signal is provided when the AUX POWER AMP INPUT SELECT SWITCH is in this position and the System Mode Switch (21) is in the LEFT/RIGHT position. If the System Mode Switch is in the MON/L+R position (not recommended), the output will contain only Right channel material.

This signal is a low frequency subwoofer signal (<125 Hz) intended to supply an external subwoofer. The level for the output in this mode is controlled by the LEFT/RIGHT FADERS (25). Refer to the Recommended Hookup Diagram on pg. 16.

**Monitor/AUX Input:** This position allows one of two signals to enter the power amp. Without inserting a signal into the AUX POWER AMP INPUT (8), the monitor mix is sent to the SUB/MON/AUX POWER AMP. The level for the output in this monitor mode is controlled by the MASTER MONITOR FADER (23). You may insert a line level signal into the AUX POWER AMP INPUT (8) while the AUX POWER AMP INPUT SELECT SWITCH is in this position. Doing this disconnects the monitor signal allowing the amp to receive the external input. The level for this AUX mode is controlled by the source of the signal. Refer to the Recommended Hookup Diagram on pg. 17.

**NOTE:** Each mode mentioned above affects **only** the SUB/MON/AUX POWER AMP INPUT/OUTPUT. The SYSTEM MODE SWITCH (21) is only a factor when the subwoofer positions are utilized.

## 10. MONITOR MIXER OUTPUT

This 1/4" jack provides a line level output from the monitor mix to supply external power amp/monitor combinations. The level of this signal is determined by the MONITOR FADER (23). This output can also be used as the send portion of an effects loop, utilizing the MONITOR POWER AMP INPUT (8) as the return.

## 11. EFFECTS FOOTSWITCH

This 1/4" (Tip/Sleeve) jack provides a means to defeat the internal effects of the XR 1600F. A standard on/off footswitch, such as the Peavey part number 5100, is recommended.

## 12. EFFECTS MIXER OUTPUT

This 1/4" stereo jack provides the left and right effects outputs. This stereo output can be patched to the input of an additional external effects unit and patched back into one of the stereo line inputs on input channels 15/16 or 17/18. See #38 and #39.

## MASTER FUNCTIONS (Front Panel):

The MASTER FUNCTIONS section describes those features that are considered master controls. Essentially, this makes up all of the functions on the right-hand, front panel side of your XR 1600F. The areas of detail include; Effects, EQ/FLS and Monitor/Main Level Controls.

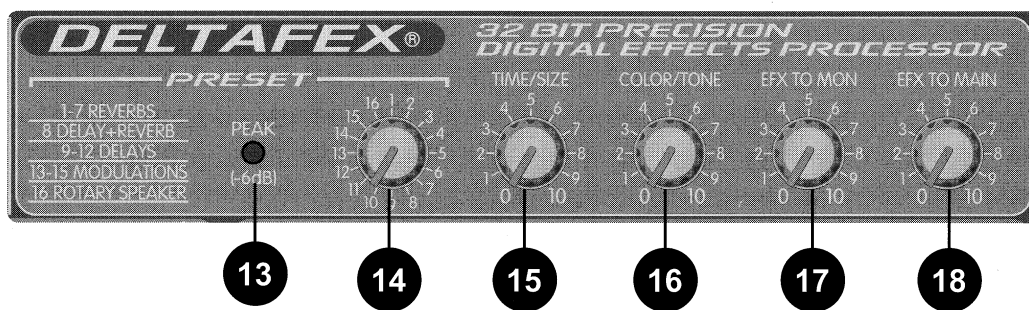

## 13. EFFECTS PEAK LED

Illuminates to indicate -6 dB of headroom before the signals being sent to the effects circuit are clipped. Ideally, you would want this LED to light only occasionally if at all. An occasional blink indicates that you have the levels at an optimum setting. It is advisable to listen carefully to the output at the same time in order to determine the final setting.

## 14. PRESET

Selects the effect preset from the list below.

### EFX Presets

PRESET	NAME	TIME/SIZE	COLOR/TONE
1	Chamber	Time: 150 to 5,000 ms	Damping (High Frequency)
2	Plate	Time: 100 to 4,000 ms	Damping (High Frequency)
3	Room	Time: 150 to 5,000 ms	Damping (High Frequency)
4	Cathedral	Time: 100 to 8,000 ms	Damping (High Frequency)
5	Spring	Time: 150 to 5,000 ms	Damping (High Frequency)
6	Gate	Time: 150 to 500 ms	Damping (High Frequency)

continued on next page



PRESET	NAME	TIME/SIZE	COLOR/TONE
7	Reverse	Time: 150 to 500 ms	Damping (High Frequency)
8	Delay + Reverb	Time: 0 to 225 ms	Reverb Time: 0 to 5,000 ms
9	Bright Delay	Time: 0 to 500 ms	Feedback: 0 to 99%
10	Warm Delay	Time: 0 to 500 ms	Feedback: 0 to 99%
11	Dark Delay	Time: 0 to 500 ms	Feedback: 0 to 99%
12	Ping Pong Delay	Time: 0 to 500 ms	Feedback: 0 to 99%
13	Chorus	Rate: 0.125 to 8 Hz	Depth: Best Set Full CW
14	Phaser	Rate: 0.250 to 16 Hz	Depth: Best Set Full CW
15	Flange	Rate: 0.10 to 2.5 Hz	Depth: Best Set Full CW
16	Rotary Speaker	High Speed: 0.50 to 25 Hz	Width: 0 to 100% CW

## 15. TIME/SIZE

In Reverb and Delay presets, this control adjusts the time of the particular reverb or delay; in Chorus, Phaser, and Flange, it adjusts the rate of each. In Rotary Speaker setting, this adjusts the speed of the speaker rotation.

## 16. COLOR/TONE

Adjusts the high frequency content of the effects signal. (While using a delay this control adjusts the feedback or depth.)

## 17. EFX to MON

Controls the amount of effects signal sent to the monitor mix. This control allows effects to be heard from the stage via the monitor.

## 18. EFX to MAIN

Controls the amount of effects signal sent to the main mix.

## 19. FLS® (Feedback Locator System®)

These LEDs illuminate to indicate the frequency band of highest energy. When feedback occurs, this system will automatically indicate the graphics slider to use to decrease that frequency band's gain in order to lessen or eliminate feedback. (NOTE: These LEDs illuminate with any audio signal, not just during feedback.)

## 20. LEFT/MON & RIGHT/L+R GRAPHIC EQUALIZERS

These nine-band equalizers are fixed on one-octave centers. They are designed for 12 dB of cut and/or 12 dB of boost. Regardless of the SYSTEM MODE SWITCH (21) position, the EQ's are connected directly to their respective power amplifier inputs. External signals may be sent to the L/R Graphic EQs by inserting a signal at the L/R Power Amplifier Inputs (6).

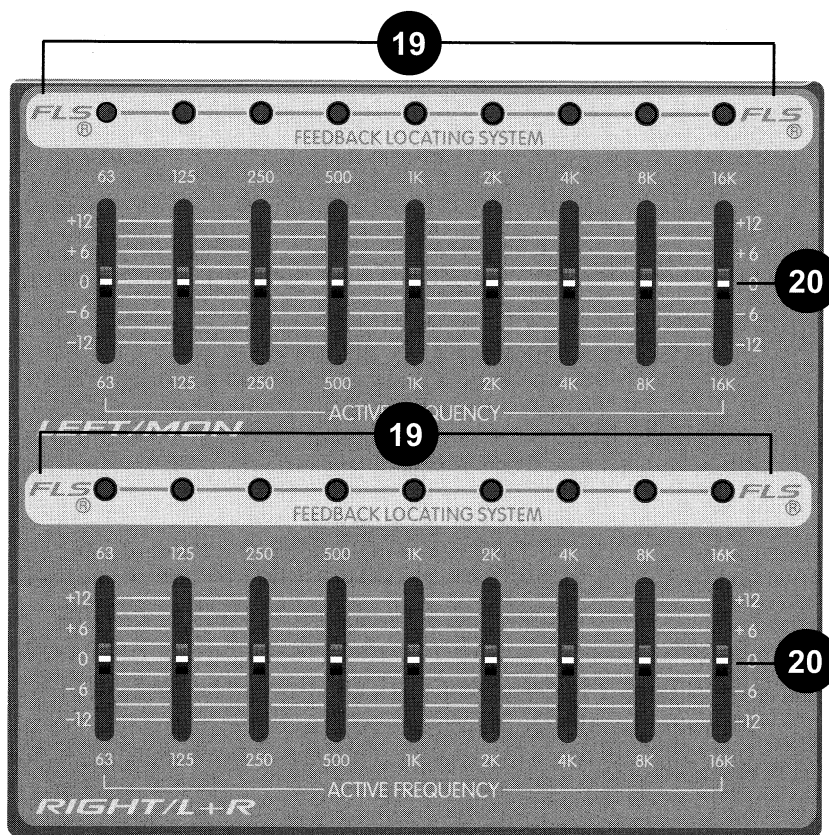

## 21. SYSTEM MODE SWITCH:

This switch is used to change the input sources to **only** the RIGHT/L+R and LEFT/MON POWER AMPS within your XR1600F. It is recessed to prevent accidental switching during a performance. Use a non-metallic object to change the switch position (e.g., a toothpick).

**CAUTION:** Before changing the position of this switch, turn the XR1600F off. Connect your mains speaker cable(s) according to the guide on pages 16 & 17. Refer to features 4 and 5 for minimum impedance specifications and cautions.

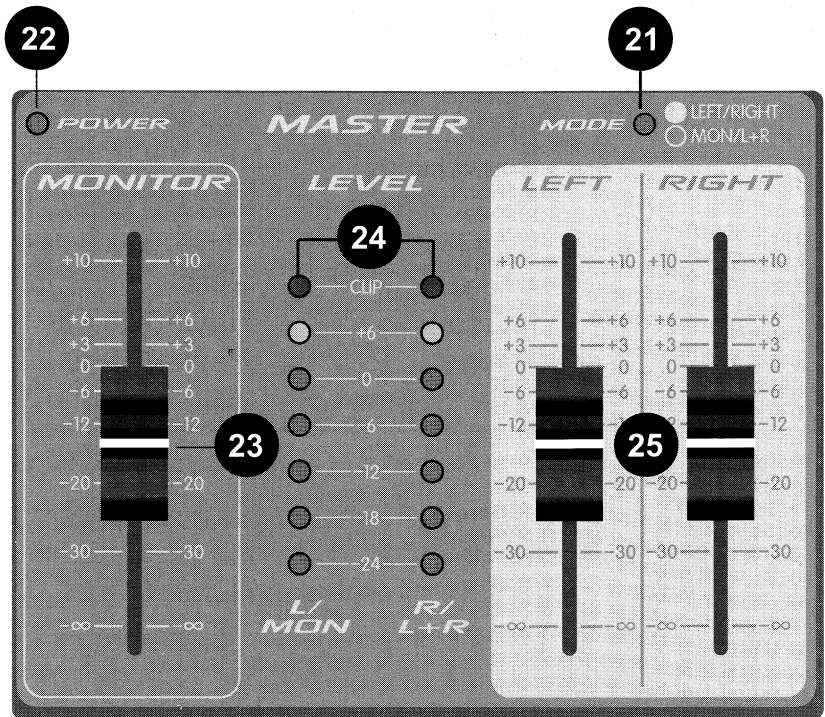

The XR 1600F is shipped from the factory with the Left Main signal going to the upper EQ/LEFT POWER AMP and the Right Main signal going to the lower EQ./RIGHT POWER AMP. When this switch is pressed in, it switches the lower EQ to carry the Left + Right signal. This is a mono signal (sum) representing a combination of the Left and Right signals. The upper EQ then carries the Monitor signal only, creating an entire PA and monitor mixing system with EQ for mains and monitor, in one small, easy-to-carry package. This change is accomplished without a single patch cord! The System Mode Switch **does not** affect the third amplifier (SUB/MON/AUX AMP) output.

## 22. POWER LED

The power on LED indicator will light when the unit is powered.

## 23. MASTER MONITOR FADER

Sets the overall level of the monitor signal that is sent to the MONITOR OUTPUT (10) jack. This fader is also the master level control for any power amp carrying the Monitor signal. The Monitor signal is often routed through the XR 1600F by various mode switches. Refer to the SYSTEM MODE SWITCH (21) and the AUX POWER AMP INPUT SELECT SWITCH (9) for details on Monitor signal routing.

## 24. SIGNAL LEVEL METERS

Displays overall level of the L&R signals. Red Clip LEDs are located at the top of each meter to indicate clipping. The L/R mains level is considered optimum when the red Clip LEDs flash only occasionally when your input signal(s) are at their maximum level.

## 25. MASTER L/R FADERS

This is the master level control for the L&R signals sent to the Left and Right Output jacks. The Right Fader controls the right stereo signal present at the RIGHT OUTPUT (7). The LEFT FADER controls the left stereo signal present at the LEFT OUTPUT (7). The nominal position for this control is the 0 dB position.

## CHANNEL FUNCTIONS:

The CHANNEL FUNCTIONS section describes the controls and input connections for each channel of the XR 1600F. Most features are common to all channels; however, there are some differences in channels 15 through 20. Therefore, this section is divided to properly indicate those differences.

### CHANNELS 1-14

#### (Rear Panel)

#### 26. MIC INPUT

XLR balanced, low impedance channel input optimized for a microphone or other low-level source. Pin 2 is the positive phase input. Because of the wide range of gain adjustment, signal levels as high as +10 dBV (2.45V RMS) can be accommodated. When the phantom power is enabled, this connector has +48V on Pins 2 and 3 with Pin 1 as the ground reference.

#### 27. LINE INPUT

1/4" balanced TRS line level input. The tip is the positive (in phase) input, which can also be used for unbalanced inputs. This signal is connected through a 20 dB pad to the mic input below it. Within the same channel, the Mic Input and the Line Input should not be used simultaneously. Channels 15 through 18 feature stereo versions of the LINE INPUT. (See features 36 and 37.)

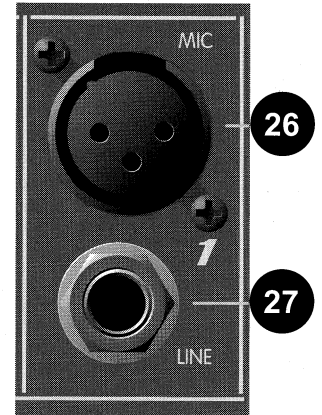

## (Front Panel)

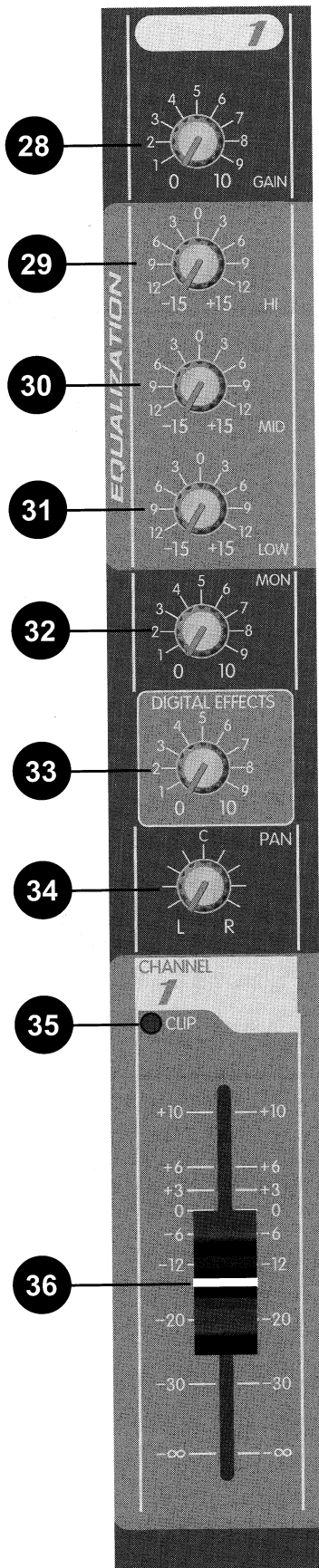

### 28. GAIN

Varies the input gain to each channel. Proper adjustment of the input gain will maximize the signal to noise ratio giving you the quietest operation. With your CHANNEL FADER (36) set to the "0" position, set this control so that the CLIP LED (35) barely lights at the highest peaks in your input signal.

### 29. HIGH EQ

A shelving type of active tone control that varies the treble frequency levels  $\pm 15$  dB at 12 kHz. It is designed to remove noise or to add brilliance to the signal, depending on the quality of the source. (The high control can also be found on Channels 15 through 20.)

### 30. MID EQ

Mid  $\pm 15$  dB. This control sets the amount of cut and boost at the mid-frequency. (The mid control can also be found on Channels 15 through 18.)

### 31. LOW EQ

A shelving type of active tone control that varies the bass frequency levels  $\pm 15$  dB at 70 Hz. It will add depth to thin signals, or clean up muddy ones. (The low control can also be found on Channels 15 through 20.)

**32. Mon:** Adjusts the level of the channel signal (pre-EQ) that is added to the Monitor mix. (The Monitor control can also be found on Channels 15 through 20.) This control is independent of the main CHANNEL FADER (36).

**33. DIGITAL EFFECTS:** This control varies the level into the digital effects processor bus by adjusting the signal level from the particular channel to the digital processor. The channel GAIN (28) control also affects this level. (The Digital Effects control can also be found on Channels 15 through 20.)

**34. PAN:** Sets the channel's position in the L/R stereo field. In the stereo channels (15/16, 17/18 and 19/20) this control acts as a balance control.

**35. CLIP LED:** Indicates when the signal input is too strong and signal clipping is present.

**36. CHANNEL FADER:** Sets the signal level sent to the Left and Right bus. (This feature can also be found on Channels 15 through 20.)

## STEREO CHANNELS 15/16 and 17/18

Channels 15 through 18 contain features that differ from the previous channels. Only those features are mentioned below. The rear panel input features for these channels are described below. Refer to the previous section for the features not described here.

### 37. RIGHT INPUT:

High impedance 1/4" input for line level signals. The Right Input is not adjusted by the GAIN (28) control. The signal is then routed to the internal power amp. If the XR 1600F is in Left/Right mode then the signal will go to the RIGHT SPEAKER OUTPUT (4). In Mon/L+R mode the signal is combined with the Left and placed on the L+R Speaker Output. The right signal can also be patched out of the XR 1600F via the RIGHT MIXER OUTPUT jack (7) to external components such as effects, power amps, and recording devices. This feature is only found on Channels 15/16 and 17/18.

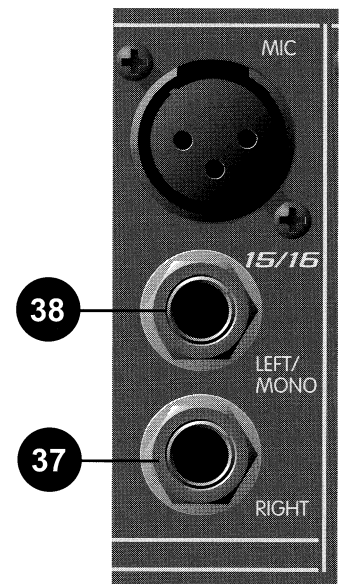

### 38. LEFT/MONO INPUT:

High impedance 1/4" input for line level signals. The LEFT/MON INPUT is not controlled by the GAIN (28) control. The LEFT/MON INPUT supplies signal to both the Left and Right channels (if there is nothing inserted to the right input jack). In Left/Right mode the signal will go to the LEFT SPEAKER OUTPUT (7) and RIGHT SPEAKER OUTPUT if nothing is inserted into the RIGHT INPUT (37) jack. In Mon/L+R mode the signal is combined with the Right and placed on the L+R SPEAKER OUTPUT (7). This feature is only found on Channels 15/16 and 17/18.

## STEREO CHANNEL 19/20

Stereo Channel 19/20 contains features that differ from the previous channels. Only those features are mentioned below.

### 39. TAPE IN:

This stereo RCA phono jack accepts a stereo input (nominally -10 dBV) from the output of a tape deck or CD player and places it on the Left and Right channels as well as the monitor mix.

### 40. TAPE OUT:

This stereo RCA phono jack provides a signal for the recording inputs of a stereo tape deck.

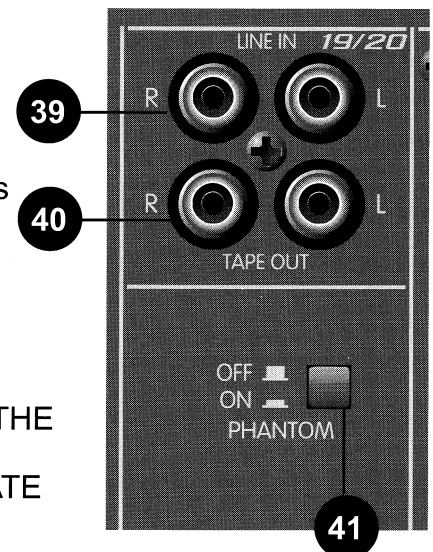

**CAUTION!** DO NOT HOOK THE TAPE IN AND TAPE OUT TO THE INPUT AND OUTPUT OF THE SAME DECK. DOING SO WILL FORM A LOOP CAUSING SEVERE FEEDBACK. USE SEPARATE DECKS FOR RECORDING AND PLAYBACK.

### PHANTOM POWER (Rear Panel)

#### 41. PHANTOM POWER SWITCH:

Applies 48V DC voltage to **all** input XLR connectors to power microphones that require it.

**CAUTION!** When phantom power is switched on, make sure that any channel you are plugging a mic into is turned down in both the main and monitor mixes. Otherwise, there will be a loud pop in the PA. This is normal. It is best to plug all mics into their respective channels with the phantom power switched off. This reduces noise in the PA and reduces the chances of the mic being damaged. If phantom power is used, do not connect unbalanced microphones or other devices that cannot handle this voltage to the XLR inputs. (Some wireless receivers may be damaged; consult their manuals for compatibility.) The line input 1/4" jacks are not connected to the phantom supply, and are safe for all inputs (balanced or unbalanced). An unbalanced-to-balanced impedance converter, such as the Peavey 5116 or a Peavey 1:1 Interface Adapter, can also be used to isolate a mic from phantom voltage.

# XR 1600F BLOCK DIAGRAM

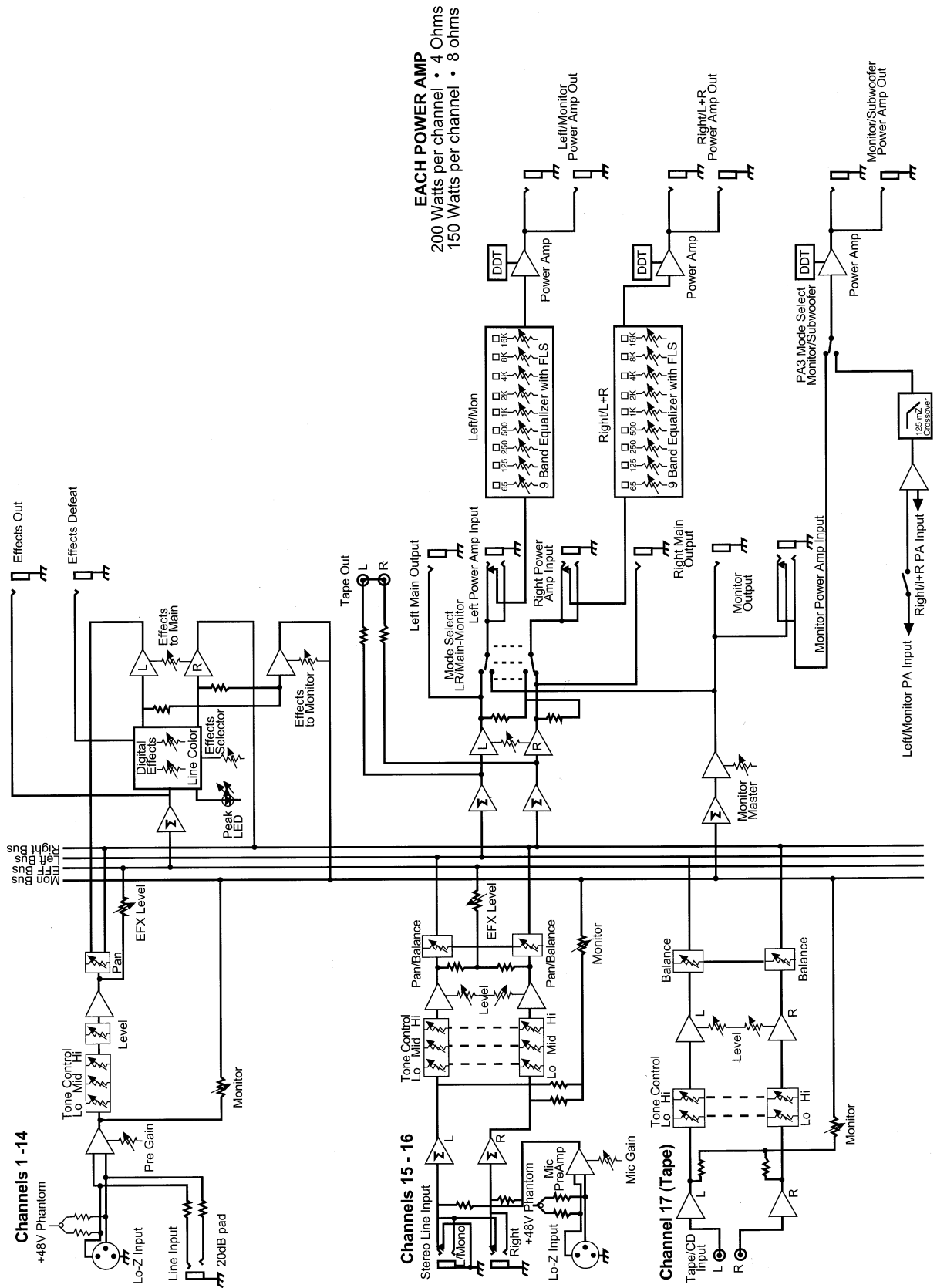

# XR 1600F LEVEL DIAGRAM

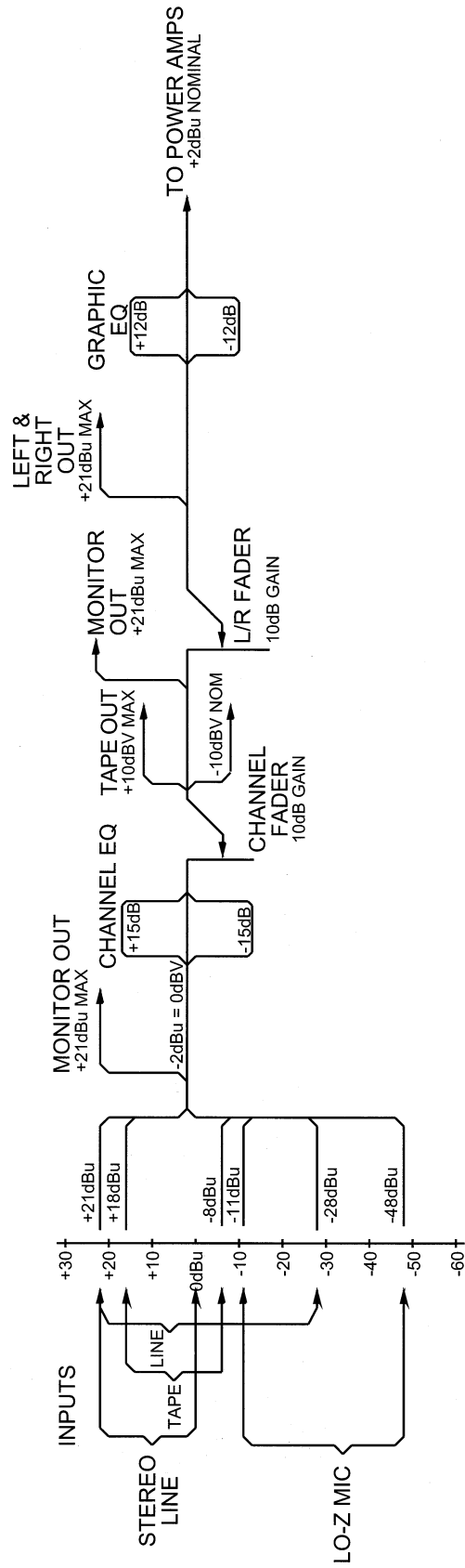

# XR 1600F

## HOOKUP DIAGRAMS

**FULL PA SUPPORT  
SUPPLIED BY XR®1600F**  
(MAINS, MONITOR, AND SUBWOOFER)

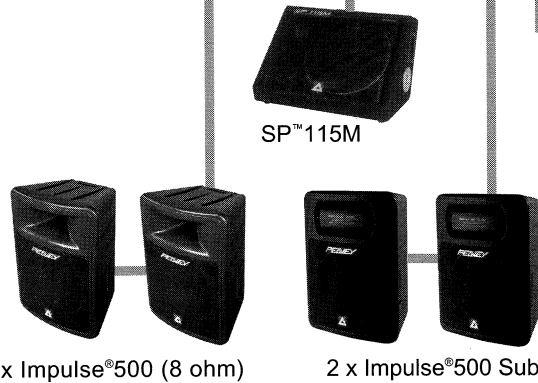
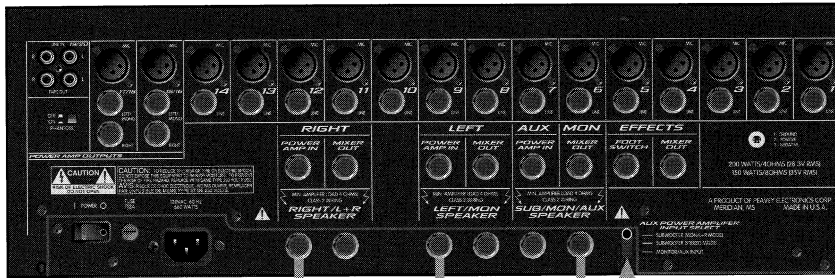

This switch must be in the SUBWOOFER/ (MON/L+R MODE) position and the System Mode Switch on the front of the unit must be in the Mon/L+R Mode position.

This position will render the following:

RIGHT/L+R Speaker Output =	L+R (sum)
LEFT/MON Speaker Output =	Monitor channel
SUB/MON/AUX Speaker Output =	Sub (L+R)

**STEREO PA WITH SUBWOOFER  
and EXTERNAL MONITOR SYSTEM SUPPORT**  
SUPPLIED BY XR®1600F  
(STEREO L&R MAINS AND MONO L+R SUBWOOFER w/MONITOR SEND)

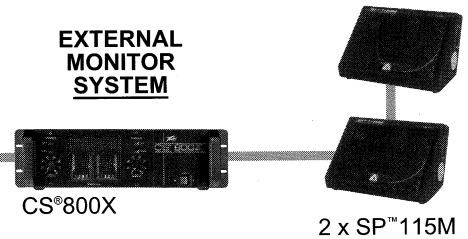
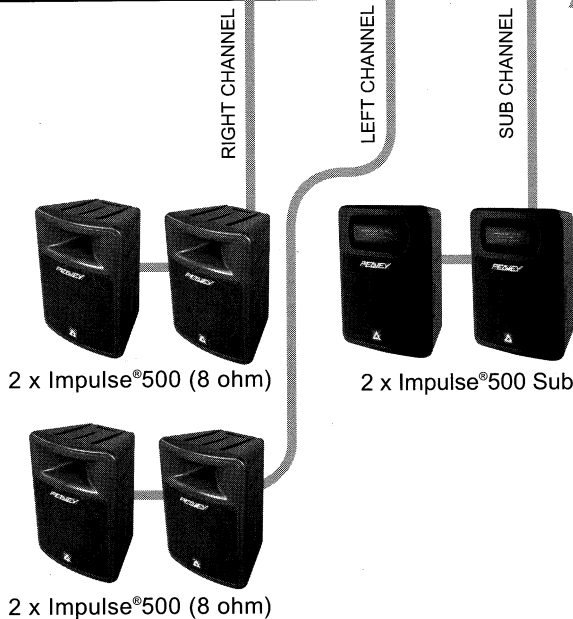
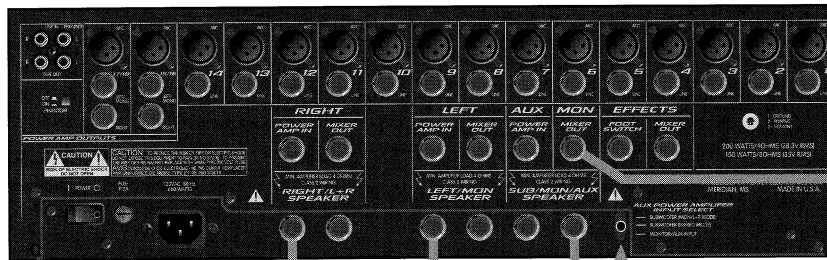

This switch must be in the SUBWOOFER/(STEREO MODE) position and the System Mode Switch on the front of the unit must be in the LEFT/RIGHT Mode position.

This position will render the following:

RIGHT/L+R Speaker Output=	RIGHT channel
LEFT/MON Speaker Output=	LEFT channel
SUB/MON/AUX Speaker Output=	Sub (L+R)



# XR 1600F HOOKUP DIAGRAMS

## STEREO PA WITH MONITORS SUPPLIED BY XR1600F (STEREO L&R MAINS AND MONITOR)

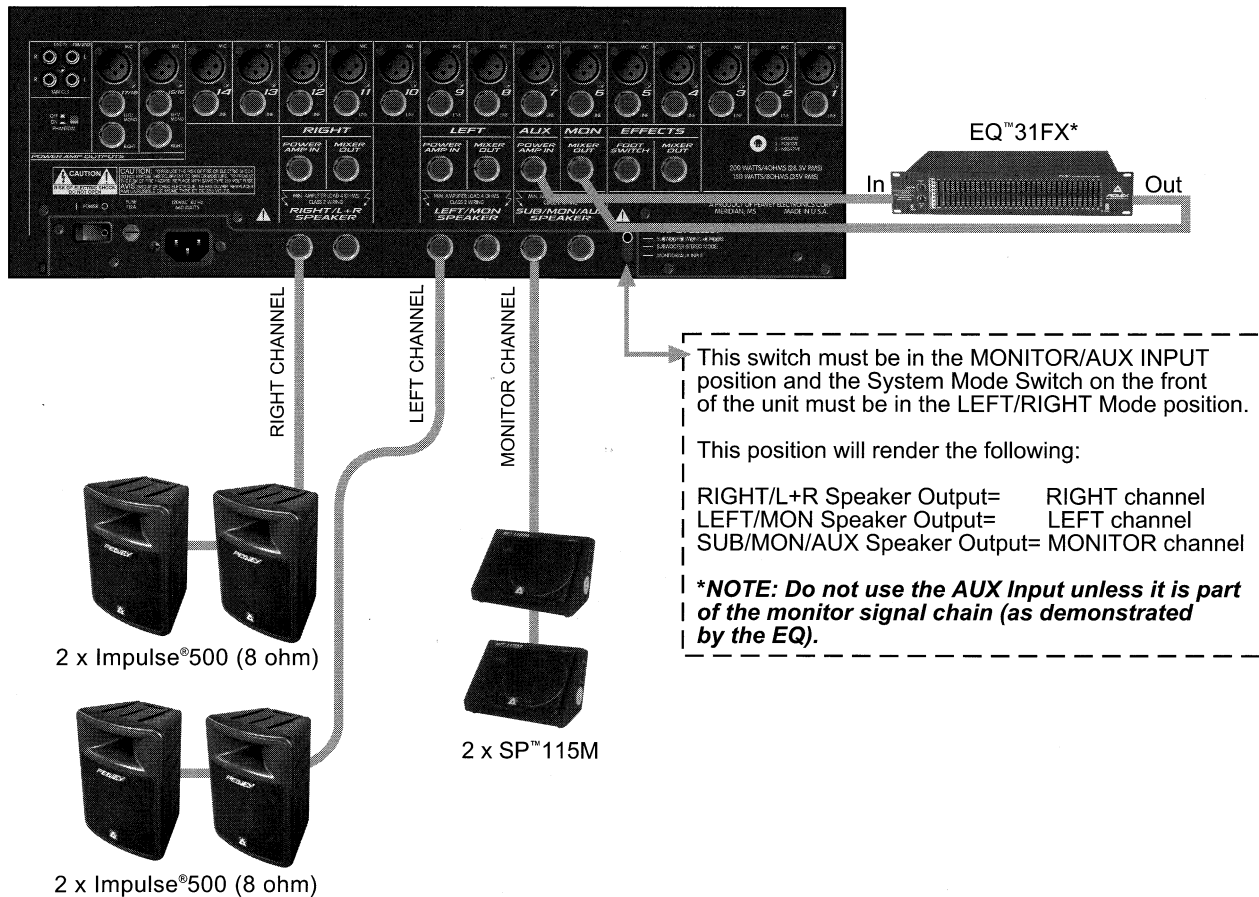

## MONO PA, MONITORS and AUX INPUT/AMP SUPPLIED BY XR1600F (MONO L&R MAINS, MONITORS and EXTRA AMP)

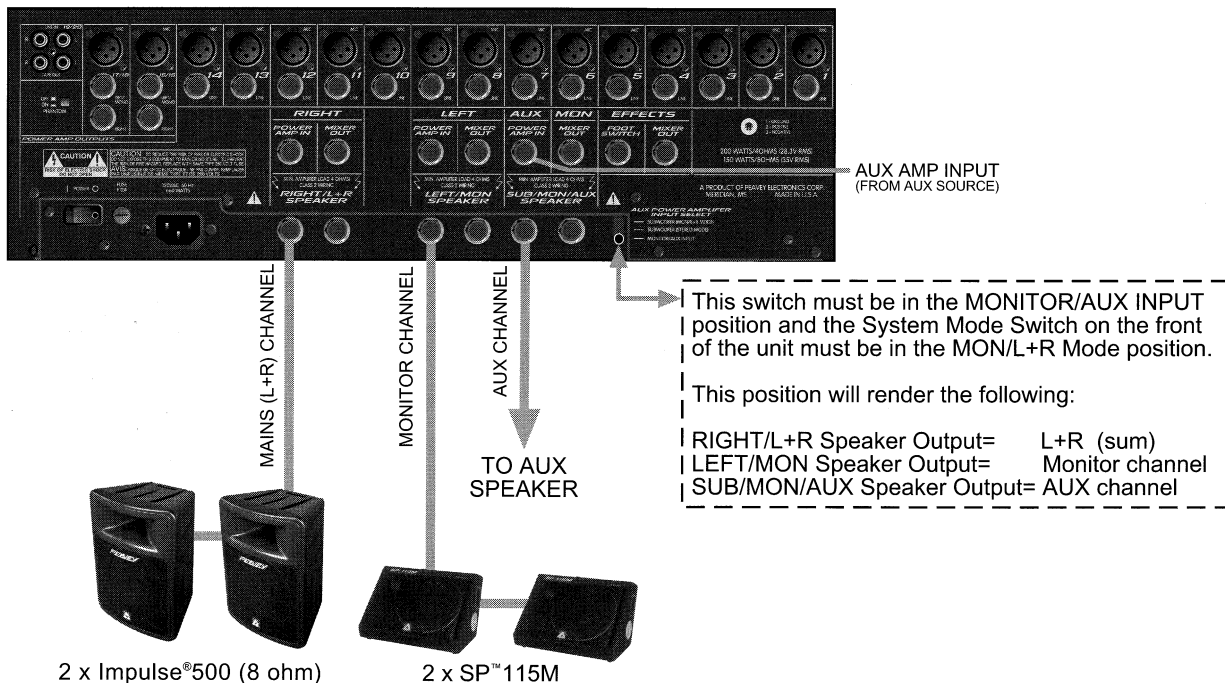

# XR 1600F Specifications

## Input Specifications:

Function	Input Z (Ohms) Min	Input Gain	Input Levels			Bal/Unbal	Connector
			Min**	Nominal*	Max		
LOW-Z Mic (150 Ohms)	2.2 K	Max (48 dB)  Min (10 dB)	-68 dBu  -30 dBu	-48 dBu  -10 dBu	-27 dBu  +11 dBu	Bal	XLR Pin 1 Gnd Pin 2 (+), Pin 3 (-)
Line Input Channels 1-6	22 K	Max (29 dB) Min (-10 dB)	-49 dBu  -11 dBu	-290 dBu  +10 dBu	+8 dBu  +31 dBu	Unbal	1.4" TRS; Tip (+) Ring (-) Sleeve Ground
Stereo Line Inputs Ch 7-8	22 K	Max Gain 20 dB	-20 dBu	0 dBu	+21 dBu	Unbal	1/4" Phono Tip (+) Sleeve Ground
Tape	20 K	Max Gain	-26 dBu	-6 dBu	+16 dBu	Unbal	RCA Jacks

0 dBu = 0.775 V (RMS)

\*\* Min input level (Sensitivity) is the smallest signal that will produce nominal output (2 dBu) with channel and master controls set for maximum gain.

\* Nominal settings are defined as all controls set at 0 dB (or 50% rotation for rotary pots).

## Output Specifications:

Function	Minimum Load Z (Ohms)	Output Level		Bal/Unbal	Connector
		Nominal	Max		
Main L/R	600	+2 dBu	+21 dBu	Unbal	1/4" Phono Tip (+), Sleeve Ground
Monitor	600	+2 dBu	+21 dBu	Unbal	1.4" Phono Tip (+), Sleeve Ground
Effects	600	+2 dBu	+21 dBu	Unbal	1/4" Phono Tip (+), Sleeve Ground
Tape	10 k	-10 dBu	+10 dBu	Unbal	RCA

+2 dBu = 0 dBV = 1V (RMS)

## Gain:

Mic Input Adjustment Range:	10 dB to 48 dB
Mic input to L & R Output	68 dB (Max Gain)
Mic Input longest path	96 dB (Max Gain) power amp out

Line Input Adjustment Range:	-10 dB to 28 dB
Line Input to L & R Output	49 dB (Max Gain)
Line Input to longest path	77 dB (Max Gain) power amp out

**Frequency Response:**

Mic Input to L-R Output	20 Hz to 20 kHz +0 dB / -1dB
Line Input to L-R Output	20 Hz to 20 kHz +0 dB / -1dB
To Power Amplifier Output	20 Hz to 20 kHz +0 dB / -1dB

**Total Harmonic Distortion (THD):**

<0.01% 20 Hz to 20 kHz Mic Input to L/R/Mon output at Nominal Level (20 Hz - 80 kHz BW)  
 <0.01% 2 Hz to 20 kHz Line Input to L/R/Mon output at Nominal Level (20 Hz - 80 kHz BW)  
 <0.005% Typical at 1 kHz

**Graphic Equalizer:**

Filter Bandwidth	1 octave
Filter Frequencies	63, 125, 250, 500, 1 k, 2 k, 4 k, 8 k, 16 k
Maximum Boost and Cut	+12 dB Boost, -12 dB Cut

**Hum and Noise:**

Output	Residual Noise Ref: 0 dBu	S/N Ratio Ref: 0 dBu	Test Conditions
Main Left and Right	-100 dBu	100 dB	All faders down
	-89 dBu	89 dB	Master fader nominal, channel faders down
	-84 dBu	84 dB	All controls nominal, mic gain minimum
Monitor	-100 dBu	100 dB	All controls down
	-90 dBu	90 dB	Master fader nominal, channel sends down
	-81 dBu	-81 dB	Master Fader Nominal, Channel Send Nominal
Effects	-87 dBu	87 dB	All channel sends down
	-80 dBu	80 dB	All channel sends nominal

**S/N Ratio:**

>85 dB below rated output (200W/channel), Mic/Line to Speaker Output

**Equivalent Input Noise (EIN):**

-128.5 dBu (Input terminated with 150 Ohms)

**Crosstalk:**

>80 dB Adjacent Input Channels (20 Hz - 20 kHz)  
 >70 dB Left to Right Outputs (20 Hz - 20 kHz)

**Common Mode Rejection Ratio (Mic Input):**

50dB min (20 Hz - 20 kHz)

60dB typ @ 1 kHz

**Power Amplifier Specifications: 604 Module with DDT**

**Power and Load:**

200W RMS per channel into 4 ohms

150W RMS per channel into 8 ohms

**Frequency Response:**

20 Hz – 20 kHz +0 dB/-1 dB

**Total Harmonic Distortion (THD):**

< 0.02% at rated output @ 1 kHz

**DDT Dynamic Range:**

Greater than 26 dB

**DDT Maximum Distortion:**

Below 0.5% THD for 6 dB overload

Below 1% THD for 20 dB overload

**Hum and Noise**

-100 dB below 200 Watts

**Damping Factor:**

Greater than 100 @ 1 kHz, 4 ohms

**Input Impedance:**

2 kohms

**Power Requirements:**

DOM: 120VAC 60 Hz

660 Watts Nominal

EXP: 220-230VAC/240VAC 50/60 Hz

660 Watts Nominal

# PEAVEY ELECTRONICS CORPORATION LIMITED WARRANTY

Effective Date: July 1, 1998

## What This Warranty Covers

Your Peavey Warranty covers defects in material and workmanship in Peavey products purchased and serviced in the U.S.A. and Canada.

## What This Warranty Does Not Cover

The Warranty does not cover: (1) damage caused by accident, misuse, abuse, improper installation or operation, rental, product modification or neglect; (2) damage occurring during shipment; (3) damage caused by repair or service performed by persons not authorized by Peavey; (4) products on which the serial number has been altered, defaced or removed; (5) products not purchased from an Authorized Peavey Dealer.

## Who This Warranty Protects

This Warranty protects only the original retail purchaser of the product.

## How Long This Warranty Lasts

The Warranty begins on the date of purchase by the original retail purchaser. The duration of the Warranty is as follows:

Product Category	Duration
Guitars/Basses, Amplifiers, Pre-Amplifiers, Mixers, Electronic Crossovers and Equalizers	2 years *(+ 3 years)
Drums	2 years *(+ 1 year)
Enclosures	3 years *(+ 2 years)
Digital Effect Devices and Keyboard and MIDI Controllers	1 year *(+ 1 year)
Microphones	2 years
Speaker Components (incl. speakers, baskets, drivers, diaphragm replacement kits and passive crossovers) and all Accessories	1 year
Tubes and Meters	90 days

[\*denotes additional warranty period applicable if optional Warranty Registration Card is completed and returned to Peavey by original retail purchaser within 90 days of purchase.]

## What Peavey Will Do

We will repair or replace (at Peavey's discretion) products covered by warranty at no charge for labor or materials. If the product or component must be shipped to Peavey for warranty service, the consumer must pay initial shipping charges. If the repairs are covered by warranty, Peavey will pay the return shipping charges.

## How To Get Warranty Service

(1) Take the defective item and your sales receipt or other proof of date of purchase to your Authorized Peavey Dealer or Authorized Peavey Service Center.

**OR**

(2) Ship the defective item, prepaid, to Peavey Electronics Corporation, International Service Center, 412 Highway 11 & 80 East, Meridian, MS 39301 or Peavey Canada Ltd., 95 Shields Court, Markham, Ontario, Canada L3R 9T5. Include a detailed description of the problem, together with a copy of your sales receipt or other proof of date of purchase as evidence of warranty coverage. Also provide a complete return address.

## Limitation of Implied Warranties

ANY IMPLIED WARRANTIES, INCLUDING WARRANTIES OF MERCHANTABILITY AND FITNESS FOR A PARTICULAR PURPOSE, ARE LIMITED IN DURATION TO THE LENGTH OF THIS WARRANTY.

**Some states do not allow limitations on how long an implied warranty lasts, so the above limitation may not apply to you.**

## Exclusions of Damages

PEAVEY'S LIABILITY FOR ANY DEFECTIVE PRODUCT IS LIMITED TO THE REPAIR OR REPLACEMENT OF THE PRODUCT, AT PEAVEY'S OPTION. IF WE ELECT TO REPLACE THE PRODUCT, THE REPLACEMENT MAY BE A RECONDITIONED UNIT. PEAVEY SHALL NOT BE LIABLE FOR DAMAGES BASED ON INCONVENIENCE, LOSS OF USE, LOST PROFITS, LOST SAVINGS, DAMAGE TO ANY OTHER EQUIPMENT OR OTHER ITEMS AT THE SITE OF USE, OR ANY OTHER DAMAGES WHETHER INCIDENTAL, CONSEQUENTIAL OR OTHERWISE, EVEN IF PEAVEY HAS BEEN ADVISED OF THE POSSIBILITY OF SUCH DAMAGES

**Some states do not allow the exclusion or limitation of incidental or consequential damages, so the above limitation or exclusion may not apply to you.**

**This Warranty gives you specific legal rights, and you may also have other rights which vary from state to state.**

If you have any questions about this warranty or service received or if you need assistance in locating an Authorized Service Center, please contact the Peavey International Service Center at (601) 483-5365 / Peavey Canada Ltd. at (905) 475-2578.

Features and specifications subject to change without notice.



Features and specifications subject to change without notice.

Peavey Electronics Corporation • 711 A Street • Meridian • MS • 39301  
(601) 483-5365 • FAX (601) 486-1278 • [www.peavey.com](http://www.peavey.com)



80304765

©2001

Printed in the U.S.A.4/01

## Free Manuals Download Website

<http://myh66.com>

<http://usermanuals.us>

<http://www.somanuals.com>

<http://www.4manuals.cc>

<http://www.manual-lib.com>

<http://www.404manual.com>

<http://www.luxmanual.com>

<http://aubethermostatmanual.com>

Golf course search by state

<http://golfingnear.com>

Email search by domain

<http://emailbydomain.com>

Auto manuals search

<http://auto.somanuals.com>

TV manuals search

<http://tv.somanuals.com>