

owner's manual

(PRELIMINARY COPY)



X-VCA mixing consoles



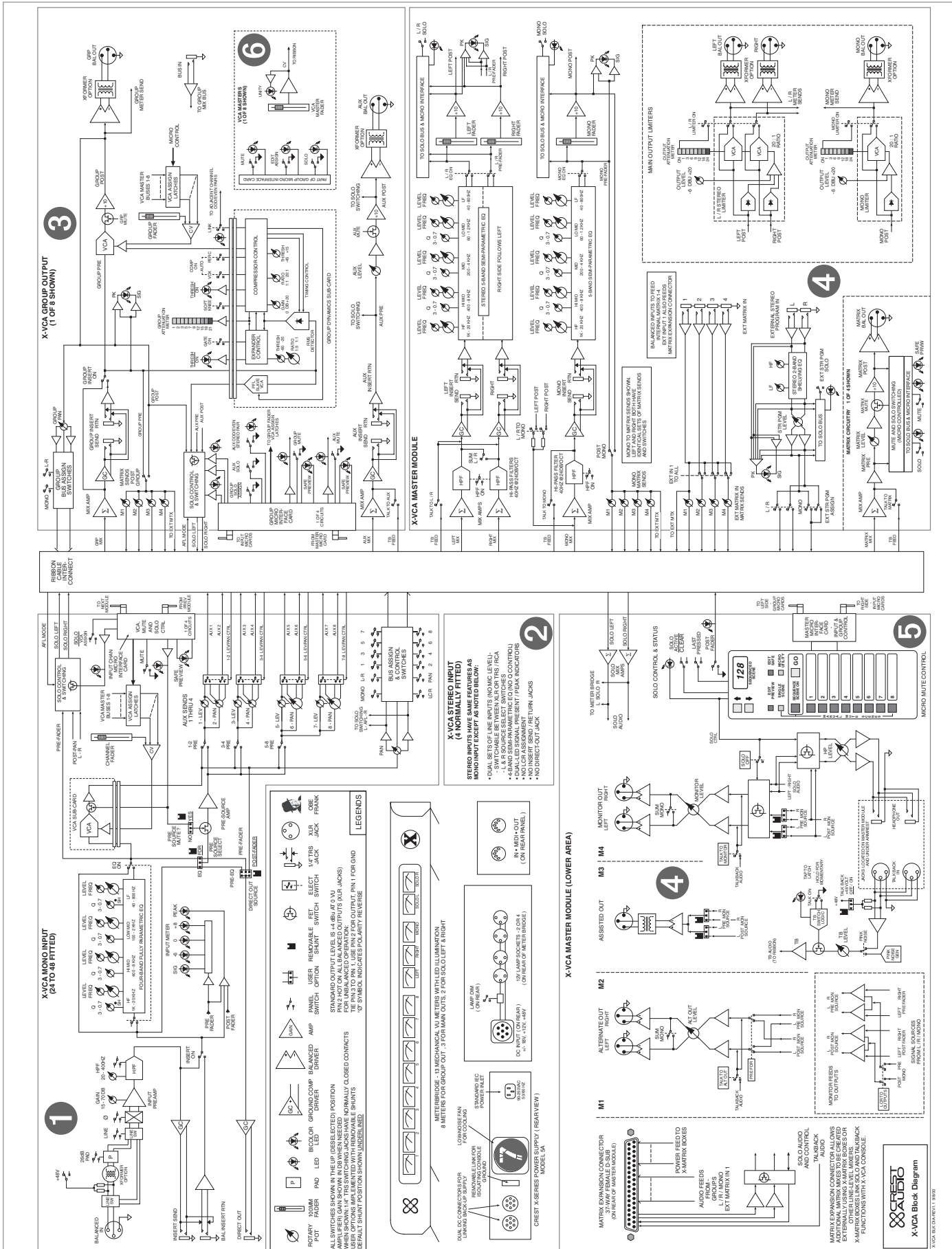

table of contents

mono input module Mic and line inputs	p. 7	1
stereo input module Line inputs and stereo returns	p. 27	2
group module VCA groups, audio groups, dynamics, matrix and Aux masters	p. 43	3
left, right & mono masters	p. 59	4
master control section	p. 71	5
microprocessor control	p. 89	6
vca facilities	p. 107	7
solo/vca edit switch	p. 129	8
dynamics control	p. 131	9
power supply	p. 139	10



how to use this manual

format

This manual uses a format that is intended to be easy to read, yet technical for those who need to know all the details. For feature descriptions, this is done by devoting the left side of each page to 1) an overall module picture, 2) a block diagram, and 3) a control closeup. These images all pertain to the features and control descriptions on the right side of the page. Also, for certain features like the micro processor system and the solo system that appear over and over again, references are made to sections devoted to these features.

The intention is to make the manual easy to read while including all the technical details needed for getting the most out of the X-VCA console, a flexible and feature-rich addition to Crest Audio's growing line of audio mixing console products.

conventions

Control Icons

This manual uses little pictures, or icons to illustrate what the control descriptions are referring to. This makes it possible to avoid redundant wording and makes the control descriptions clear:

 Switch in the UP, non-activated position

 Switch in DOWN, activated position

 Switch that illuminates when in the DOWN position

 Momentary switch that illuminates when activated

 LED that is on, indicating that it's associated feature is activated

 Potentiometer

 Standard 1/4" TRS jack (used for line level inputs and insert sends)

 1/4" TRS jack with normal switching (used on insert returns)

 Female XLR input jack

 Male XLR output jack

1 mono input module

module



block diagram

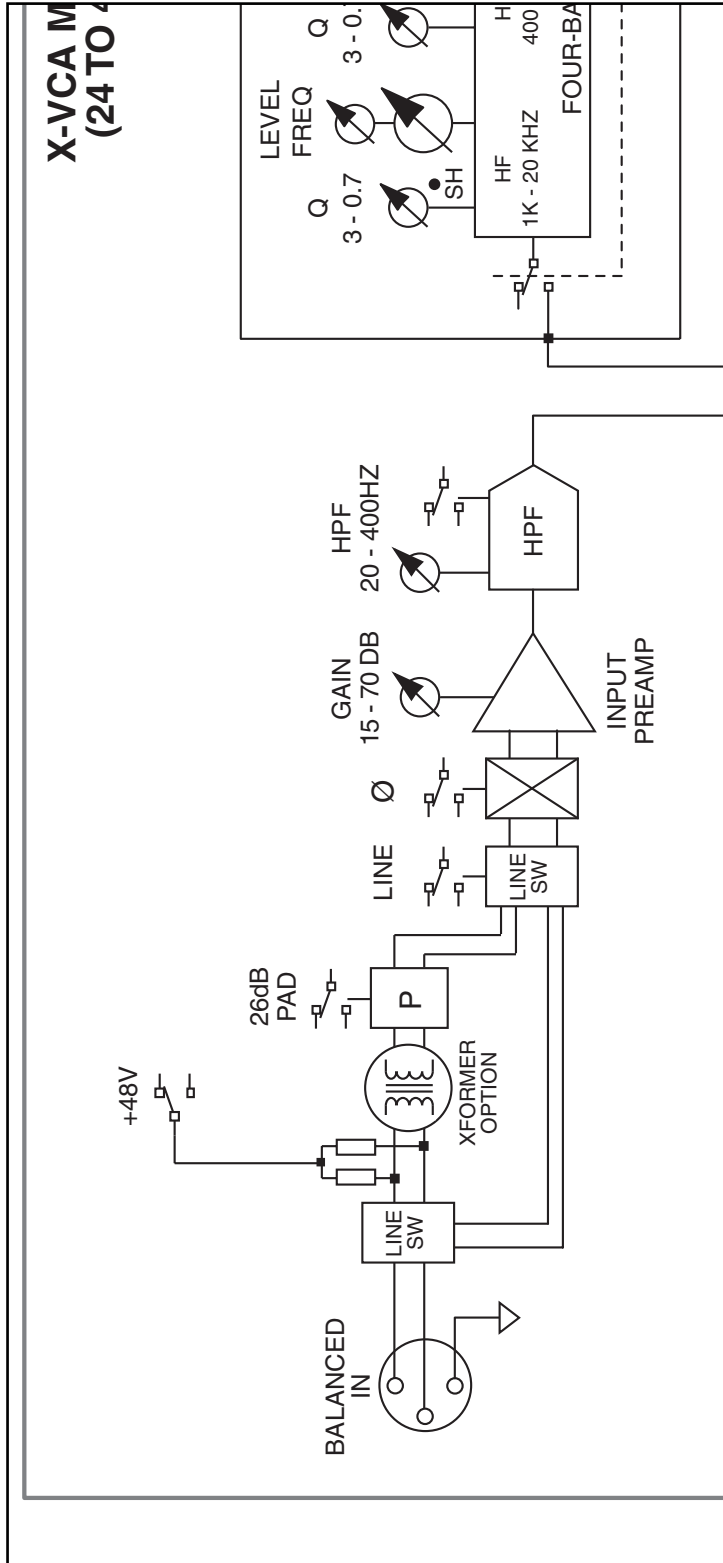

panel

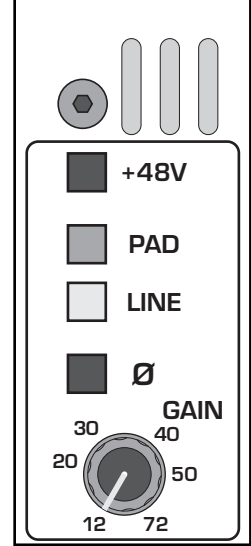

features

phantom power +48V

 48 volts DC is applied to pins 2 and 3 on the mic-input XLR connector. This option is used with condenser microphones and active direct boxes that require an external DC voltage (phantom power) in order to operate.

pad

 The mic-input signal is attenuated by 20dB to prevent some signals (e.g. kick drum or lead vocal) from overloading the preamp stage. The pad is used to bring a hot mic-input signal down to a controllable level. The 20dB pad is not functional when the LINE switch is depressed.

line

 The input preamp circuit is set up to accept a mic-level signal. This signal is brought in via the XLR mic-input connector located on the rear panel. The 1/4" TRS input jack is disabled.

 The input preamp circuit is set up to accept a line-level signal from either the XLR mic-input connector or the 1/4" TRS input jack, both located on the rear panel. When a plug is inserted into the 1/4" TRS input jack, the XLR mic-input connector is disabled.

polarity reverse— \emptyset

This feature is used for correcting or minimizing polarity and phase related errors. For example, occasionally a balanced input connection is reverse-wired before it gets to the mixing console. This can happen in microphones, or in snake line interfaces. By using the polarity reverse feature, this type of error can be corrected.

 polarity inverted

 polarity not inverted

 The 48V switch should not be engaged when using standard (dynamic) microphones, or other sources that do not use phantom power.

 If the 48V phantom power switch is engaged, depressing this switch disconnects phantom power from the mic input XLR.

 When similar signals from different channels are combined, phase cancellations can occur. Reversing the polarity of an input signal often corrects such phasing errors.

1 mono input module

module

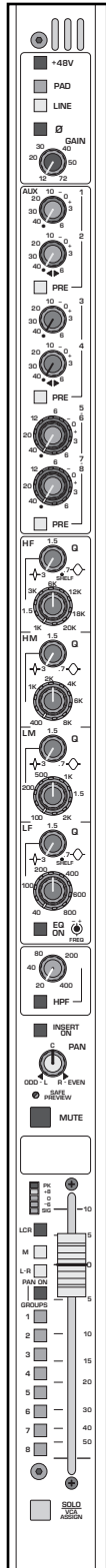

block diagram

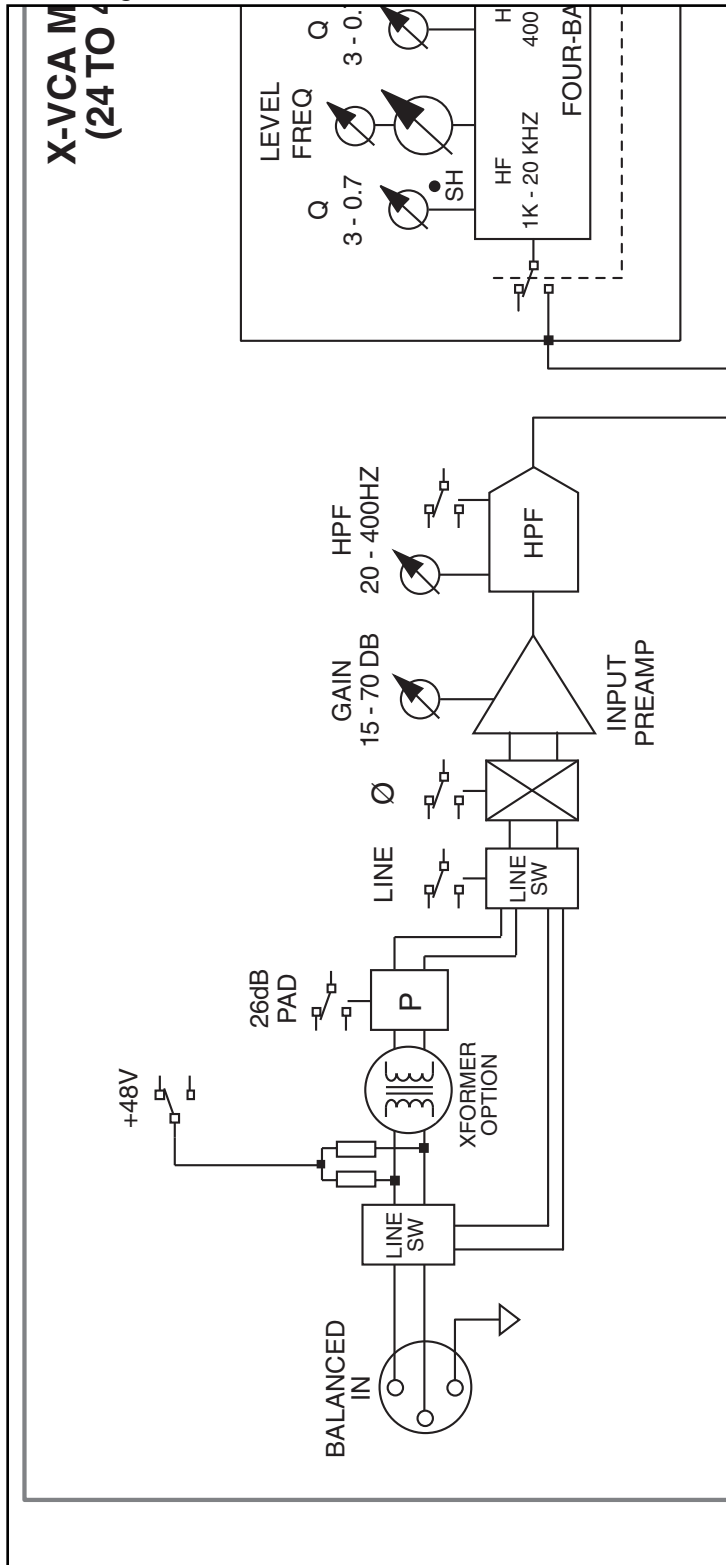

panel

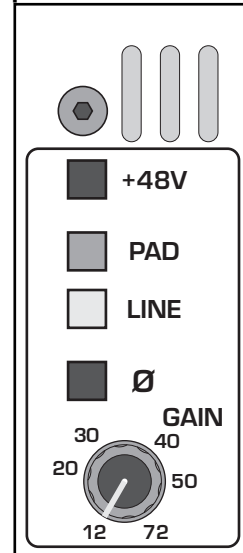

features

gain

The Input gain control range is closely related to the status of the PAD switch and the LINE switch. In order to establish proper gain structure in the console, input gain settings must be set correctly.

 LINE—switch-up PAD—switch-up

15 to 75dB of gain can be added the mic-input signal.

The impedance at the input XLR is 4k Ω .

 LINE—switch-up PAD—switch-down

-5 to 55dB of gain can be added to the mic-input signal.

The impedance at the input XLR is 4k Ω .

 LINE—switch-down PAD—switch-up or -down

-10 to 45dB of gain can be added the line-input signal.

The impedance at the input XLR and input 1/4" TRS is 20k Ω .

If the channel peak LED is illuminated, first try lowering the input gain control.



Only when this method is unsuccessful should the pad switch be engaged.

1 mono input module

module

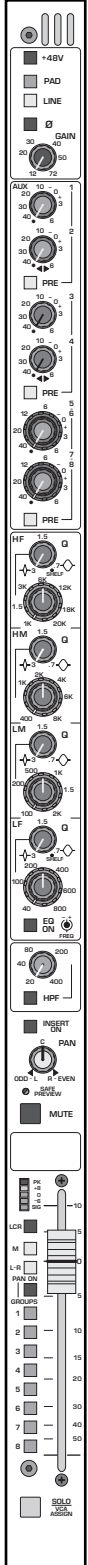

block diagram

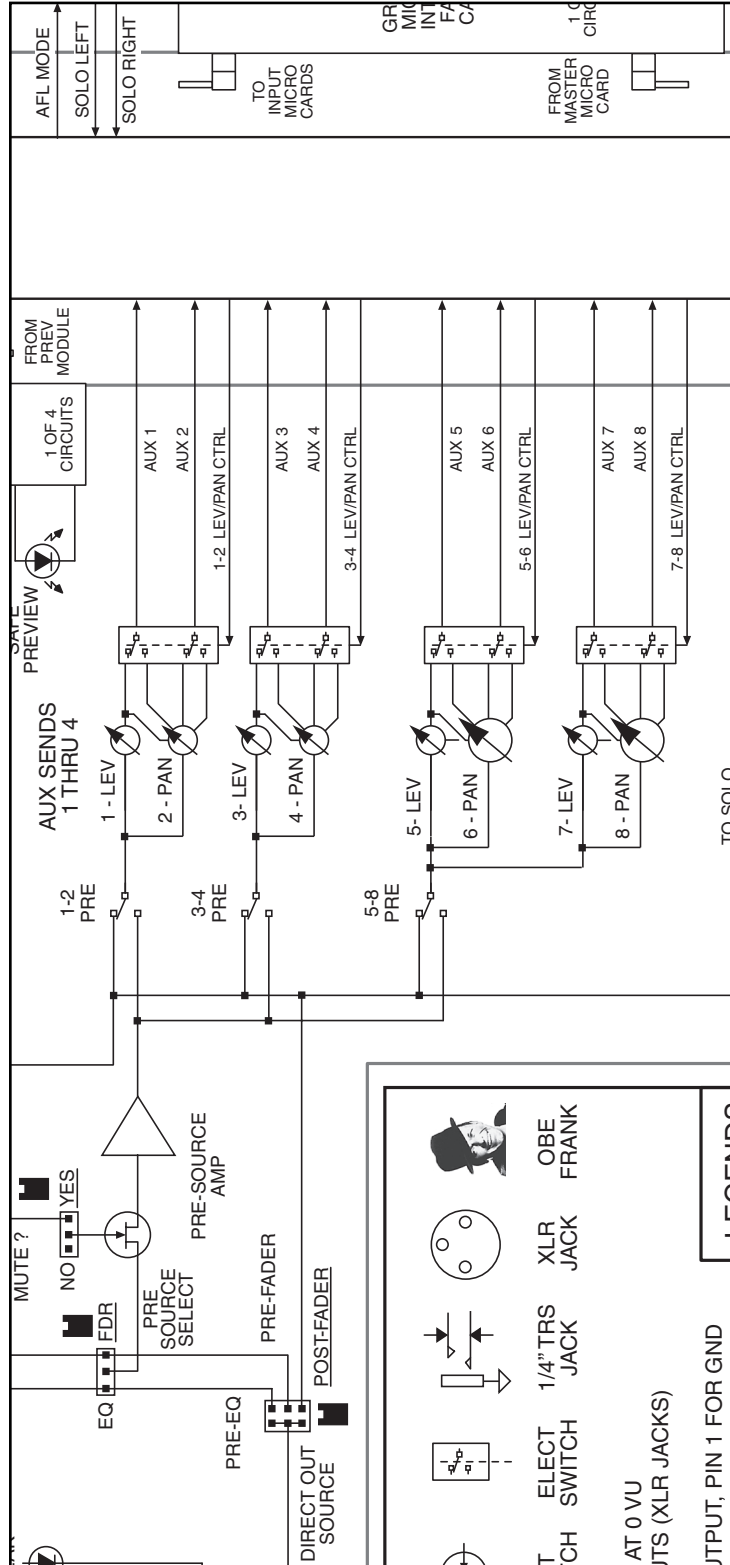

panel

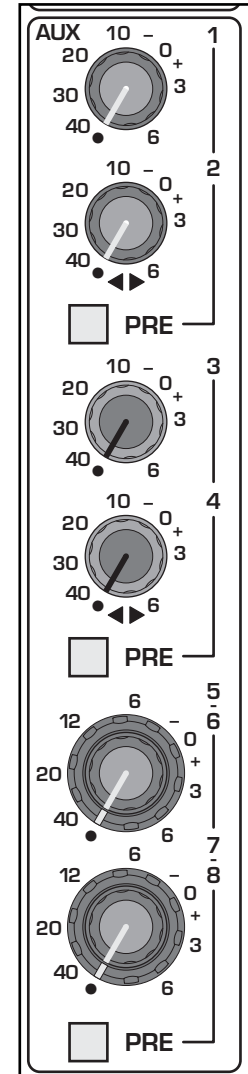

aux send features

Eight auxiliary sends are available for creating individual output mixes. These can be used to drive effects processors, provide monitor mixes, create broadcast or alternate sound reinforcement mixes, or for other special requirements. Each pair of odd/even Aux buses (1&2, 3&4, etc.) can be treated as individual discrete mono sends, or as stereo pairs. Discrete mono or stereo pair mods are selected globally for each aux pair via mode switched in the Aux master section, located at the top of the Group modules.

It's typical to make Aux sends Post fader when driving effects, and Pre fader when mixing for monitors.

Aux sends 1-2, 3-4

 These knobs adjust the amount of signal sent to the first four AUX buses. Unity gain occurs at the zero setting.

In mono mode, each control independently determines the send level for the respective aux mix. When stereo mode is selected, the top (odd numbered) control sets signal level while the bottom (even numbered) control pans the signal between odd and even auxiliary mix buses (odd = left, even = right).

Aux PRE switches 1-2, 3-4,

The Aux PRE switches determine the source for each pair of AUX sends. The signal that these switches use for the PRE setting can be further defined by changing the position of a couple of internal jumpers. See **INTERNAL JUMPER OPTIONS**.

- AUX SENDS are post-insert, post-eq, post-mute, post-fader
- AUX SENDS are post-insert, post-eq, post-mute, pre-fader

Aux sends 5-6, 7-8 (Dual Concentric)

 In mono mode, the inner knobs control levels for aux 5 and 7, respectively. The outer knobs control levels for aux 6 and 8, respectively. When stereo mode is selected for either of the odd/even aux pairs, the center knobs become the level controls and the outer knobs become the pan controls.

Aux 5-6 & 7-8 PRE switch

See "Aux PRE switches 1-2, 3-4" above. This button functions the same way, however it selects the signal source for Aux's 5, 6, 7 & 8.

1 mono input module

module

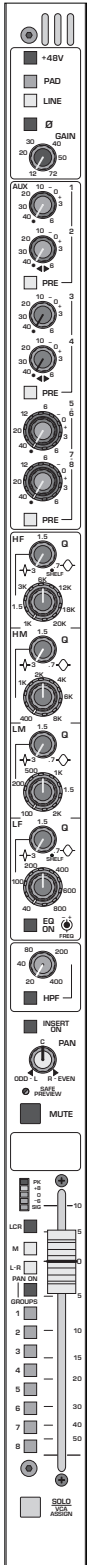

block diagram

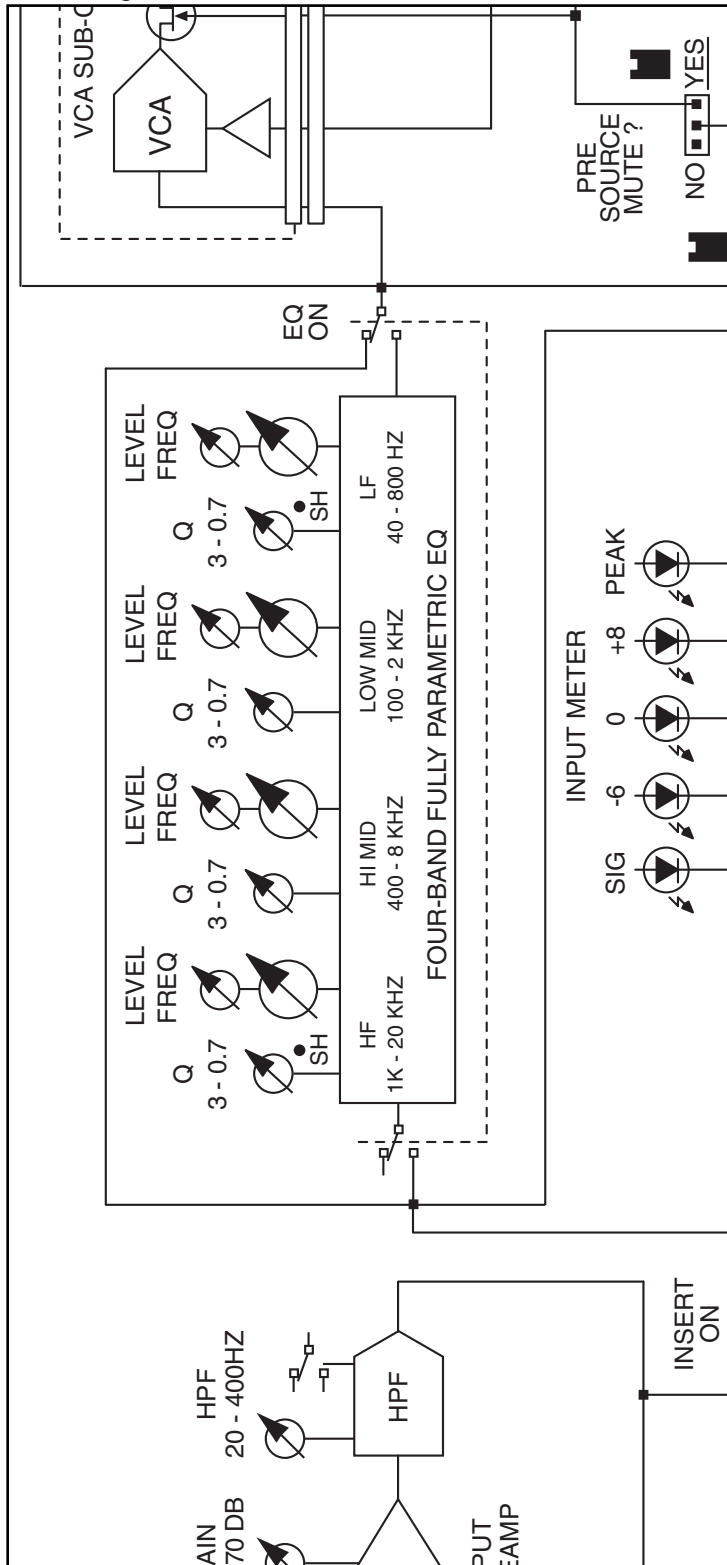

panel

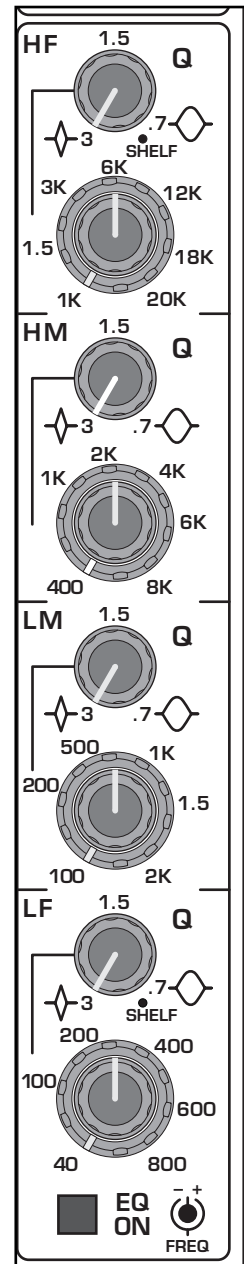



EQ features

Many audio signals coming into the console require some degree of corrective eq in order to be part of a good sounding mix. The X-VCA offers an uncompromised, full parametric EQ on each channel.

The input EQ consists of four full parametric bands: high, high-mid, low-mid, and low. The high and low bands are independently switchable for either adjustable bandwidth or shelving mode. All bands offer a generous overlap of adjacent operating frequencies. An independent, variable high pass filter provides additional problem-solving flexibility.

high frequency—HF

 **Bandwidth** A Q range of 3.0 to 0.7 (0.5 octave to 2.0 octave) is available. Turning the control full clockwise switches operation to a plus/minus shelving mode.

 **Boost / Cut** (inner knob) 15dB boost and cut.

 **Frequency** (outer knob) Continuously sweepable between 1kHz and 20kHz

high mid—HM

 **Bandwidth** A Q range of 3.0 to 0.7 (0.5 octave to 2.0 octave) is available.

 **Boost / Cut** (inner knob) 15dB boost and cut.

 **Frequency** (outer knob) Continuously sweepable between 400 Hz and 8 kHz.

Low mid—LM

 **Bandwidth** A Q range of 3.0 to 0.7 (0.5 octave to 2.0 octave) is available.

 **Boost / Cut** (inner knob) 15dB boost and cut.

 **Frequency** (outer knob) Continuously sweepable between 100 Hz and 2 kHz.

Low frequency—LF

 **Bandwidth** A Q range of 3.0 to 0.7 (0.5 octave to 2.0 octave) is available. Turning the control full clockwise switches operation to a plus/minus shelving mode.

 **Boost / Cut** (inner knob) 15dB boost and cut.

 **Frequency** (outer knob) Continuously sweepable between 40 Hz and 800 kHz.

eq on

 Equalizer is on. This switch is used to activate the EQ section and can be used to make A/B comparisons between "flat" and eq'd signals.

When boosting or cutting EQ, it is often necessary to compensate for cumulative level changes. This is best done with the Input Gain control 

1 mono input module

module

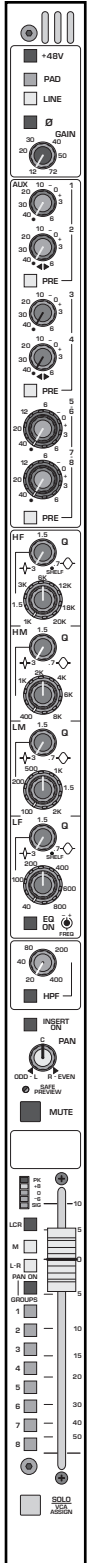

block diagram

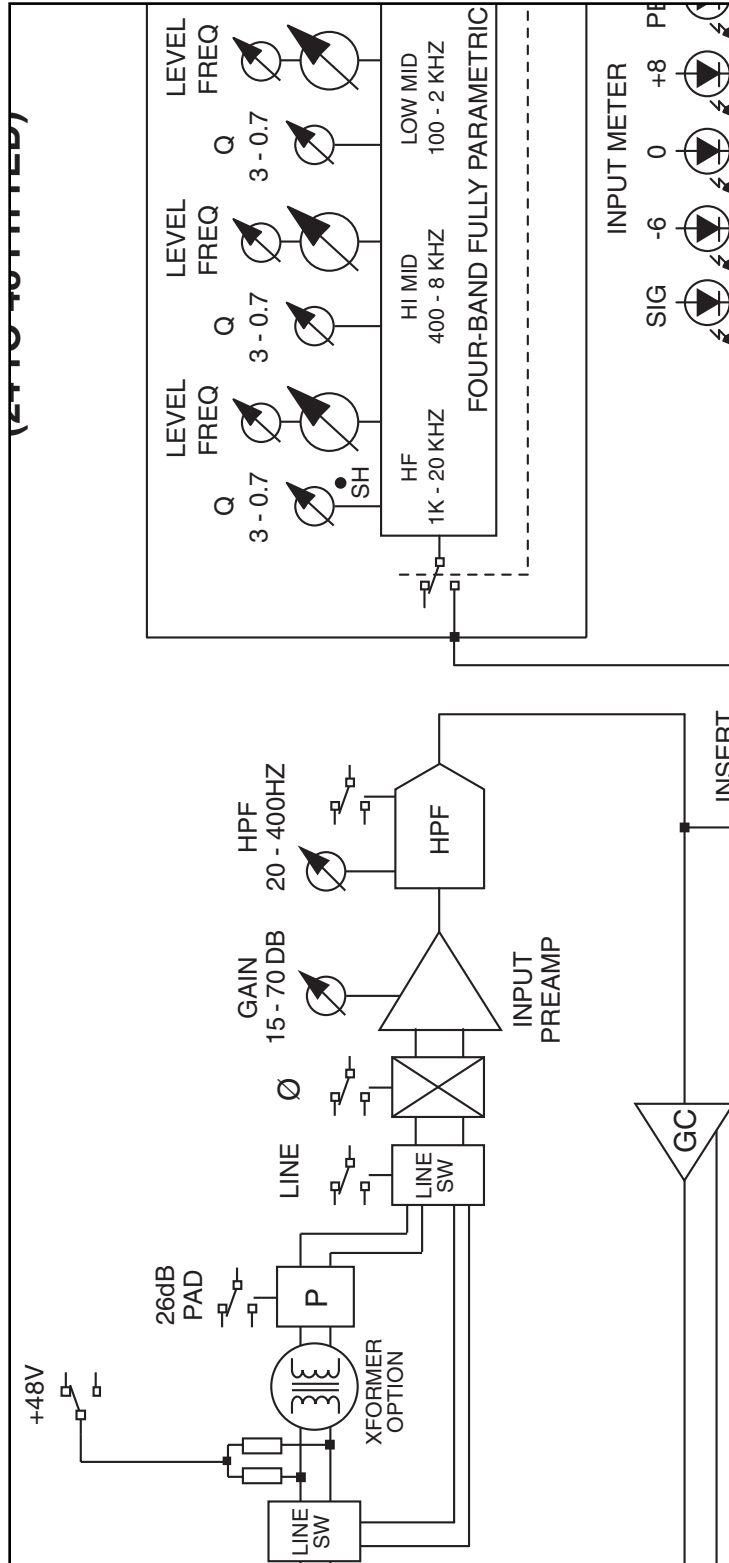

panel

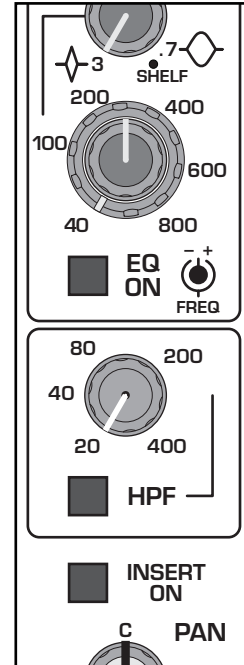

high-pass filter—HPF

Proper use of the high-pass filter reduces or eliminates unwanted low frequencies without substantially affecting the program material. Quite often such unwanted low frequencies are included with in-coming mic- or line-input signals. For example, stage rumble or wind can be picked up through vocal mics. The slope of the high-pass filter is 12dB per octave.

Many microphones have a built-in switchable high-pass filter.



HPF

 High-pass filter is on.

HPF—variable control

 When the high-pass filter is on, this control selects a frequency between 20Hz and 400Hz as the point where attenuation begins.

1 mono input module

module

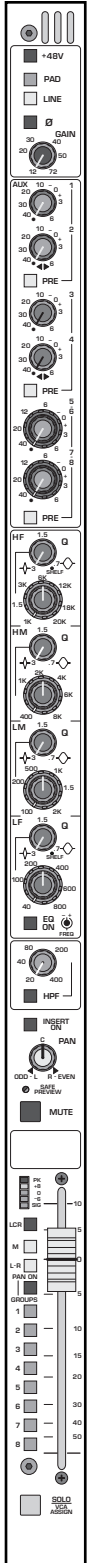

block diagram

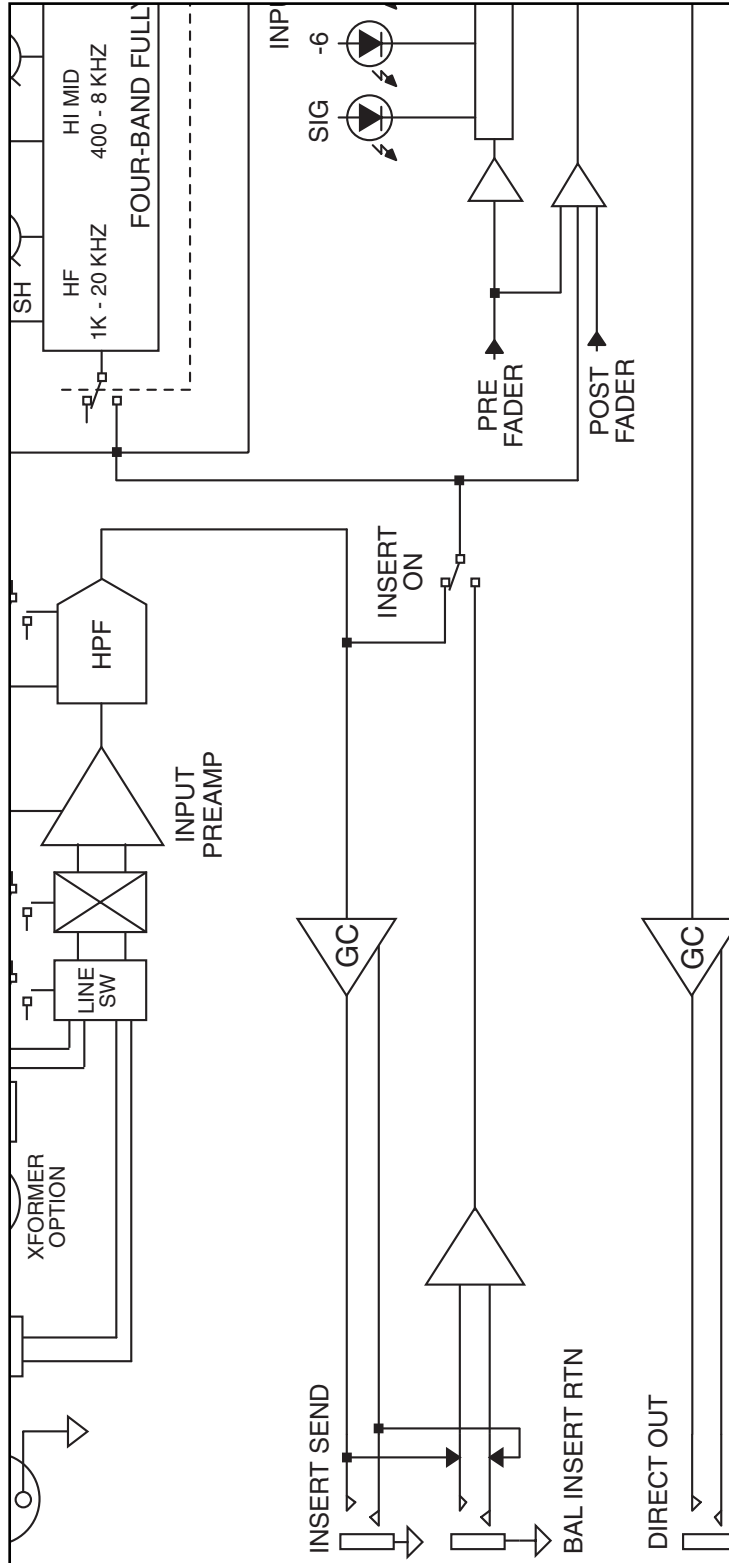

panel

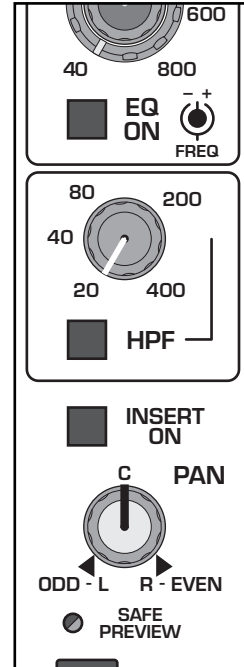



Insert features

Insert ON switch

The Insert point is located after the EQ and before the Low Pass Filter. External signal processors can be inserted into the channel via 1/4" TRS connectors (send and return) on the rear panel. The SEND signal is unbalanced and the RETURN can accept both unbalanced and balanced signals.

 Insert is switched OUT. Any signal coming into the Insert RETURN jack is left unused. The Insert SEND jack can be used to derive a post-EQ, pre-LPF output from the channel without interrupting the channel's normal signal flow.

 Insert is switched IN. The Insert RETURN jack is activated. The RETURN jack can also be used as an input for situations where the mic preamp and its associated features are not required, such as when using an external mic preamp.

 If you are using something like an external tube mic preamp, you can bypass the channel's input preamp by coming into the insert return jack.

pan control

 See description of Bus Assignment features later in this section

safe preview

 Safe Preview LED
See LOCAL MICROPROCESSOR CONTROL section

mute

 Mute switch
See LOCAL MICROPROCESSOR CONTROL section

write-in label

This label may be written on with a grease-marker, or dry-erase pen and later wiped clean. Masking tape may also be placed on this surface, if desired. If you write on it with a "Sharpie", you may have trouble getting the writing off. If this is the case, your best bet is to wipe the label off with isopropyl (rubbing) alcohol.

1 mono input module

module

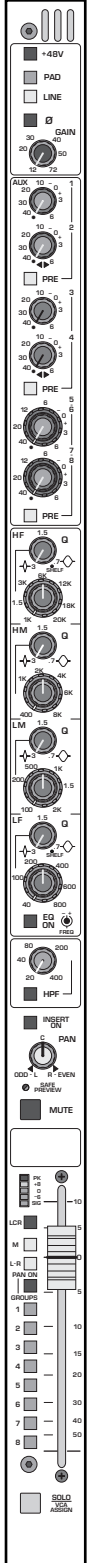

block diagram

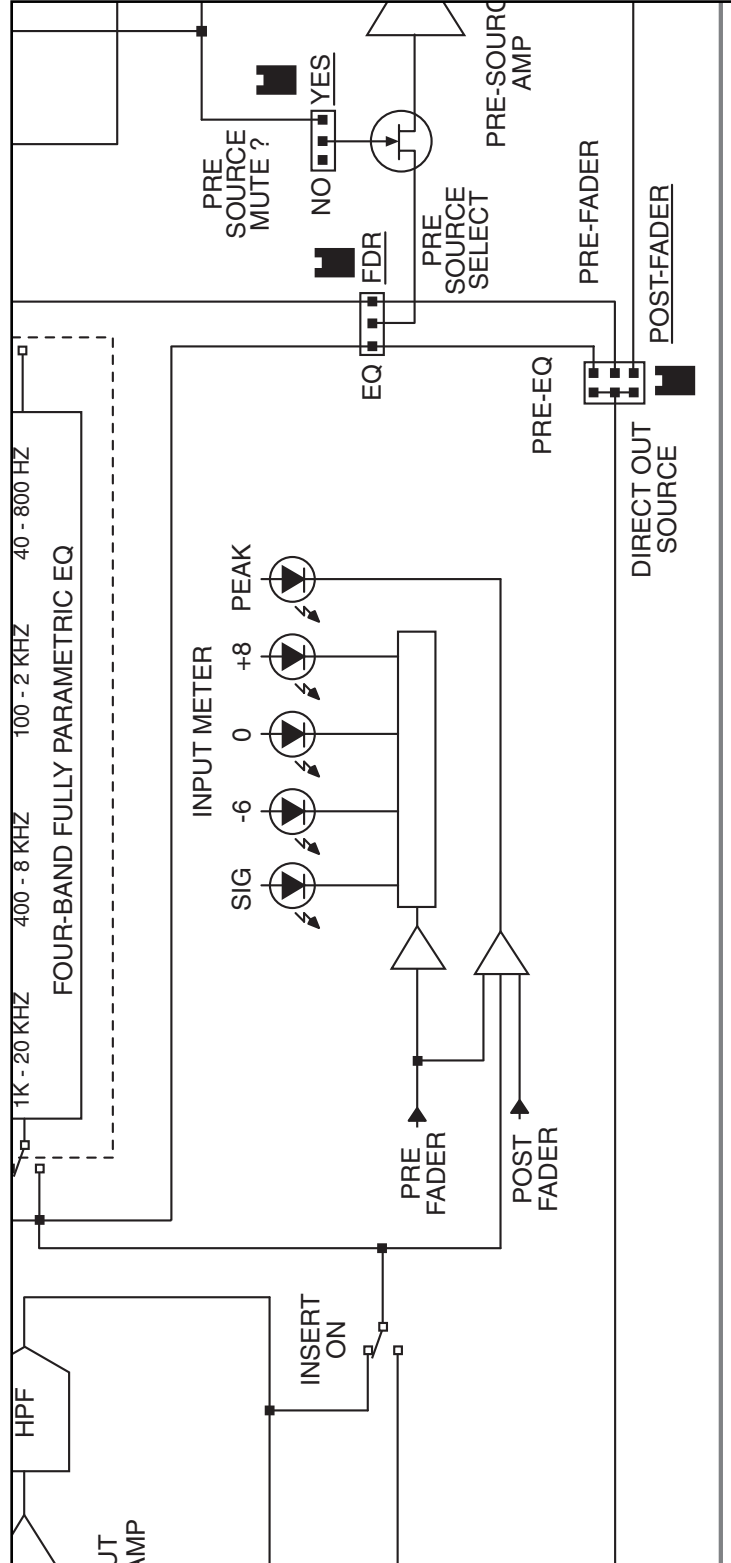

panel

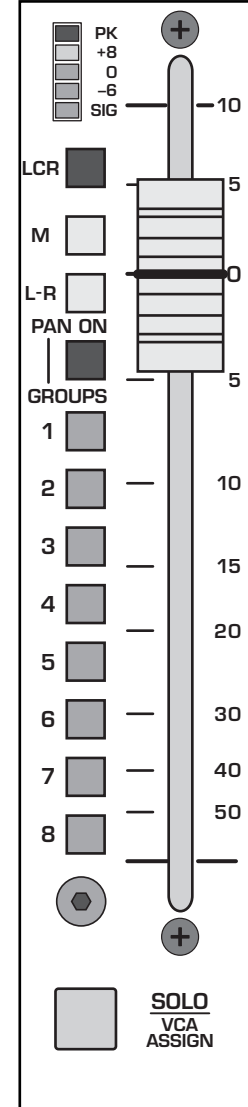

level meter features

level meter

 Each input includes a five-segment LED meter for visually monitoring signal levels. This is essential for setting up and maintaining proper gain structure.

peak indicator—PK

 The input signal is monitored at several points throughout the channel. These points are the mic preamp, the EQ stage and the fader stage. Overloads at any of these stages will cause the red peak-LED to light. Then the channel gain should be reduced.

signal level LED's

 These three LEDs light up at +8—yellow, 0—green, and -6 dB—green. This level range -6 to +8 is the optimum operating range. Compressed or relatively constant signals should remain close to 0.

signal present indicator—SIG

 This green-LED varies in brightness in response to signal levels between -40 dB and -6 dB.

Occasional flashing of the peak LED is acceptable, but frequent flashes indicate that channel levels must be lowered.



1 mono input module

module

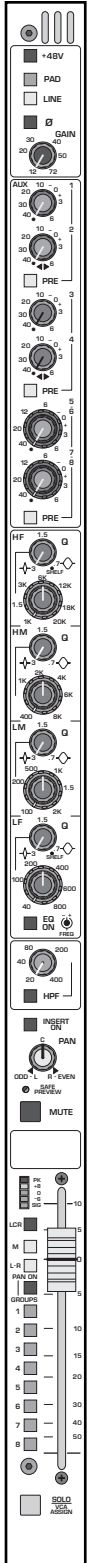

block diagram

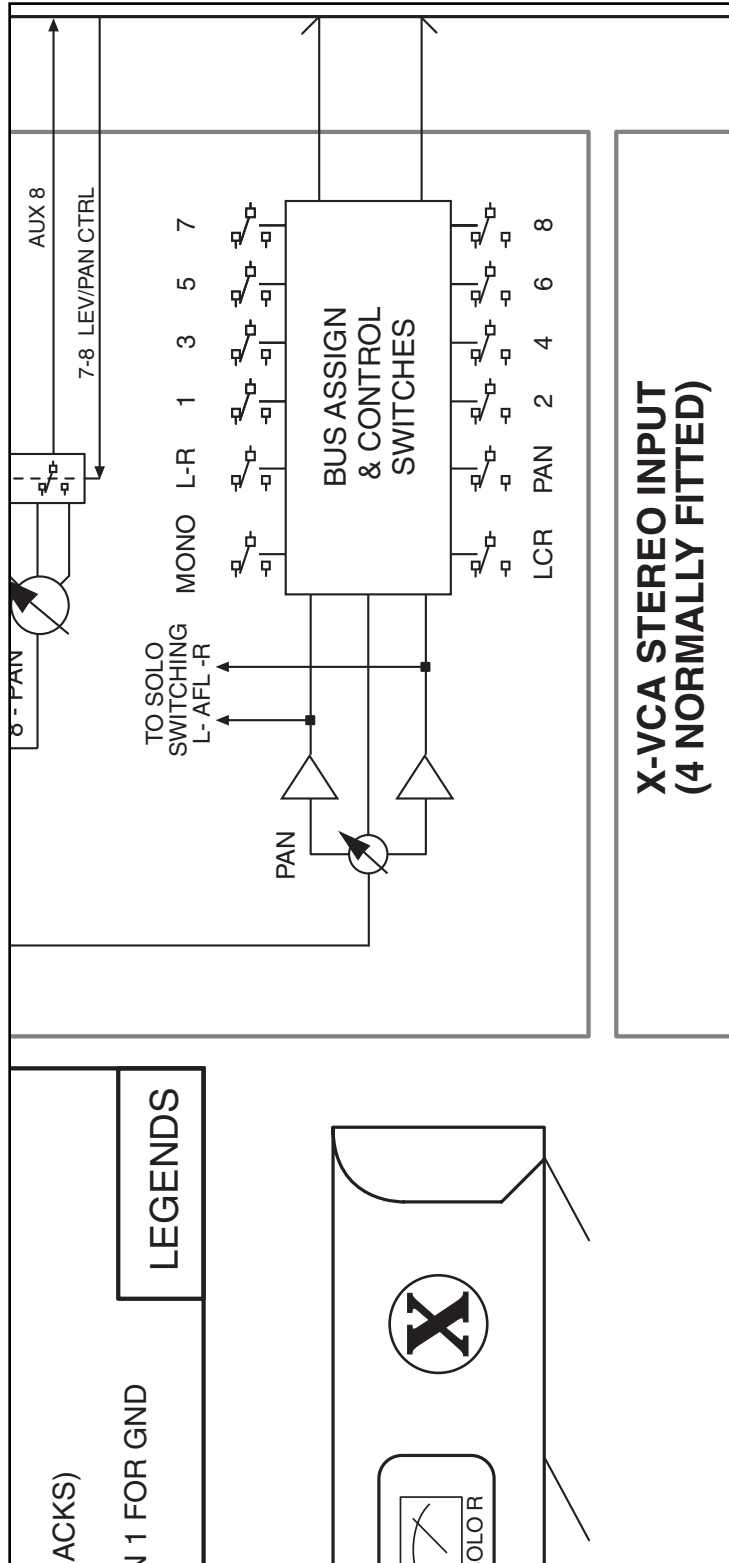

panel

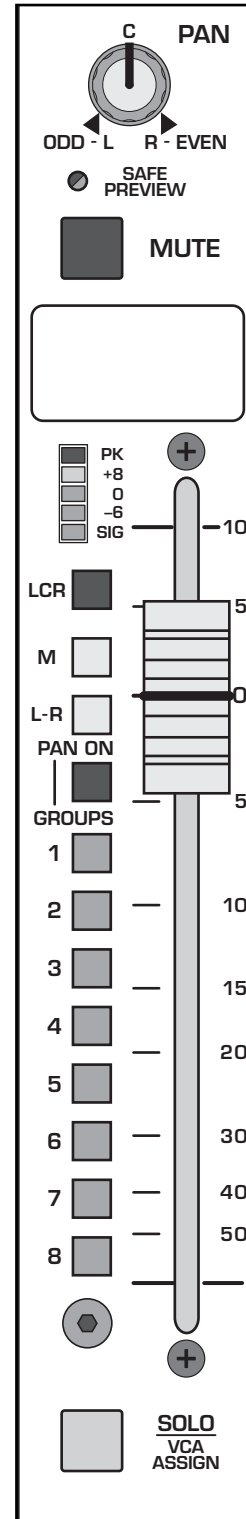

bus assignment features

The Input bus assignment section offers considerable flexibility for creating what eventually becomes the main output mix. Such features as LCR, GROUP PAN ON and eight-individual group assignments allow several approaches to building the desired mix. All assignments are derived post-fader, post-eq, and post-mute.

pan control

 The pan control positions the signal within the stereo left/right field, (or between left/center or center/right in LCR mode). The signal must be assigned to either LCR or the L-R bus for the pan control to have any affect.

If the channel's Left/Right signal goes way when the Pan pot is at center, check to see if the LCR button is down. 

left-center-right—LCR

This feature is used to precisely position a signal in a sound system with a center speaker cluster in addition to left and right clusters. The PAN control becomes an integral part of how the input-signal is sent to the LEFT, CENTER, and RIGHT outputs.

The post-fader signal is assigned to the LEFT, RIGHT, and MONO/CENTER buses. Relative amounts of the signal fed to each bus is determined by the position of the PAN control.

mono assignment—M

The signal is assigned to the discrete mono bus. When the LCR button is depressed, this switch is bypassed.

left / right assignment—L-R

The Input signal is assigned to the main Left and Right output buses, deriving its signal after the channels pan system. When the LCR button is depressed, this switch is bypassed.

pan on—groups—PAN ON

The eight GROUP assignment switches assign the input signal in mono, independent of the pan pot.

The eight GROUP assignment switches assign signals as four stereo-pairs. The PAN control governs the stereo placement of the four stereo-pairs, which are now configured as odd-left / even-right.

For example: GROUP 1—left, GROUP 2—right, GROUP 3—left, GROUP 4—right, ...continuing through GROUP 8.

group 1–8 assignment

The input channel's post-fader signal is assigned to the corresponding GROUP bus(es). see—pan on—groups

1 mono input module

module

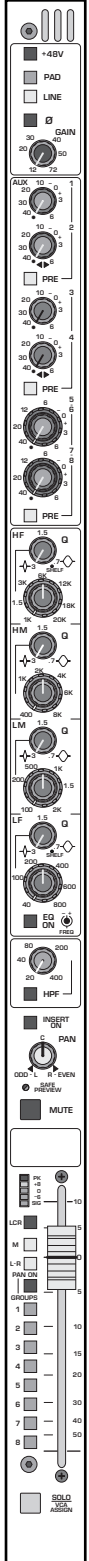

block diagram

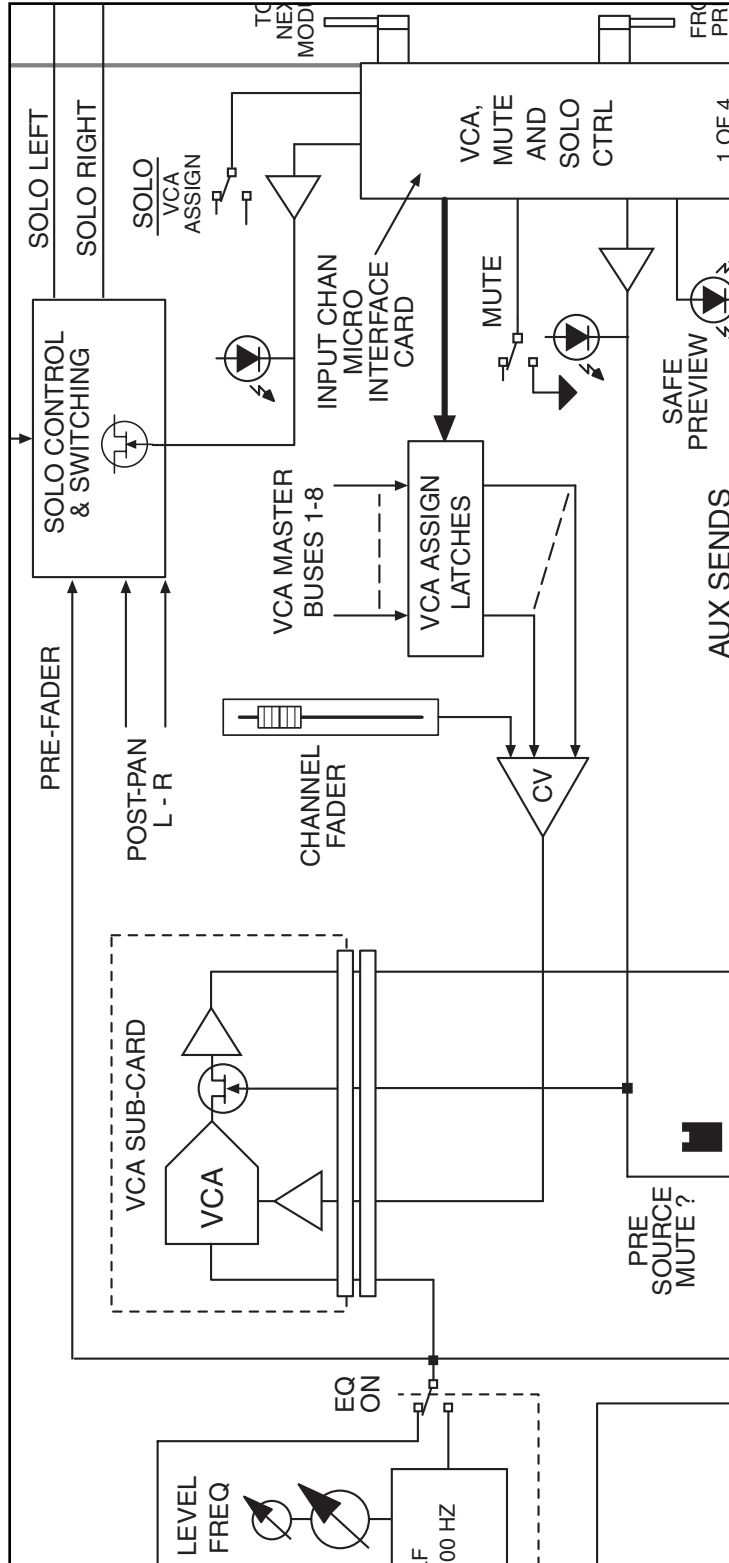

panel

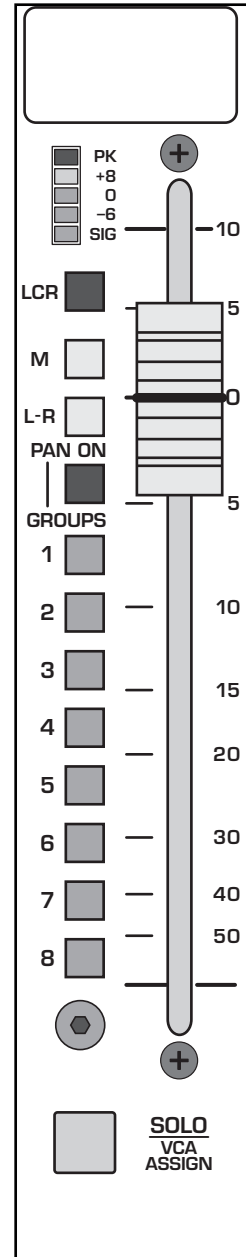

features

input fader

The input fader is the primary level control for signals being sent to any of the consoles mix buses. The signals affected are the AUX sends selected to be pre-fader. The fader offers greater than 80dB of attenuation and up to 10dB of boost. Normal operation is between -10 and 0.

The fader itself is a 100mm 10K linear taper slide potentiometer. It controls the voltage to the channel's VCA. No audio passes through the fader.

solo switch

 Pressing this momentary switch will include (illuminate) or exclude (not-illuminated) the channel from the consoles solo system.

See **SOLO /VCA Edit switch** section.

When VCA faders become dirty or worn, they do not become noisy because there's no audio going through them.



1 mono input module

block diagram

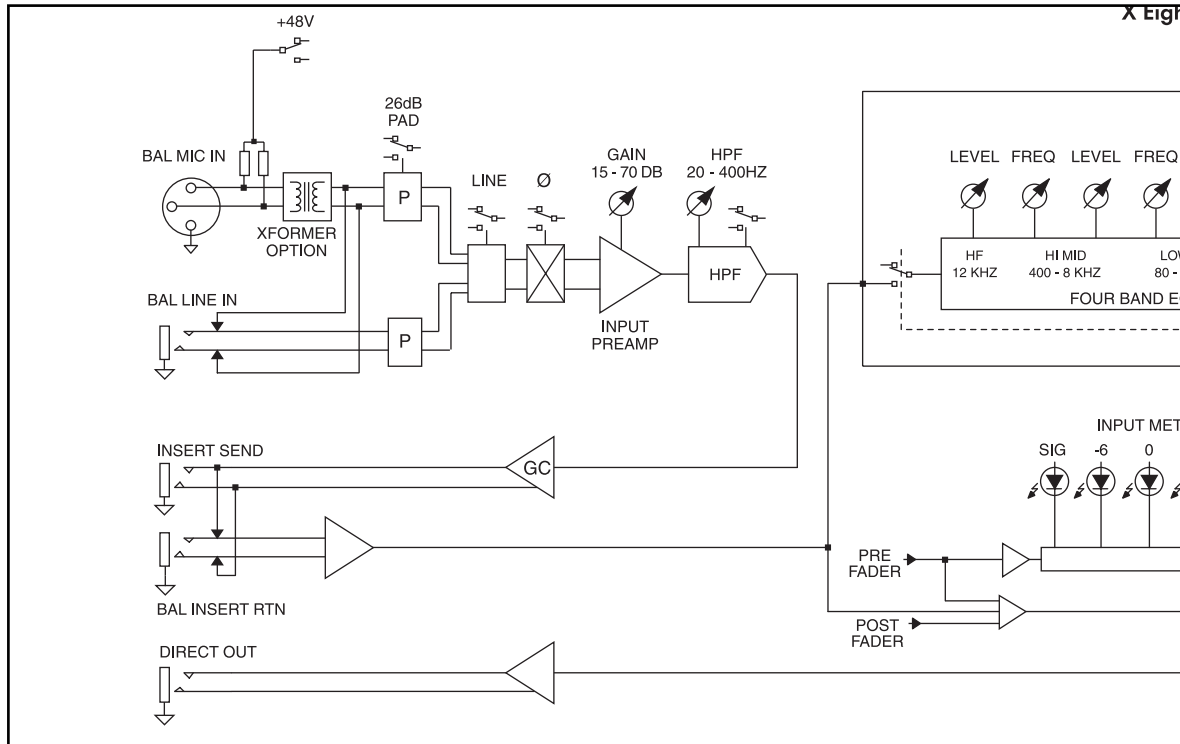

module rear

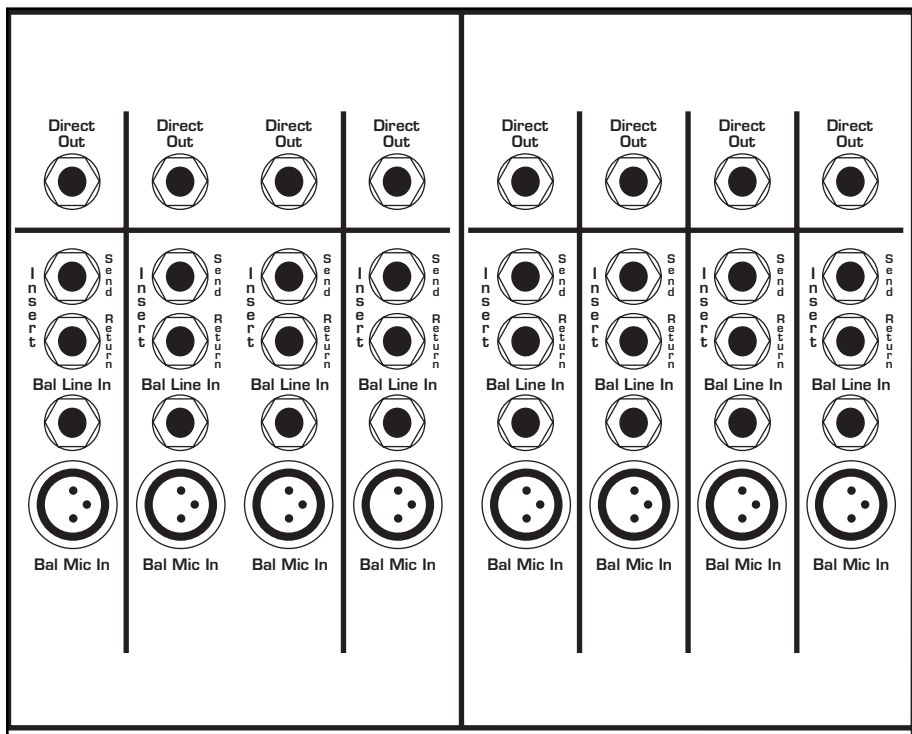

rear panel features

direct out 1/4" TRS jack

 The input channel's signal is available at this output jack. The default signal routing is derived post-fader, post-eq and post-mute. This output jack is ground-compensated.

insert points

Separate 1/4" TRS jacks provide the facilities for inserting an external signal processor into the signal path of the input channel.

insert send

 This jack serves as an output for connection to the input of a signal processor. The signal is derived after the mic preamp and HPF but before the eq section. Plugging a 1/4" TRS plug into this jack does not break the signal flow of the channel. This output jack is ground-compensated.

insert return

 The output of a signal processor is fed to this jack. It can accept a balanced or unbalanced signal and is located pre-eq. Plugging a 1/4" TRS plug into this jack breaks the signal flow of the channel.

balanced line-in jack—Bal Line In

 Line-level signals, balanced or unbalanced, may be brought into the input channel through this jack. The LINE switch must be depressed for this jack to be active.

balanced mic-in xlr connector—Bal Mic In

 This balanced female XLR accepts a low-impedance microphone signal, or a line-level signal, depending on position of the LINE switch on the front panel.

see—mono input module, phantom power, line

2 stereo input module

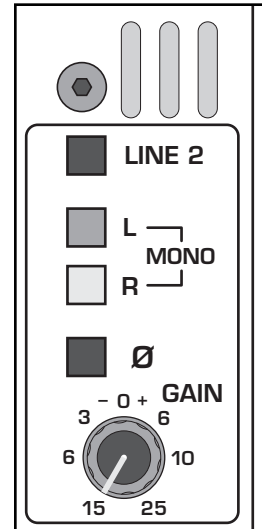

features

The Stereo Input Module can be configured to accept either a stereo pair of signals or a standard mono signal. Unlike the Mono Input module, the Stereo input modules do not have mic preamps and their associated features (48V phantom power and PAD). Instead, the Stereo Input module accepts line level signals via multiple pairs of input connectors - RCA, 1/4" TRS and Female XLR. When configured as a Stereo Module, the Left and Right signals are kept separate throughout the module. Settings in the EQ section apply equally to both L & R signals.

Input signal switching

There are six Input connectors on the back of the module - three stereo pairs. The primary pair of connectors are Female XLR. This Left / Right pair makes up "Balanced Line In 1". The secondary connectors are 1/4" balanced TRS and unbalanced RCA. These connectors make up "Line In 2". The TRS connectors override the RCA connectors.

Line select - Line 2 switch

The channel is in LINE 1 MODE. The signals are brought in via the left and right line-input XLRs located on the rear panel.

The channel is in LINE 2 MODE. The signals are brought in via the RCA line input connectors which are normalled through the 1/4" TRS line-input jacks. Insertion of a plug into the 1/4" jack disconnects its associate RCA jack.

left and right mono-switches

These switches provide several options for configuring the stereo line-input module as a mono line-input module.

left right

Signals brought into the left and right inputs are treated as stereo throughout the module.

left right

Signals brought into the left and right inputs are summed together immediately before the GAIN control. The summed signal is treated as mono throughout the rest of the module.

left right

The signal fed to the left input is treated as a mono signal throughout the module. No signal from the right input is used.

left right

The signal fed to the right input is treated as a mono signal throughout the module. No signal from the left input is used.

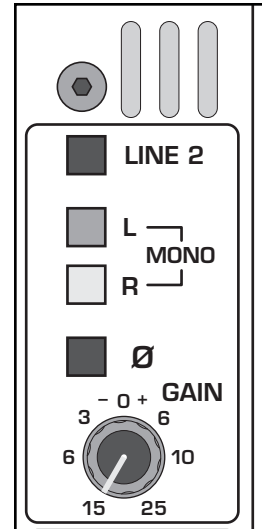

2 stereo input module



features

polarity reverse— \emptyset

This switch inverts the polarity of the right input signal in relation to the left input signal. see—mono input module for more info on polarity reverse

-  Polarity of the right input signal is inverted.
-  Polarity of the right input signal is not inverted.

input gain—GAIN

 This control adjust the gain of the input preamp(s). Both left and right input signals are affected by this control.

2 stereo input module

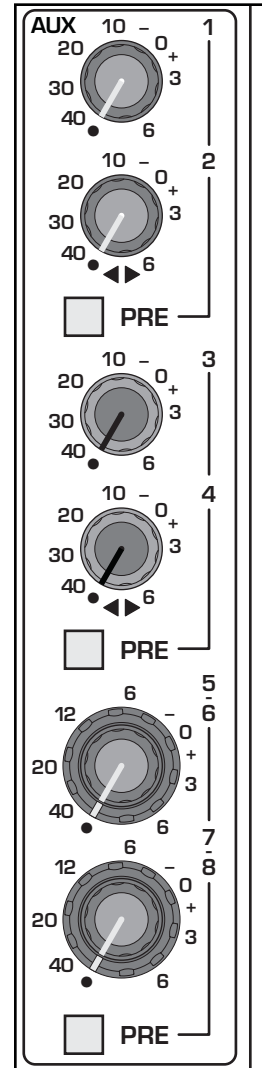

aux send features

Refer to the Mono Input Module for basic information on the Aux sends. What's covered here is information that is specific to the Stereo Input module.

As we already covered on the Mono Input module, each of the odd/even pairs can be globally configured to operate as level / level (for normal mono operation) or level / pan (for stereo operation). The global configuring is done in the Aux masters which are located on the Group modules.

Stereo - Being that this module accepts stereo signals, the level / pan, or stereo mode is true stereo. This means that when you 1) bring a stereo pair of signals into the module, and 2) globally assign a pair of auxes for stereo operation, your left signal will go onto the odd bus and the right signal will go onto the even bus. In this mode, the odd numbered pot is your "balance" control and the even numbered pot is your "level" control. This is ideal for routing stereo feeds such as effects returns and two-track playback onto the auxes.

Mono - When a pair of auxes is not globally assigned for "level pan" operation (standard level / level), the incoming stereo signal is summed to mono before it gets to the pair of aux sends.

If a Stereo Input module is configured as a Mono Input via the Left and Right - Mono switches, the auxes function just as they do on a Mono Input module. See Mono Input module for more information.

Eight auxiliary sends are available for creating individual output mixes. These can be used to drive effects processors, provide monitor mixes, or create broadcast or alternate sound reinforcement mixes, or other special requirements. Each pair may be selected from within the master section for mono or stereo operation.

aux sends 1-2, 3-4, 5-6, 7-8

☉ See explanation of Aux sends - Stereo & Mono (above). All four pairs of Aux sends function the same way. Like the Mono Input module, Auxes 1/2 and 3/4 are configured as individual pots and Auxes 5/6 and 7/8 are configured as dual concentric pots.

Aux 1/2, 3/4 and 5-8 PRE switches

- AUX SENDS are post-insert, post-eq, post-mute, post-fader
- AUX SENDS are post-insert, post-eq, post-mute, pre-fader

2 stereo input module

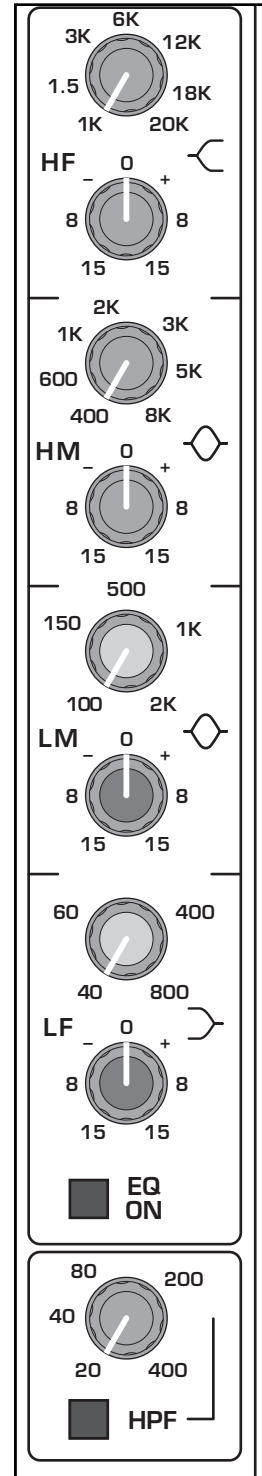

EQ features

The X-VCA Stereo Input module offers four bands of EQ - High, High mid, Low mid and Low. The High and Low are shelving type EQ and the High mid and Low mid have a fixed (non-adjustable) Q of 1. Although the left and right signals are processed separately, the parameters are set in tandem by common front panel controls.

high frequency—HF

 Frequency Continuously sweepable between 1kHz and 20kHz

 Boost / Cut 15dB boost and cut.

high mid—HM

 Frequency Continuously sweepable between 400 Hz and 8 kHz.

 Boost / Cut 15dB boost and cut.

Low mid—LM

 Frequency Continuously sweepable between 100 Hz and 2 kHz.

 Boost / Cut 15dB boost and cut.

Low frequency—LF

 Frequency Continuously sweepable between 40 Hz and 800Hz.

 Boost / Cut 15dB boost and cut.

eq on

 Equalizer is on. This switch is used to activate the EQ section and can be used to make A/B comparisons between "flat" and eq'd signals.

high-pass filter—HPF

Proper use of the high-pass filter reduces or eliminates unwanted low frequencies without substantially affecting the program material. Quite often such unwanted low frequencies are included with in-coming mic- or line-input signals. For example, stage rumble or wind can be picked up through vocal mics. The slope of the high-pass filter is 12dB per octave.

HPF—High pass filter

 When the high-pass filter is on, this control selects a frequency between 20Hz and 400Hz as the point where attenuation begins.

 High-pass filter is on.

2 stereo input module

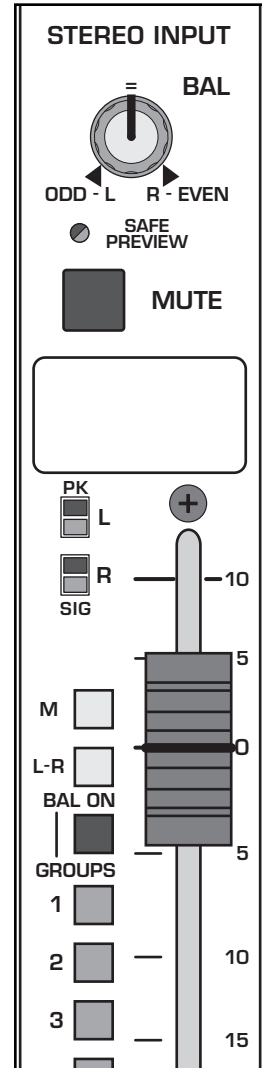

metering features

Balance control

 See description of Bus Assignment features later in this section

safe preview

 Safe Preview LED
See LOCAL MICROPROCESSOR CONTROL section

mute

 Mute switch
See LOCAL MICROPROCESSOR CONTROL section

write-in label

This label may be written on with a grease-marker, or dry-erase pen and later wiped clean. Masking tape may also be placed on this surface, if desired. If you write on it with a "Sharpie", you may have trouble getting the writing off. If this is the case, your best bet is to wipe the label off with isopropyl (rubbing) alcohol.

Left and Right signal LED indicators

Both Left and Right inputs each have their own Peak and Signal present LED's.

peak indicator - PK

 The input signal is monitored at the mic preamp, the EQ stage and the fader stage. Overloads at any of these stages will cause the red peak-LED to light.

signal present indicator—SIG

 This green-LED varies in brightness in response to signal levels between -40 dB and -6 dB.

2 stereo input module

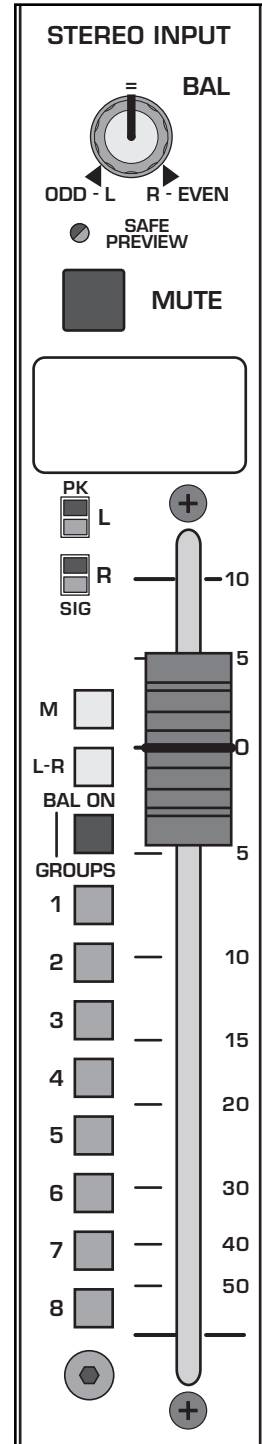



Bus assignment features

Balance control

 The Balance control adjusts the Stereo balance for the Left/Right assignment and Group assignment sections when the BAL ON button is depressed

balance on—groups—BAL ON

 The left and right signals are summed as mono before being routed to the L-R and Group assignments.

 The left and right signals are routed to L-R and Group assignment section in odd/even pairs. GROUP assignment switches 1, 3, 5 and 7 carry the left input-signal and GROUP assignment switches 2, 4, 6 and 8 carry the right input-signal. The proportion of left vs. right can be adjusted by the BALANCE control.

group 1–8 assignment

 The input channel's post-fader signal is assigned to the corresponding GROUP bus(es). see—balance on—groups

input fader

The input fader is the primary level control for signals being sent to any of the consoles mix buses. The only signals not affected are AUX sends selected to be pre-fader. The fader offers greater than 80db of attenuation and up to 10db of boost. Normal operation is between -10 and 0.

solo

 Pressing this switch will include (illuminated) or exclude (not-illuminated) the input channel from the consoles SOLO system. The channel is Solo'd in stereo. see—master module, solo control system

2 stereo input module

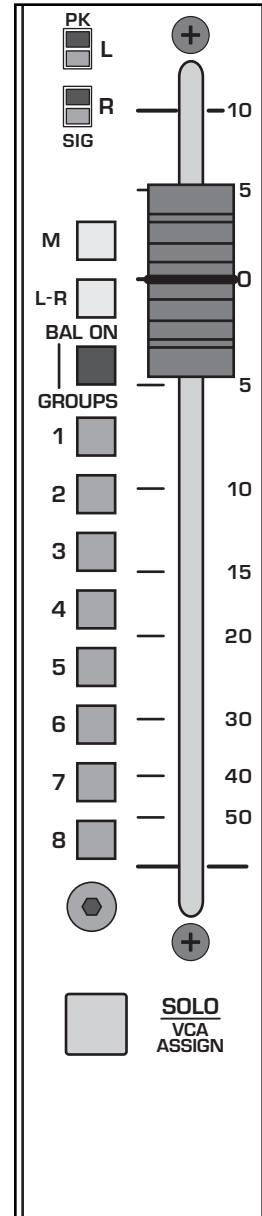

features

input fader

The input fader is the primary level control for signals being sent to any of the consoles mix buses. The signals affected are the AUX sends selected to be pre-fader. The fader offers greater than 80dB of attenuation and up to 10dB of boost. Normal operation is between -10 and 0. The fader itself is a 100mm 10K linear taper slide potentiometer. It controls the voltage to the channel's VCA. No audio passes through the fader.

solo switch

 Pressing this momentary switch will include (illuminate) or exclude (not-illuminated) the channel from the consoles solo system. See **SOLO FEATURES** section.

2 stereo input module

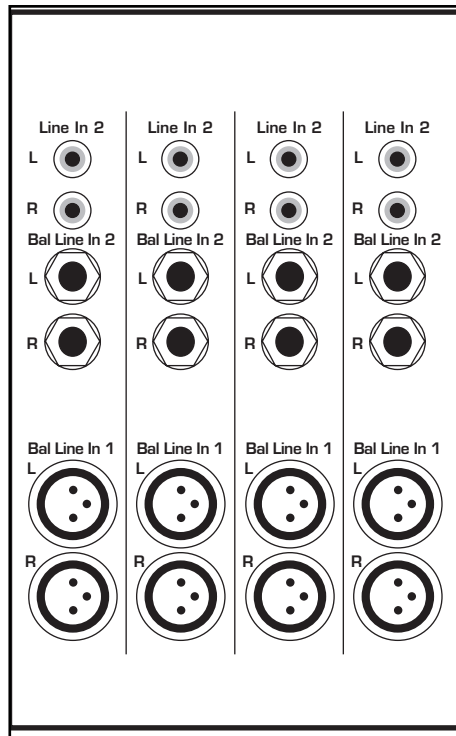

rear panel features

The stereo line-input module provides connectors for three stereo line-level signals. see—line 2 switch.

balanced left and right line-in XLR connectors



These two jacks accept balanced or unbalanced +4dB line level signals. The LINE 2 switch on front-panel must be disengaged for these connectors to be active.

line-input left and right 1/4" TRS jacks



These two jacks accept balanced or unbalanced line level signals. The LINE 2 switch on front panel must be engaged for these jacks to be active.

line-input left and right RCA connectors

These two jacks accept unbalanced line-level signals. They are active when the LINE 2 switch on front-panel is engaged and nothing is plugged into the corresponding left or right 1/4" TRS jack(s).

3 group module

module

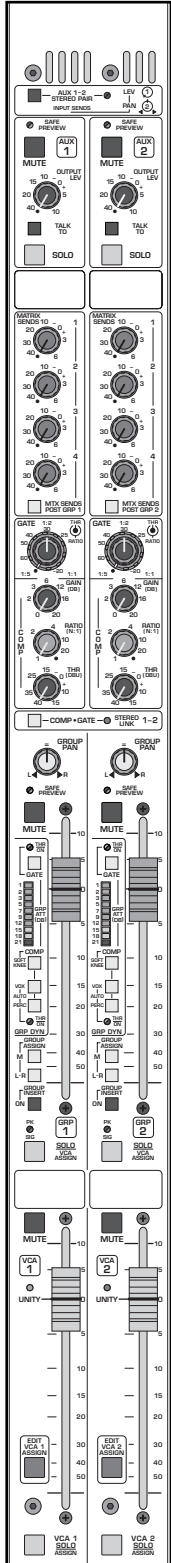

block diagram

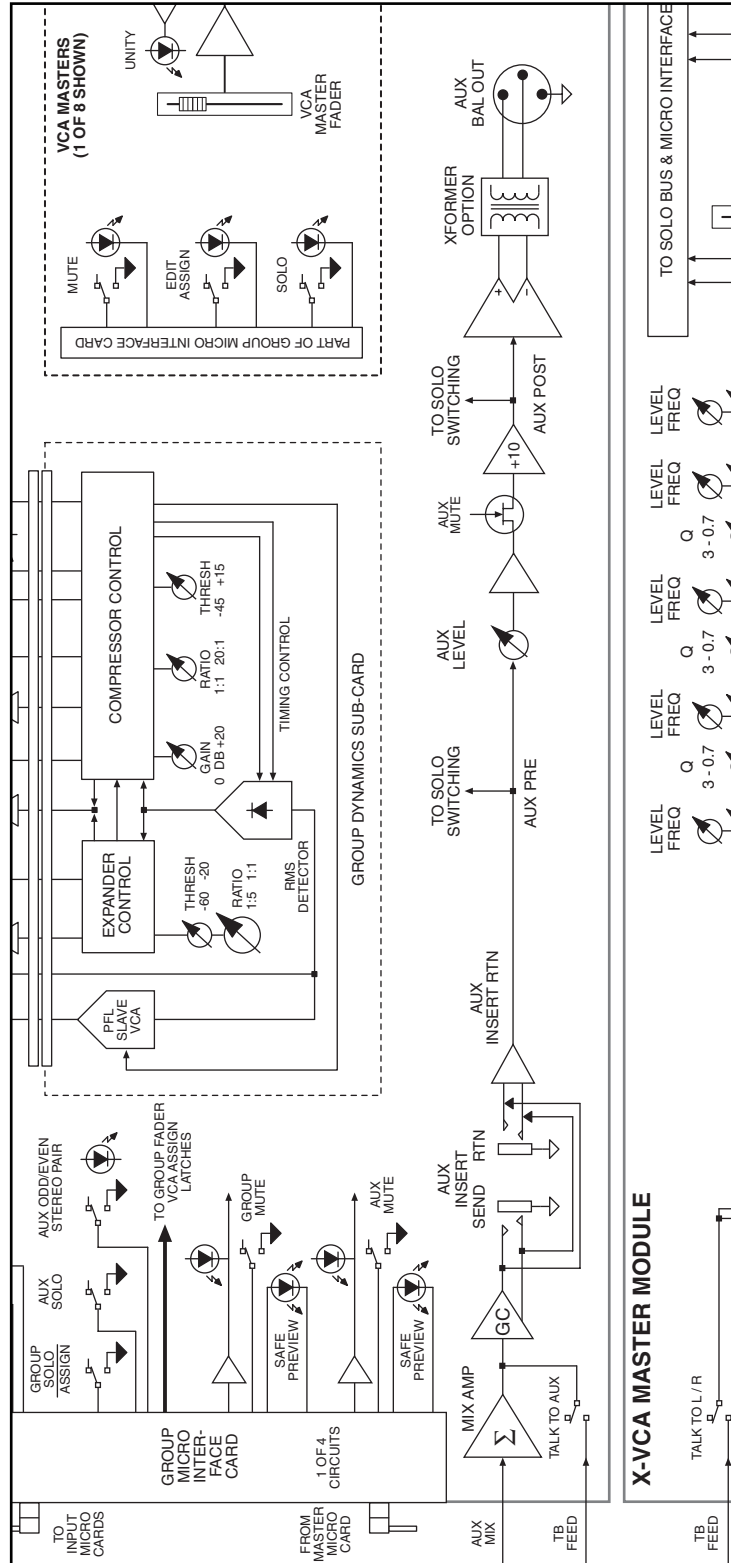

panel

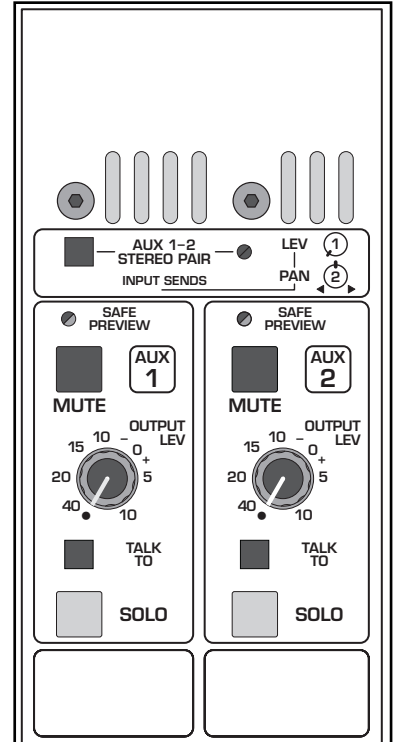

group module features

The Group modules are physically configured in pairs, four pairs making up the eight Groups. Each of the eight Group modules offer identical functions for the eight associated Aux Masters, Audio Groups, and VCA Groups. Each group module includes the following sections:

- *Aux output control
- *Matrix send
- *Groups dynamics control with gain reduction meter
- *Audio group with 100mm fader and VCA control
- *VCA master group with 100mm fader

aux output control

AUX STEREO PAIR switch Each odd / even pair of Aux masters has an Aux Stereo Pair switch for globally configuring the associated auxes for Level / Level or Level / Pan operation

The associated odd / even pair of Auxes function as individual, discrete mono aux sends.

The associated odd / even pair of Auxes function as a stereo pair. The odd numbered Aux acts as a Level control for the stereo pair and the even numbered Aux acts as a pan control

mute



Mute switch

See LOCAL MICROPROCESSOR CONTROL section

Aux master output level (1 - 8)



The AUX MASTER output level controls set the levels that appear at the corresponding AUX output connectors on the rear-panel.

Talk to (1 - 8)

Adds the TALKBACK system output to the associated AUX output. The level of the TALKBACK signal is set by the TALKBACK level control in the MASTER section.

solo switch

Pressing this momentary switch will include (illuminate) or exclude (not-illuminated) the channel from the consoles solo system.

See SOLO FEATURES section.

write-in label

This label may be written on with a grease-marker, or dry-erase pen and later wiped clean. Masking tape may also be placed on this surface, if desired. If you write on it with a "Sharpie", you may have trouble getting the writing off. If this is the case, your best bet is to wipe the label off with isopropyl (rubbing) alcohol.

3 group module

module

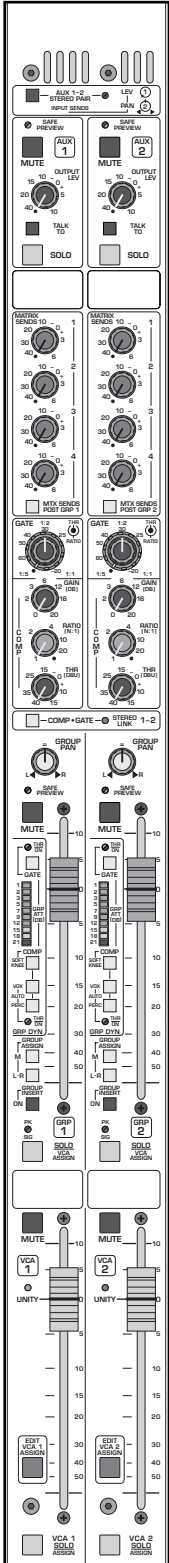

block diagram

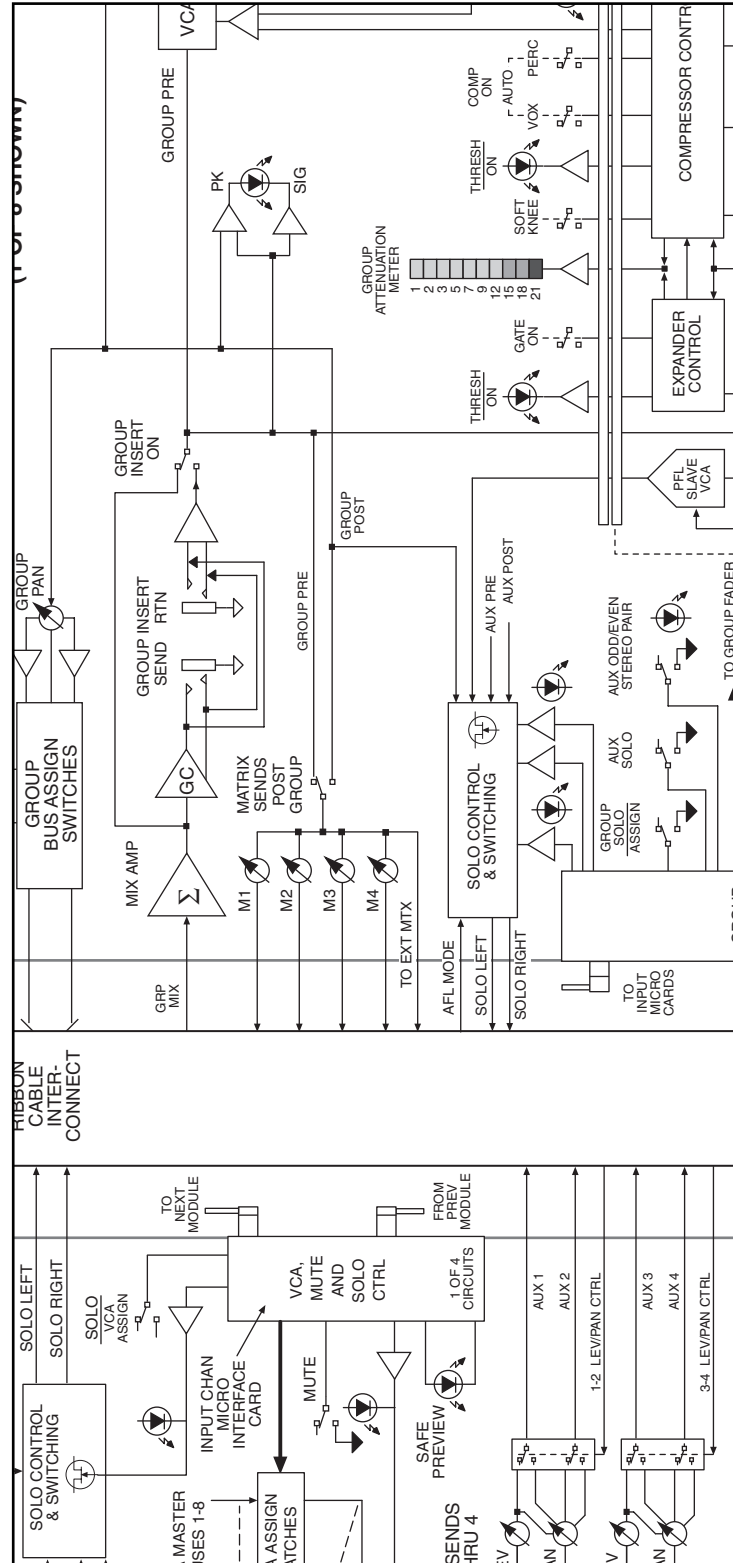

panel

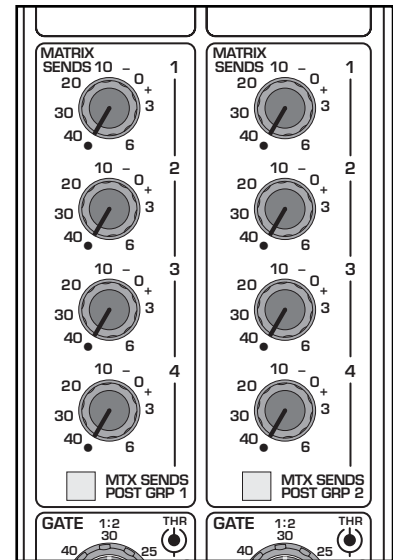

matrix sends

The X-VCA includes four MATRIX outputs. Each of these outputs can be made up of signals from the eight GROUPS; the left, right and mono buses; and an external source. See Master section for more information. For expanded Matrixing capabilities, a 37 pin d-sub connector is included on the rear panel which contains all or the primary outputs. See Group module rear panel description for more information.

matrix 1-4 levels—M1, M2, M3, M4

 These level controls are used to mix the group's signal into the corresponding matrix.

post-group

The GROUP fader setting has no effect on the group-to-matrix level controls 1-4.

The GROUP fader is introduced into the signal path and will control the signal level. When the group is muted, the group's signals to matrix 1-4 are muted as well.

group module

X-VCA owner's manual

module

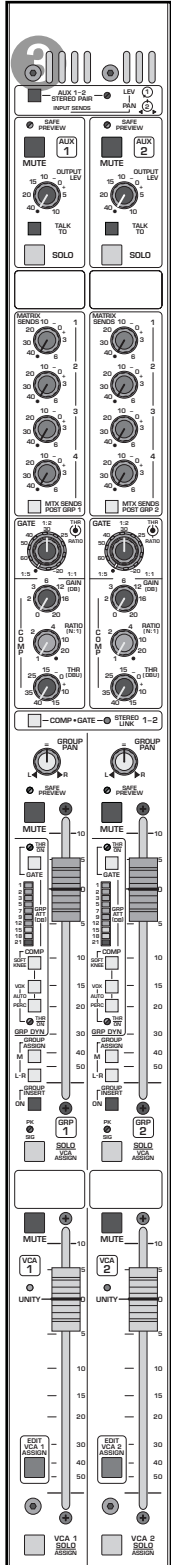

block diagram

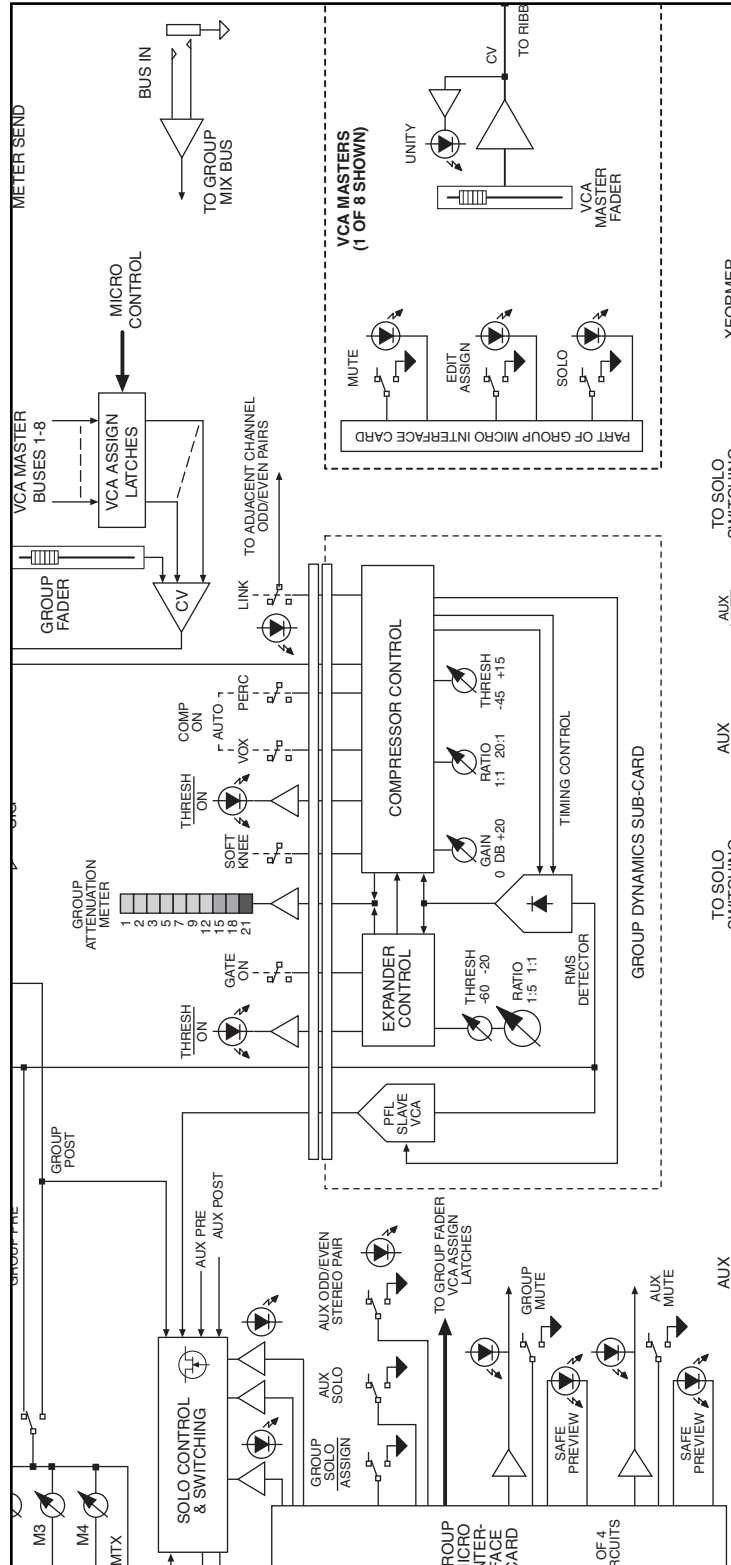

panel

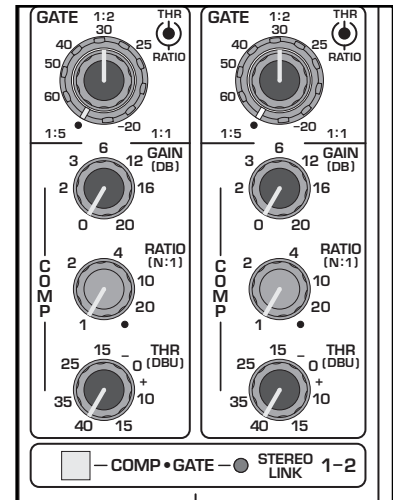

group dynamics section

The X-VCA Audio Group and Master modules include a number of features for flexible dynamic control of signal levels. On Group modules, the compressor and gate functions may be engaged separately or simultaneously. For a comprehensive discussion of these features, see Section on Dynamics Control Operation.

gate

The gate is used to attenuate or silence the signal when it's level falls below a selected point (threshold).

THRESHOLD (THR) control (center knob of dual concentric control)

 Adjusts the point at which any DECREASE in input signal level will cause a further reduction in output level (gain) as determined by the ratio control setting. Threshold may be set between -20db and -60db (and below).

RATIO control (outside of dual concentric control)

 Adjusts the proportion of output signal in relation to input signal when operating BELOW the set gate threshold level. Ratio may be adjusted from 1:1 to above 1:5. Gating demonstrates "soft knee" characteristics.

compressor

The compressor is used to reduce a signals dynamic range by the selected ratio. It can also be configured to limit the signals output level.

GAIN (make up) control

 Adjusts to make up for apparent gain loss due to compression of input signals. In the Solo Pre position (default), the output of the dynamics section can be viewed before the VCA control system fader. The gain control should be adjusted to show near 0 reference level when normal signals are present. The GAIN control has a range of 0db to +20db.

RATIO control

 Adjusts the proportion of output signal in relation to input signal above the set threshold level. The ratio of input to output signal may be adjusted from 1:1 to greater than 20:1 (hard limiting).

THRESHOLD (THR) control

 Adjusts point at which any increase in input signal to the compressor/limiter section will cause a reduction in output level at a rate determined by the ratio control setting. The threshold may be set between -45db and +15db.

COMP-GATE stereo link

 Links the odd and even GROUP's dynamics sections for stereo operation. The GROUP with the highest amount of auto-attenuation controls the dynamics sections for both groups in the odd/even pair.

NOTE: This dynamics section is intended for use by an experienced operator. It's best to be familiar with compressors and limiters before using them in critical applications!



module

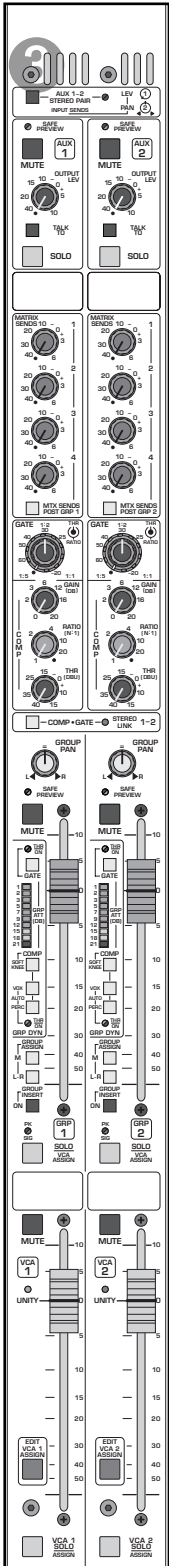

block diagram

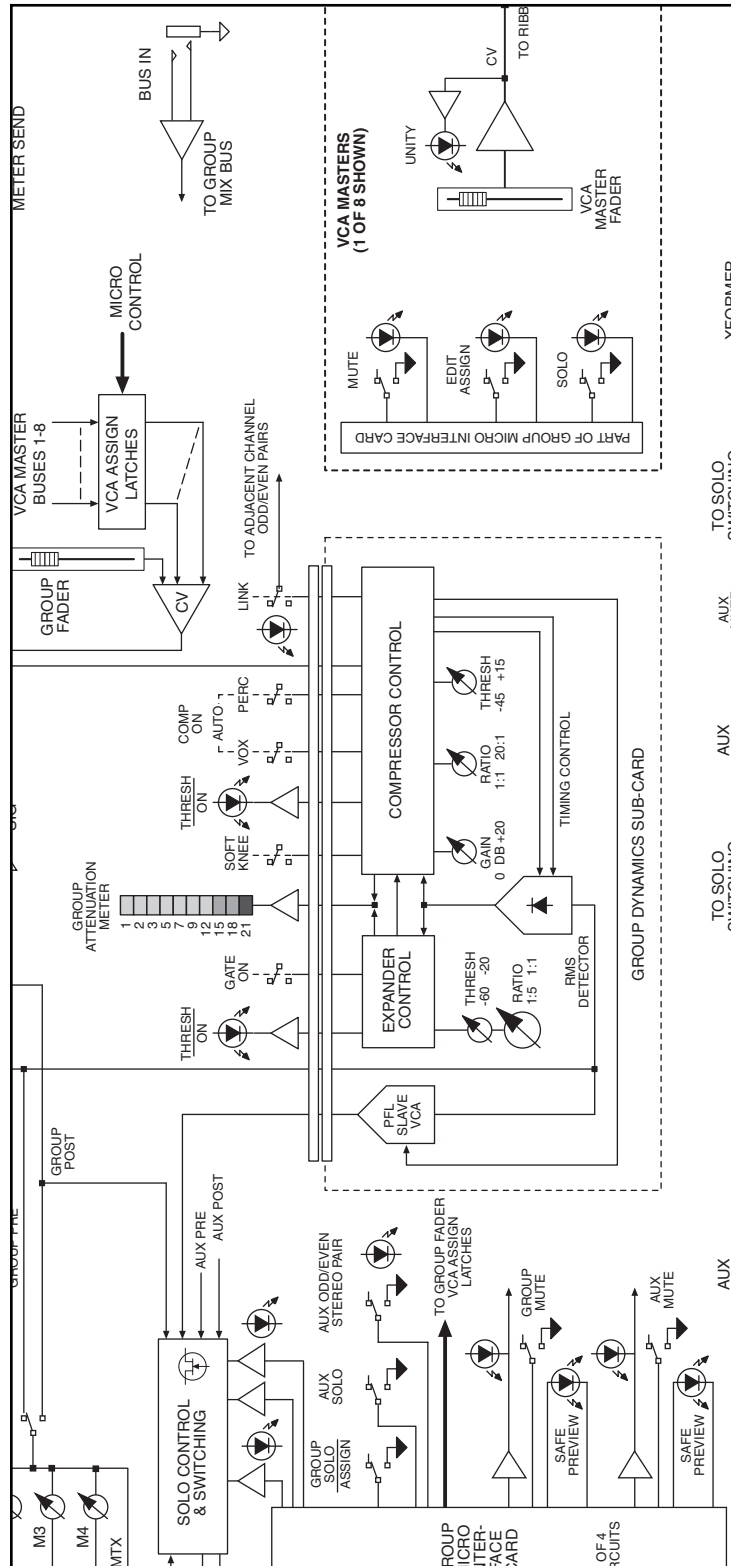

panel

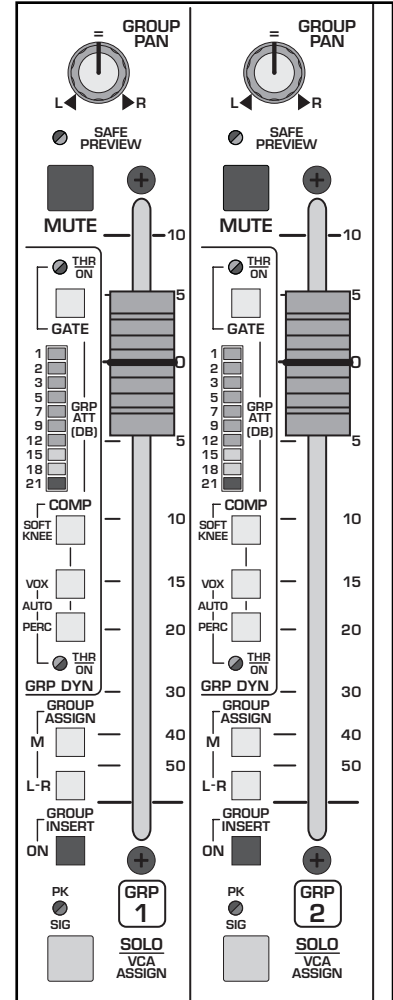

group dynamics section

Note: The following dynamics controls are located adjacent to the Group fader.

gate ON (downward expander)

 Activates the gate (downward expander) function.

gate ON/THR (Threshold) dual color LED

 Illuminates GREEN when the gate system is active. Illuminates RED when the group's signal level reaches the threshold level set by the GATE THR control. Note that red threshold indication is functioning at all times, even when gate is not active (switched off).

gain reduction meter (ATT)

 This ten-segment meter indicates the overall gain reduction applied to input signals by the dynamics system by either the gate function or the compressor function. If both gate and compressor functions are switched on, one of the two bi-color LEDs (gate ON/THR or comp ON/THR) will illuminate red to show which function is at threshold and causing the gain reduction.

comp SOFT KNEE Switch - Changes initial compression characteristic between Hard and Soft Knee.

 Hard Compression - Immediately reduces compressor output signal levels at the set compression ratio as soon as compressor input signal reaches the set threshold.

 Soft Compression - At threshold, reduces output signal level at a variable compression ratio over an increasing input signal level until the set compression ratio is achieved.



comp VOX on Switch

 Activates the compressor/limiter system. Attack and release times are optimized for vocal applications.

comp PERC on Switch

 Activates the compressor/limiter system. Attack and release times are optimized for percussion applications.

comp AUTO on (both VOX and PERC switches depressed)

  When both the VOX and PERC switches are depressed, the compressor/limiter system is activated with automatic control of attack and release times as determined by signal characteristics.

comp ON/THR (Threshold) dual color LED

 Illuminates GREEN when the compressor system is activated by either the VOX or PERC switch, or both. Illuminates RED when the channel's signal level reaches the threshold set on the COMP THR (threshold) control.

module

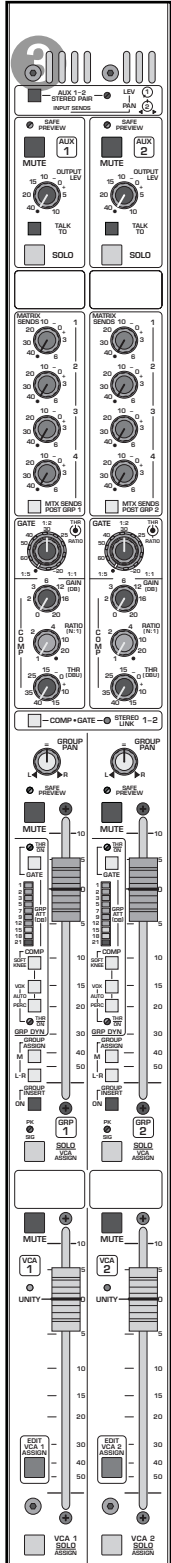

block diagram

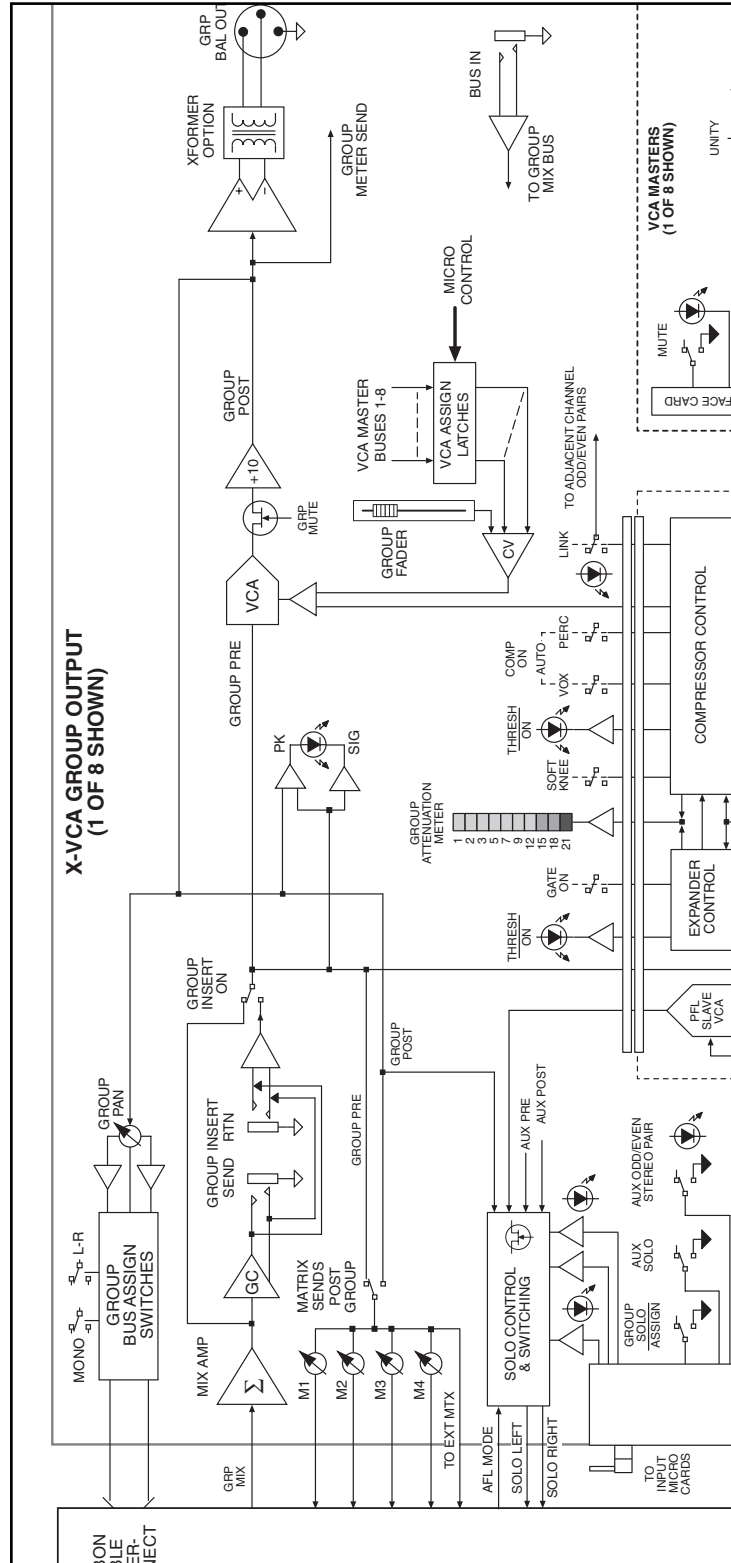

panel

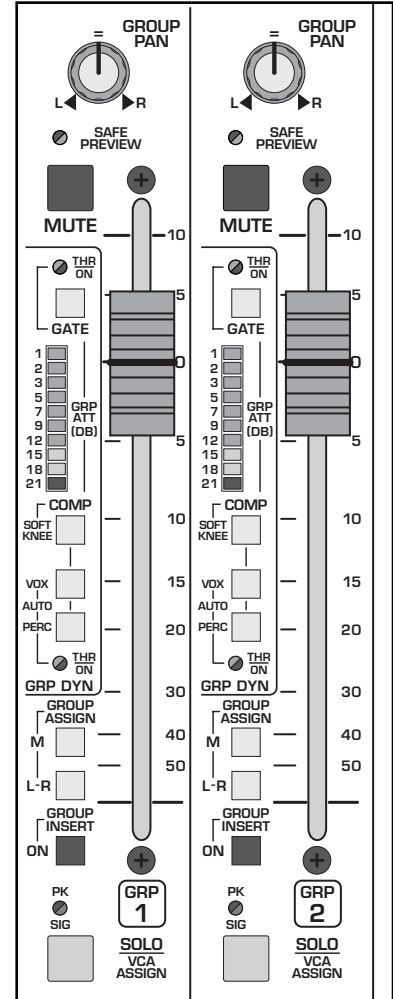

audio group control features

This section provides standard features for the Group bus masters. Signals that are assigned to the Audio groups are summed together to make up the audio Groups. A full featured dynamics control section (see previous section) can be engaged for processing the summed group signals. These signals can be assigned to the Left, Right and Mono buses and appear at the Group output jacks on the rear panel.

group pan

 The PAN pot is used to position the group signal within the stereo left / right field. The signal must be assigned to left and right in order for the PAN control to have any effect.

safe preview

 Safe Preview LED
See LOCAL MICROPROCESSOR CONTROL section

mute

 Mute switch
See LOCAL MICROPROCESSOR CONTROL section

audio group fader

This 100mm fader controls signal levels to the associated audio group outputs as well as signals assigned to the left/right and mono (center) mix buses.

mono assignment switch

 Post fader assignment of signal to the mono mix bus.

L-R stereo assignment switch

 Post fader/post pan pot assignment of signal to the left and right stereo mix buses.

Group insert ON switch

The Insert point is located after the group summing amp and before the dynamics control system. External signal processors can be inserted into the group via 1/4" TRS connectors (send and return) on the rear panel. The SEND signal is unbalanced and the RETURN can accept both unbalanced and balanced signals.

 Insert is switched OUT. Any signal coming into the Insert RETURN jack is ignored. The Insert SEND jack can be used to derive a pre dynamics, pre fader output from the group without interrupting the group's normal signal flow.

 Insert is switched IN. The Insert RETURN jack is active. A signal processor patched to the groups insert is switched into the signal path.

signal/peak LED

 This dual color LED responds audio Group's signal level. It illuminates green with varying brightness in proportion to the pre-fader audio signal. When the signal approaches clipping, either pre or post fader, the LED illuminates red.

solo switch

 Pressing this momentary switch will include (illuminate) or exclude (not-illuminated) the channel from the consoles solo system.
See SOLO FEATURES section.

module

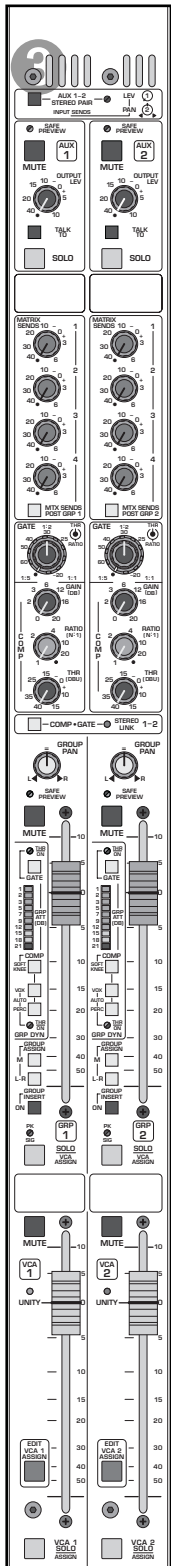

block diagram

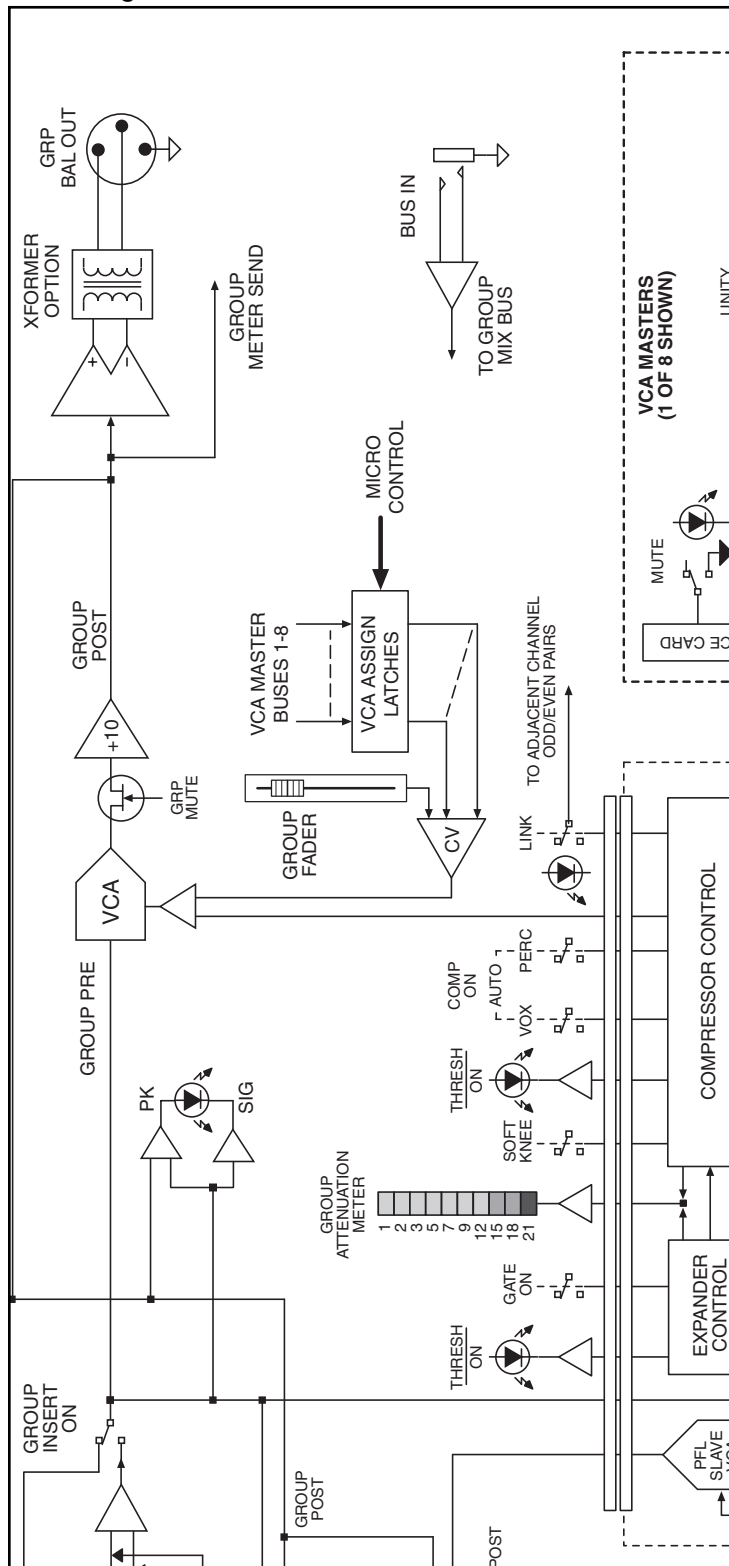

panel

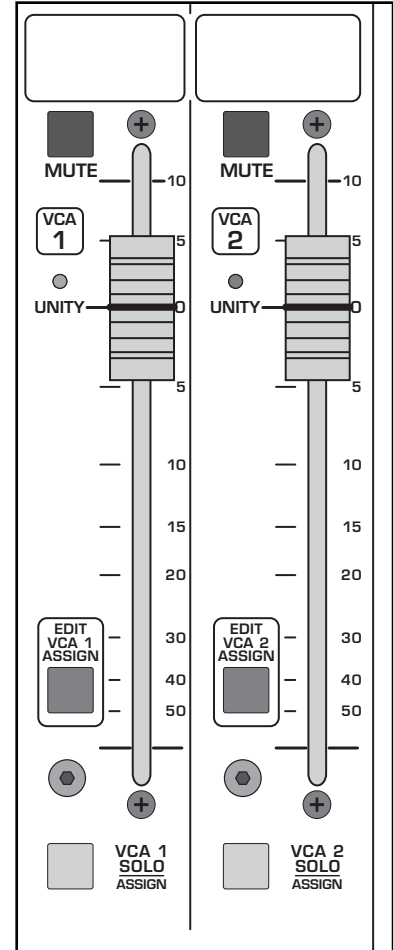

VCA group master control features

This section controls VCA levels of any assigned input channels or audio groups assigned to the VCA group. VCA control of audio groups is a unique feature not offered on most other VCA consoles. For more information on using VCA control of audio groups, see Section on VCA Group Operation.

 Caution: When assigning (or un-assigning) active channels during a live performance, care should be exercised as a level change will occur at any fader position other than UNITY.

vca group Channel MUTE switch

 This mute switch follows the assignment of the channels VCA system. When activated, it mutes all assigned input and audio group channels except when channel or group safe mode is activated. All primary and auxiliary outputs will be muted, including pre fader aux sends if internal mute jumper is in default pre fader mute YES position.

100mm VCA control fader

Controls relative volume levels of all input and audio group channels assigned to the VCA group. (No audio passes through this fader.)

unity LED indicator

 Illuminates when the fader is at its unity gain position. At unity gain, input or audio group channels may be assigned (or removed from assignment) without a level change.

VCA Group edit switch

 When selected, this switch allows editing of VCA assignments for input and analog group channels. In this mode, the selected VCA Group Edit switch will illuminate and flash. Only one Edit switch can be selected at a time, and selection of the VCA Group Edit Switch will override any SOLO switch selected (solo clear). To exit VCA Edit Mode, press the selected (illuminated and flashing) switch to toggle it to the off position.

Whenever a VCA Group Edit switch is flashing, the SOLO-VCA EDIT switches will flash on all input and group channels assigned to that VCA group.

For a complete discussion of VCA group editing, see section on VCA Group Operation.

VCA SOLO switch

 When selected, this switch illuminates and activates all input and audio group SOLO switches assigned to that VCA group. All channels are monitored within the solo system as a related group. The VCA SOLO system also may be used to quickly review VCA assignments, though no modification of assignment is permitted.

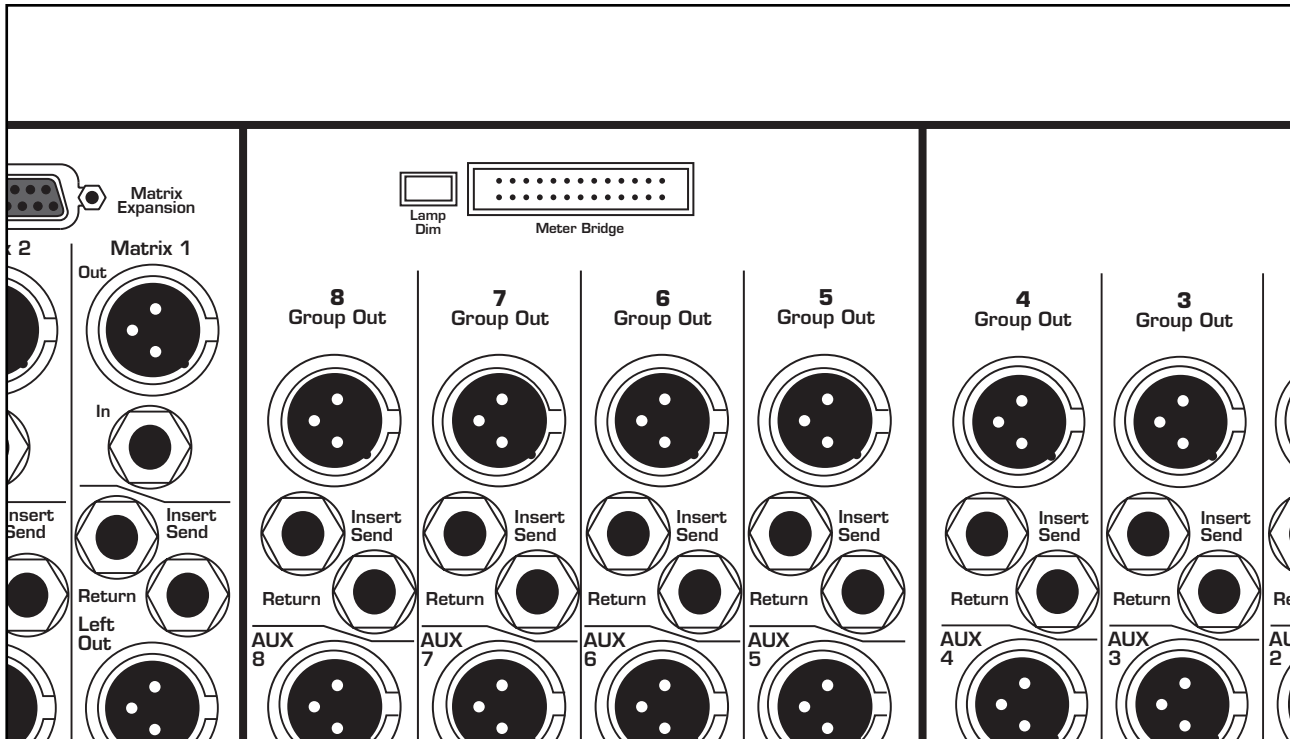

rear panel features

lamp dim

- Goose-neck lamps light-up at full intensity.
- Goose-neck lamps light-up at medium intensity.

meter bridge connector

This connector carries all of the required connections up to the meter bridge. While patching the console, care should be taken not to damage this connector or the ribbon that plugs into it.

3 group module

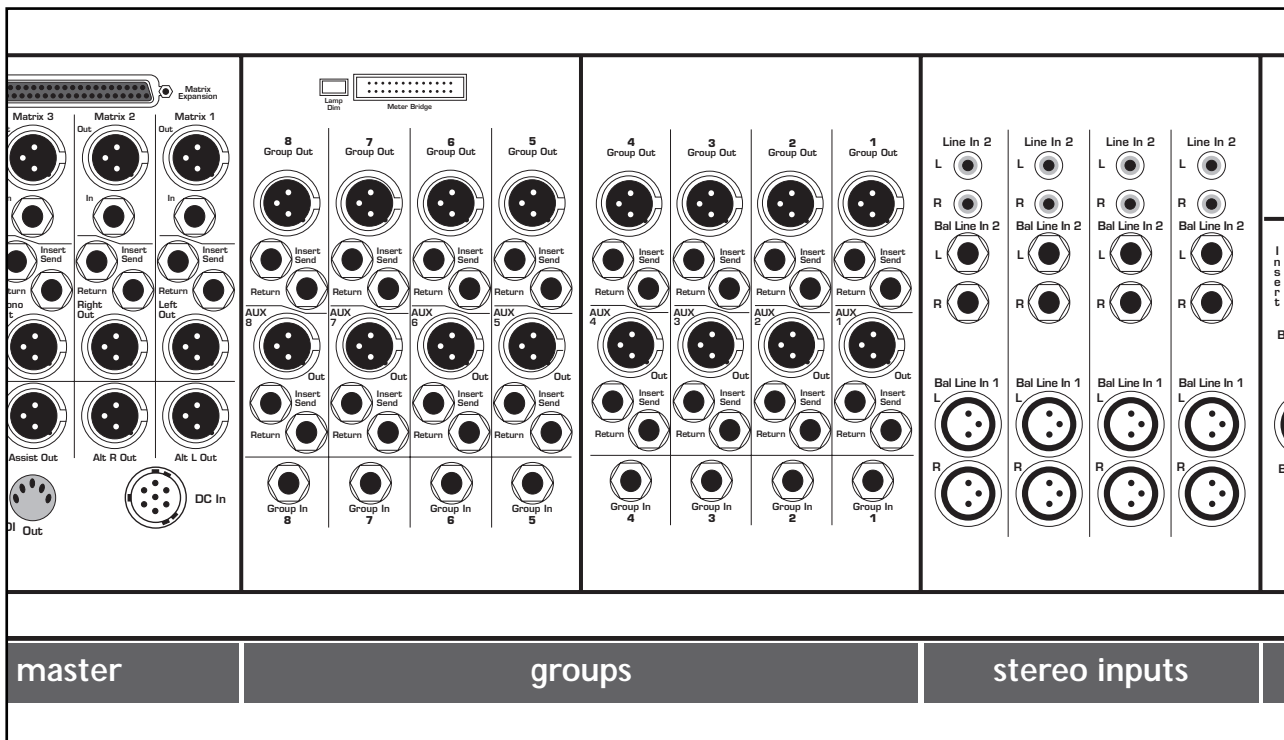
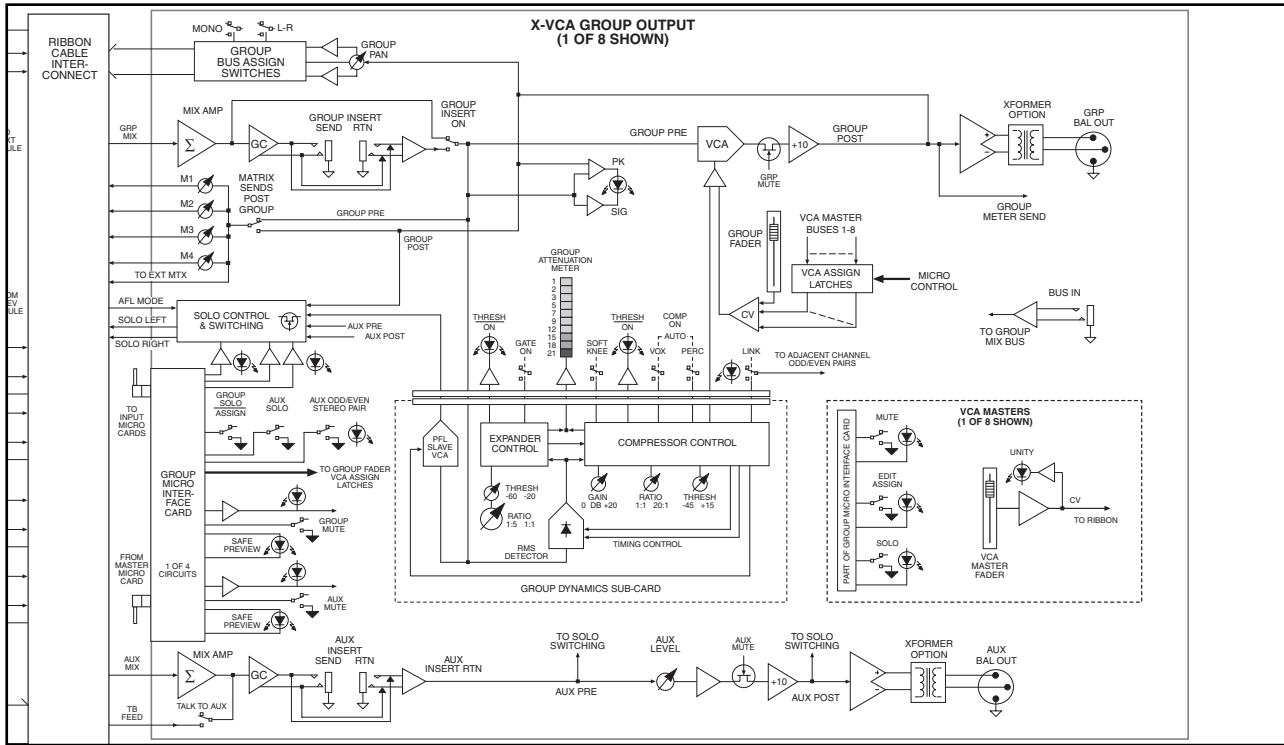

rear panel features

group output



This balanced male XLR connector carries the GROUP output signal. see—group fader, front-panel description

group insert point

Separate 1/4" TRS jacks provide the ability to insert an external signal processor into the signal path of the GROUP. Insert is made active by depressing Group Insert ON switch.

group insert send

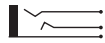

This output connects to the input of an external signal processor. The signal is derived after the group-summing amplifier. This output is ground compensated.

group insert return

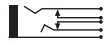

This balanced input accepts a signal from the output of an external signal processor. It accepts either balanced or unbalanced signals.

aux output



This balanced male XLR connector carries the AUX output signal. see—aux master, front-panel description

aux insert point

Separate 1/4" TRS jacks provide the ability to insert an external signal processor into the signal path of the AUX. Insert is made active when a 1/4" TRS connector is plugged into the Aux Insert return jack.

aux insert send

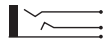

This output connects to the input of an external signal processor. The signal is derived after the aux-summing amplifier. This output is ground compensated. It can also be used as pre-aux master level output without interrupting the normal signal flow through the aux master section.

aux insert return



This balanced input accepts a signal from the output of an external signal processor. It accepts either balanced or unbalanced signals. Inserting a 1/4" TRS plug into this jack makes the aux insert active.

group in

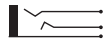

External signal can be introduced to the group by plugging a 1/4" TRS connector into this jack. One primary purpose for the Group in jacks is to link consoles together. The group outputs from another console can be fed into these jacks, linking the group buses of the two consoles.

4 left / right & mono masters

module

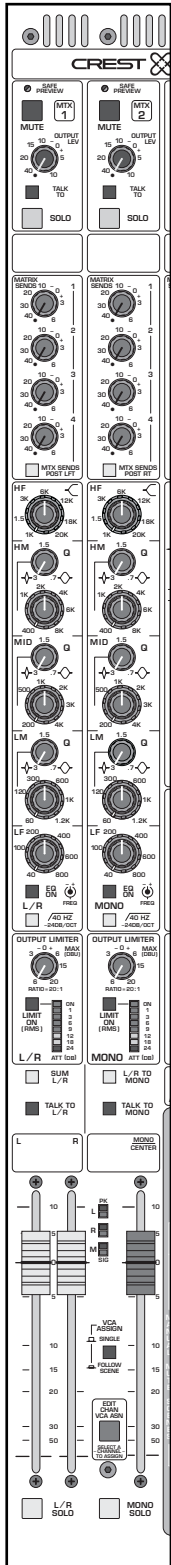

block diagram

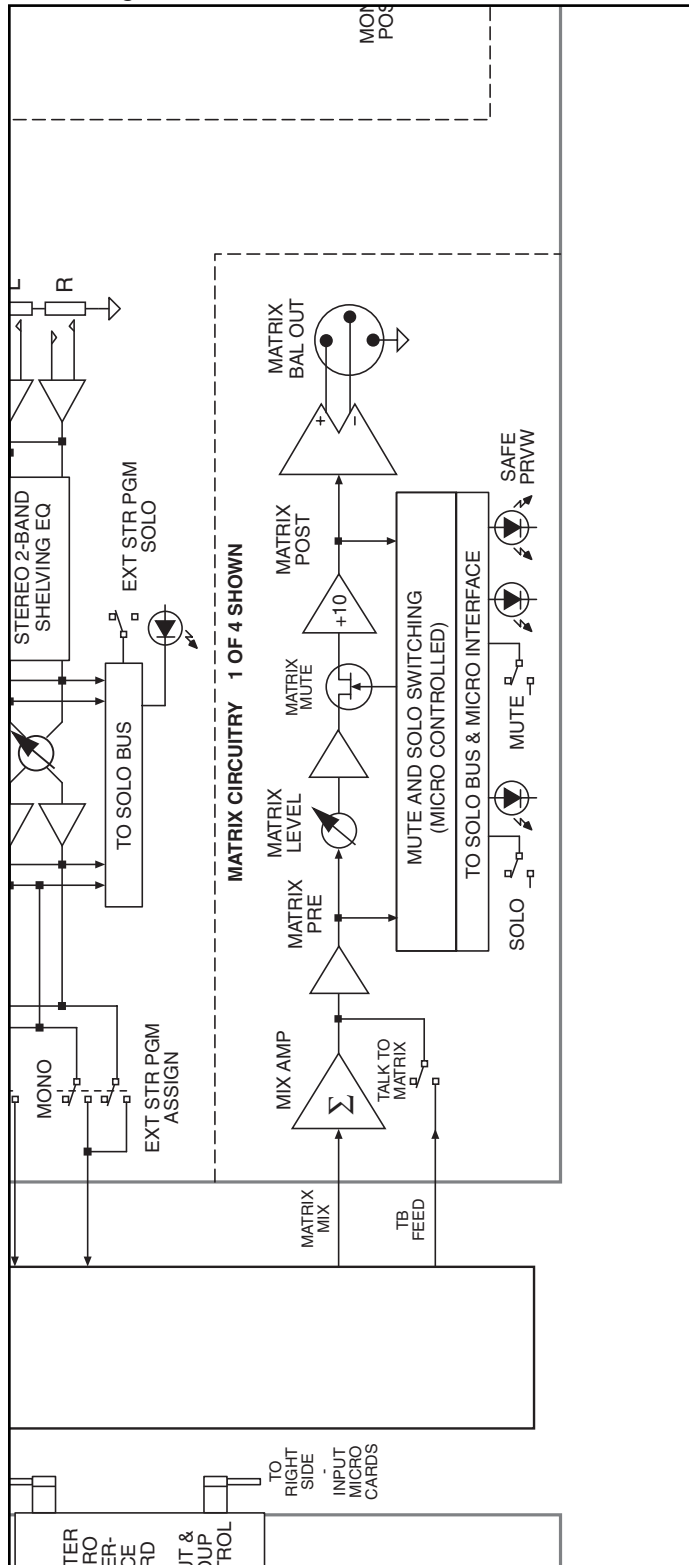

panel

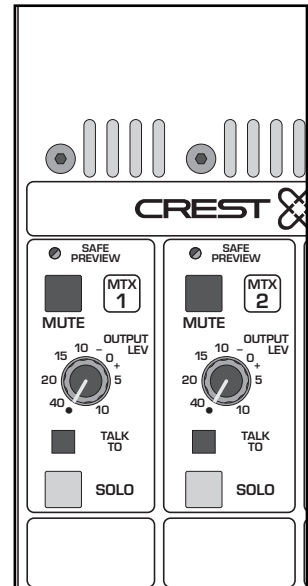

left / right & mono master modules 4

features

Aside from their Left / Right and Mono assignments, the X-VCA Left / Right and Mono master modules contain identical features. One module is devoted to the Left and Right stereo mix and the other module is devoted to the Mono mix. Both modules contain the following sections:

- * Matrix Output Control
- * Matrix Send 1 through 4
- * Output EQ
- * RMS Output Limiter
- * 100mm Faders
- * Microprocessor Mute Controller
- * Solo

Matrix output control

The Left / Right master module contains Matrix Master 1 and the Mono master module contains Matrix Master 2.

mute



Mute switch

See LOCAL MICROPROCESSOR CONTROL section

Matrix master output level



The MATRIX MASTER output level controls set the levels that appear at the corresponding MATRIX output connectors on the rear-panel.

Talk to



Adds the TALKBACK system output to the associated MATRIX output. The level of the TALKBACK signal is set by the TALKBACK level control in the MASTER section.

solo switch



Pressing this momentary switch will include (illuminate) or exclude (not-illuminated) the channel from the consoles solo system.

See SOLO FEATURES section.

write-in label

This label may be written on with a grease-marker, or dry-erase pen and later wiped clean. Masking tape may also be placed on this surface, if desired. If you write on it with a "Sharpie", you may have trouble getting the writing off. If this is the case, your best bet is to wipe the label off with isopropyl (rubbing) alcohol.

4 left / right & mono masters

module

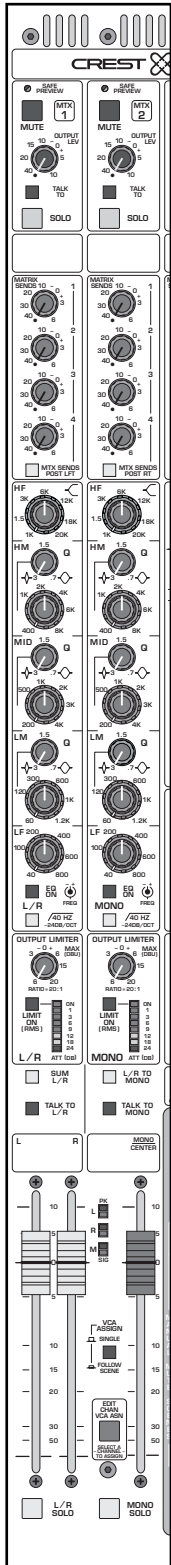

block diagram

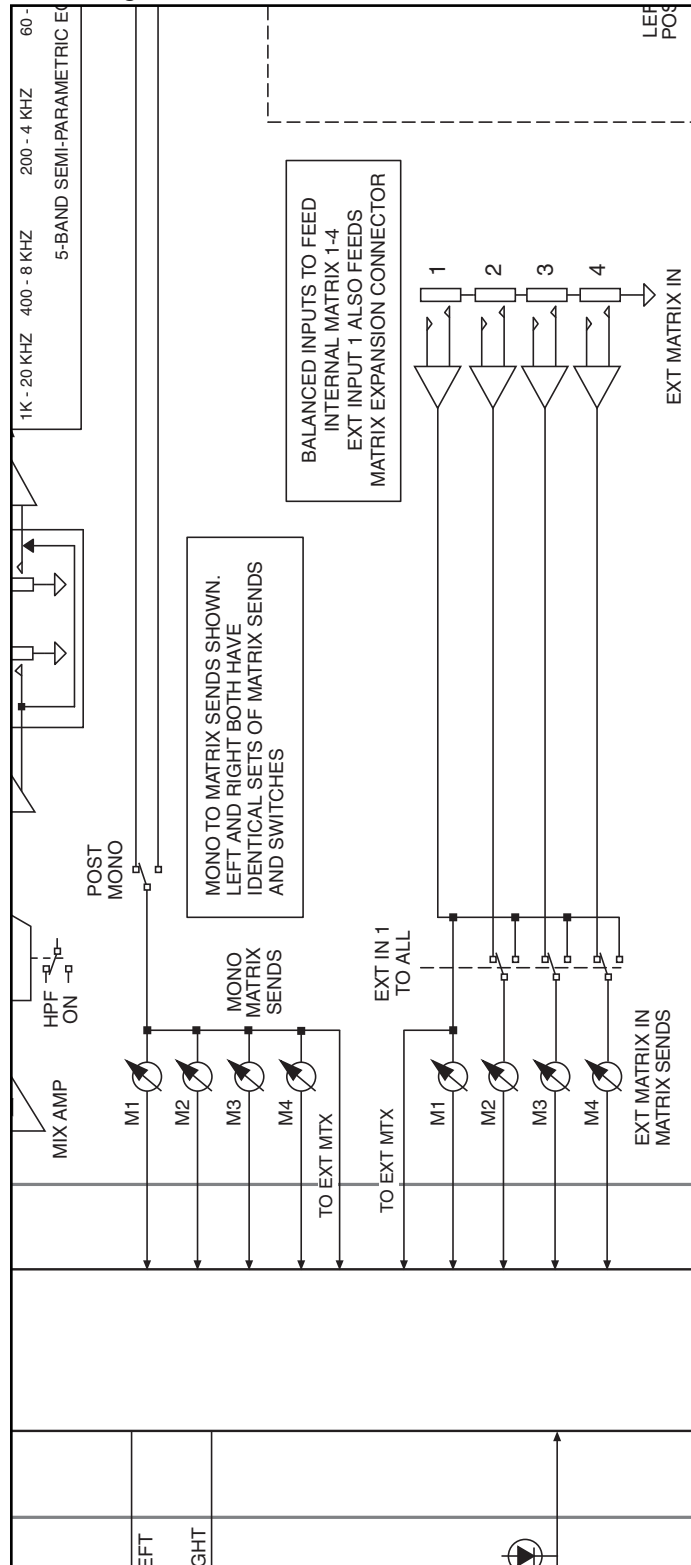

panel

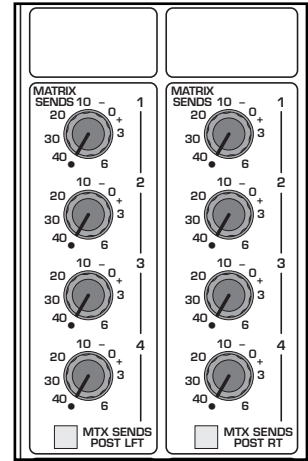

left / right & mono master modules 4

matrix sends

Due to space considerations, the Left Matrix sends are located on the Left / Right master module and the Right Matrix sends are located on the Mono master module. Likewise, the Mono Matrix sends are bumped down one slot and appear in the Master Control section. To make this more clear, refer to the illustration.

matrix 1–4 levels—M1, M2, M3, M4

 These level controls are used to dial the LEFT, RIGHT and MONO signals into the corresponding matrix.

post-group

The LEFT, RIGHT or MONO fader setting has no effect on the group-to-matrix level controls 1–4.

The LEFT, RIGHT or MONO fader is introduced into the signal path and will control the signal level. When the LEFT, RIGHT or MONO is muted, the LEFT, RIGHT or MONO signals to matrix 1–4 are muted as well.

4 left / right & mono masters

module

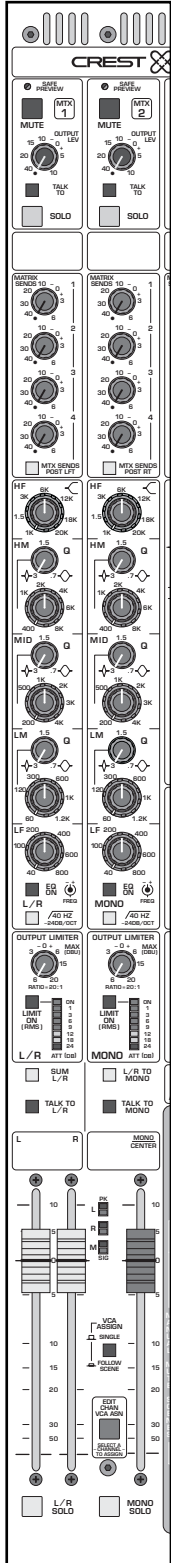

block diagram

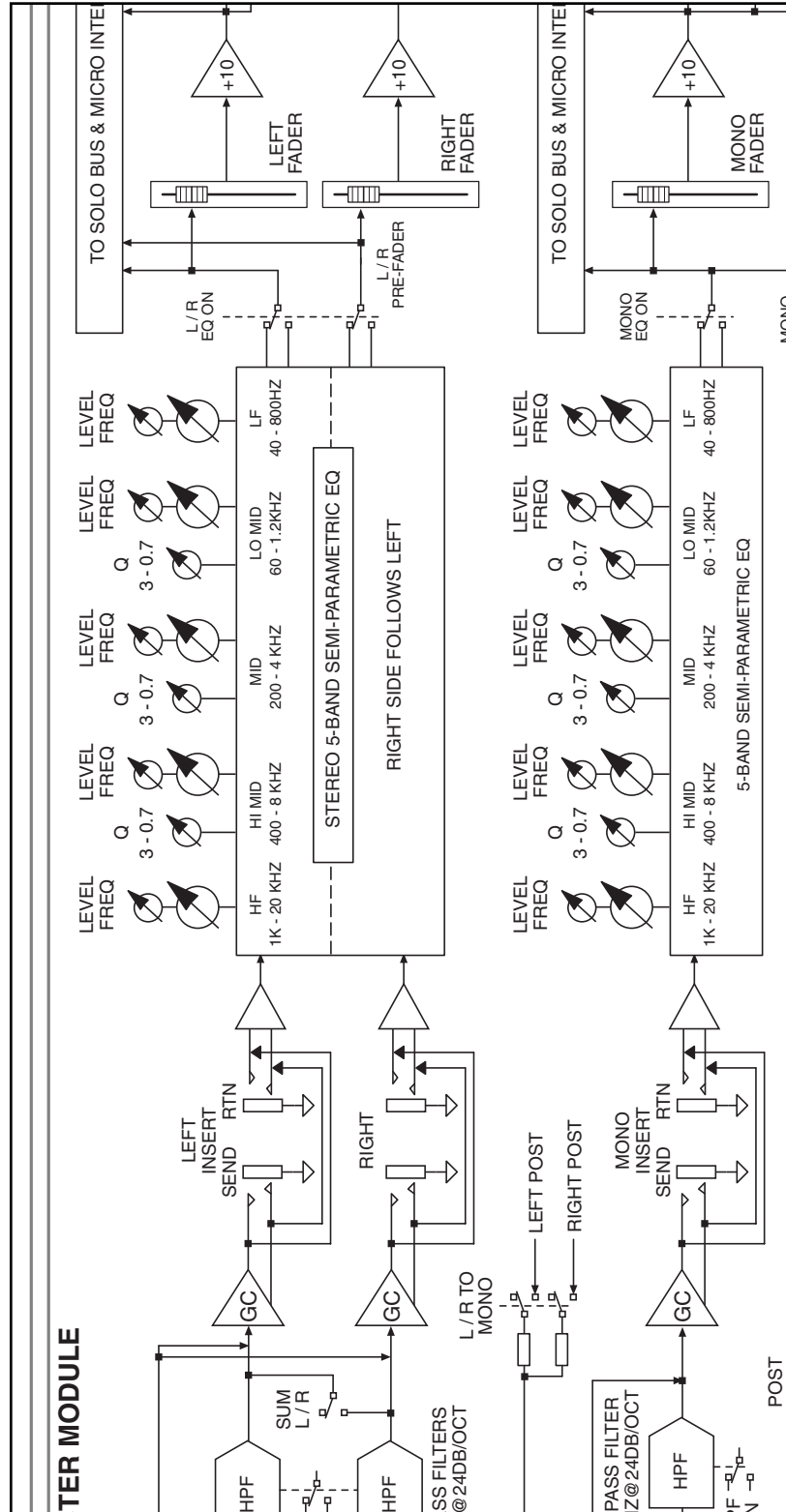

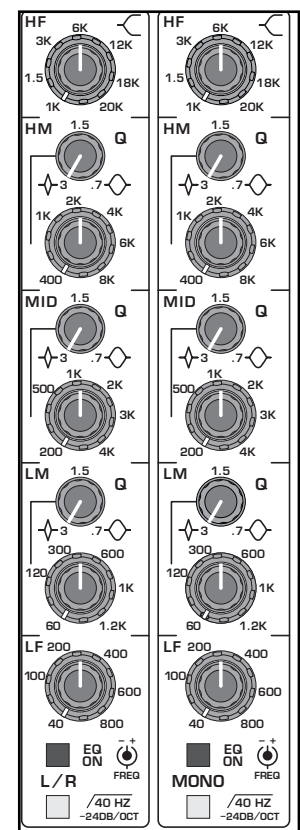

panel





Output EQ features

Independent stereo and mono output EQ sections are provided on X-VCA. The EQ consists of 5 bands and a fixed High pass filter. The High and Low bands are shelving EQ and the High Mid, Mid and Low mid are full parametric. Although the left and right signals are processed separately, the parameters are set in tandem by common front panel controls.



high frequency—HF (shelving eq)

-  **Boost / Cut** (inner knob) 15dB boost and cut.
-  **Frequency** (outer knob) Continuously sweepable between 1kHz and 20kHz



high mid—HM

-  **Bandwidth** A Q range of 3.0 to 0.7 (0.5 octave to 2.0 octave) is available.
-  **Boost / Cut** (inner knob) 15dB boost and cut.
-  **Frequency** (outer knob) Continuously sweepable between 400 Hz and 8 kHz.



mid—MID

-  **Bandwidth** A Q range of 3.0 to 0.7 (0.5 octave to 2.0 octave) is available.
-  **Boost / Cut** (inner knob) 15dB boost and cut.
-  **Frequency** (outer knob) Continuously sweepable between 200 Hz and 4 kHz.

Low mid—LM

-  **Bandwidth** A Q range of 3.0 to 0.7 (0.5 octave to 2.0 octave) is available.
-  **Boost / Cut** (inner knob) 15dB boost and cut.
-  **Frequency** (outer knob) Continuously sweepable between 60 Hz and 1.2 kHz.

Low frequency—LF (shelving eq)

-  **Bandwidth** A Q range of 3.0 to 0.7 (0.5 octave to 2.0 octave) is available. Turning the control full clockwise switches operation to a plus/minus shelving mode.
-  **Boost / Cut** (inner knob) 15dB boost and cut.
-  **Frequency** (outer knob) Continuously sweepable between 40 Hz and 800 kHz.

eq on

Equalizer is on. This switch is used to activate the EQ section and can be used to make A/B comparisons between "flat" and eq'd signals.

high-pass filter—HPF

The high pass filter HPF has a fixed cut off frequency of 40Hz and a 24dB per octave slope.

HPF

High-pass filter is on.

4 left / right & mono masters

module

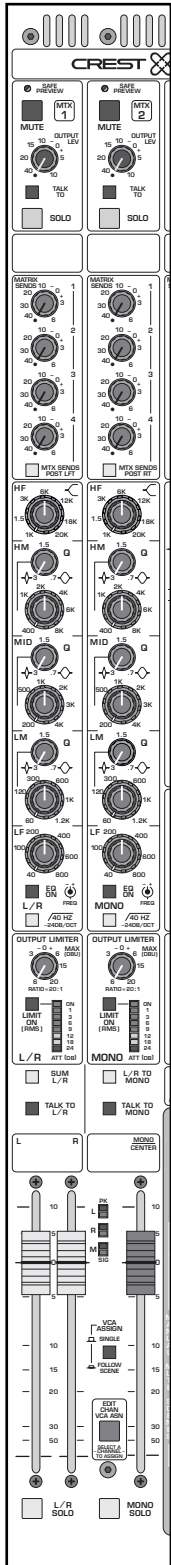

block diagram

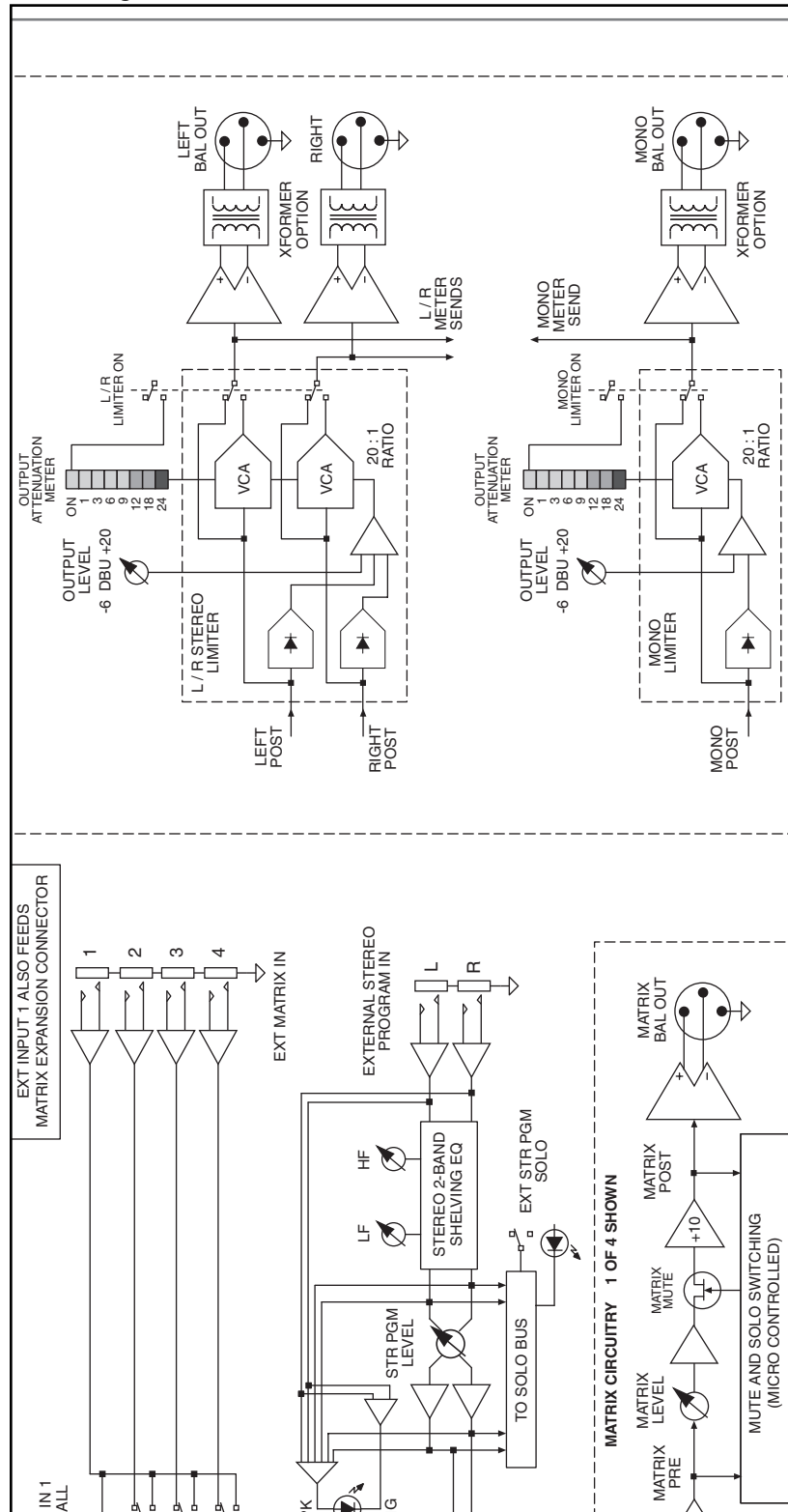

panel

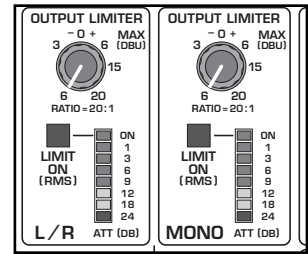

output limiter features

The L/R and Mono outputs are equipped with independent output limiters. The limiters are located AFTER the console output faders and only affect the signals that appear at the main Left, Right and Mono XLR's.

Limiting takes place according to the RMS level, allowing short term signal peaks to pass without attenuation. Limiters may be used for speaker protection, or to prevent the system from producing sound levels that exceed local noise ordinances. The Left and Right signals are processed together by the Left / Right limiter (located above the Left / Right master faders) and the Mono signal is processed by the Mono limiter (located above the Mono master fader).

The features for both the Stereo and Mono limiters are identical.

output limiter threshold control

 Adjusts the limit point. Any signal level beyond this point will cause attenuation at a ratio of 20:1. The limiter circuit provides "soft knee" limiting. This means that when a signal approaches the limit point, a certain amount of dynamic compression is applied in order to soften the effects of the limiter. Hard limiting occurs when the incoming signal is continuously above the limiter threshold. The threshold is adjustable from -6 to +20 dBu.

output limiter on switch

 Activates the output limiter. When activated, the LED at the top of the Gain Reduction meter is alluminated.

gain reduction metering

 This eight segment meter indicates how much limiting, or signal attenuation is taking place. Since the meter is showing attenuation, the LED's illuminate downward, and not upward as one would expect with a level increase. The range displayed by the gain reduction meter is between 1 and 24 dB of attenuation. The top LED illuminates when the Output Limiter is on. The other seven LED's respond to signal attenuation.

For more information, see the section on Gates, compressors and limiters.

Note: Caution should be exercised if a significant amount of gain reduction is displayed, as this may cause a deterioration in overall sound quality. 

EXTREME CAUTION should be observed when removing or turning off any limiter. Depending on level settings and how much limiting is taking place, an abrupt level change can take place that could startle listeners and even damage speakers. 

4 left / right & mono masters

module

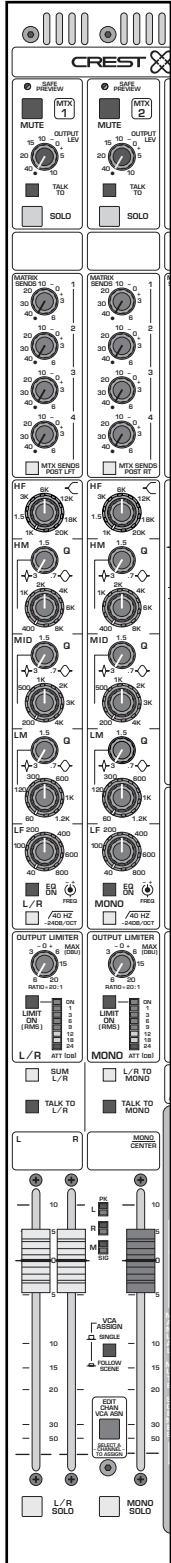

block diagram

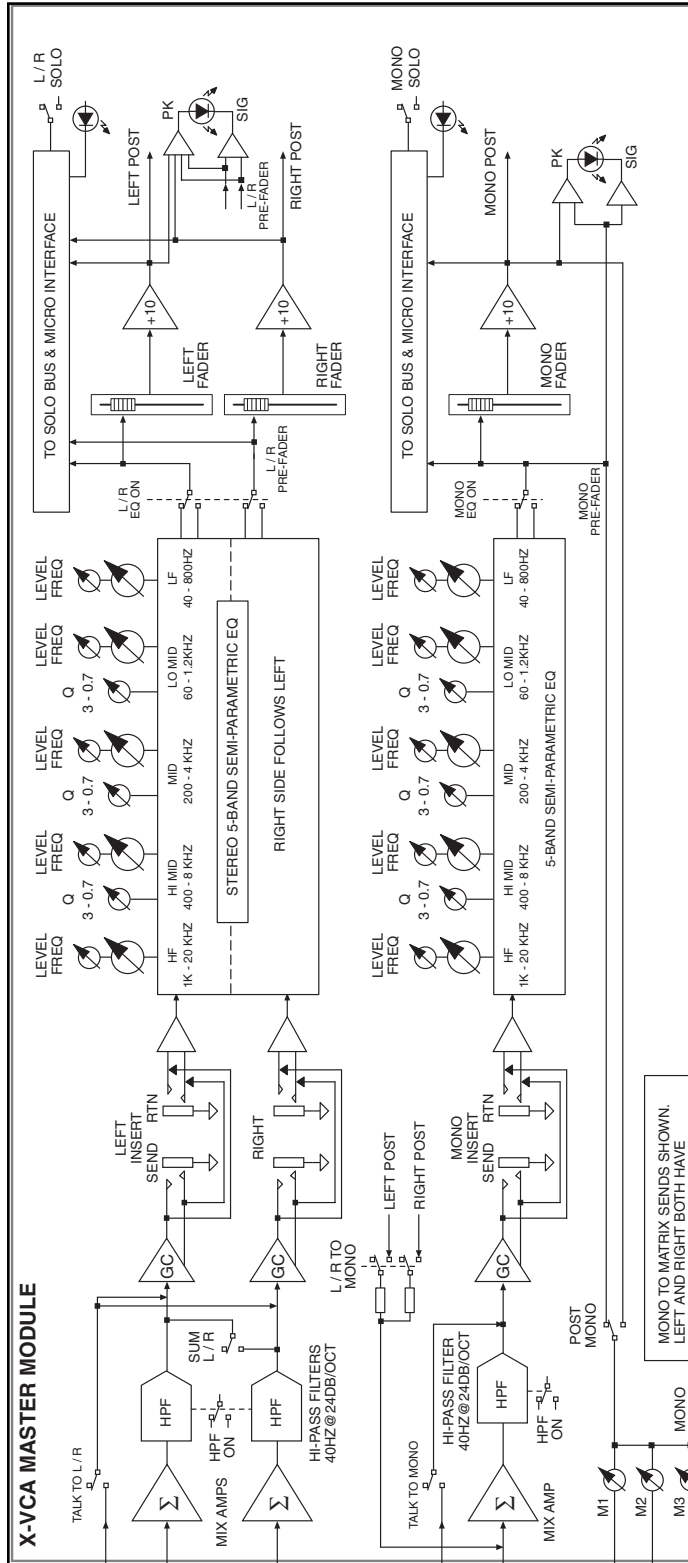

panel

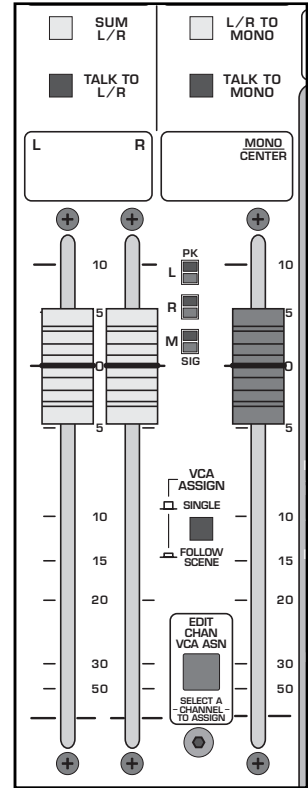

output features

sum L/R switch (Left / Right module)

 Combines the Left and Right outputs into summed mono outputs. This feature is useful when only mono operation is required, making the left and right output connectors available as separate line drivers for redundancy.

L/R to Mono switch (Mono module)

 Assigns the post fader left and right signals to the mono mix bus. This feature is useful for driving a separate mono subwoofers or delay stacks when signal content and level must follow the L/R outputs. If the Left / Right limiter is being used, it will not affect the signals being assigned by this switch.

talk to L/R switch (Left / Right module)

 Assigns the TB (Talkback) signal to the Left and Right masters. The TB signal is introduced after the High pass filters and before the Insert sends. Note - The TB On switch must be depressed and signal must be selected (pink noise or oscillator) or applied (TB input) in order for the Talkback to be heard.

talk to MONO/CENTER switch (Mono module)

 Assigns the TB (Talkback) signal to the Mono master. The TB signal is introduced after the High pass filter and before the Insert send. Note - The TB On switch must be depressed and signal must be selected (pink noise or oscillator) or applied (TB input) in order for the Talkback to be heard.

write-in label

This label may be written on with a grease-marker, or dry-erase pen and later wiped clean. Masking tape may also be placed on this surface, if desired. If you write on it with a "Sharpie", you may have trouble getting the writing off. If this is the case, your best bet is to wipe the label off with isopropyl (rubbing) alcohol.

Left and Right signal LED indicators

Each of the Main outputs (Left, Right and Mono) have an identical pair of LED indicators to show signal level an peak status.

peak indicator - PK

 (Red) The output signal is monitored both before and after the master fader. Overloads at either stage will cause the red peak-LED to light.

signal present indicator—SIG

 (Green) This LED varies in brightness in response to the pre-master fader signal level.

4 left / right & mono masters

module

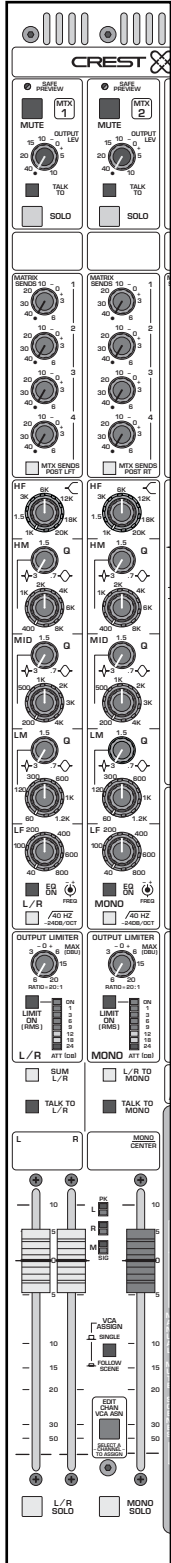

block diagram

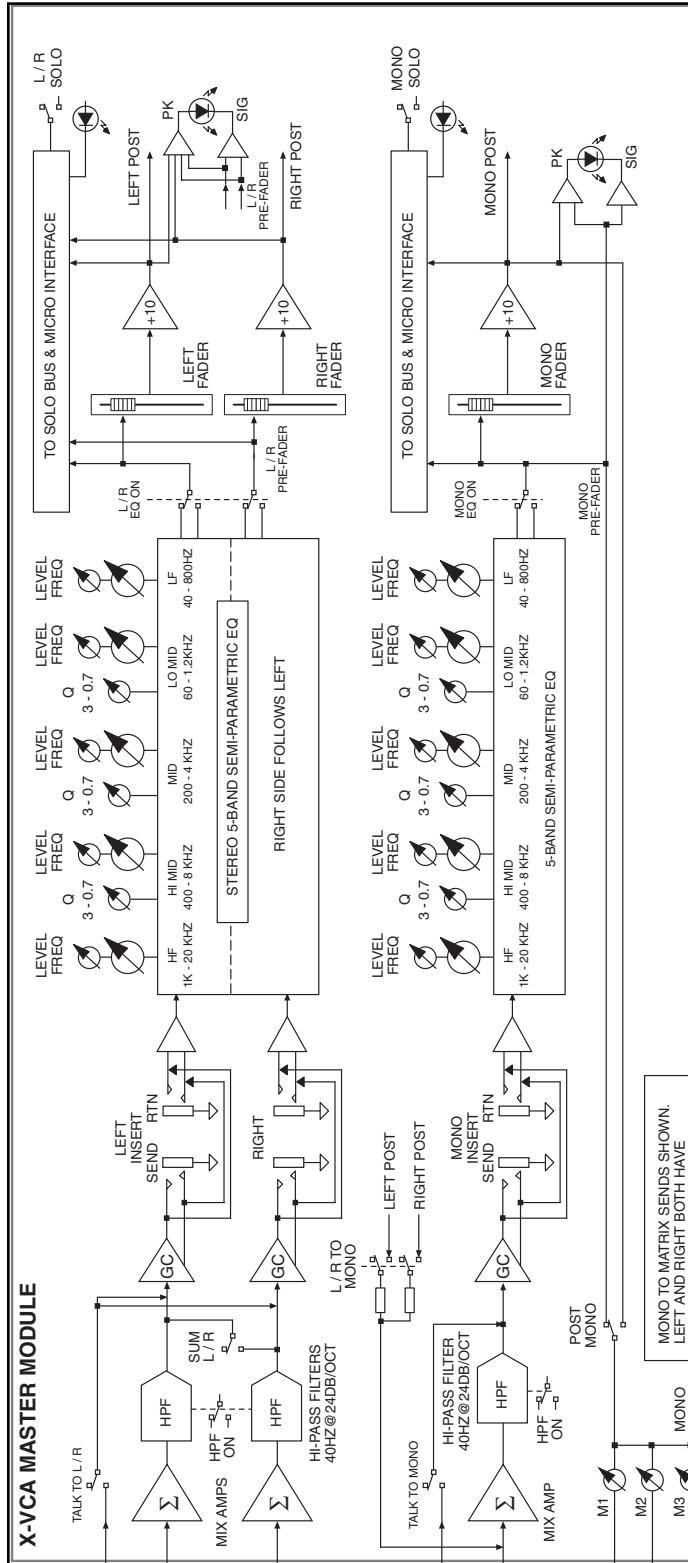

panel

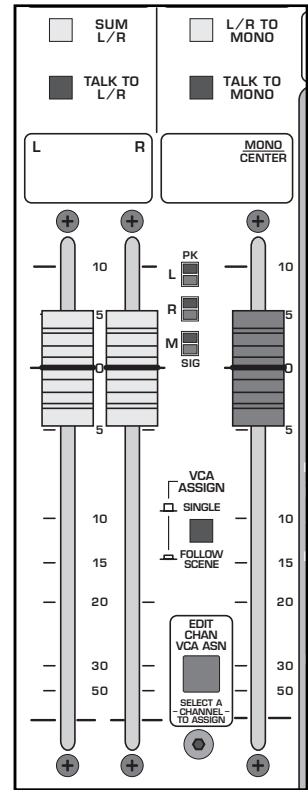

left / right & mono master modules

features

100mm Left, Right and Mono faders

These faders control the overall Left, Right and Mono master output levels. Note that the Left, Right and Mono inserts are located prior to the faders and the limiters are located AFTER the faders.

vca assign switch

This switch makes it possible to include a snapshot of the consoles VCA assignments in each of the 128 micro mute scenes.

 The VCA assignments function just as they do on a conventional VCA console. There is no connection between the VCA assignments and the micro mute section.

 Along with each of the 128 micro mute scenes, a snapshot of the consoles VCA assignments is included.

For more information, see the section on VCA group assignments.

edit channel vca assign switch

 Pressing this momentary switch puts the console into a VCA edit mode - Edit by channel. This mode allows you to choose a channel, then decide what VCA's it is assigned to.

For more information, see the section on VCA Group Operation.

l/r and mono solo switches

 Pressing this momentary switch will include (illuminate) or exclude (not-illuminated) the channel from the consoles solo system.
See **SOLO FEATURES** section.

rear panel features

See the rear panel features for the Master control section.

5 master control section

module

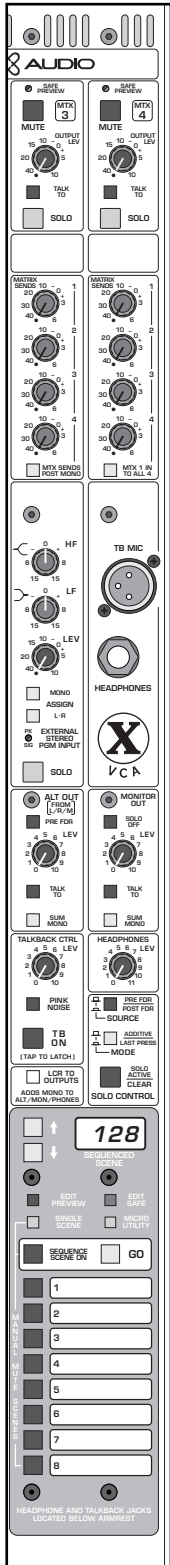

block diagram

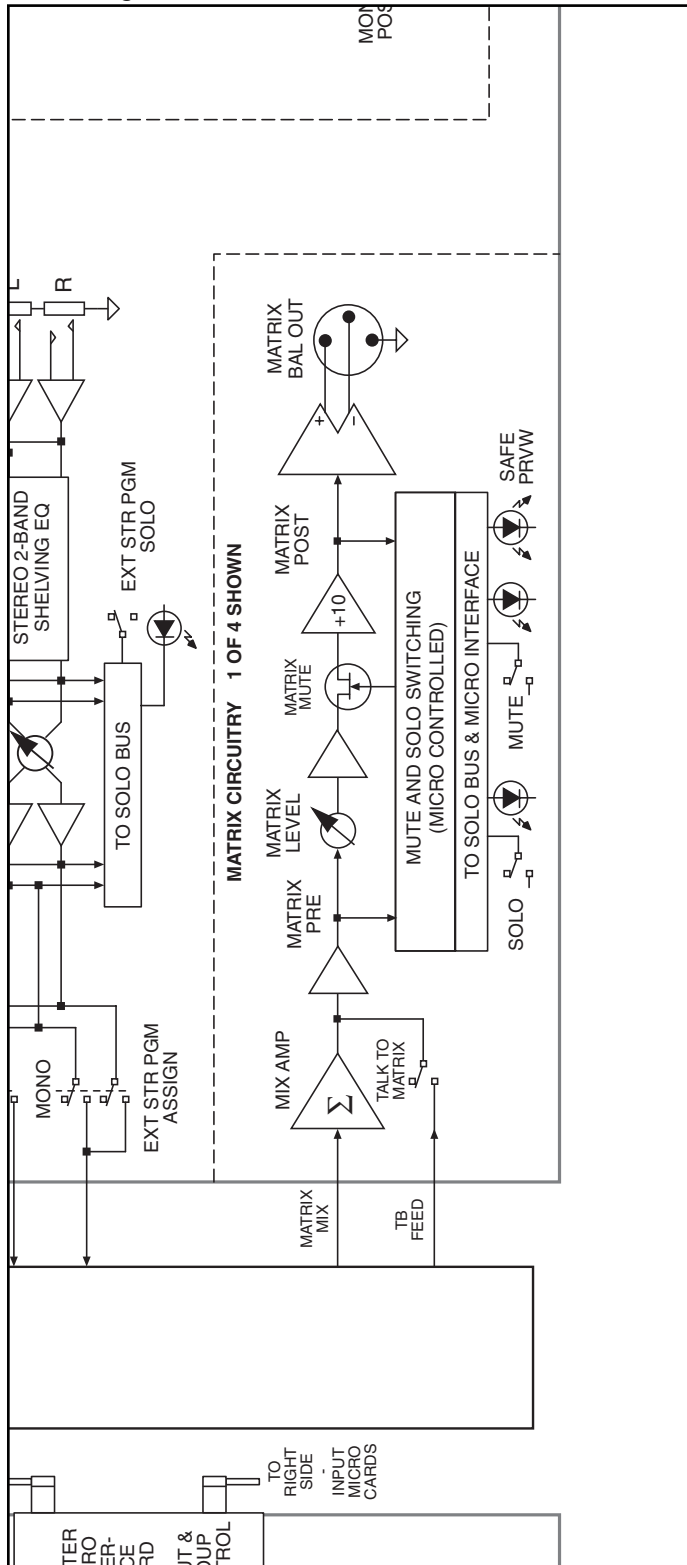

panel

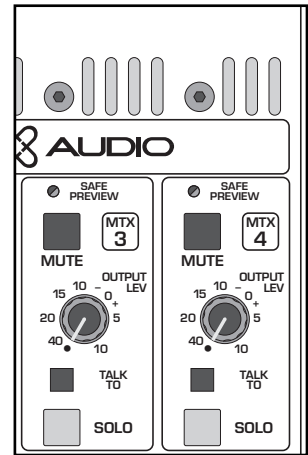

features

The Master control section offers some flexible signal routing solutions as well as utilitarian functions. Also included is the Microprocessor section, which is described separately in its own chapter. The master control section includes the following features:

- * Matrix Output Control
- * Matrix Send 1 through 4
- * External stereo program input with EQ
- * Talkback input and control
- * Alternate output and Monitor output control
- * Headphone and solo control features

Matrix output control

The the master control section contains Matrix Masters 3 and 4.

mute



Mute switch

See LOCAL MICROPROCESSOR CONTROL section

Matrix master output level

 The MATRIX MASTER output level controls set the levels that appear at the corresponding MATRIX output connectors on the rear-panel.

Talk to

 Adds the TALKBACK system output to the associated MATRIX output. The level of the TALKBACK signal is set by the TALKBACK level control in the MASTER section.

solo switch

 Pressing this momentary switch will include (illuminate) or exclude (not-illuminated) the channel from the consoles solo system.
See SOLO FEATURES section.

write-in label

This label may be written on with a grease-marker, or dry-erase pen and later wiped clean. Masking tape may also be placed on this surface, if desired. If you write on it with a "Sharpie", you may have trouble getting the writing off. If this is the case, your best bet is to wipe the label off with isopropyl (rubbing) alcohol.

5 master control section

module

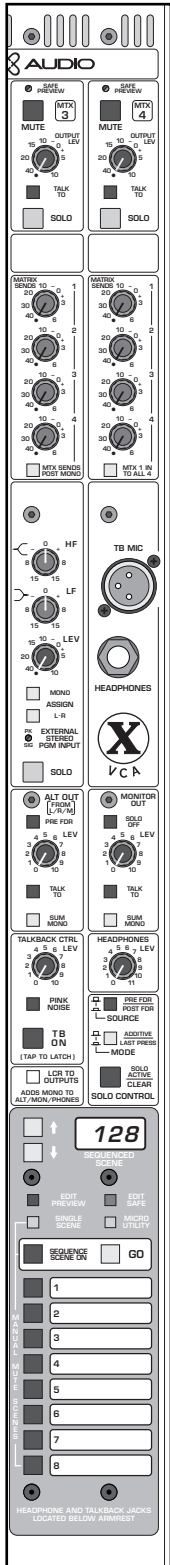

block diagram

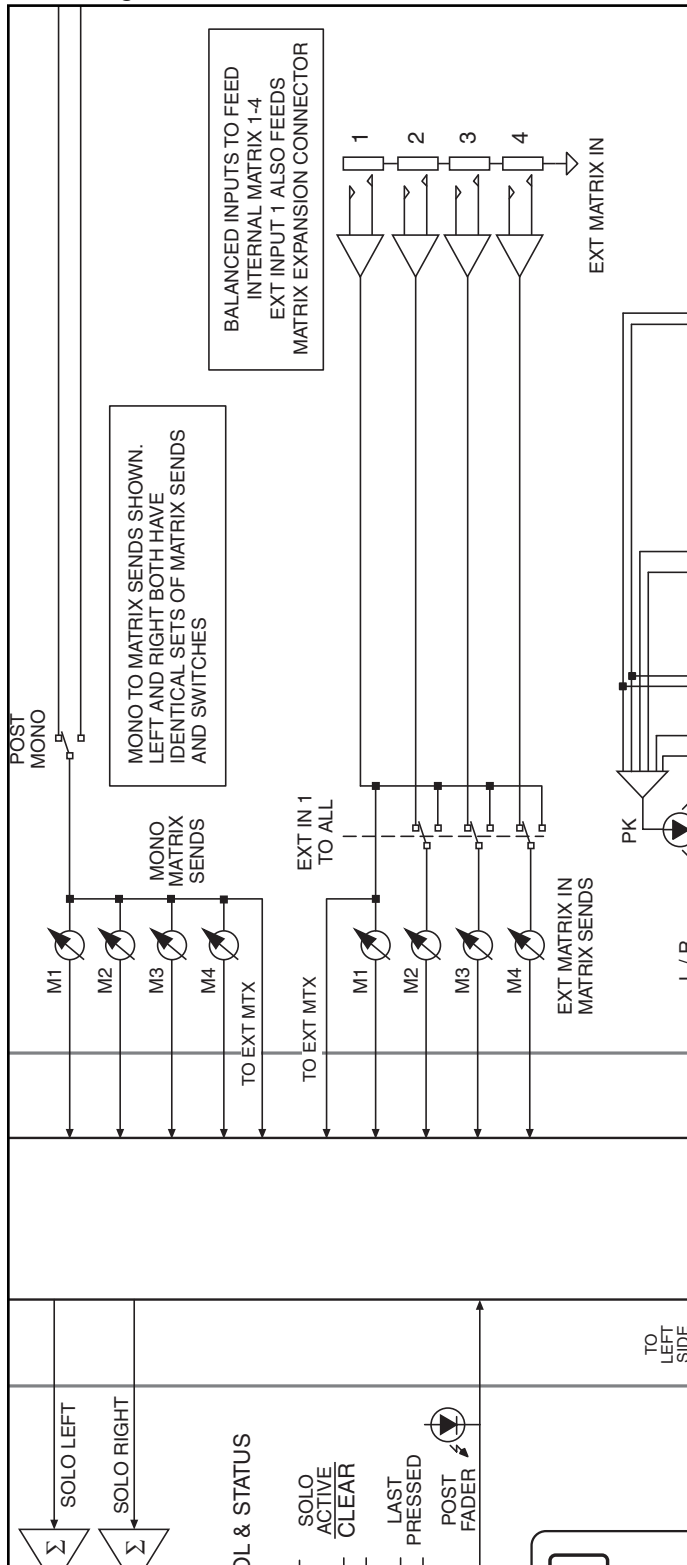

panel

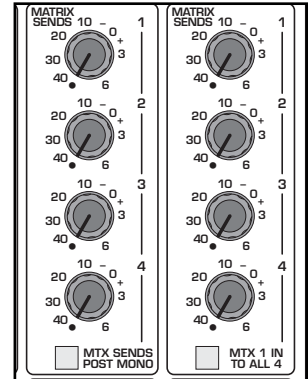

matrix sends

The master control section contains two sets of Matrix sends. The first set is used to dial the Mono master signal into the four matrix busses. The second set is used to dial external signals into the four matrix busses.

mono matrix 1–4 sends

 These level controls are used to dial the MONO signal into the corresponding matrix busses.

matrix sends post mono

MONO fader setting has no effect on the group-to-matrix level controls 1–4.

The MONO fader is introduced into the signal path and will control the signal level. When MONO is muted, the MONO signal to matrix 1–4 is muted as well.

external input to matrix 1–4 sends

 On the rear panel there are four balanced 1/4" TRS connectors. They are labeled Matrix 1 through 4, one input for each matrix bus. These level controls are used to dial external sources into the corresponding matrix.

matrix 1 in to all 4 switch

The signals fed into the four external matrix inputs appear at their corresponding matrix 1–4 pots, ready to be dialed onto the four matrix busses.

The signal fed into external matrix input 1 is routed to each of the matrix 1–4 pots, ready to be dialed into the four matrix busses. Signals fed into matrix inputs 2, 3 and 4 are disregarded.

5 master control section

module

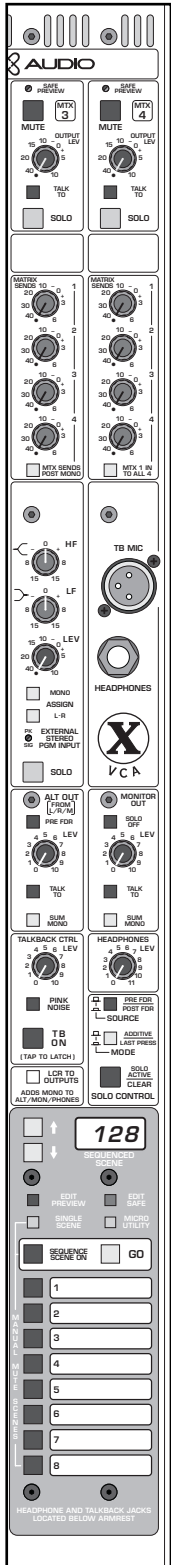

block diagram

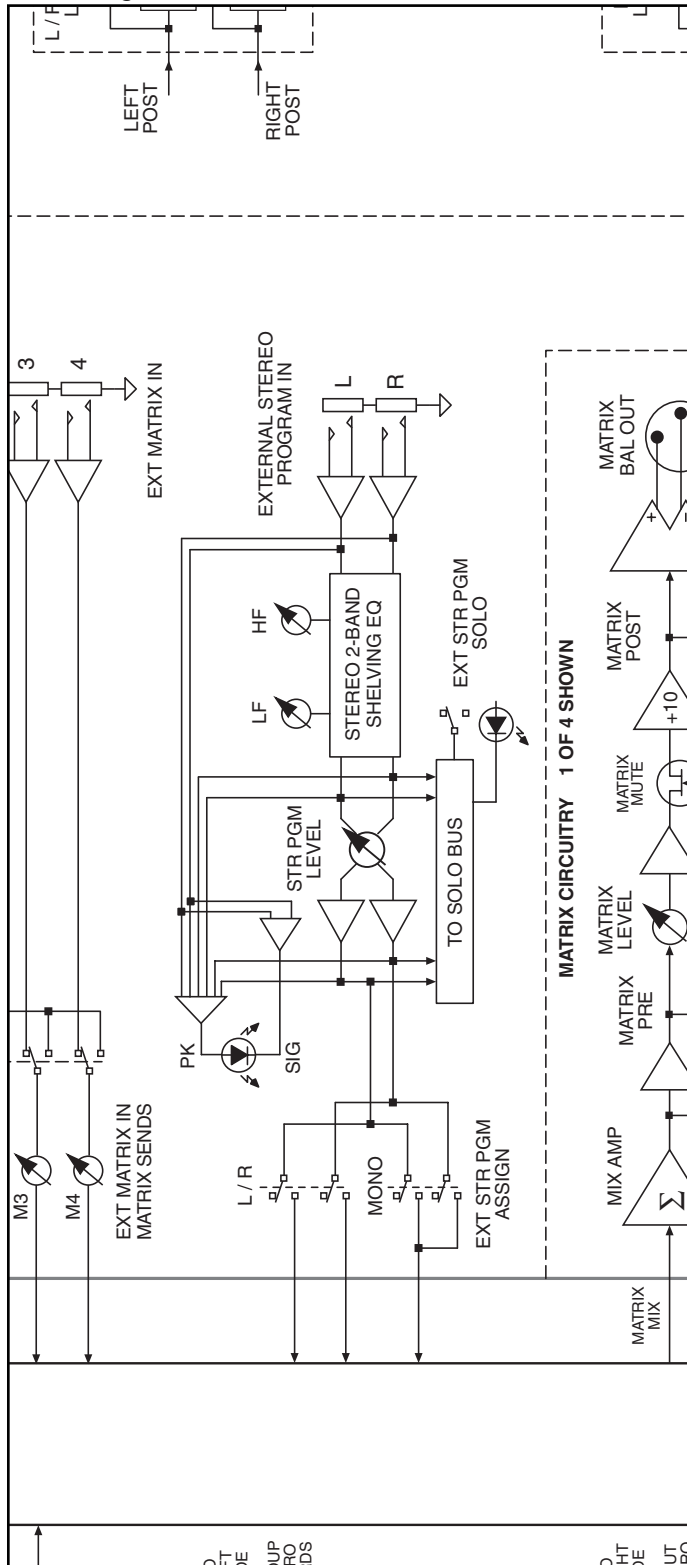

panel

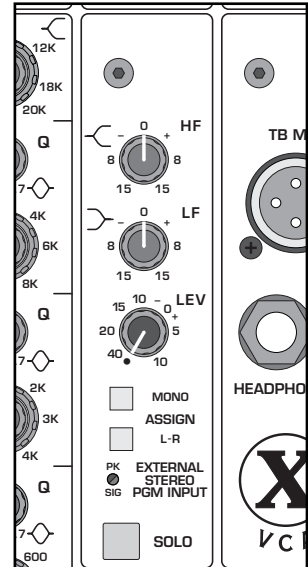

external stereo program input

The external stereo program input allows a line level stereo source to be fed into the console, eq'd and routed to the Left/Right and mono busses. The stereo source can also be monitored through the solo system. This section can be used for stereo returns or for stereo playback through the mains.

external stereo program input eq

The stereo source passes through a basic eq section. The eq controls affect both the left and right signals together.

HF EQ

 15db boost or cut at 12kHz with shelving characteristics

LF EQ

 15db boost or cut at 80Hz with shelving characteristics

program level control

 Adjusts the level of the external stereo program input signal.

mono assignment switch

 The post-level pot external stereo program signals are summed together as a mono signal and are assigned to the mono mix buss with this switch.

L-R assignment switch

 The post-level pot external stereo program signals are assigned to the left and right mix busses with this switch.

peak/signal bi-color LED indicator

 This bi-color LED indicates both peak and signal present conditions. External program input levels within 3dB of overload will cause the RED peak LED to illuminate. (If this should occur beyond an occasional flicker, the external input level should be reduced.) Green illumination of the LED indicates signal is present, and it varies in brightness in response to varying signal levels.

external program Solo switch

 See section on Solo features for more information.

5 master control section

module

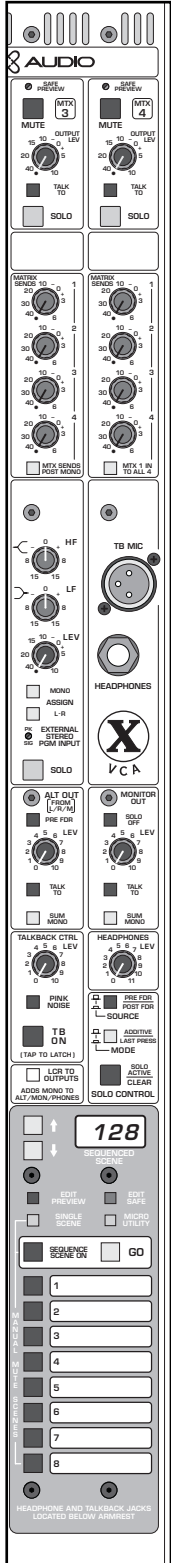

block diagram

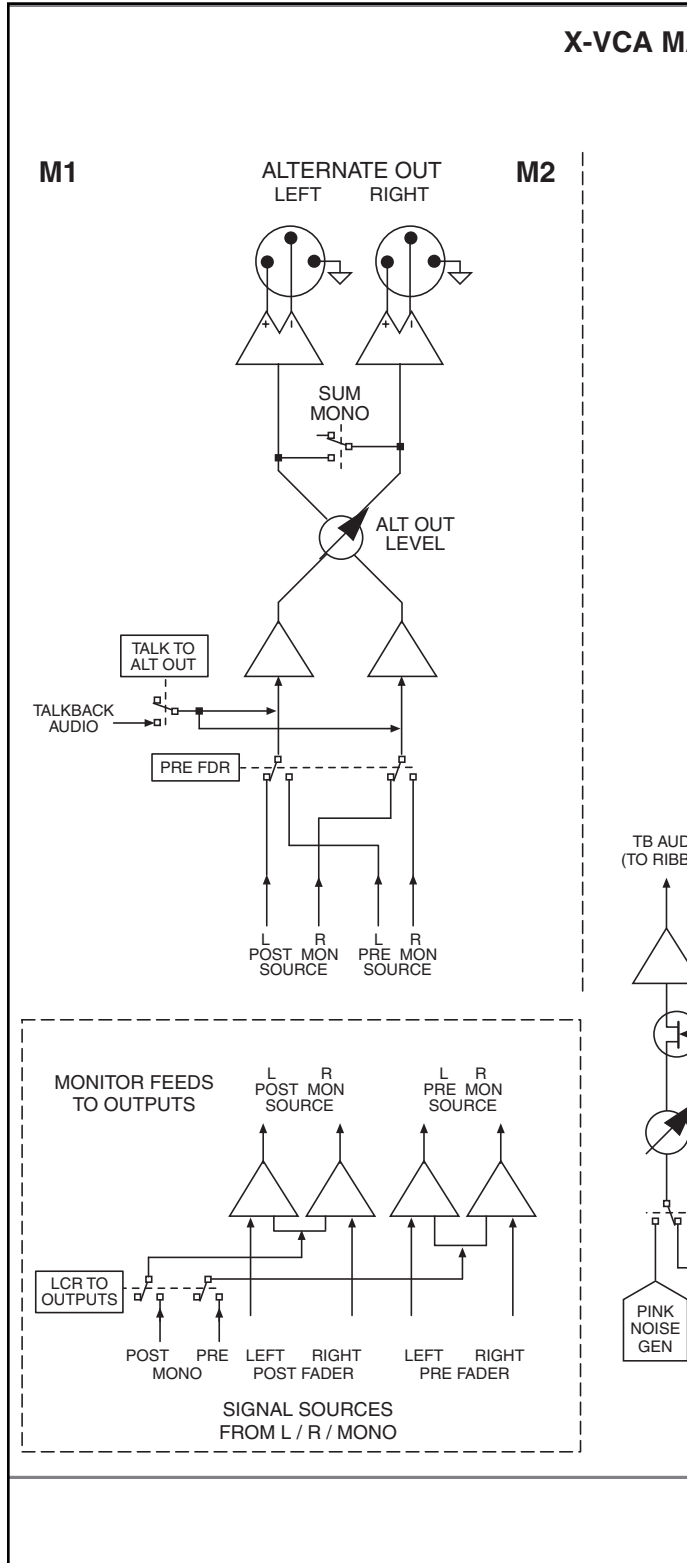

panel

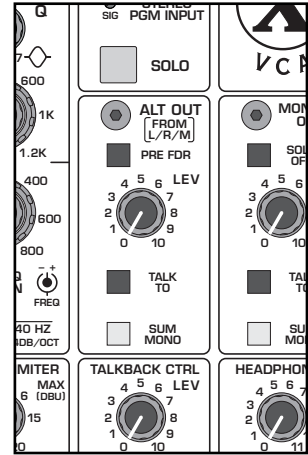

alternate output features

Additional outputs are available beyond matrix and headphone outputs. These outputs are derived from the left, right and mono mix outputs (see LCR to outputs switch). The outputs are available on the rear panel via male XLR connectors.

LCR to outputs switch

Adds the Mono/Center signal to all master section control outputs as a phantom center. This includes the Alternate Outputs, Monitor Outputs, and Headphone Outputs of the console. In addition, it includes the Mono/Center signal in the mono assisted listening output.

alt out (from L/R/M)

A pair of extra outputs for getting the Left, Right and mono signals out of the console.

alternate output PRE FDR switch

Left / Right and mono signals are derived after their designated master faders.

Left / Right and mono signals are derived before their designated master faders.

alternate output level control

 This pot controls the level that appears alternate output XLR's on the rear panel.

Talk to

Adds the TALKBACK system output to the associated alternate outputs. The level of the TALKBACK signal is set by the TALKBACK level control in the MASTER section.

Sum Mono

The left and right signals are summed to mono. The Alt out Left and Right XLRs on the rear panel carry the same mono signal.

The left and right signals stay separate, and appear separately at the Alt out Left and Right XLRs on the rear panel.

5 master control section

module

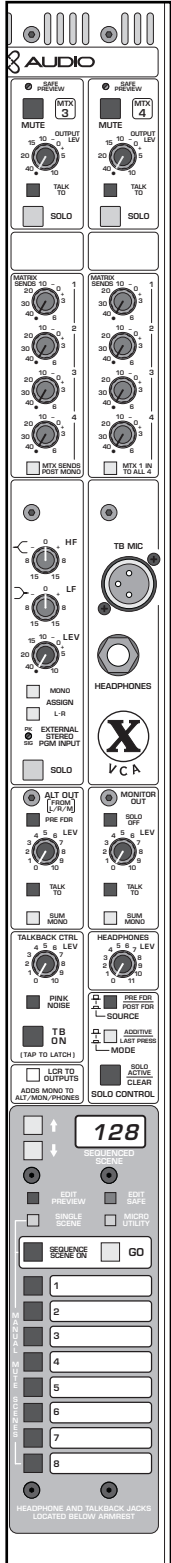

block diagram

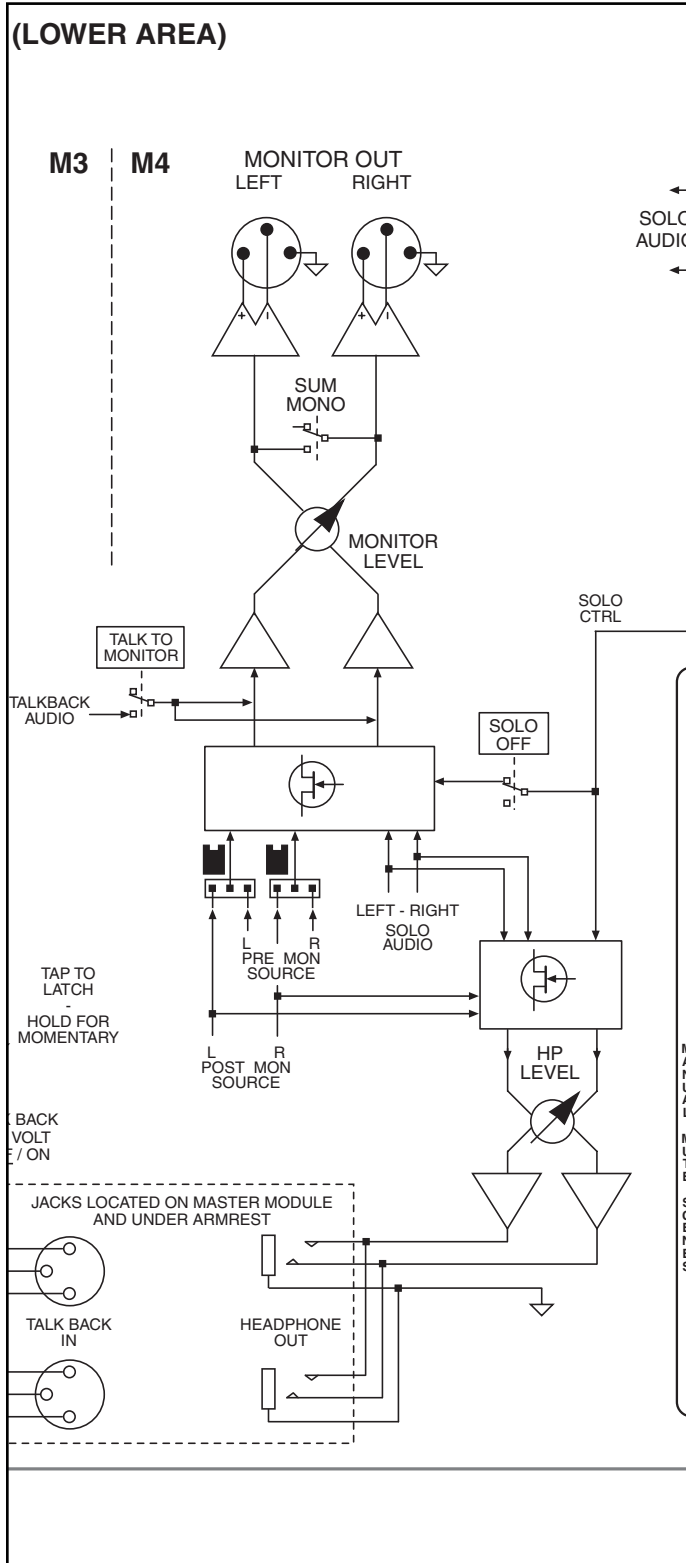

panel

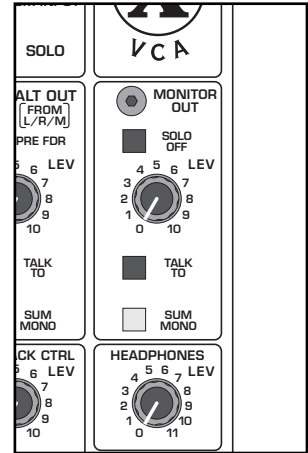

alternate output features

Monitor out

The Monitor out is very similar to the Alt out. Instead of assigning the Left and Right signals to the monitor out, they are always assigned. When the LCR to Outputs switch is depressed, the Mono master signal appears at the Monitor outputs, as well (see above). The solo signal can also appear at the Monitor outputs (see below).

solo off switch

When anything on the console is solo'd, the solo signal appears at the Monitor output and the Left/Right (plus mono/center if selected) signals are muted. When solo is disengaged, the Left/Right (plus mono/center if selected) signals return.

When selected, the solo system no bearing on the Monitor outputs. The Left/Right (plus mono/center if selected) signals are not interrupted. When solo off is selected, this output may be used as an additional set of post fader stereo program outputs.

monitor output level control

 Controls the output levels feeding the monitor output XLR connectors.

talk to

Adds the TALKBACK system output to the associated alternate outputs. The level of the TALKBACK signal is set by the TALKBACK level control in the MASTER section.

Sum Mono

The left and right signals are summed to mono. The Monitor out Left and Right XLRs on the rear panel carry the same mono signal.

The left and right signals stay separate, and appear separately at the Monitor out Left and Right XLRs on the rear panel.

5 master control section

module

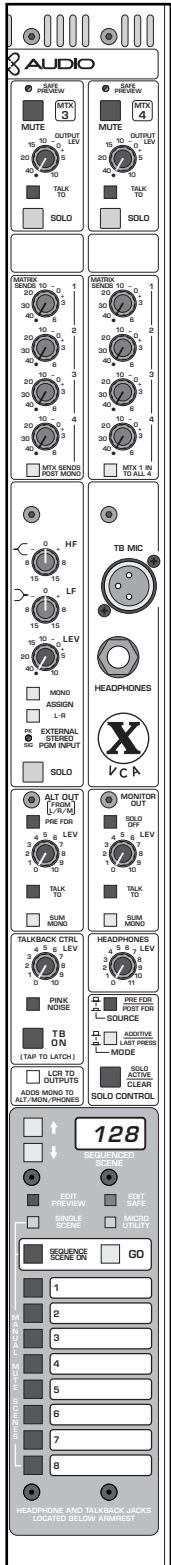

block diagram

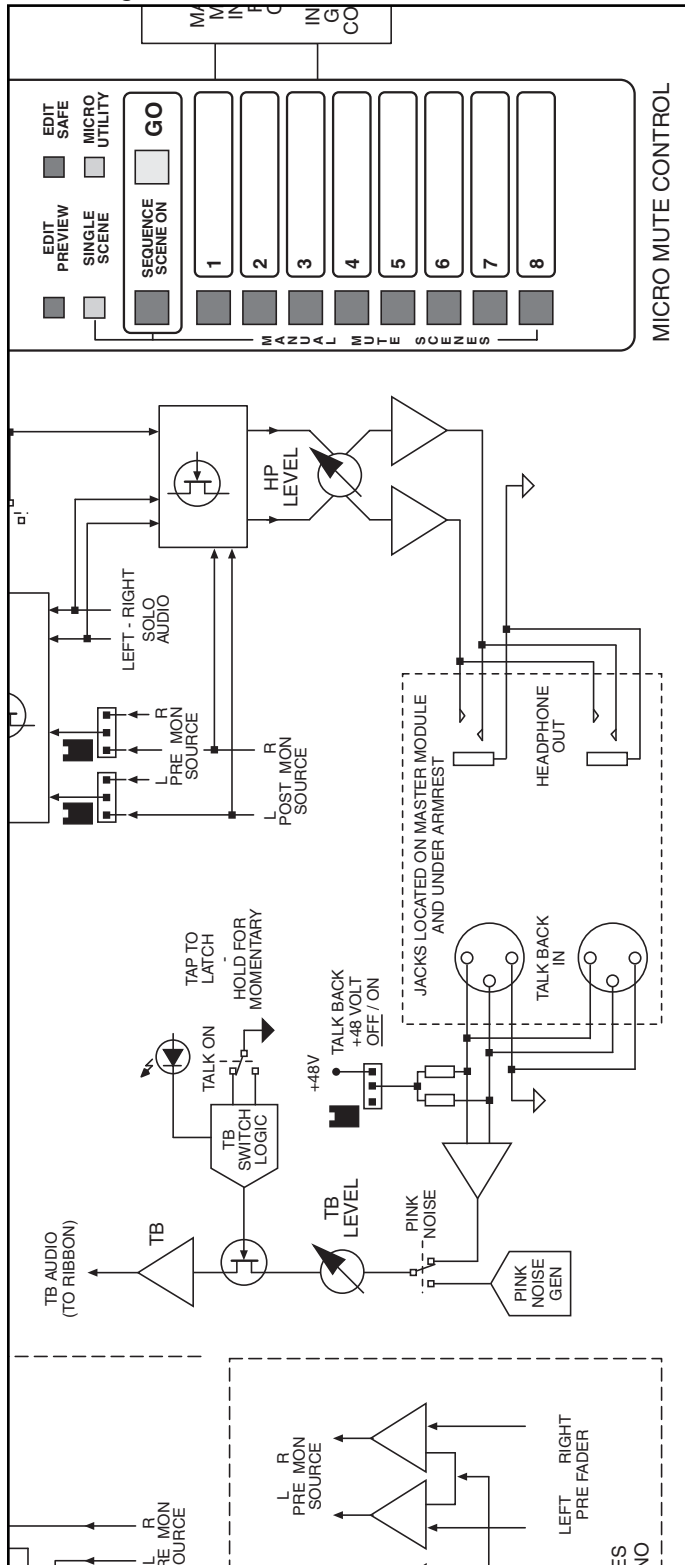

panel

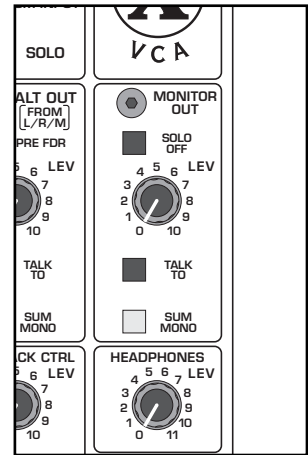

talkback and solo features

talkback control

The talkback section provides the facilities to take either an external input signal, or an internally generated ping noise signal and route it to the consoles outputs. This is useful for making announcements from the mix position and for performing system diagnostics when other signal sources are not readily available.

Talkback control level

 This control sets the level of the talkback signal, whether it is from the external input or consists of the internal pink noise generator.

Pink noise

The talkback control section can get its source signal from three places. The first two are the female XLR mic inputs, one is located on the front panel in the Master control section. The other is located below the consoles armrest, on the right side. The third available source signal is the pink noise generator. The source is determined by the Pink Noise switch. For more information on the Talkback XLR mic inputs, see the master control section rear panel descriptions.

- The talkback control section gets its source signal from either, or both of the Talkback female XLR mic inputs.
- The talkback control section gets its source signal from the internal pink noise generator.

TB ON - Talk back on

This "soft" switch activates the Talkback section. The Talkback section must be activate in order for any of its features to work.

- Tap switch once - This will toggle the Talkback section on and off. Tap once to turn it on, when you're done tap it again to turn it off.
- Press and hold - The switch works as a momentary button. Press it and hold it for more than two seconds. While the button is down, the Talkback section is activated. When you release the button, the Talkback section shuts off.

Headphone level

 This control sets the level that appears at the two headphone jacks. One jack is located on the consoles front panel, next to the TB mic input, and the other jack is located below the armrest.

LCR to Outputs button

- The signals that appears at the Alt outs, the Monitor outs and the headphones do not include the Mono, or center output signal.
- The signals that appear at the Alt outs, the Monitor outs and the headphones include the Mono, or center output signal.

5 master control section

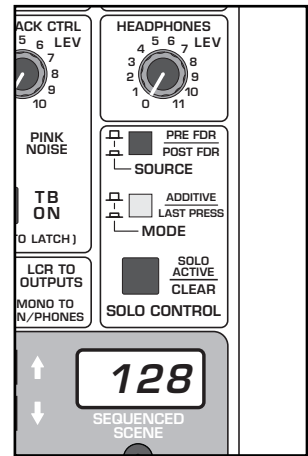
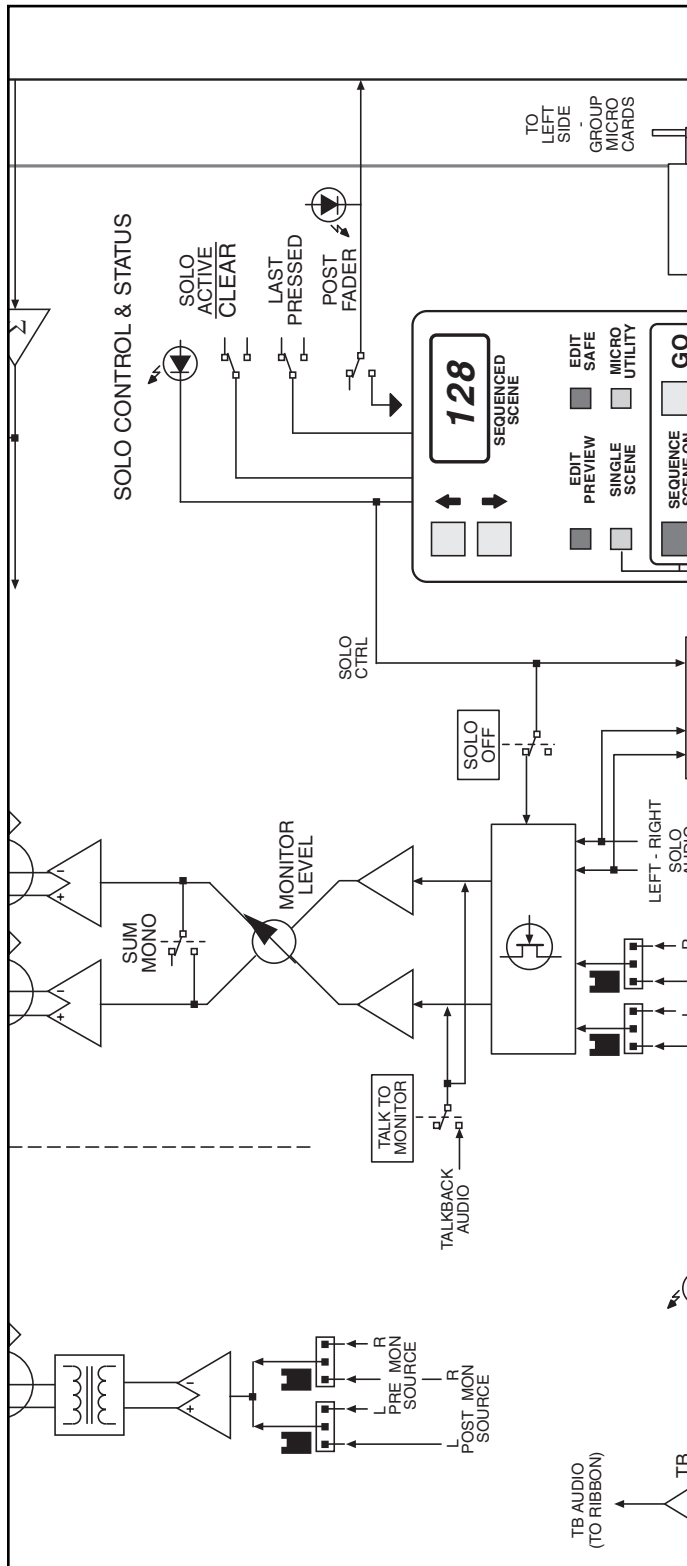
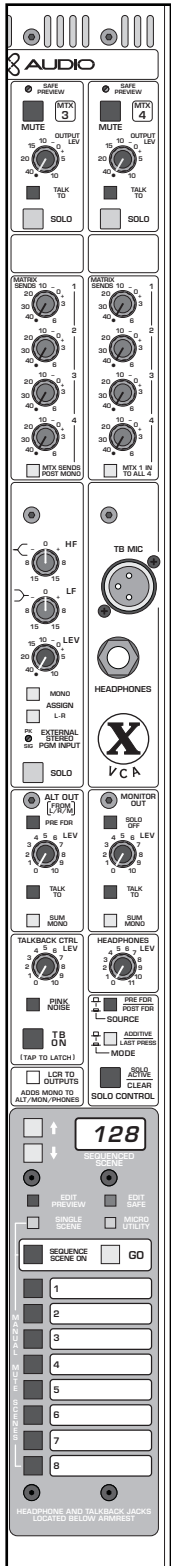

solo features

The X-VCA provides a powerful stereo solo system. Any input or output can be monitored pre (PFL) or after level control (AFL), as desired. The system may be additive (all channels selected on solo bus), or exclusive, so that only one solo switch is active at a time ("last pressed"). Any signal being solo'd appears on the dedicated left and right solo meters, and is audible in the stereo headphone system and the Monitor outputs (unless the SOLO OFF button is pressed). Solo functions may be canceled by tapping any illuminated solo switch, or all solo switches may simultaneously be canceled using the Solo Clear switch.

Solo Control

This covers the Solo Control features located in the Master section

post fader switch

Any input or output signal that is solo'd can be derived before or after it's main level control. In the case of Input channels this would be the channel fader and in the case of outputs this would be the output fader or rotary pot.

- Pre fader - Any input or output signal that is solo'd will be derived before it's main level control.
- Post fader - Any input or output signal that is solo'd will be derived after it's main level control.

additive / last press pressed switch

The solo system has two modes - ADDITIVE and LAST PRESSED.

- Additive - Multiple inputs/outputs can be solo'd at once. After soloing one input or output, pressing subsequent channel solo switches will continue to add channels to the solo bus. Pressing any solo button that is already activated will deactivate that solo.
- Last Pressed - Only one solo can be activated at a time. Pressing another solo button will clear the previous solo.

solo active / clear switch

- This momentary, illuminated switch provides two functions.
 1. Solo active - When any input/output on the console is solo'd, this switch it lit up.
 2. Clear - Pressing this switch will clear (shut off) any inputs/outputs on the console that are solo'd. This is especially useful when the solo system is in Additive mode, to clear multiple solos with one button press.

5 master control section

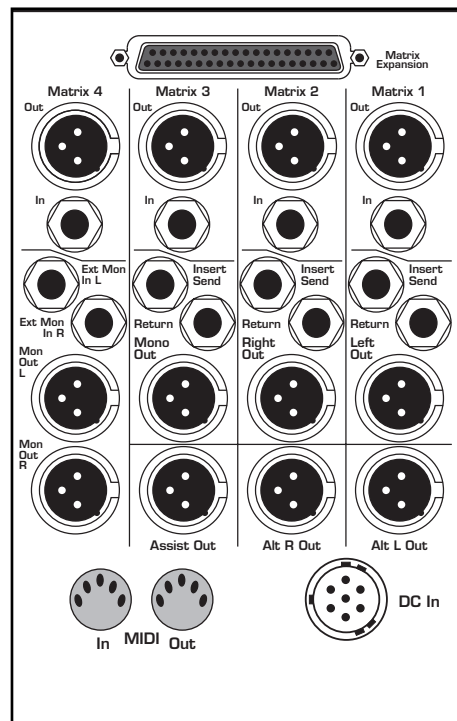
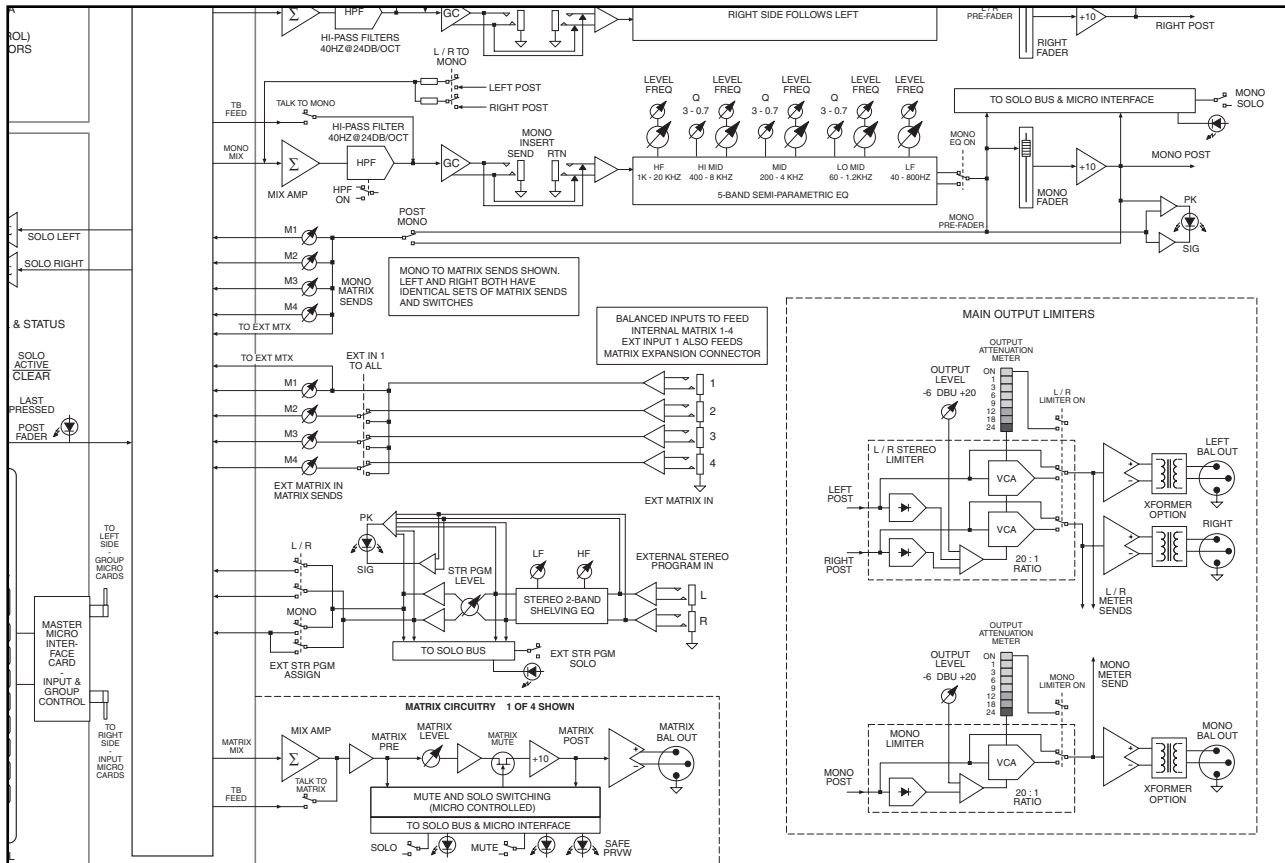

rear panel features

matrix expansion

The X-VCA offers a matrix expansion system. In addition to the four matrix outputs available withing the console, the individual matrix feeds can be brought out of the console and fed into an external matrix mixer, produced by Crest. This matrix mixer is the X-Matrix, a single rack space unit that provides two additional matrix mixes. Multiple X-Matrix units can be dasy-chained together for any number of additional matrix mixes. For more information see the section on X-Matrix.

matrix expansion connector

A 37-pin D-Sub connector makes all of the matrix feeds available on the rear panel. These signals can be fed to the Crest Audio X-Matrix unit, any other Matrix mixer, or stand alone mixing board. Feeding these signals to a mixer other than the X-Matrix requires a custom-terminated multi-pin cable that mates to this connector.

The following feeds are available from the Matrix expansion connector:

1. Audio groups, 1 through 8
2. Left, Right and Mono masters
3. External Matrix In #1
3. Talk back audio signal
4. Solo audio signals
5. Solo control signal
6. Power feed, specifically configured to run X-Matrix units.

*All of the audio signals are balanced.

*The Matrix Pre/post buttons on the Groups and L/R/M masters apply to these feeds, as well.

Matrix output connectors (1 through 4)



These balanced male XLR connectors carry the Matrix master outputs 1 through 4.

Matrix external input connectors (1 through 4)

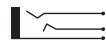

These balanced TRS connectors allow external line level signals to be added to the four Matrix busses. Their levels are controlled by the Matrix send pots located in the master section. A signal fed into External Matrix 1 also gets routed (after it's level control) to the Matrix expansion connector.

5 master control section

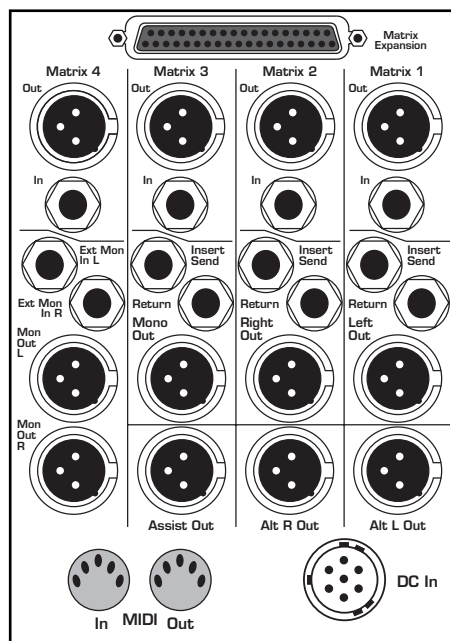
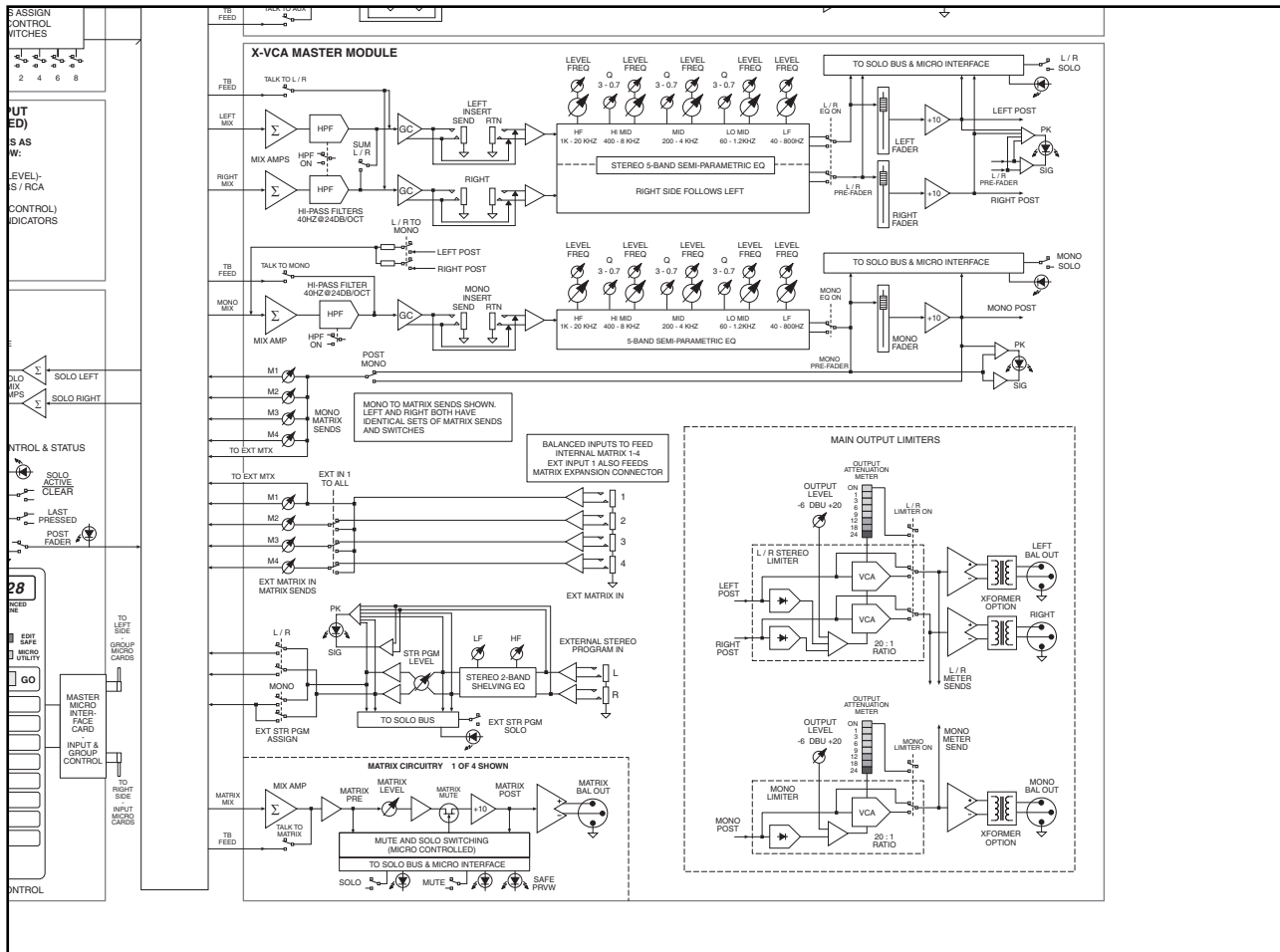

rear panel features

Left, Right and Mono insert points

Separate send and return 1/4" TRS jacks are provided for inserting external signal processors into the Left, Right and Mono outputs. The insert points are located after the Low pass filters and before the EQ sections.

insert send

 This jack serves as an output which gets patched to the input of a signal processor. Plugging a 1/4" TRS plug into this jack does not break the signal flow of the master output. This output jack is ground-compensated.

insert return

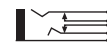
 The output of a signal processor is patched to jack. It can accept a balanced or unbalanced signal. Plugging a 1/4" TRS plug into this jack breaks the signal flow of the master output.

Stereo Program In jacks (left and right)

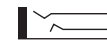
 These two (left and right) 1/4" TRS jacks are used to bring balanced or unbalanced stereo signals into the Stereo Program In section. Typically, they can be the return from a stereo signal processor or the output of a two track playback device.

Left, Right and Mono master outputs

 These three balanced male XLR connectors carry the Left, Right and Mono outputs.

Monitor outputs (left and right)

 These two balanced male XLR connectors carry the Left and Right Monitor outputs 4.

Assist output

 This balanced male XLR connector carries a signal that is made up of the post fader Left and Right master outputs, summed together. Pressing the LCR to Outputs button will add the Mono master output to this summed signal. Internal jumpers can be set to make the master feeds pre fader instead of post fader.

Midi IN and OUT

These jacks allow the microprocessor system to communicate with MIDI gear. See the section on the Microprocessor for more information.

DC In

This 7 pin connector is used to connect the power supply interconnect cable to the console.

6 microprocessor control

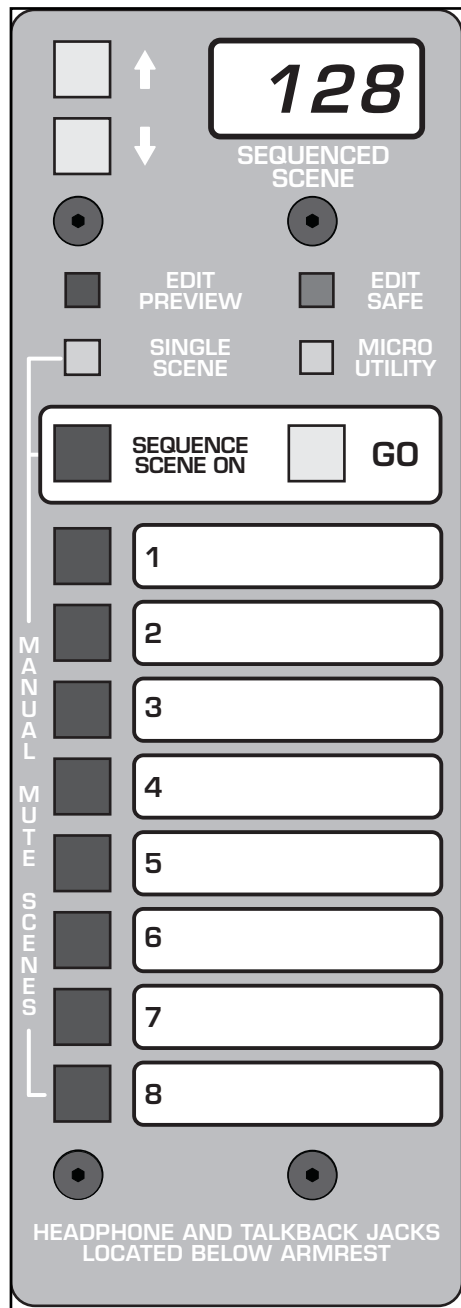

microprocessor controlled muting

The Crest X-Series of Consoles* is equipped with a micro-controlled Mute Controller which permits the user to set-up a series of Mute Scenes, each controlling any combination of channels and outputs. These Scenes can then be recalled, either singly or in combination, to allow the operator to easily control the mutes during a performance.

The Mute Controller features 128 Sequenced Scenes (Patches) along with 8 Manual Mute Scenes. The 128 Patches can be stepped through using a single button, or remotely activated by the use of MIDI patch-change commands. The Patches can be combined with the Manual Scenes to allow different combinations of Channel mutes.

The following is a overview of the controls and indicators of the Mute Controller and the Channels (see diagrams on previous page). The following information pertains to X-Eight consoles with Rev 1.12 firmware, and X-Monitor consoles with Rev 1.00 firmware.

12-12-01 Supplementary information....□

□

- 1) To perform "FULL FACTORY RESET" of Micro Mute and VCA □ settings hold up/down buttons upon power-up. This will clear all □ memory and restore Micro Controller to factory presets.
- 2) Do not use the "uP" parameter with the setting "OFF" in the utility □ menu until a newer EPROM version is released. Please submit your □ console serial # and shipping address to Roffi@CrestAudio.com if □ you wish to be on an EPROM distribution list for this event.□
- 3) EOF stands for Edit On the Fly. A new parameter offered in the □ utility menu. When selected it allows for spontaneous removal of a □ mute you have programmed in as part of a current scene.□

6 microprocessor control

mute control panel

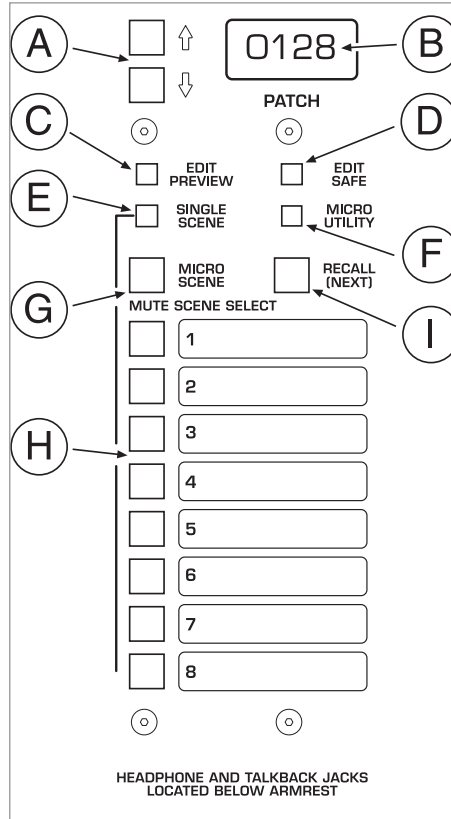

typical input or output

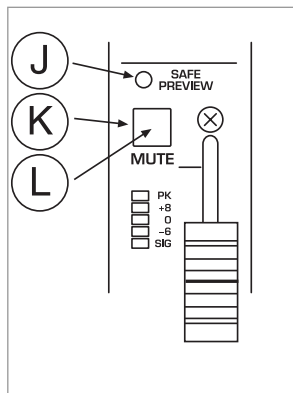

Mute controller

A)Up/Down

Each press of these switches increments or decrements the Patch Display (B). Holding either button down will allow quickly scrolling up or down. The buttons are also used to select the parameters and settings of the system while in Utility mode.

B)Display

This 4-character alpha-numeric display normally shows the current Patch (1 through 128) being recalled. It is also used to display the parameters and settings of the system while in Utility mode.

C)Edit Preview

Pressing this switch puts the system into Edit/Preview mode, allowing the operator to view and change the contents of any selected Mute Scene. The internal red LED will blink while in this mode, along with the status LEDs (J) of any channels assigned to the selected Mute Scene. Pressing a Channel Mute Sw (K) will add or remove a channel from that Scene. Pressing the Edit/Preview switch again will exit back to normal operating mode.

D)Edit Safe

Pressing this switch puts the system into Edit Safe mode, allowing the operator to view and change the contents of the SAFE memory. The internal green LED will blink while in this mode, along with any channels assigned to the Safe Scene. Pressing a Channel Mute Sw (K) will add or remove a channel from the Safe Scene. If a channel is included in the Safe Scene, it can't be muted from a Mute Scene. This allows the operator to remove a channel all Scenes without having to edit any of the Scenes themselves. Pressing the Edit Safe switch again will exit back to normal operating mode.

E)Single Scene

There are 9 mute sources available from the Mute Controller: the 8 Manual Mute Scenes (H), and the Micro Scene (G). Normally any or all of these 9 sources can be active at one time, which allows the operator to combine different mute patterns. The Single Scene switch, when depressed, permits only 1 of the 9 sources to be active at one time.

F)Micro Utility

This latching switch will put the system into Utility mode. The operator can then access and view the various parameters and functions of the controller using the Up/Down buttons (A) and the Display (B).

G)Micro Scene

This switch activates the Sequenced Scene (Patch). The display (B) shows which of the 128 possible Scenes are active.

H)Manual Mutes

These 8 switches activate the associated Manual Mute Scene. Additionally, these switches, along with (G), select which Mute Scene is being edited when in Edit Preview Mode.

mute control panel

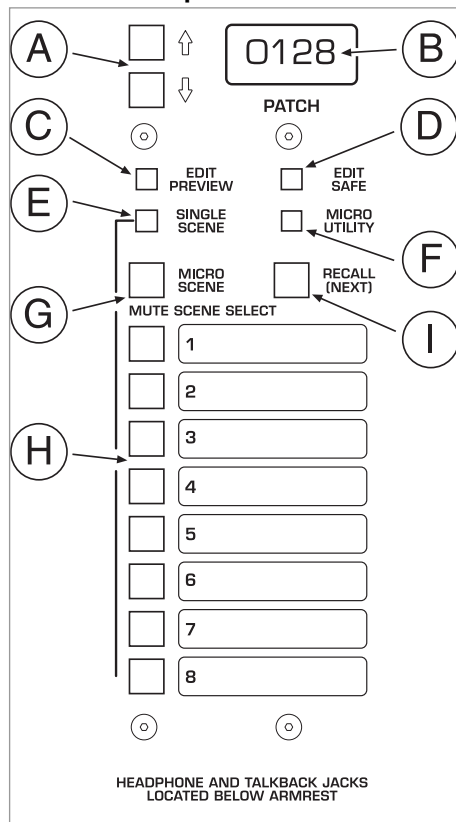

typical input or output

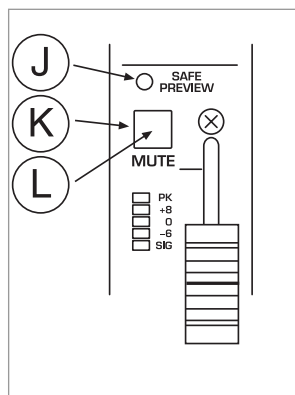

Mute controller

I) Recall (Next)

Each press of this switch increments the Sequenced Mutes by one, the display (B) will reflect this. Also used to activate the displayed Scene when an Up/Down (A) button was used to scroll to a new Scene. In this case, an "*" will be displayed as the first character in the display to indicate that the displayed number is not currently the active Scene. Pressing Recall will put that displayed Scene into place and clear the "*" from the display.

NOTE: All of the above actions will take place, but the displayed Sequenced Scene will not be active (mutes not enabled) unless the Micro Scene switch (G) is lit. Each press of these switches increments or decrements the Patch Display (B). Holding either button down will allow quickly scrolling up or down. The buttons are also used to select the parameters and settings of the system while in Utility mode.

mute control panel

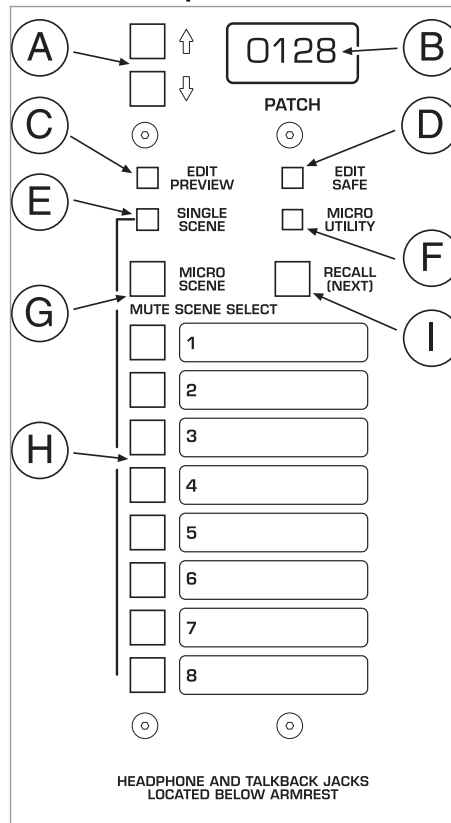

typical input or output

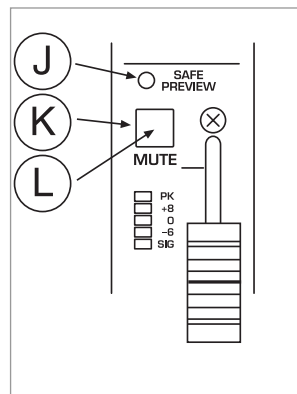

channel mute controls

J) Status LED

This bi-color LED, associated with each controlled Mute, shows the condition of that mute. One of 5 possible states is possible:

- 1) Off- The channel is not controlled by the Mute Controller.
- 2) Steady Red- The channel is being muted by a Mute Scene.
- 3) Steady Green- The channel is in Safe Mode, can't be muted by any Scene.
- 4) Blink Red- The system is in Edit Preview Mode and the channel is in the currently selected Scene (only 1 Scene active at a time).
- 5) Blink Green- The system is in Edit Safe Mode and the channel is included in the Safe Scene.

K) Mute Switch

This momentary switch toggles the Channel's local mute and is also used to assign / un-assign channels to Mute and Safe Scenes when in the Edit Modes.

L) Mute LED

This internal Red LED will illuminate whenever the channel is muted, either locally or by a Mute Scene.

NOTE: If a channel is already locally muted when a relevant Mute Scene is activated, this LED will remain lit. 2 sources are now telling the channel to mute; the Local Mute and the Mute Scene. If the Mute Sw (K) is pressed once, the local mute will be cleared, but no apparent change will occur. The Mute LED (L) will still be lit, and the Status LED (J) will still be steady Red. At this point there is only one source telling the channel to mute; the Mute Scene. If the Mute Scene is then disabled, the channel will un-mute because the Local Mute was previously cleared. The user should be aware of this fact: The Local Mutes can toggle invisibly behind a Mute Scene. For an even number of presses on the Mute Sw (K), the Local Mute will return to its original state, an odd number of presses will change the Local Mute to its opposite state. Each press of this switch increments the Sequenced Mutes by one, the display (B) will reflect this. Also used to activate the displayed Scene when an Up/Down (A) button was used to scroll to a new Scene. In this case, an "*" will be displayed as the first character in the display to indicate that the displayed number is not currently the active Scene. Pressing Recall will put that displayed Scene into place and clear the "*" from the display.

NOTE: All of the above actions will take place, but the displayed Sequenced Scene will not be active (mutes not enabled) unless the Micro Scene switch (G) is lit. Each press of these switches increments or decrements the Patch Display (B). Holding either button down will allow quickly scrolling up or down. The buttons are also used to select the parameters and settings of the system while in Utility mode.

mute control panel

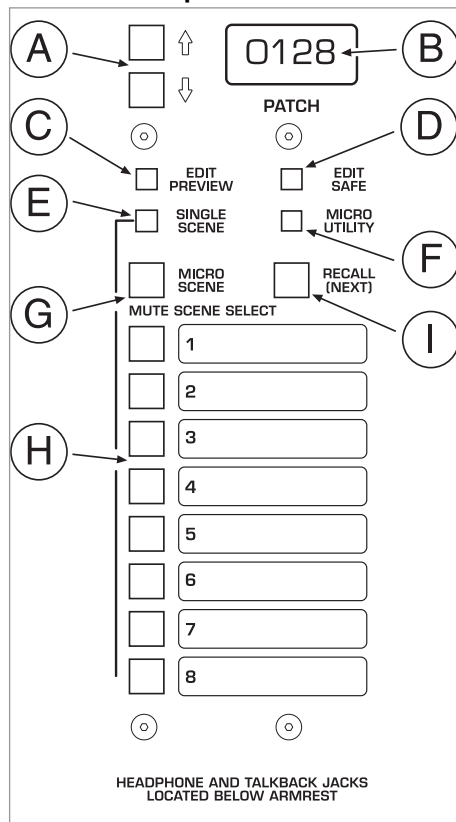

typical input or output

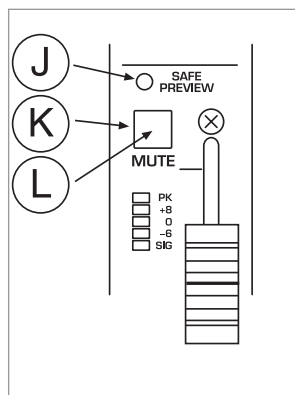

mute scenes

There are 9 possible Scene sources: Manual Mute Scenes 1 thru 8, and the Micro Scene. The Micro Scene button (G) is the enable switch for the 128 possible Sequenced Scenes. The 8 Manual Mutes are totally independent of the 128 Sequenced Scenes, giving the system a total of 136 possible mute patterns. Each of the 136 patterns can consist of any combination of Channel and Output mutes, all of the 9 possible sources can be combined to create additional patterns.

Creating a Mute Scene (or Editing an existing one):

1) Press the Edit Preview button (C), it will begin to blink, indicating that the system is in Edit Preview Mode.

2) Select a Scene to Edit: The system will automatically choose a Scene to edit, depending on the status of the system when Edit Preview was selected. If the system was in Single Scene Mode (switch E depressed), the Mute Scene that was currently active will be selected to edit. If the system was in Multiple Scene Mode (switch E not depressed), the Micro Scene will be automatically selected for editing. If a different Scene than the default is to be edited, that scene should now be chosen by pressing 1 of the 9 possible Mute Scene buttons (G & H), it will illuminate to show its selection. Only one scene can be selected for editing, the condition of the Single Scene button (E) has no effect in Edit mode.

3) If Micro Scene is selected: If Micro Scene (G) was selected, then the Up/Down (A) buttons should be used to select the desired Sequenced Scene (Patch) to be edited. The Display (B) will indicate which of the 128 possible patches is being worked on. Note: When returning to Normal Mode, the system will revert back to the Patch that was in place before entering Edit Mode.

4) Assign channels to the Scene: Any channels currently assigned to the Scene being edited will have their Status LEDs (J) blinking Red. Pressing the associated Mute Sw (K) will assign / de-assign that channel to the Scene.

5) Clearing a Mute Scene: If you wish to clear all assigned channels from a Scene, press and hold the Edit Safe (D) button. After a brief delay, the display will change to CLR?; continue to hold the button down until the display shows CLR.D. All channels assigned to that Scene will be de-assigned and you can start fresh.

6) Saving your edit: Once you have a Scene configured the way you want it, either press the blinking Edit Preview (C) button to exit Edit Mode and return to Normal Mode, or select another Scene to edit by pressing its associated switch (H), or, if Micro Scene was selected, press the Up/Down (A) keys to select a new Patch to edit. There is no STORE button to press, the changes take place immediately while editing, and the Scene is saved automatically when a new Scene is selected or upon exiting Edit mode. NOTE: This immediate change will be most apparent when editing a scene that is currently the active scene (the Mute Scene that was ON when you entered Edit mode). The Mute LED (L) will change along with the Status LED (J) as a channel is added or removed from the scene during editing.

6 microprocessor control

mute control panel

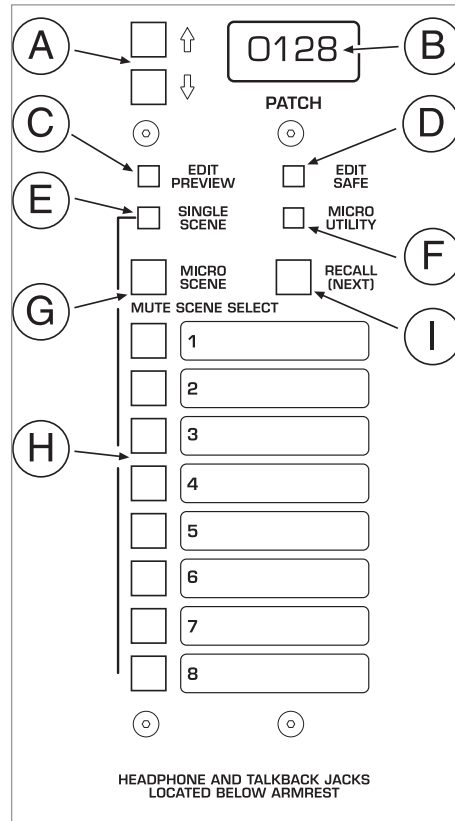

typical input or output

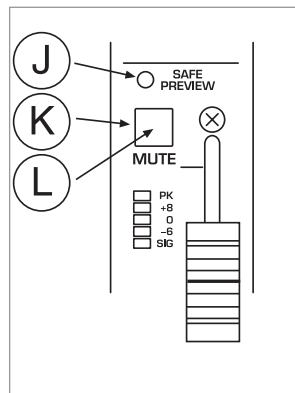

copying a mute scene

Copying a Mute Scene:

Mute Scenes can be copied from a Sequenced Scene (Patch) to a Manual Mute Scene. Manual Mutes cannot be copied to Sequenced Scenes or to each other. To copy a Sequenced Scene into a Manual Mute Scene, follow the steps outlined below.

- 1) Press the Edit Preview button (C), it will begin to blink, indicating that the system is in Edit Preview Mode.
- 2) Select Sequenced Scenes by pressing the Micro Scene (G) button; it will illuminate.
- 3) Scroll to the Scene to be copied using the Up/Down (A) keys to change the Display (B).
- 4) Hold down the Micro Scene button. The display will show "Cpy?".
- 5) Still holding down the Micro Scene button (G), now also press the desired Manual Mute switch (H). The display will show "Copy", and the Sequenced Scene Mute pattern is copied to the target Manual Mute, overwriting whatever pattern may have originally been there.
- 6) You can now select the newly created Manual Mute Scene for editing by pressing its select switch (G). The copied Mute pattern will be there, you can use that as a starting point for your edits.
- 7) Exit back to Normal mode when you're done by pressing Edit Preview (C) again.

NOTE: You can use this copy feature as a way to "Back-up" your Manual Mute Scenes, even though you can't copy from Manual Mutes to any other Mutes. Instead, use the highest numbered Patches (120 to 127) to create the original versions of your Manual Mute Scenes. Then use the copy function to transfer those patterns into the Manual Mutes. You can always go back to the originals (120 to 127) and re-load (copy) them into the Manual Mutes whenever needed. You can also use Patch 128 as an All Mute memory. Program it with all channels muted, you can then copy it to a Manual Mute when you need to start a Scene with all channels muted instead of all channels un-muted (you already have a way to start a Scene with all channels un-muted, you can hold down the Edit Safe button to clear all mutes in a Scene when editing).

mute control panel

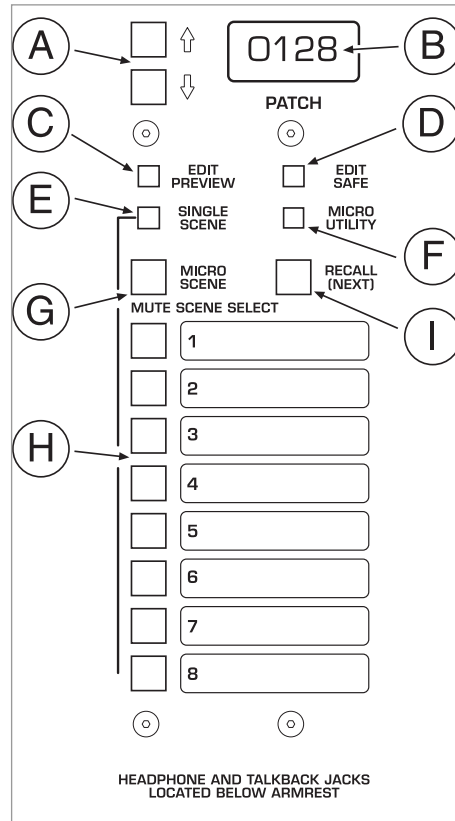

typical input or output

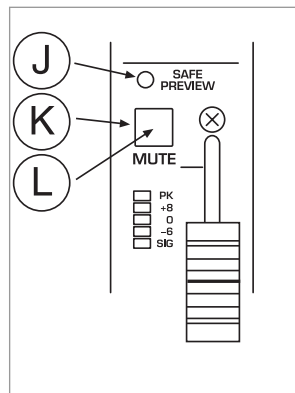

The Safe Scene

There may be occasions when a channel needs to be made "Safe" from all programmed mutes. This may occur during a show when an on-stage microphone needs to be used as an announce mic, or a switch-over has to be made to a backup channel due to some technical difficulty. The Safe Scene allows a channel to be removed from the control of all Mute Scenes without having to edit any of the scenes. Once a channel is assigned to the Safe Scene, it will ignore all Mute Scene commands. The Mute Scenes themselves are not altered, it's only the channel's response that has been changed. This allows temporary changes to be made to a show, due to nightly needs, without having to go in and edit the programmed scenes. You'll probably need the original scenes, as is, the next time the show is performed. NOTE: The Local mute command is not affected by this Safe, the Local mute is always effective. The Safe Scene is always active, if a channel is assigned to the Safe Scene, it will ignore any mute commands from a Mute Scene. The Status LED (J) of a channel will be a steady Green color if a channel is Safe.

Editing the Safe Scene:

- 1) **Enter Edit Safe Mode:** Press the Edit Safe button (D), it will begin to blink, indicating that the system is in Edit Safe Mode.
- 2) **Select a channel to safe:** Pressing the Mute Sw (K) of a channel will assign/de-assign a channel to the Safe Scene. The status LED (J) of any channel assigned to the Safe Scene will blink Green. If a channel is currently muted because of a Mute Scene, assigning it to the Safe Scene will immediately un-mute it.
- 3) **Clearing the Safe Scene:** If you wish to clear all assigned channels from the Safe Scene, press and hold the Edit Preview (C) button. After a second or two, the display will change to CLR?. Continue to hold the button down until the display shows CLR.D. All channels assigned to the Safe Scene will be de-assigned and you can start fresh.
- 4) **Exit Edit Safe Mode:** Press the blinking Edit Safe button (D) again. It will stop blinking and the system will return to Normal mode. Any blinking Green status LEDs will turn to steady Green indicating that the channel is in Safe mode. If a channel was previously being muted by only a Mute Scene (status LED was steady Red), but is now "Safe", the status LED will show steady Green and the Mute LED (L) will be off. If the channel was being muted by a Local mute, it will remain muted. The Safe Scene does not affect Local Mutes.

NOTE: Assigning a channel to the Safe Scene can be done quickly if an emergency arises and a programmed channel has to be un-muted. It's a simple 3 step process:

- 1) Press the Edit Safe Sw to enter Edit Safe mode
- 2) Press the Mute Sw of the desired channel- The channel will un-muted at this point.
- 3) Press the Edit Safe Sw again to return to Normal mode

6 microprocessor control

mute control panel

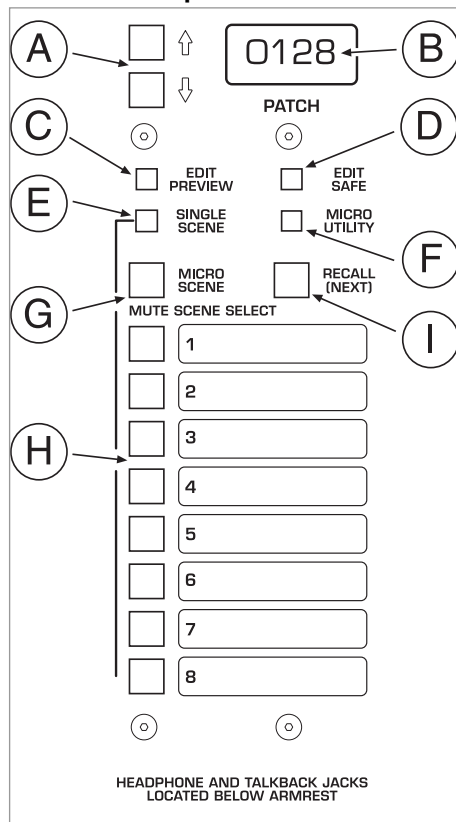

typical input or output

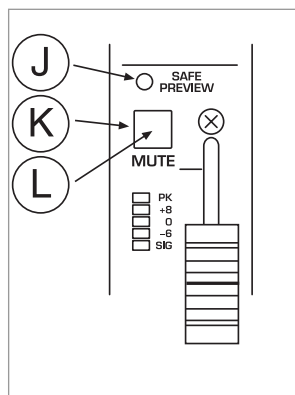

Utilities

The Mute Controller has a number of parameters that the user can change. A Utility Mode is provided for accessing these settings. The following is a current list of parameters, along with their default and other possible settings. The default setting is shown UNDERLINED. An explanation follows on how to review or change the different settings.

<u>Display</u>	<u>Meaning</u>	<u>Settings</u>
uP	Micro Processor	ON or OFF
Determines whether the Mute System is ON or OFF. When OFF, the entire Mute Scene system is disabled, only the Local mutes will operate. This setting can be used if "Traditional" console operation is desired (i.e. No programmed scenes are wanted).		
M Ch	MIDI Channel	01 to 16
Sets the MIDI channel that the Controller uses to communicate to the MIDI world. The Mute Controller can send and receive MIDI Program changes, MIDI dumps etc. It does so on this channel.		
Lock	Edit Lock	OFF or ON
If set to ON, prevents any changes to be made to any Mute Scene. If Edit Preview is pressed when LOCK is ON, "Lock" is displayed and the system will not enter Edit Mode.		
Dmp?	MIDI Dump	
When activated, the contents of all the Mute Scenes are transmitted via the MIDI Out jack using SysEx protocol. A librarian or archiving MIDI program can be used to store the Mute settings externally. Note: Loading of external data via SysEx command is always active.		
Base	MIDI Base	01 or 00
There are 128 possible MIDI numbers. Do you want to start counting at 01 and count up to 128, or start at 00 and count up to 127 ? Different MIDI devices do it either way. You get to choose.		
Ext	External Ctrl	OFF or ON
Normally, the Mute System uses its internal Mute Scenes to control the Console mutes. Alternately, MIDI Note Commands can be used to control the channel mutes directly. When Ext is ON, the Display(B) will show "Ext", and the normal Mute Scenes will be disabled. The Controller will now respond only to externally received Note On/Off commands (via MIDI In jack).		
Pgm	Program Chg	ON or OFF
The Mute Controller normally sends a MIDI Program change command every time the RECALL (I) button is pressed, corresponding to the Patch number shown in the Display. Also, if a MIDI Pgm Chg is received, the Controller will respond by recalling the Patch Mute matching that Pgm Chng. Setting Pgm to OFF disables the sending and receiving of MIDI Pgm Changes.		

6 microprocessor control

mute control panel

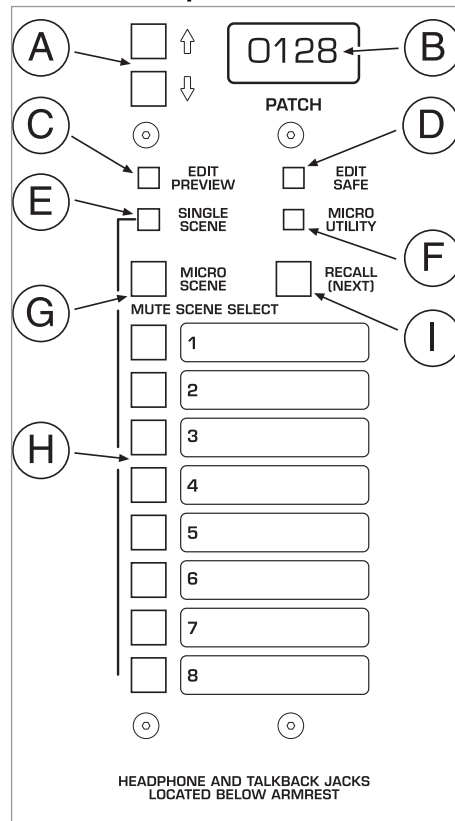

typical input or output

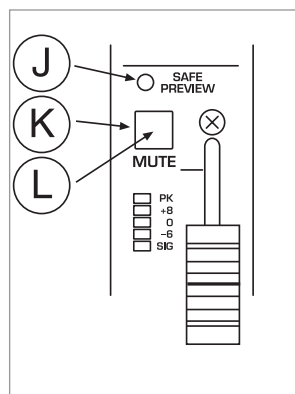

Changing and reviewing the utility changes

The Utility settings can be accessed by entering Utility Mode. Once there, the different parameters can be changed to suit user's preferences. The changes stay in effect until they are again modified by the user, or a System Reset is performed (detailed later) which changes them all back to their default settings.

Utility Mode:

- 1) **Enter Utility Mode:** Press the Micro Utility button (F), it is a latching switch, and the system will stay in Utility Mode while this button is depressed. The Display (B) now shows the first Parameter - " uP " of the Parameter List.
- 2) **Select a Parameter to edit:** Use the Up/Down keys (A) to scroll thru the list of available Parameters.
- 3) **View the current Setting:** Press the Recall (I) button. The Display will change from showing the Parameter to showing the Parameters current setting.
- 4) **Changing the setting:** While the Display is showing Parameter Settings (not the Parameter itself), the Up/Down keys will scroll thru the list of possible settings for that Parameter. Use the keys to select the new setting and press the Recall button again. The Display will briefly show " **** ", the displayed setting will be activated and the Display will go back to showing the Parameter. Note: The only way to get back to showing the Parameter is to press the Recall button, so even if no change is desired, the Recall button must be pressed. **Make sure the display is showing the desired setting when you press Recall.** You are now back at Step 2, and can continue to select and change Parameters.
- 5) **Exit Utility Mode:** Once you're done, press and release the Micro Utility (F) key, the Mute System returns to Normal Mode with the new settings in place.

7 vca facilities

Inputs and outputs

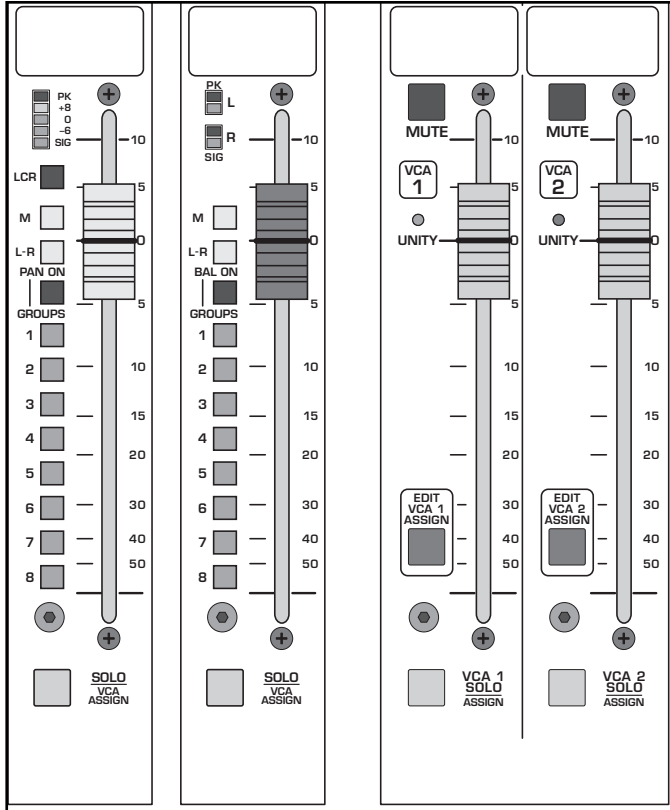

micro control panel

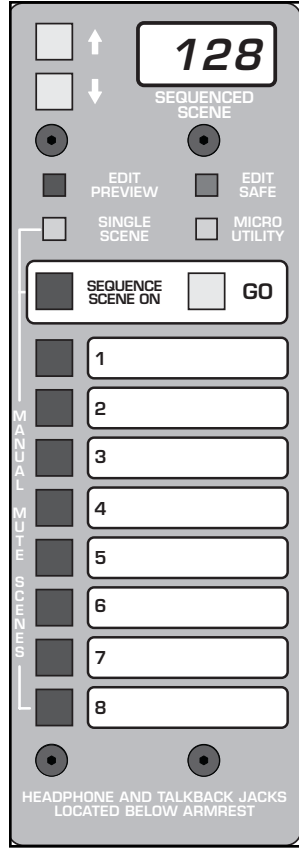

X-VCA operation - overview

In addition to Mute scenes, the X-VCA Micro also controls the VCA assignment for each Channel. A Channel on an X-VCA refers to either an Input channel (up to 52 possible positions, depending on Console size), or an Audio Group (Total of 8). Unlike traditional VCA Consoles where the VCA assignment is done with fixed switches, the assignment for the X-VCA is done through the on-board Microprocessor. This allows the X-VCA to have up to 128 different VCA Assignments if need be. There is a Scene-0 default setting, which is normally active, or the Console can be switched so that the VCA assignment follows the current Scene. Using the Recall button on the Micro Panel, the user not only can step through 128 possible Mute Scenes, but can also change the VCA assignment on a Scene-per-Scene basis.

The SOLO switches and LEDs are called upon to do double duty in the X-VCA; in addition to their normal SOLO functions, they are also used to program the VCA assignments. When used for programming the VCAs, the SOLO function is disabled, or canceled if already active. Normal SOLO functions return after VCA assignment is done, but the prior state of the SOLO is not restored

Inputs and outputs

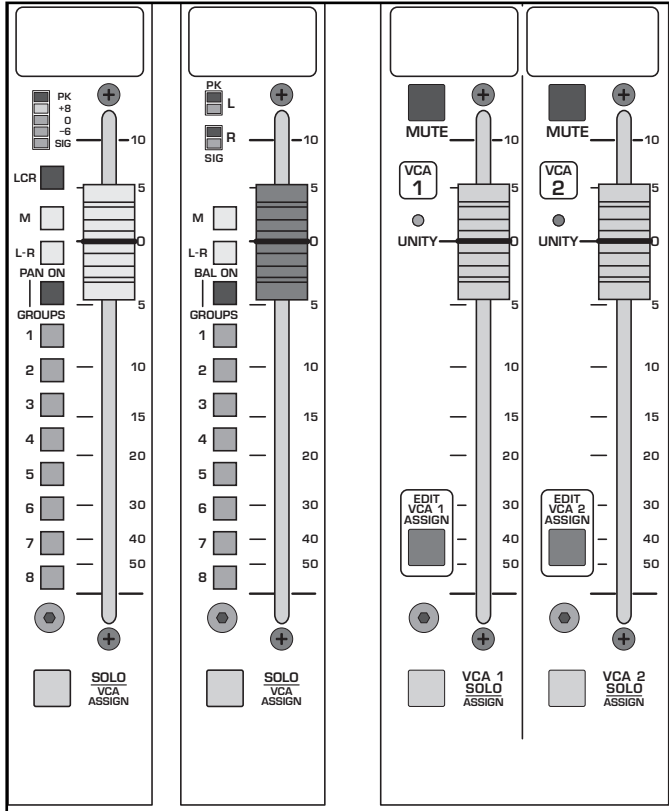

micro control panel

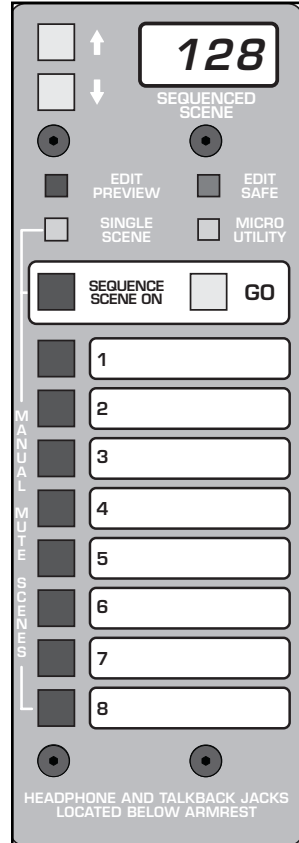

VCA assigning - overview

There are two methods available for assigning Channels to the 8 VCA Masters; the first method views the assignment from the Channel's perspective, the second method looks at assignment from the VCA Master's point of view. The word "Channel" in this case refers to any of the Mono or Stereo Input modules, or any of the 8 Audio Groups. Both methods are referred to as VCA Assignment in this text, and both use the SOLO switches and LEDs of the Channels and Masters to implement the function. When entering VCA Edit Mode via either method, the normal SOLO functions of the Console are disabled. If a Solo is active when entering this mode, it is cleared. When exiting from VCA Edit Mode, normal Solo functions return, but the state of the earlier Solo is not restored.

NOTE: The VCA Assignment is performed the same way regardless of whether the assignment is to the default Scene-0, or to any of the 128 other Scenes. The VCA-Follow-Scene switch, along with the Scene # display, determine which of the 129 possible VCA assignments is being affected. (Scene-0 or Scene 1 thru 128).

Method 1- Channel to Master Assignment:

In this first method, the assignment is done on a Channel by Channel basis. The Console is put into VCA Edit Mode by pressing the single EDIT-CHAN-VCA-ASN switch, located near the Mono fader; it begins to blink. Any one Channel can then be selected by pressing its Solo switch; it also begins blinking. That Channel's VCA assignment will be indicated on the 8 Master VCA Solo switches, any Master VCA that the Channel is assigned to will have its Solo LED now blinking. The User can change the assignment by pressing any of the Master VCA Solo switches, it will toggle state. When satisfied with that Channel's assignment, the User can select another Channel to view/edit by pressing a new Chan Solo Switch, or can exit from VCA Edit Mode by re-pressing the EDIT-CHAN-VCA-ASN switch. Note: If the EDIT-CHAN-VCA-ASN switch is held down for 2 seconds or more, the selected Channel's assignment to all the VCA Masters (for that Scene only) will be cleared (un-assigned). This Clear function gives the User a fresh starting point for assignments. If a Channel is not selected, pressing the Edit Chan VCA Sw will cause an exit back to Normal Operating Mode when it is released.

Method 2- Master to Channel Assignment:

In this second method, the Assignment is done on a Master by Master basis. The Console is put into VCA Edit Mode by pressing any one of the 8 EDIT-VCA#-ASSIGN switches; it begins to blink. ALL Channels assigned to that Master VCA for that Scene will indicate assignment by their SOLO LEDs blinking. The User can toggle a Channel's assignment to that Master by pressing the Channel's Solo switch. When satisfied with that Master's assignment, the User can select another Master to view/edit by pressing its EDIT-VCA#-ASSIGN switch, or can exit from VCA Assign Mode by re-pressing the original EDIT-VCA#-ASSIGN switch.

Note: If the active EDIT-VCA#-ASSIGN switch is held down for 2 seconds or more, all Channels assigned to that VCA Master (for that Scene only) will be un-assigned. This Clear function gives the User a fresh starting point for assignments.

NOTE: VCA Edits are performed LIVE. When entering either VCA Edit Mode, the selected Scene's data for VCA Assignments and Mutes is immediately made active on the Console and the Channels will respond to any changes made during the Edit. The Assignment and Mute data that was active while in Normal Operate Mode is replaced with the Edit Data upon entering VCA Edit Mode and then restored to Normal upon exiting from VCA Edit.

7 vca facilities

Inputs and outputs

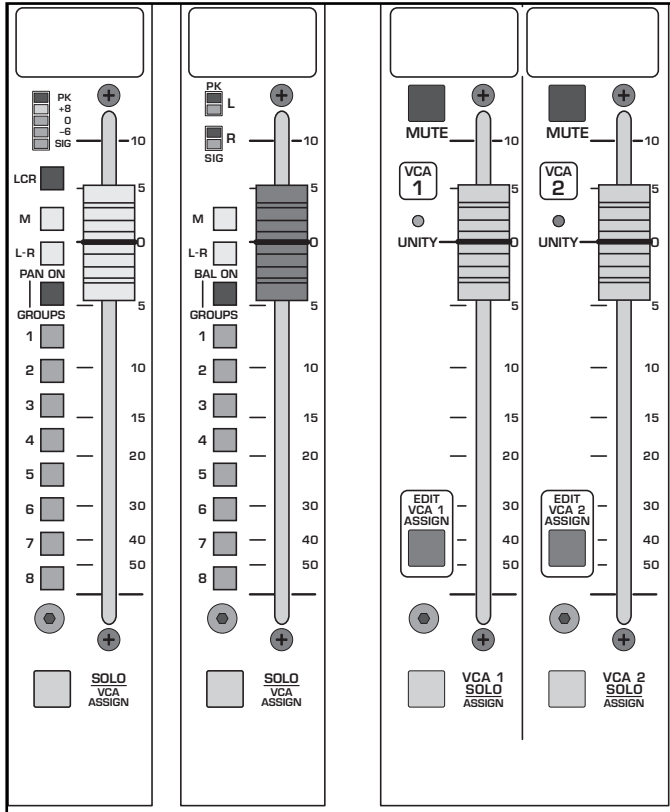

micro control panel

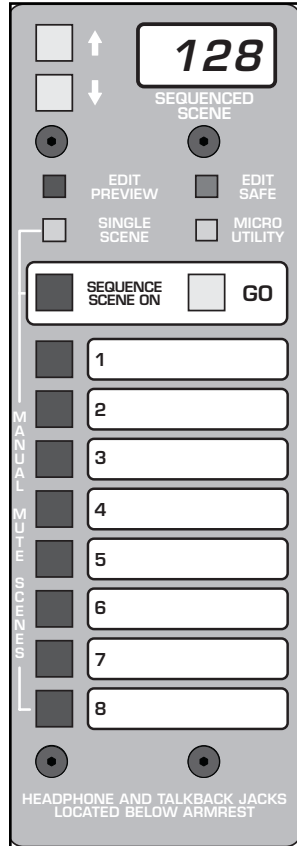

VCA assigning - overview

VCA Assignment- Scene-to-Scene changes:

When operating the X-VCA in VFS Mode, up to 128 different VCA assignments are possible. Each Channel can be re-assigned to different VCA Masters with each Scene change. This can be most useful for theatrical performances where the Console operator is juggling many different audio sources during a show and a different performer takes the lead position depending on the particular Scene. During one scene, the lead performer is the artist on Channel 1, in the next Scene, the artist on Channel 5 now has the lead, and so on. This is not restricted to only the vocalists; the orchestra may also feature different lead players during different Scenes. By allowing the Channels to be reassigned to different VCA Masters, the operator can arrange the assignments so that the lead performer is always controlled by the same VCA Master. In the example above, during Scene 1, Chan 1 is assigned to VCA Master 1. We'll call this our "Lead Vocal VCA". For the next scene, the lead changes to the performer on Channel 5. For this Scene, Channel 5 is assigned to VCA Master 1 and Chan 1 is assigned to VCA Master 2 (Bkgnd Vocs). Instead of having to remember during a show to switch his attention to a different faders depending on the Scene, the operator can set up the assignments during rehearsal so that the lead vocalist is always assigned to VCA Master 1. During the performance, the operator knows that the lead vocalist (whomever that may be) is always on VCA Master 1, so he can concentrate of mixing instead of trying to remember which fader he has to move. This same functionality can be extended to lead instruments, background players, chorus, etc.

Although 128 different VCA assignments are possible, only the relevant Scenes need to be programmed. If, for example, there are assignment changes needed during Scenes 1, 5, 12 and 23, only those particular Scenes need to be edited. The Scenes in-between the changing Scenes take on the previous Scene's assignment and don't have to be specifically programmed. In the above example, Scenes 2 thru 4 have the same assignments as Scene 1, Scenes 6 thru 11 are the same as Scene 5, etc. If a Scene is edited, that edited assignment now carries through until the next edited Scene is encountered in the list. Again using the above example, if a change is made at Scene 9, that new assignment will also be in place for Scenes 10 and 11 before changing to the new assignment previously set up at Scene 12. This allows the operator to quickly set up VCA assignments without having to concern himself with Scenes that don't need his attention. VCA assignments can also be copied across different Scenes. This allows the operator to use a common scene as the basis for many other scenes. Common starting assignments can be safely stored at the higher Scene numbers (120-128), it's unlikely that you will need to access numbers that high in a typical show. Using the COPY function, the operator can Copy the Starting Scene assignment from Scene 120, and then paste it into whichever Scene number is appropriate for the show. The newly pasted scene can then be edited to its final form.

7 vca facilities

Inputs and outputs

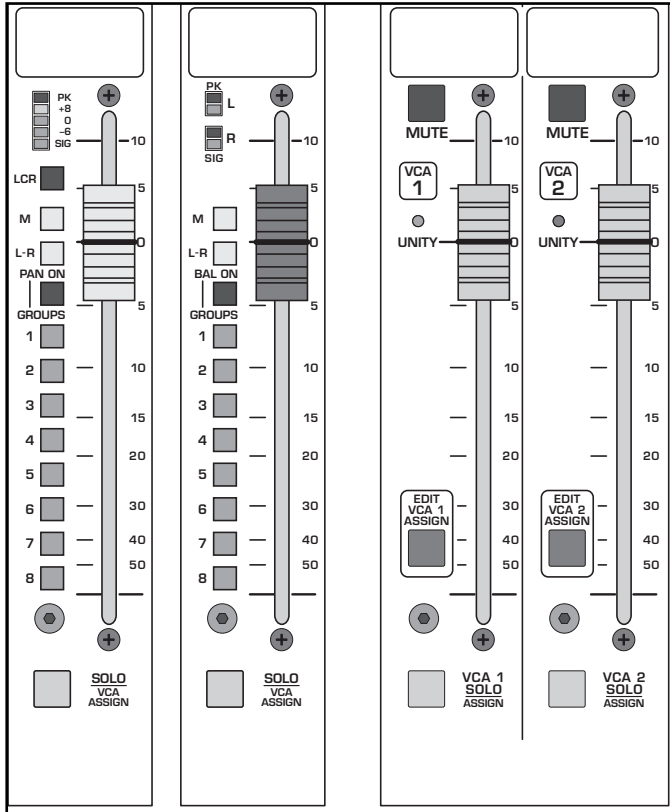

micro control panel

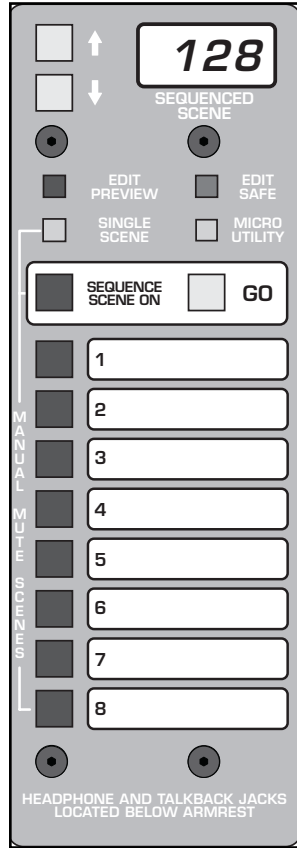

VCA assignment 1 - detailed operation

Note: Front Panel Switches are indicated by BOLD-HYPHENATED-CAPITALIZED-TEXT. For the 8 VCA Masters, the switch to select the Master for assignment is indicated by "VCA-#-SOLO", # represents a number 1 thru 8. There are two methods for doing VCA Assignment on the X-VCA.

This first method assigns Channels to Masters:

One of the Channels (any Input, or one of the 8 Audio Groups) is selected and its assignment to all of the 8 Masters can be viewed at a glance. Changes can be made as needed, and then a new Channel selected for editing. Or, the same Channel can remain selected and the Scene can change (using the Scroll Buttons). For this to occur, the VFS switch must be down. If the VFS switch is not depressed, the assignment changes are only affecting Scene-0, the display will have no bearing on the VCA data. VCA Safe is also implemented in this Mode.

VCA Assignment- Channel to Masters:

1. Starting with the Console in NOM Mode, the EDIT-CHAN-VCA-ASN switch is pressed.
2. Any Solos that were active are cancelled, the Console SOLO system is disabled. The Safe/Preview bi-color LEDs on the Channels will switch-over from showing Mute conditions (RED=Muted, Green =Mute Safe), to showing VCA Safe (Steady Green=VCA Safe).
3. The EDIT-CHAN-VCA-ASN sw begins to blink, indicating that the Console is in VEM Mode.
4. The user must then select a Channel to edit by pressing the desired Channel's SOLO switch. Only relevant Channel SOLO switches can be selected at this point, any non-VCA related Solos are ignored.
5. That Channel's SOLO LED then begins to also blink indicating its selection.
6. The VCA Assignment and Mute data for this Edit will become active, replacing the prior, Normal Data.
7. Any VCA Master that this Channel is assigned to (for this Scene) will now have its SOLO LED also blinking.
8. The user can then view the Channel's assignment by observing the blinking LEDs of the VCA Master Solo switches.
9. The User can Clear the selected Channel's assignment to any of the Masters (for this Scene) by pressing and holding down the blinking EDIT-CHAN-VCA-ASN switch for 2 seconds.
10. The assignment can be Changed by pressing any of the VCA-SOLO switches located below the Master VCA faders. The LED will change state, immediately assigning or de-assigning that Channel to that Master.
11. The next Channel to be viewed can now be selected by pressing its SOLO switch- Go to step 4 OR- the same Channel can remain selected and the next Scene assignment viewed- IF in VFS Mode.
12. Use the Scroll Up/Down arrows to select another Scene to view.
13. The user scrolls to the desired Scene and changes the assignment as in Step 7.
14. To exit VEM Mode, the original EDIT-CHAN-VCA-ASN switch is pressed again. It stops blinking, the Console returns to NOM Mode and the original Scene data is restored-OR- The user can press one of the 8 EDIT-VCA-ASSIGN buttons and jump directly into VCA Assignment Method -2 (see next page)

7 vca facilities

Inputs and outputs

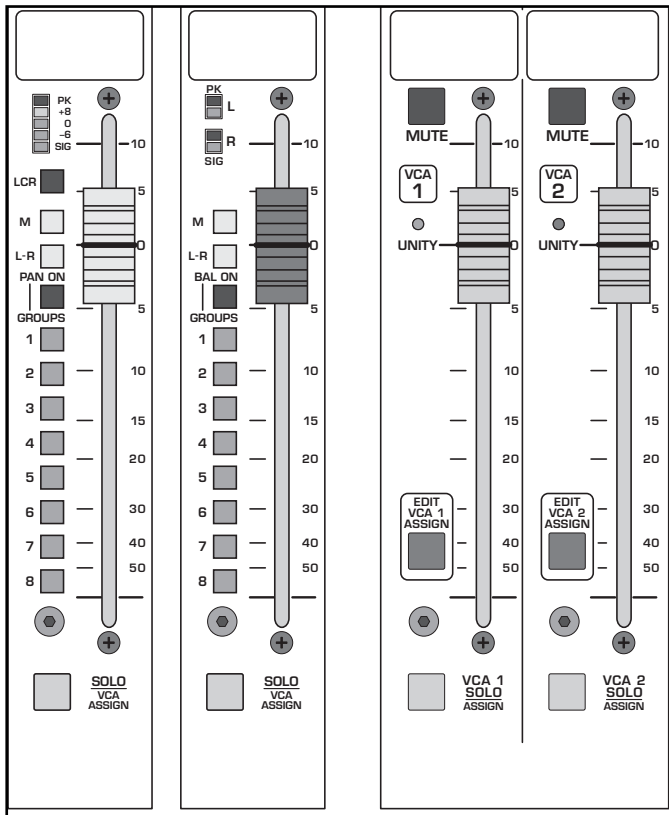

micro control panel

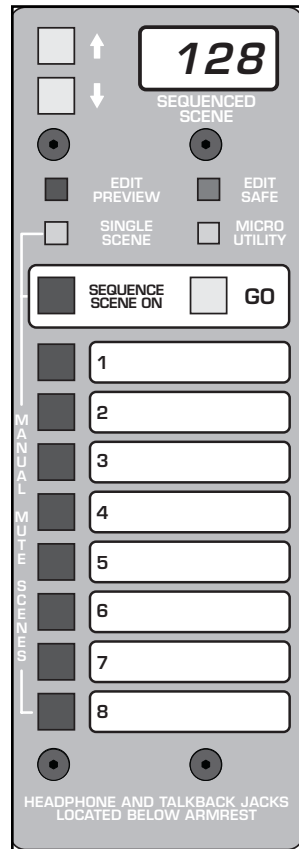

VCA Safe Mode

The user can choose to "SAFE" a Channel from ALL its VCA Assignments while in either VCA Edit Mode. This doesn't actually change any of the assignments in memory, it only isolates the selected Channel from the effects of the assignment- only the Local Fader will have control over the Channel VCA once SAFED, the VCA Mute will also have no effect on the Channel. This is similar to the Mute Safe condition, where a Channel will ignore any Mute patterns it's assigned to without having to actually change the Mute Patterns. There is only 1 setting for all VCA-Safe data.

VCA Safes can be edited while in either VCA Edit Mode:

The Channel Safe/Preview bi-color LEDs will indicate VCA Safe while in VEM Mode. Any Channel that is VCA safed will have its Safe/Preview LED lit steady green. Any Channel that is not VCA Safe will have the LED turned OFF. All other Safe/Preview LEDs associated with other Programmed mutes (Aux and Matrix masters) will be OFF. Those LEDs have no function in this VEM Mode.

To change a Channel's VCA Safe status, press it's associated MUTE switch. The MUTE switch itself will be lit if the Channel is muted, or un-lit if unmuted, pressing it will not affect the status of that switch or the Mute, it will only toggle the state of the VCA Safe.

To clear all the VCA Safes, use the Edit Safe button on the Micro Panel. Press and hold it down for at least 2 seconds, all VCA Safes will be cleared. Note: There is no warning that this Clear will occur.

7 vca facilities

Inputs and outputs

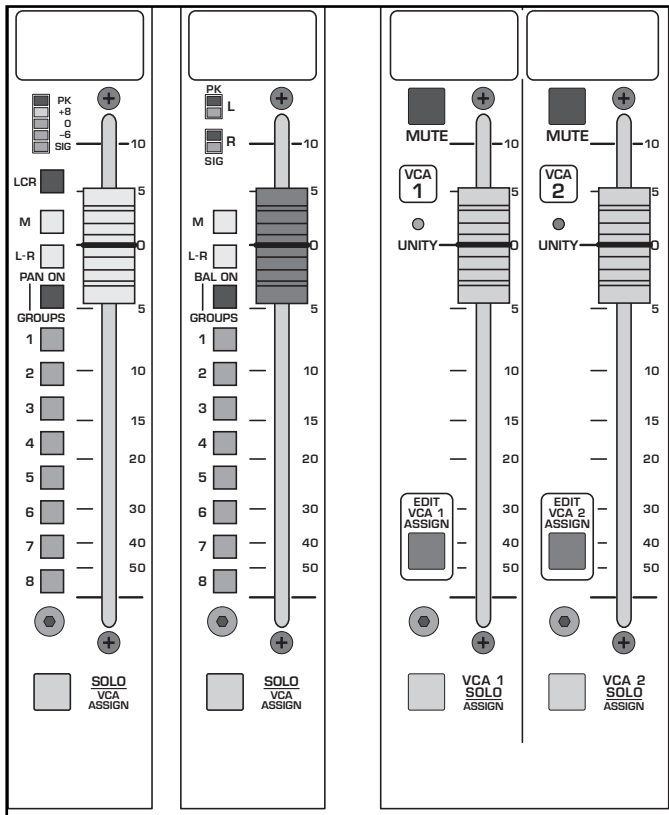

micro control panel

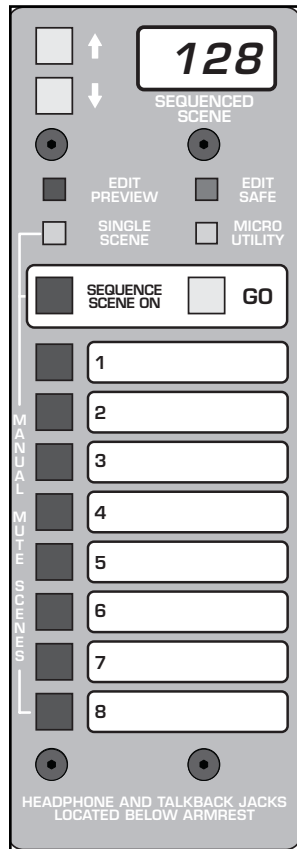

VCA assignment 2 Detailed Operation

There are two methods for doing VCA Assign on the X-VCA.

Note: Front Panel Switches are indicated by BOLD-HYPHENATED-CAPITALIZED-TEXT. For the 8 VCA Masters, the switch to select the Master for editing is indicated by "EDIT-VCA#-ASSIGN", # represents a number 1 thru 8. This second method assigns Masters to Channels:

One of the 8 VCA Masters is selected and its assignment to all of the Channels can be viewed at a glance. The assignment to that selected Master can be cleared, and changes can be made as needed. A new Master can then be selected for viewing / editing, or the same Master can remain selected and the Scene number can change (using the Scroll Buttons). For this second instance to occur, the VFS switch must be down and steady Red. If the VFS switch is not depressed, or if it is blinking Red, the assignment changes will only affect Scene-0.

VCA Assignment- Masters to Channels:

1. Starting with the Console in NOM Mode, one of the 8 EDIT-VCA#-ASSIGN switches is pressed.
2. Any Solos that were active are cancelled, the Console SOLO system is disabled. The Channel Status LEDs switch over to display VCA Safe status.
3. The selected EDIT-VCA#-ASSIGN sw begins to blink, indicating that the Console is in VEM Mode
4. The VCA Assignment and Mute data for this Edit will become active, replacing the prior, Normal Data.
5. If the VFS Sw is UP, any edits are performed on Scene-0, If VFS is Down (lit RED), the edits will apply to the Scene number indicated on the display.
6. ALL Channels that this Master is assigned to (for this Scene) will have their SOLO LEDs blinking.
7. The user can then view the Master's assignment by observing the blinking LEDs of the Channel Solo switches.
8. The User can choose to Clear the assignment (un-assign ALL Channels) by holding down the currently selected EDIT-VCA#-ASSIGN switch for at least 2 seconds. All assigned Channels will then be un-assigned for this Master for this Scene. Note: There is no indication or warning that this Clear will occur; so be cautious.
9. The assignment can be changed by pressing any of the Channel SOLO switches. The LED will change state, assigning or de-assigning that Channel to that Master. Only Channels can be assigned to a VCA Master; so only Channel SOLO switches have any effect at this time, other non-relevant SOLO switches are ignored.
10. The next Master to be viewed can now be selected by pressing its EDIT switch- Go to step 3
OR- the same Master can remain selected and the next Scene assignment viewed.
11. Use the Scroll Up/Down arrows to select another Scene to view (if VFS is Down). The current assignment will automatically carry over to the following higher numbered Scenes, that assignment can be edited and then the edited version carries over to any higher numbered Scenes.
12. The user scrolls to the desired Scene and changes the assignment as in Step 6.
13. To exit VEM Mode, the currently selected EDIT-VCA#-ASSIGN switch is pressed again. It stops blinking, the Console returns to NOM Mode. The initial Scene # is restored if a scroll button changed the Scene # during the Edit process –OR- The user can press the EDIT-CHAN-VCA-ASN button and jump directly into VCA Assignment Method –I (see previous page).

7 vca facilities

Inputs and outputs

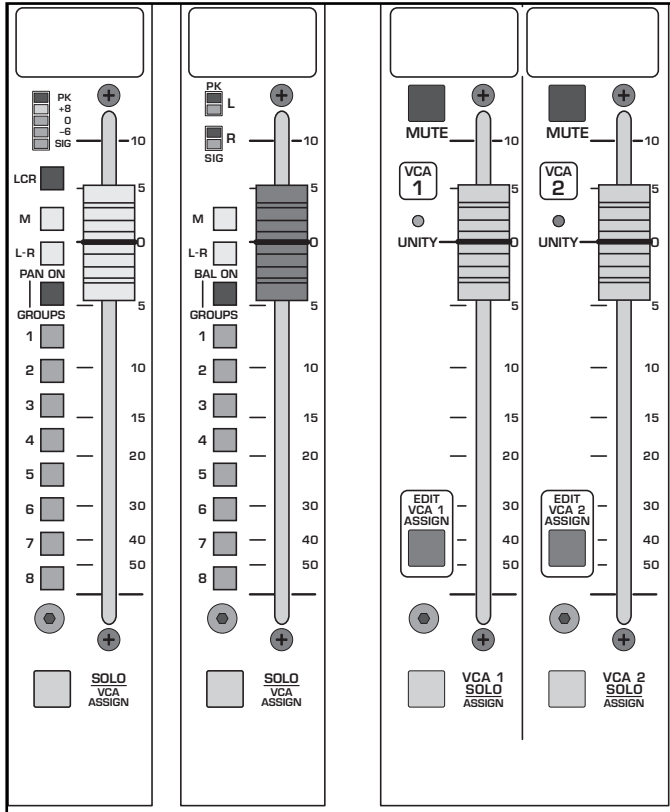

micro control panel

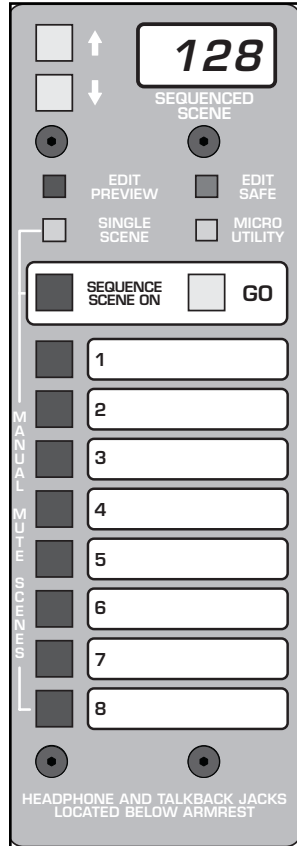

VCA copy

It is possible to copy a VCA assignment from one Scene location to another. Copies can be made between Scene-0 and any Sequenced Scene, or a copy can be performed from a Sequenced Scene to Scene-0, or between two Sequenced Scenes. The Copy function is a one-shot only process, multiple Paste operations cannot be performed. A VCA Copy can only be performed while the Console is in Edit VCA Master Mode. Although you can only edit one Master at a time, the Copy function copies ALL VCA assignment data in that Scene, not just the Master you happen to be editing. Follow these steps to perform a VCA Copy:

1. Enter VCA Edit Mode by briefly pressing one of the 8 Edit VCA Master switches
2. It will begin to blink and the Console will enter VCA Edit Mode
3. If the VFS switch is UP, you will be editing Scene-0 data. If Down (lit), the display will indicate which Seq Scene you are currently on. You can move between Scene-0 and the Seq Scenes by using the VFS switch.
4. If you wish to copy from a Sequenced Scene, press the VFS switch down.
5. Use the Scroll buttons to move to the Scene number you wish to Copy FROM
6. Press the Edit Preview (Copy) button on the Micro Control Panel
7. It will begin to blink indicating that the Scene data has been copied to a buffer
8. The NEXT button will light up. This is the Paste button for this procedure
9. Use the Scroll buttons to move to the Scene you wish to Copy TO, or release the VFS switch if you wish to paste the data into Scene-0.
10. Press the NEXT (Paste) button to complete the operation. The current Scene data is replaced by the copied data.
11. The Edit Preview and NEXT switches turned off after the Paste operation, to perform another Copy, go to Step 3
12. If you wish to abort a Copy operation, re-press the blinking Edit Preview (Copy) button. It will turn off along with the NEXT button.
13. Re-press the original (now blinking) Edit VCA Master switch to de-select it and return to Normal Operate Mode.

7 vca facilities

Inputs and outputs

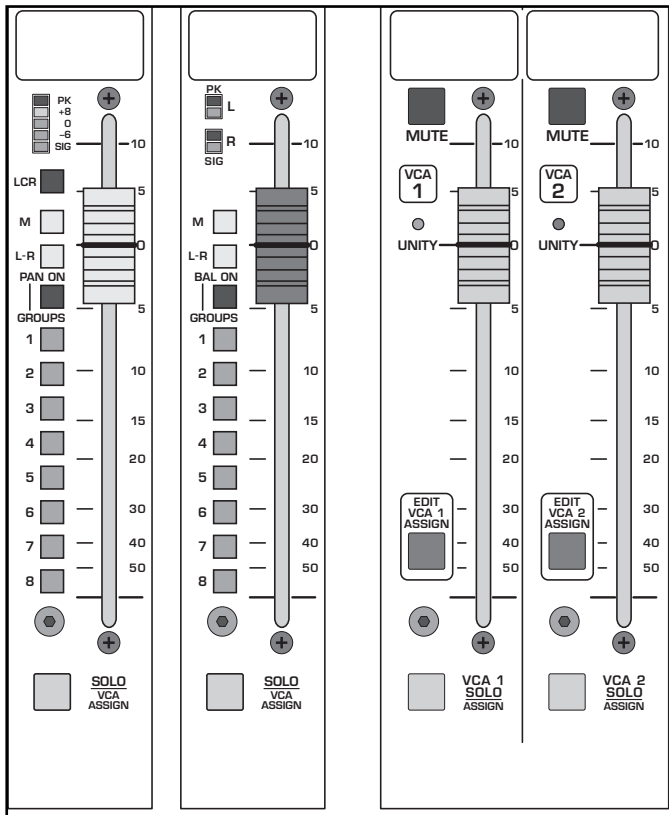

micro control panel

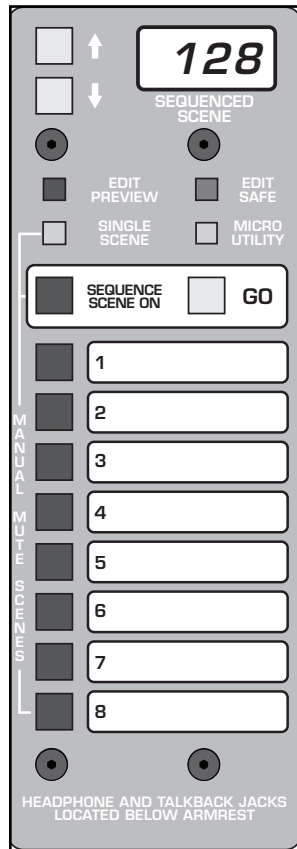

VCA Assignment - starting fresh

When creating an assignment list for a new show, it's usually a good idea to clear out the assignments from the previous show. Even though editing assignments is not difficult, there may be a series of edits that you may run into in your old list that need to be cancelled. Instead of having to worry about which assignments need to be changed, the X-VCA permits the assignments to be cleared by using the Utility function of the Micro. Two separate clear functions are provided; the first clears the Default Assignment, the second clears the Sequenced Scene Assignments. The Default Assignment is also referred to as the "Scene-0" Assignment. This is the VCA assignment the Console reverts to whenever the VFS (VCA Follow Scene) switch is in the UP position. Any VCA edits performed while this switch is UP affect this Default Scene. The Sequenced Scenes are the 128 Scenes accessed by the Recall (Next) button. Each press of this button steps the Console to the next Scene in the list. This recalls the stored VCA assignments plus any Scene Mutes that are stored. To Clear the two VCA Assignment memories, use the Utility Mode:

1. Press the Utility switch on the Micro Panel, it will latch down, putting the system into Utility Mode.
2. Use the Scroll Down key until you see "VCA0" or "VCAS" in the display. VCA0 represents the Default Scene-0, VCAS represents ALL the Sequenced Scenes (128 total).
3. To clear the Default Scene, press the NEXT button when "VCA0" is shown in the display.
4. The display will now show "Clr?". Pressing the NEXT key again will clear the VCA assignment for the Default Scene-0. The display will show "***", and ALL Channels will be un-assigned to all VCA Masters for the Default Scene-0.
5. If you don't wish to perform the Clear, press the Scroll Up or Down key. The display will show "Hold". Pressing the NEXT key will maintain (Hold) the current Default assignment and allow you to go on to other Utility functions.
6. If you wish to clear ALL the 128 Sequenced Scene VCA assignments, perform steps 3, 4 & 5 as above, but starting with "VCAS" in the display.
7. Press the Utility button again to release it to exit Utility Mode and return to Normal Operating Mode.

7 vca facilities

Inputs and outputs

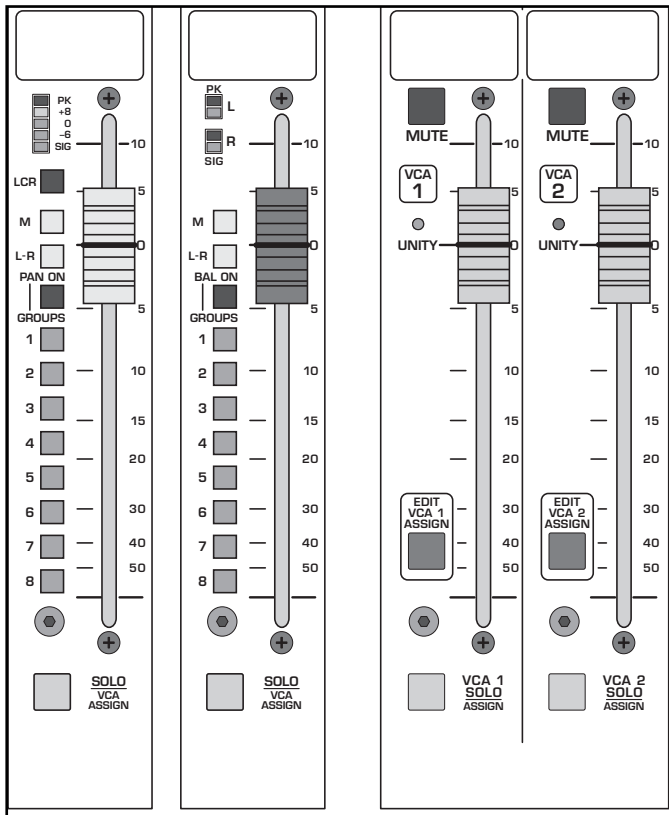

micro control panel

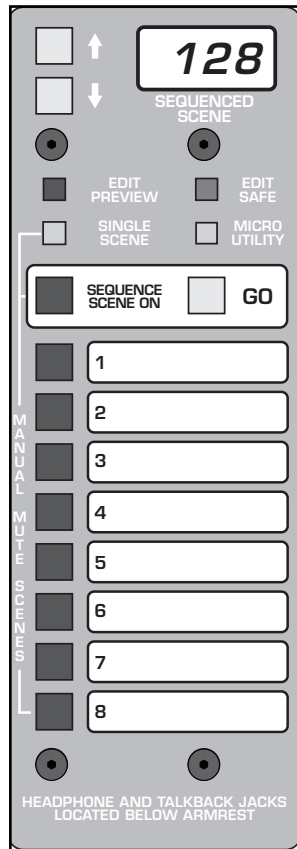

VCA Mute switch

Each of the 8 VCA Masters has a Mute Switch associated with it. When this momentary switch is pressed, it will light steady RED and all Channels assigned to that VCA Master, for that Scene, will mute. Pressing the Mute switch again will cause it to turn off, and any Channels assigned to that VCA Master will un-mute. This Mute switch is under Local control only, its On/Off status is not stored with any of the Mute or VCA Scenes. However, if it is active (ON) and the VCA assignment changes because of a Scene change, the newly assigned Channels will mute. You can think of the VCA Mutes as eight additional Mute Scenes which can change on a Scene-by-Scene basis. When a Channel is muted via a VCA Mute, only the Channel MUTE LED will illuminate, the Safe/Preview LED associated with each Chan Mute will not. This Safe/Prev LED only lites RED when a Micro or Manual Mute is commanding the Channel to Mute. Two conditions will prevent a Channel from muting with a VCA Mute:

1. Channel has been "Mute Safed". If a Channel has been set to Mute Safe (using the Edit Safe Mode), the Channel's Safe/Prev LED will be steady Green and the Channel will ignore ALL mute commands except for the Local Mute. With the X-VCA, this also includes the VCA Mute.
2. Channel has been "VCA Safed". With the X-VCA, it is possible to SAFE a Channel from its VCA assignment. This Safe will also prevent the Channel from responding to a VCA Mute, the Channel ignores not only the VCA assignment, but also any VCA Mutes. The Channel will still respond to all other Mute commands

In the X-VCA, a Channel can be muted by any of the following 4 methods:

1. Micro Mute- Mute command from one of the 128 Sequenced Mute Scenes (Use Edit Preview to program). Safe/Prev LED will light steady RED when active. Local Mute Sw cannot change Channel mute state unless Console is in EOF Mode.
2. Manual Mute- Mute command from any of the 8 Manual Mute Scenes (Use Edit Preview to program). Safe/Prev LED will light steady RED when active. Local Mute Sw cannot change Channel mute state unless Console is in EOF Mode.
3. VCA Mute- Mute command from any of the possible 8 VCA Masters that the Channel has been assigned to (Use either of the VCA Edit Modes to assign). Local Mute Sw cannot change Channel mute state, and the Channel Safe/Prev LED is unaffected. EOF Mode has no affect on VCA Mute. A Channel can only be un-muted by releasing the VCA Master Mute, or setting the Channel to VCA Safe or Mute Safe. A Channel will not respond to a VCA Mute (or a VCA level change) if it has been set to VCA Safe, it no longer thinks it's assigned to that (or any other) VCA Master.
4. Local Mute. If no other Mute is present (Micro, Manual or VCA), this momentary switch will toggle between On/Off with each press to locally mute a Channel. Additionally, the LED in the switch indicates a Channel mute (from any source) by turning RED. If EOF Mode is active, the Local Mute switch will toggle a Channel mute Off and On if a Micro or Manual Mute command initially caused a Channel Mute. The Safe/Prev LED will blink, in this case, if a Channel's mute status was changed from Mute to un-Mute by using the Local Mute Switch. It will return to steady RED if the Channel is re-toggled to the muted state using the Local Mute Sw. If EOF Mode is OFF, the Local Mute Sw has NO EFFECT on the condition of the Channel's mute. Prior versions of X-Eight software allowed a "Hidden" mute to occur behind the Micro Mute. Once the Micro Mute was removed, the Channel may or may not have remained muted, depending on how many presses (odd or even) that the user applied to the Mute Sw while another mute was present. This hidden-mute "feature" has been removed on X-VCA.

7 vca facilities

Inputs and outputs

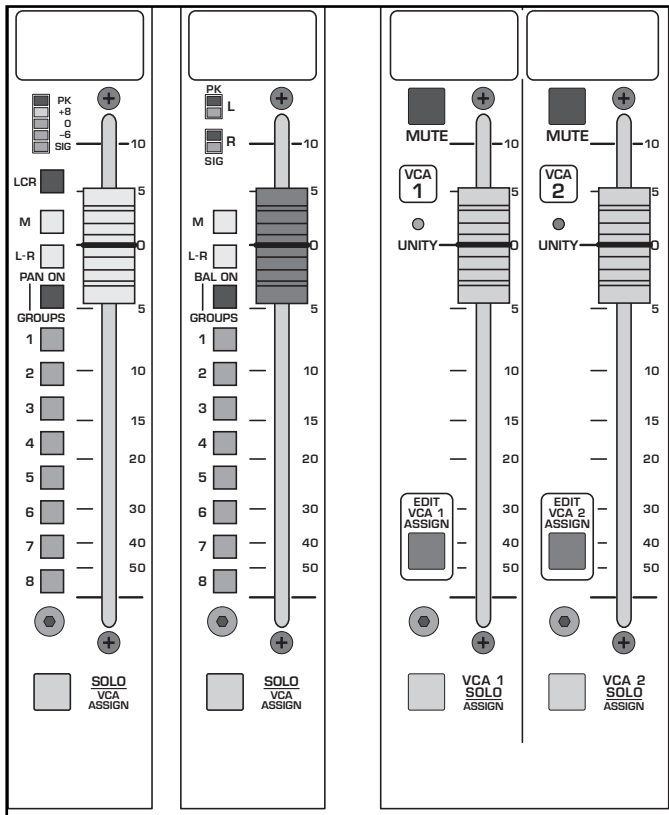

micro control panel

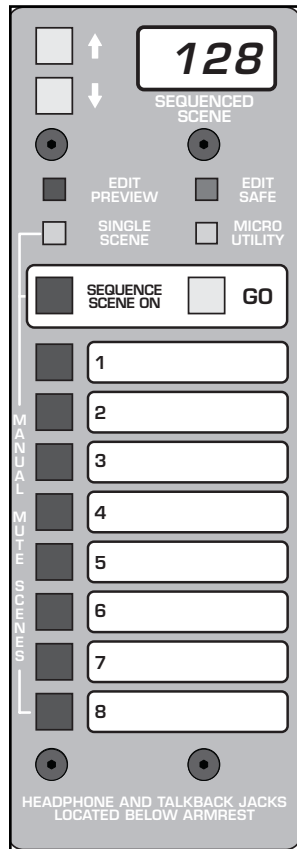

VCA Master Solo/Assign switch

Each of the 8 VCA Masters has its own SOLO switch. This switch has 2 functions-Solo and Assign:

VCA Assign: When in Edit Chan VCA Mode, this switch is used to assign a Master VCA to a Channel for a particular Scene (Default Scene-0 or one of the 128 Sequenced Scenes). Pressing the switch will toggle it from ON-blinking (Channel assigned), to OFF (Channel un-assigned).

VCA Solo: The second function of the switch is VCA Solo. When the Console is operating in Normal Mode, pressing this switch will activate the Solo of ALL Channels (Inputs and Groups) assigned to that VCA Master for that particular Scene. This Solo switch follows the two Solo modes: Additive and Last Pressed.

If in Last Pressed Mode, the VCA Solo switch is treated as any other Solo switch on the Console; pressing it will clear any previous active solos and activate itself (LED turns ON) and all Channels (by activating their Solo LED and circuitry) assigned to it (for that Scene). Pressing any other Solo switch while that VCA Solo is active will turn off that VCA Solo and all Channels associated with it. This last function will also work within the VCA Solo grouping; if the Solo sw of one of the Channels activated by the VCA Solo is pressed, that Channel will remain solo'd while clearing out the rest of the group. The SOLO CLEAR switch always performs as expected; pressing it clears ALL active Solos.

If in Additive Mode, pressing the VCA Solo switch will turn on its LED and add the assigned Channels (by activating their Solo LEDs and circuitry) to any other currently active Solo signals. Pressing the VCA Solo switch again will turn its LED off and will remove those assigned Channels from the Solo system (by de-activating their Solo LEDs and circuitry).

Listen to one Channel of a VCA Group (Additive Mode): If a single Channel of group is individually solo'd and then its VCA Group is solo'd, the first Channel remains solo'd and the other members of the VCA Group are added to it. When the VCA Solo is de-activated by re-pressing the VCA Solo switch, the initial Channel remains solo'd. It can be cleared by the Solo Clear switch or by re-pressing its own Solo switch. This feature allows the operator to listen to an isolated member of a group first and then add the rest of the group to the solo mix. An example would be – monitor one of the back-ground singers (all assigned to the same VCA Group) by pressing the desired Channel Solo sw. Now listen to the blend of all the background vocals together by pressing the VCA Solo sw. Now return to monitoring the original Channel by re-pressing the VCA Solo switch to de-activate it and its assigned Channels- except for the original Channel which remains solo'd because it had been solo'd prior to the VCA Group being selected.

7 vca facilities

Inputs and outputs

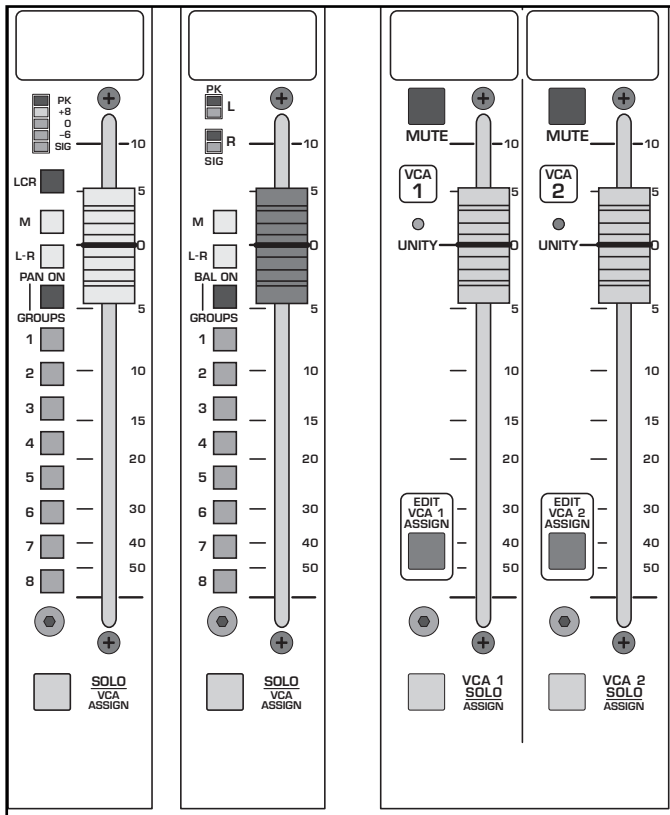

micro control panel

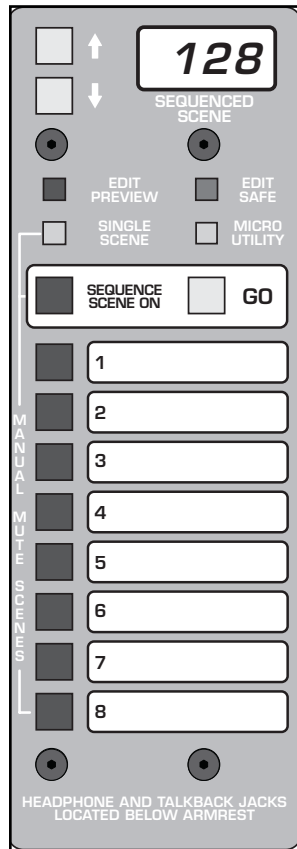

VCA channel solo

Solo operation of a Channel assigned to multiple VCA Groups:

It is possible for a Channel to be assigned to more than one (up to 8 possible)VCA Masters. How it responds to multiple VCA Solos is now discussed.

In Additive Mode, more than one signal can be solo'd. If a single Channel is assigned to multiple VCA Groups, and those VCA Groups are simultaneously solo'd (via their VCA Solo switch), the Channel has to respond properly to the different Solo combinations. The different possibilities are listed below:

1. Channel individually solo'd, then 1 VCA Group also solo'd:

Channel remains solo'd as other channels in Group become active because of VCA Solo. When VCA Solo OFF, initial Channel stays solo'd, other channels in Group un-solo (Case outlined above- Listen to one Channel, then others in the Group, then back to initial Channel)

2. Channel initially un-solo'd, then 1 VCA Group solo'd:

Channel solo is activated along with other channels of Group. If Channel is individually un-solo'd, rest of channels in Group stays solo'd, VCA Solo-OFF un-solos all.

3. Channel initially un-solo'd, then multiple VCA Groups solo'd:

Channel solo is activated along with other channels of any solo'd Groups. If Channel is individually un-solo'd, the rest of the channels in that Group stays solo'd, VCA Solo-OFF un-solos all channels of that particular Group. The solo function of a particular Channel is an OR operation on the solo commands from each of the possible 8 VCA Groups the Channel is assigned to, plus the local Channel solo. Once a Channel is solo'd by a VCA Solo-ON command (or multiple VCA-Ons), pressing the Channel Solo Switch will un-solo the Channel. By re-pressing the Chan Solo Sw, the Chan solo will once again become active, but the Chan will no longer be associated with any particular VCA Group. Solo Clear, or re-pressing the Chan Solo Sw will be the only way to un-solo the Channel at this point. If another VCA Group Solo is activated, and the Channel is assigned to that Group, the Channel will solo, and the Channel will be associated with that VCA Group. If that VCA Group Solo is turned off, the Channel will follow and also un-solo.

8 Solo - VCA edit switch

Inputs and outputs

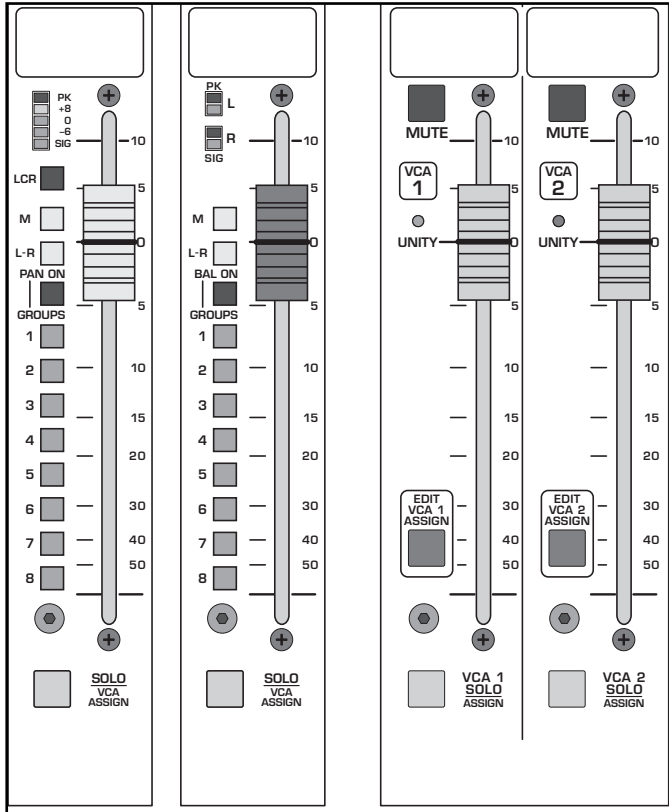

micro control panel

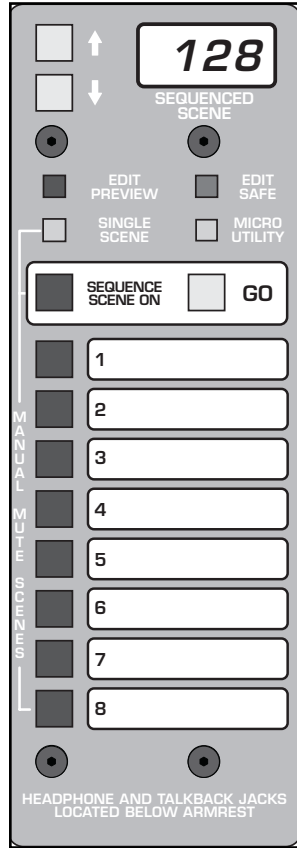

Solo - VCA edit switch

Throughout the X-VCA console, Stereo Solo/VCA edit switches can be found on just about every input and output.

The Solo - VCA edit switch has two functions: it can be used to activate or deactivate the channels solo feature, or it can be used to include or exclude the channel from one or more VCA groups.

Solo Functions



Pressing this switch will include (solid illumination) or exclude (not illuminated) the input channel from the console's solo system. As determined by a switch within the master solo control section, signal may be monitor pre fader (in stereo) or post fader/post balance pot in correct panoramic positioning. Once placed in the console solo system, the channel may be removed locally by pressing the switch again. The channel also may be removed by using the Solo Clear function or by pressing another channel's Solo-VCA Edit switch when the Last Pressed solo mode is selected in the master section. (See master section - solo control.)

When illuminated, it indicates that the channel is being solo'd and may be heard within the master monitor section as well as displayed on the left/right solo meters.

VCA Channel Assignment Function



When the console is placed in VCA Edit mode, this switch is used to include the channel in, or exclude it from, one or more VCA groups. For a complete discussion see the section on VCA Group Operation.

X-VCA dynamics control

Introduction

The X-VCA includes a number of features for control of signal dynamics in both the Audio Group and Master sections. In many situations, these on-board features eliminate the need for outboard dynamics processors. This not only reduces costs and conserves rack space, but also allows operators to keep their attention focused on the console at all times.

Note: The following material is not intended to serve as a comprehensive discussion of general principles and techniques involved in dynamics processing. The content here is restricted to the specific controls and applications of the X-VCA. It is assumed the operator is familiar with general approaches to dynamics processing.

Group section: Compressor/Limiter functions

The gate and compressor functions affect all signals summed into their respective Audio Group buses. Also, since the Audio Group external inputs are located pre-dynamics, the compressor/limiter and gate functions also can be used to control dynamics of an external signal (e.g. separate submixer).

To set up the compressor/limiter function:

1. If desired, link adjacent odd and even channels for stereo operation - Pressing the STEREO LINK switch links the two channels for stereo operation. The channel with the highest amount of attenuation becomes the controlling channel for both channels of the stereo pair. This ensures that the stereo signal tracks evenly in the final stereo mix. The LED lights to indicate stereo link is active.

NOTE: You may use the stereo link function to key operation of one channel by the signal of the paired channel. To do this, first set the controlled channel Ratio to 1:1 and Threshold to 0 or above. Then, set the controlling channel Threshold and Ratio controls to achieve the desired compression effect on the controlled channel.

2. Select compressor mode (VOX, PERC or AUTO) - Selecting either or both switches turns the Compressor system on. The ON/THR LED will light to indicate compressor function is active. Press VOX for attack and release times optimized for vocals (slow averaging). Press PERC for attack and release times optimized for percussion (fast averaging). Press both for AUTO mode (attack and release times are determined by signal characteristics).

3. Select Hard or Soft Knee - Pressing this switch down sets the compressor for a Soft Knee characteristic. When the threshold level is reached, the onset of compression is gradual, with the ratio increased "softly" until the set ratio is reached. Soft Knee compression tends to be more forgiving and "musical." When the switch is up, the compressor/limiter exhibits a "hard knee" characteristic. When input signals reach the threshold, output is immediately reduced by the set ratio. This characteristic is best employed for overload protection using higher threshold settings.

4. Set compressor/limiter threshold - Set the COMP THR control to the input signal level where you wish compressor action take effect. Any signal level above this setting will cause a reduction in output signal as determined by the RATIO setting. The dual color ON/THR LED lights red when the signal surpasses set threshold level.

5. Set compressor/limiter ratio - Set the COMP RATIO control to determine the desired amount of proportional amount gain reduction to occur whenever the input signal exceeds the threshold setting. Ratio is adjustable from 1:1 to 20:1 (hard limiting).

6. Set compressor make-up gain - This control adjusts to make up for apparent loss of gain due to compression of the input signals. To view the output of the post-dynamics Audio Group, select SOLO in the pre-fader (default) mode. This shows the output level following dynamics control and before any effects of the VCA control system (if engaged for this Audio Group). The COMP GAIN control should be adjusted to show close to 0dB reference level when normal signals are present. The GAIN control has a range of 0dB to +20dB.

Once set-up is complete, the effects of compressor/limiter action can be viewed on the ATT gain reduction meter. This meter shows overall reduction applied by the dynamics system.

NOTE: When the gate function also is engaged, the meter displays attenuation applied by both the compressor and gate functions. However, in most applications, only one function will be active at any given moment. Active function is indicated by red illumination of either the compressor ON/THR LED or the gate ON/THR LED.

Caution should be exercised in operation of the dynamics system if the ATT meter displays frequent or constant full-scale deflections.

7 dynamics control

X-VCA owner's manual

group section: gate functions

Each Audio Group also incorporates a "noise gate" function. In live sound applications, this feature is most commonly used to eliminate unwanted leakage from surrounding sources into on-stage microphones (on drum kits in particular). Although the term "gate" is used here for the sake of simplicity, the X-VCA "gate" system actually functions as a downward expander. Where a traditional gate is either "on" or "off", a downward expander attenuates signal proportionally at descending levels below the threshold point. As a result, downward expanders tend to be more forgiving in their characteristics.

To set up the gate function:

1. Turn the gate on - Press the GATE switch. The ON/THR LED will light to indicate gate function is active.
2. Set the gate threshold - Turn the center knob of the dual concentric THR/RAT control to set the input signal level below which gating function will take effect. Gate threshold may be set to any level from -20dB to -60dB (and below). The gate ON/THR LED lights when input signal drops below the set threshold.
3. Set the gate ratio - Turn the outer ring of the dual concentric THR/RAT control to set the gates downward expansion ratio. Above the set threshold, signal will be tracked at 1:1. Below the threshold, the output signal will be further decreased (attenuated) by the ratio selected.

Once set-up is complete, the effects of the gating function can be viewed on the ATT gain reduction meter. This meter shows overall reduction applied by the dynamics system.

NOTE: When the compressor/limiter function also is engaged, the meter displays attenuation applied by both the compressor and gate functions. However, in most applications, only one function will be active at any given moment. Active function is indicated by red illumination of either the compressor ON/THR LED or the gate ON/THR LED.

7 dynamics control

X-VCA owner's manual

output limiter functions

The X-VCA provides output limiters inserted in the main output circuits following the L/R Stereo and Mono master faders. These limiters function with an RMS characteristic, and will therefore pass short term program peaks without attenuation or audible signal degradation. The X-VCA output limiters are best used for system protection, or to aid the operator in keeping within maximum sound levels as set by local noise ordinances.

To set the output limiters:

1. Turn the limiter function on - Press the LIMIT ON button to activate the limiter function. Note that the limiter function affects the respective main outputs only. The Alternate, Monitor and Assisted Listening outputs are not affected by the limiters.

2. Set the output limiter threshold - Set the control to the input signal level at which limiting function is desired. Input signal above the threshold will cause a leveling of the output signal at a ratio of greater than 20:1. Initial onset of limiting is a modified rapid soft-knee characteristic before hard limiting occurs. The threshold control may be set for onset of limiting at any output level between -6dBu and +20dBu.

The eight segment ATT output meter displays effect of output limiting. The top segment indicates limiter function is ON. The remaining seven segments indicate amount of signal attenuation when master bus signal exceeds the set threshold.

Note: Caution should be exercised if the output ATT meter shows constant attenuation, or significant attenuation at frequent intervals. This could indicate some deterioration of the output signal quality.

Note: EXTREME caution should be observed when turning the limiter function off. If the limiter is currently attenuating the output, removing the limiter from the circuit could result in a sudden increase in output signal with possible damage to speakers.

8 power supply

model 5A power supply

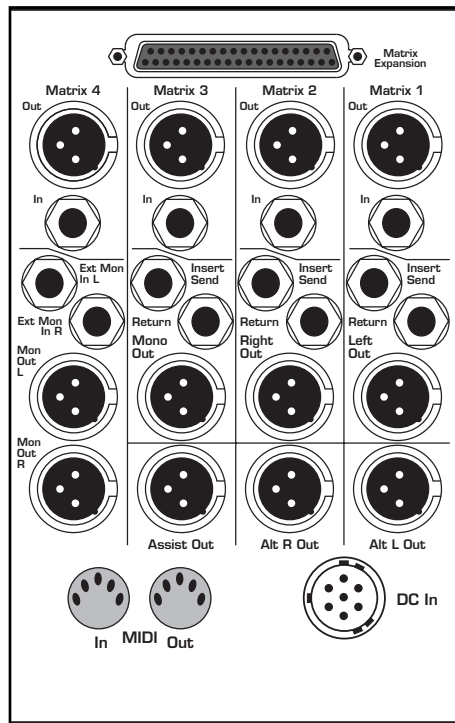
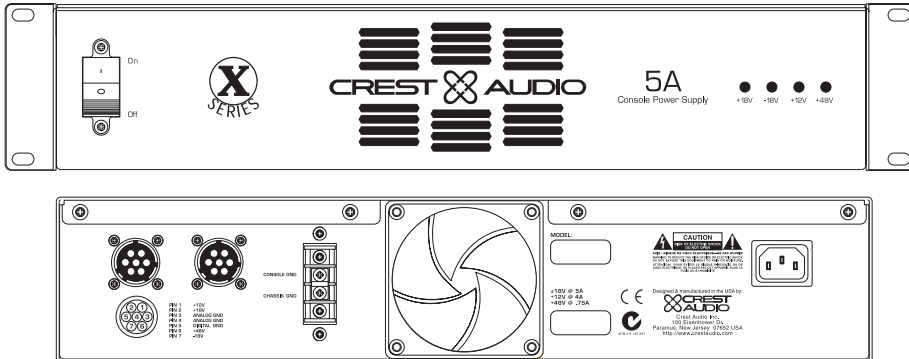

power supply usage

console and power supply grounding

Console chassis ground is electrically connected to: the audio ground, pin-1 of XLR connectors, the sleeves of 1/4" sockets, and to the terminal CONSOLE GROUND at the rear of the power supply.

The AC third-wire connection in the power supply cable connects the metal chassis of the power supply to safety ground.

Rack-mounting—the power supply ground may transfer to the rack case through the front fixing screws, though this connection is not reliable.

Sound system use—the grounding requirements may call for the ground link to be disconnected. This is permissible only when an alternative ground path has been provided. If in doubt seek the advice of an experienced electrical engineer.

redundant power supplies

The console power supply can be considered the single most important component in an entire sound system. If a power amplifier, a signal processor or a console input goes down in the middle of a show, the show can still go on. But if the console loses its power supply, the show is over. For this reason, it is always good practice to incorporate redundant power supplies for mixing consoles used in professional sound reinforcement applications.

This should be considered a high priority even when using a very reliable power supply. In even the most carefully designed sound systems, each component runs the risk of failure at sometime or another.

Crest Audio uses two methods for attaching redundant power supplies to consoles. In both methods, the two (or more) power supplies should be kept on while the console is in use to insure a smooth transition in the event that one shuts off.

If one power supply drops in voltage or shuts off completely, the other unit takes over without any interruptions or audible glitches. As an added precaution, the two (or more) power supplies can be fed by separate AC lines. This will guarantee that the console does not shut off if one of the AC lines goes down.

multiple power supplies in-series

Crest Audio X-Series consoles use this method for backup. Since each power supply includes voltage switching circuitry, more than two units can be hooked up in series. A DC link cable ties the power supplies together.

model 5A power supply

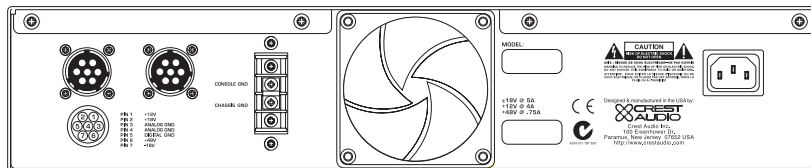

specifications

output power	+18V @ 5A DC -18V @ 5A DC +12V @ 4A DC +48V @ 0.75A DC
DC out receptacle	two Hirose JRI6RK-7S connectors on rear connector meets JIS C 5432 standard
DC out cable	grey polyurethane outer jacket, 15 feet long seven-way, 14-gauge stranded conductors rated 600 volts, 80 degrees C UL and CSA approved Hirose JRI6PK-7S and JRI6PK-7P connectors fitted
AC mains power supply	90 to 250 volts @ 4.5 amps maximum universal AC input voltage. No changes needed 0.5 amps idle
AC mains receptacle cable	IEC 320 C-13 3-pin 15 amp receptacle removable IEC type with country-specific mains plug fitted UL, CSA, and CE
approvals	two-space 19 inch rack mount unit
chassis	3.5 inches tall, 17 inches wide, 12 inches deep. weight: 18 pounds

power supply usage

supply identification

The type of power supply can be identified by the model number shown on the back of the chassis and panel label.

power requirements

The X series power supplies have certain electrical requirements for proper operation. If possible the power supply should be connected to a dedicated circuit. Should any other appliance on the same circuit draw enough current to overload the circuit, the breaker or fuse will trip causing loss of power to the console.

The power switch on the supply front panel is also a circuit breaker; there is no power fuse. Should the supply ever shut down, or trip at start up, simply push the switch to the off position and then push on again.

ground linking

SAFETY CONSIDERATIONS—each new power supply is shipped with the AC third-wire ground connected to the console chassis ground. The connection is made at the rear of the power supply unit. This is necessary for safety reasons so that exposed metal parts are grounded. In the event of a live conductor making contact with the console chassis or the power supply chassis then the current will flow to ground without a safety hazard arising.

Uninterruptible grounding—in a fixed installation for example, make a connection directly to the console chassis from the safety ground. Disconnect the ground link on the rear of the power supply. This disconnects console ground from power supply AC third-wire ground which could possibly create a hum-loop.

twin-supply operation

When twin-supplies are in use for automatic back-up, then the ground links on both supplies should be fitted.

In a situation where the safety ground to the console chassis has been connected and the ground path via the power supply is causing a hum-loop, then disconnect the ground links on both power supplies.



v. 1.1

01/25/01

Crest Audio Inc.
100 Eisenhower Dr., Paramus NJ 07652 USA
TEL: 201.909.8700 FAX: 201.909.8744
www.crestaudio.com

Free Manuals Download Website

<http://myh66.com>

<http://usermanuals.us>

<http://www.somanuals.com>

<http://www.4manuals.cc>

<http://www.manual-lib.com>

<http://www.404manual.com>

<http://www.luxmanual.com>

<http://aubethermostatmanual.com>

Golf course search by state

<http://golfingnear.com>

Email search by domain

<http://emailbydomain.com>

Auto manuals search

<http://auto.somanuals.com>

TV manuals search

<http://tv.somanuals.com>