

TransFex™ 208s



TRANSTUBE
TECHNOLOGY



PEAVEY

OWNER'S MANUAL



Intended to alert the user to the presence of uninsulated "dangerous voltage" within the product's enclosure that may be of sufficient magnitude to constitute a risk of electric shock to persons.



Intended to alert the user of the presence of important operating and maintenance (servicing) instructions in the literature accompanying the product.

CAUTION: Risk of electrical shock – DO NOT OPEN!

CAUTION: To reduce the risk of electric shock, do not remove cover. No user serviceable parts inside. Refer servicing to qualified service personnel.

WARNING: To prevent electrical shock or fire hazard, do not expose this appliance to rain or moisture. Before using this appliance, read the operating guide for further warnings.



Este símbolo tiene el propósito de alertar al usuario de la presencia de "(voltaje) peligroso" que no tiene aislamiento dentro de la caja del producto que puede tener una magnitud suficiente como para constituir riesgo de corrientazo.



Este símbolo tiene el propósito de alertar al usuario de la presencia de instrucciones importantes sobre la operación y mantenimiento en la literatura que viene con el producto.

PRECAUCION: Riesgo de corrientazo – No abra.

PRECAUCION: Para disminuir el riesgo de corrientazo, no abra la cubierta. No hay piezas adentro que el usuario pueda reparar. Deje todo mantenimiento a los técnicos calificados.

ADVERTENCIA: Para evitar corrientazos o peligro de incendio, no deje expuesto a la lluvia o humedad este aparato. Antes de usar este aparato, lea más advertencias en la guía de operación.



Ce symbole est utilisé pour indiquer à l'utilisateur la présence à l'intérieur de ce produit de tension non-isolée dangereuse pouvant être d'intensité suffisante pour constituer un risque de choc électrique.



Ce symbole est utilisé pour indiquer à l'utilisateur qu'il ou qu'elle trouvera d'importantes instructions sur l'utilisation et l'entretien (service) de l'appareil dans la littérature accompagnant le produit.

ATTENTION: Risques de choc électrique – NE PAS OUVRIR!

ATTENTION: Afin de réduire le risque de choc électrique, ne pas enlever le couvercle. Il ne se trouve à l'intérieur aucune pièce pouvant être réparée par l'utilisateur. Confier l'entretien à un personnel qualifié.

AVERTISSEMENT: Afin de prévenir les risques de décharge électrique ou de feu, n'exposez pas cet appareil à la pluie ou à l'humidité. Avant d'utiliser cet appareil, lisez les avertissements supplémentaires situés dans le guide.



Dieses Symbol soll den Anwender vor unisolierten gefährlichen Spannungen innerhalb des Gehäuses warnen, die von Ausreichender Stärke sind, um einen elektrischen Schlag verursachen zu können.



Dieses Symbol soll den Benutzer auf wichtige Instruktionen in der Bedienungsanleitung aufmerksam machen, die Handhabung und Wartung des Produkts betreffen.

VORSICHT: Risiko – Elektrischer Schlag! Nicht öffnen!

VORSICHT: Um das Risiko eines elektrischen Schlages zu vermeiden, nicht die Abdeckung entfernen. Es befinden sich keine Teile darin, die vom Anwender repariert werden könnten. Reparaturen nur von qualifiziertem Fachpersonal durchführen lassen.

ACHTUNG: Um einen elektrischen Schlag oder Feuergefahr zu vermeiden, sollte dieses Gerät nicht dem Regen oder Feuchtigkeit ausgesetzt werden. Vor Inbetriebnahme unbedingt die Bedienungsanleitung lesen.

Features

Congratulations on your purchase of the Peavey TransFex™ 208s. This stereo guitar amplifier represents years of research into guitar tones, as well as effects units, and is one of the most flexible amplifiers of its kind. The preamp consists of the popular TransTube® design borrowed from the Peavey Bandit®, which allows transistors to literally sound like tubes. When combined with the effects section, this amplifier can get almost any sound known to guitar. The effects section is a simplified subset of the TubeFex® effects section, using the same 24-bit DSP techniques with a simpler interface. The amp's 60 presets include the selection of preamp channels and effects with a single press of the footswitch. The effects order is fixed, but any or all of the effects slots can be on and channel switching is instantaneous. There are 8 different effects types: chorus, flanger, phaser, tremolo, delay, reverb, rotary speaker and equalization. Each effect has programmable parameters, so the resulting combinations of tones are almost endless.

- Up to 6 simultaneous effects
- Preset-selectable, two-channel TransTube preamp
- Independent EQ on each channel of the preamp
- Gain switch and Thrash EQ switch on the Lead channel
- Preset-selectable Stereo digital effects processor with 8 effects types
- User-definable effects algorithms
- LED indicators for channel selection
- 30 user presets, 30 factory programs
- 7 preset-selectable digital EQs
- DSP Edge control for customizing highs of reverb and delays
- Preset volume and effects mix programmable per patch
- On-board, full chromatic tuner with selectable mute
- Clip LED
- Dual 25 watt TransTube power amps
- Footswitches with LED indicators for A, B, and C preset and bank selection
- External speaker jacks and stereo headphone jack

Quick Start

Let's Jump Right In (Getting a Good Basic Tone):

After turning on the TransFex 208s, notice that the display reads **0.A**. This number indicates that the preset A of Bank 0 is active. The dot (.) in the middle indicates that this is a user-modifiable preset. **0.A** is the first user preset. To ensure that the basic starting tone is to your liking, press the parameter ▼ button (this is just to the right of the display).

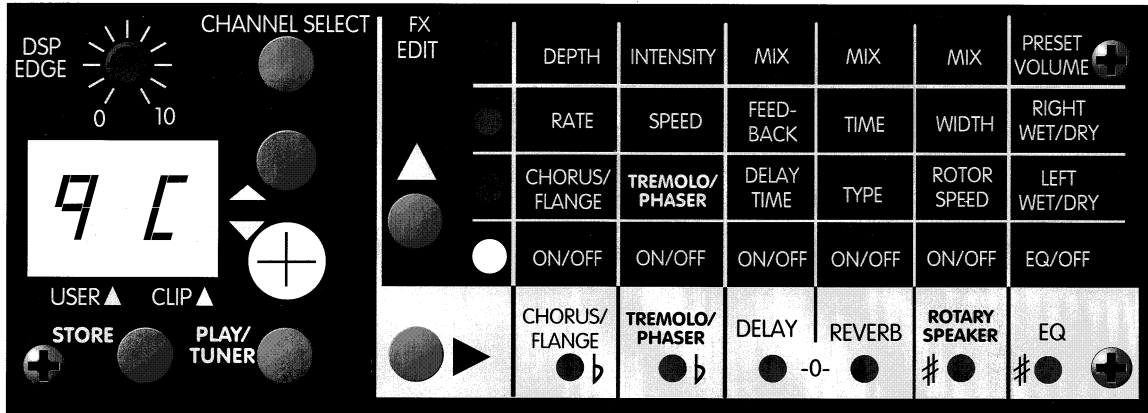

The preset that is active now should be **9C**, the last factory preset. This preset is set on the Clean channel and contains no effects, so you can adjust the Clean channel to your particular taste.

To adjust the Lead channel to your liking, press the parameter ▼ button again. Now you're on factory preset **9B**, which is a dry Lead channel preset. Adjust the Lead channel and you're done setting the amp's basic gain and tone to your personal preferences.

Let's Hear Some Sounds (Checking Out Factory Patches):

After adjusting the clean and lead tones for your taste, use the parameter ▲ or ▼ buttons to step through the factory presets. Note that the presets are numbered **0A** through **9C**. This corresponds to 10 banks (0-9) of 3 patches (A, B, & C) per bank. If at any time you press a wrong button or get confused, you can return to preset **0.A** by simply turning the amp off and back on.

Each preset automatically selects one of the two preamp channels — Clean or Lead. To hear what a preset would sound like using the opposite channel, press the **Channel Select** button.

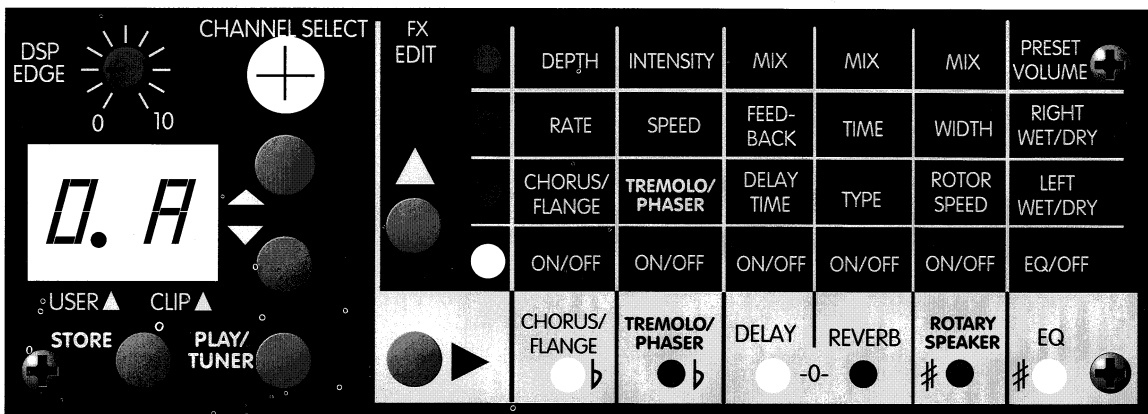

Let Me Edit a Patch (Editing Patches Quickly):

Use the parameter ▲ or ▼ buttons to select a preset you wish to edit. (Make sure the patch is a “user” patch.) Now press the ► FX EDIT button, which puts you in Edit mode. By continuing to press the ► FX EDIT button, you can scroll through the different possible effects.

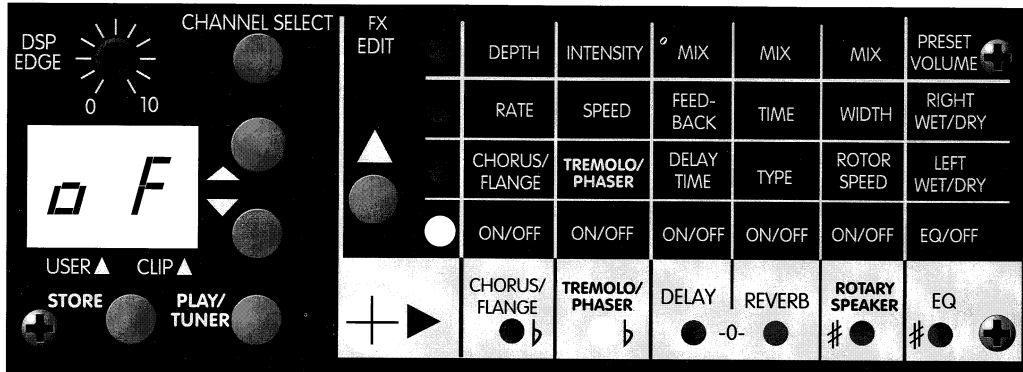

When the LED below the effect you wish to edit lights, you’ll notice that the display reads either **on** or **of** (off). This corresponds to whether the effect is currently in use or not. To change this parameter, use the parameter ▲ or ▼ buttons.

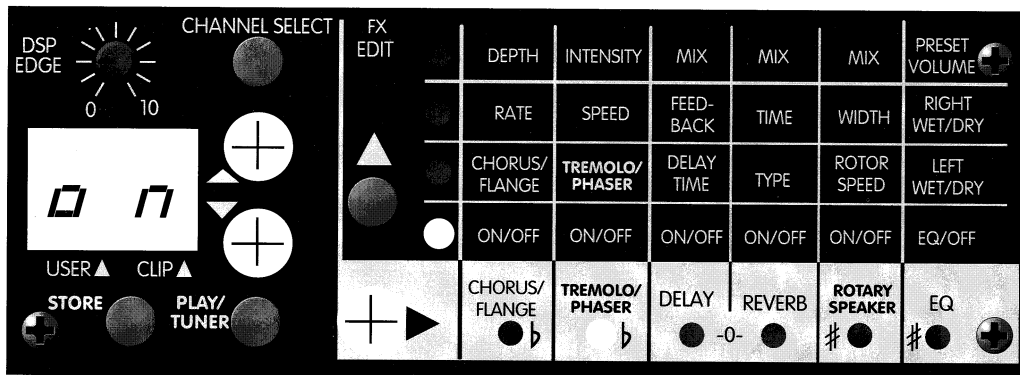

Now, using the ▲ FX EDIT button, step through the various editable parameters of the particular effect you’re adjusting. When the LED lights in the same row as the parameter that you wish to edit, use the parameter ▲ or ▼ buttons to change it to your desirable setting.

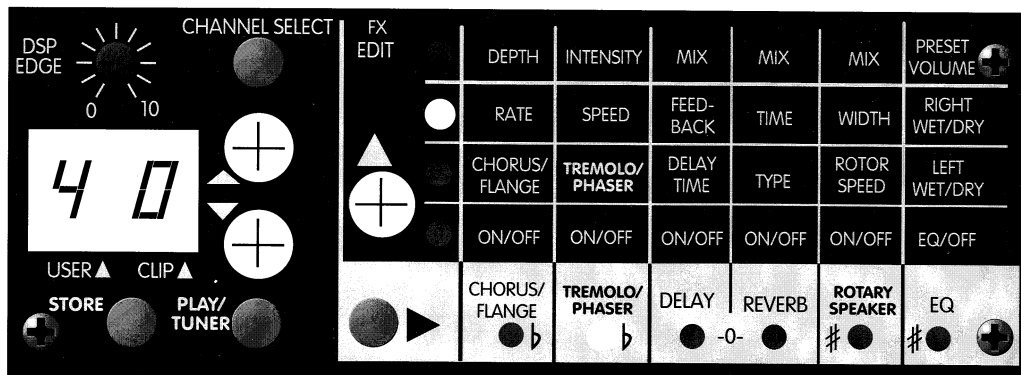

To store your newly created guitar tone, press the **store** button. The display will start to flash, and will indicate the target storage location. You can either use the parameter ▲ or ▼ buttons to change the target location, or just hit **store** again. That’s it.

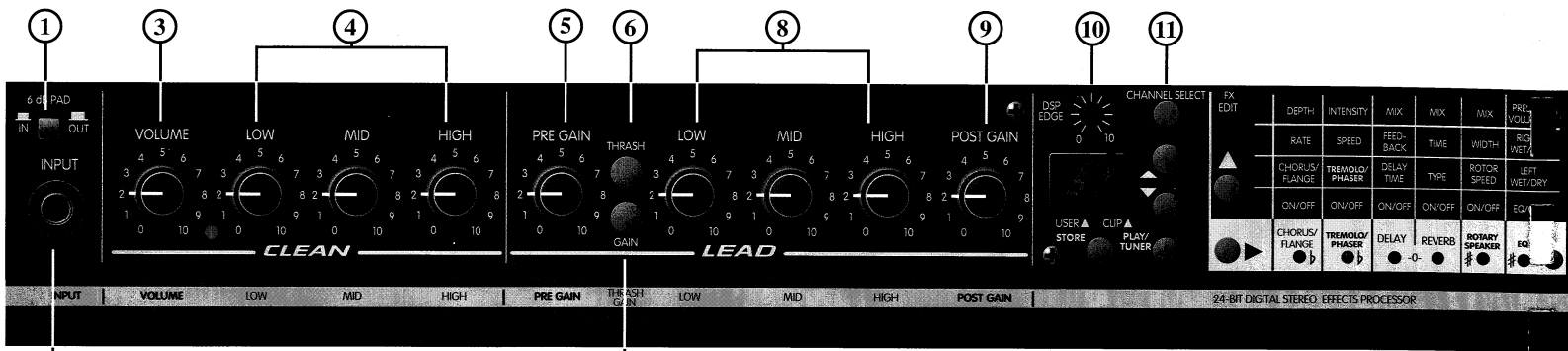

THE FRONT PANEL

INPUT PAD SWITCH (1)

Provided for instruments that have extremely high output, which can result in overdriving (distorting) the input gain stage. Depressing the switch to its “in” position reduces the level of the input signal by 6 dB.

INPUT (2)

The input jack will accept signals from all types of guitar pickups. Be sure to use a high-quality shielded cable to connect the guitar to the amplifier.

VOLUME (3)

Controls the volume level of the Clean channel.

LOW, MID, & HIGH EQ (4)

Passive tone controls that regulate the low, mid, and high frequencies of the Clean channel.

PRE GAIN (5)

Controls the input volume level of the Lead channel.

THRASH SWITCH (6)

Notches the mid-range about 20 dB. Depress to the “in” position to activate.

GAIN SWITCH (7)

Boosts the overall system gain. Depress to the “in” position to activate.

LOW, MID, & HIGH EQ (8)

Passive tone controls that regulate the low, mid, and high frequencies of the Lead channel.

POST GAIN (9)

Controls the overall volume level of the Lead channel. The final level adjustment should be made after the desired sound has been achieved.

DSP EDGE (10)

Global EQ that adjusts the amount of high end on the delay and reverb tails.

CHANNEL SELECT BUTTON (11)

Used to select the desired preamp channel for each preset. If the Clean channel is active, pressing this button will switch to the Lead channel, and vice versa. This change can then be stored in that preset by pressing the **Store** button twice. When in Tuner mode, the **Channel Select** button selects Mute or Clean channel.

THE FRONT PANEL



PARAMETER ▲ or ▼ BUTTONS (12)

Used to select presets when in Play mode, or to adjust parameters when in Edit mode.

STORE BUTTON (13)

Used to store the changes made in Edit mode. Upon pressing **Store**, the display will toggle between “st” and a preset number. By using the parameter ▲ or ▼ buttons, select the target storage location, and press **Store** again to complete.

PLAY/TUNER BUTTON (14)

Used to switch back to Play mode if discarding editing changes, activating the chromatic tuner, and deactivating the chromatic tuner.

MAIN DISPLAY (15)

The LED segments in the display show the current bank/preset when in Play mode or the parameter value being adjusted when in Edit mode. Also included are LEDs that indicate if the presets are editable User or non-editable Factory Presets, as well as DSP headroom. If the clip LED indicator occasionally blinks, this indicates 6 dB of DSP headroom remaining before clipping. If the LED is constant, the DSP is probably being clipped. If the tuner is activated, the note that the guitar’s pitch is closest to will be displayed in the display, while the bottom row of the effects matrix LEDs will indicate how flat or sharp the note is.

EDIT ▲ / ► SCROLL BUTTONS (16)

Used to scroll through the editable parameters for each effect. To edit, press either the ▲ or ► scroll button; this switches the DSP into Edit mode. Then edit the effects by pressing the Right scroll button to select the effect to edit, pressing the Up scroll button to scroll through the parameters, and using the parameter ▲ or ▼ buttons to adjust the parameter’s value.

EFFECTS MATRIX LED’S (17)

The LED matrix indicates which effects are active within a preset when in Play mode, and which effect and parameter is being modified when in Edit mode. If the tuner is activated, the bottom row of effects matrix LEDs will indicate how flat or sharp the note is, while the main display will indicate the note that the guitar’s pitch is closest to.

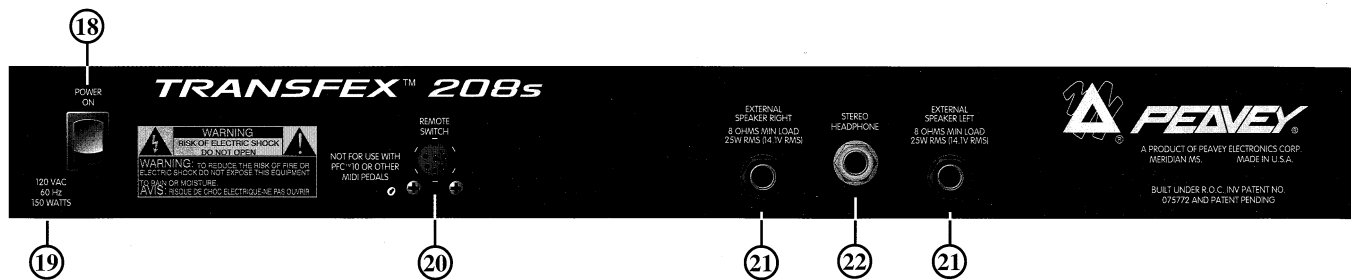

THE BACK PANEL

POWER SWITCH (18)

Depress the switch to the “on” position. The red pilot light (LED) will illuminate, indicating power is being supplied to the unit.

LINE CORD (19)

(120V units only) For your safety, we have incorporated a three-wire line (mains) cable with proper grounding facilities. It is not advisable to remove the ground pin under any circumstances. If it is necessary to use the amp without proper grounding facilities, suitable grounding adaptors should be used. A greatly reduced shock hazard exists when the unit is operated with the proper grounded receptacles.

REMOTE FOOTSWITCH JACK (20)

Used for connection of included remote footswitch for remote selection of presets. Switches include A/B, C bypass, Bank Up, and Bank Down. A/B switch alternately selects patch A or B. C bypass selects patch C and overrides the setting of A/B switch. Bank Up and Bank Down scroll through the banks 0-9. If the bank is incremented above 9 using the footswitch, it will go to the 0 bank within the User or Factory set of patches. This remote footswitch jack will not work with PFC 10 MIDI pedal or any other MIDI pedals. The footswitch should be connected before the unit is turned on.

EXTERNAL SPEAKER JACKS (21)

Provided for connection of external speaker cabinet. Minimum total impedance is 8 ohms per channel. Disconnects internal speaker when used.

STEREO HEADPHONE JACK (22)

Provided for use with any stereo headset. This provides the same left and right outputs as the internal speakers, with frequency compensation to simulate the speaker’s tone. The internal speakers are automatically disconnected when the headphone jack is in use.

Play Mode

Selecting Presets/Basic Functions:

Whenever the TransFex 208s is powered up, it automatically goes into Play mode. When in Play mode, the main LED display on the TransFex 208s reads the current patch number. On power-up, the selected preset will be **0.A**, which is user-modifiable preset **A** of bank **0**. The presets are arranged in 20 banks (0-9 of user and 0-9 of factory banks) of 3 patches (A,B, and C) per bank for a total of 60 presets. If the decimal point between the 0 and A is lit, this signifies that the preset is in the user bank — otherwise the patch is a factory patch. To change from factory to user preset banks, simply scroll through the patches using the parameter **▲** or **▼** buttons, and it will wrap around to the other banks.

The user presets come from the factory set the same as the factory presets, and can be returned to this state by powering up the TransFex 208s with both the **Store** and **Channel Select** buttons held down. The display will read **Fr**, indicating that the user presets were restored to original factory settings.

The previously stored presets simultaneously select two things: a channel selection between the Clean and Lead channel, and an effects selection. The channel selection will be indicated by the LEDs in each channel block. Any preset can call up either channel — i.e. they can all be clean, all dirty, some of each, whatever you want. The effects section is a multi-effect unit which allows any or all of the 6 effects slots to be active. Each one of these effects is fully programmable, and can be tailored for each preset. Some even allow selection of alternate effects types (Chorus/Flanger and Tremolo/Phaser, for example). This system allows for many sonic possibilities and tonal flexibility. For a complete description of each effect and its parameters, see the section titled **Individual Effects/Parameters**.

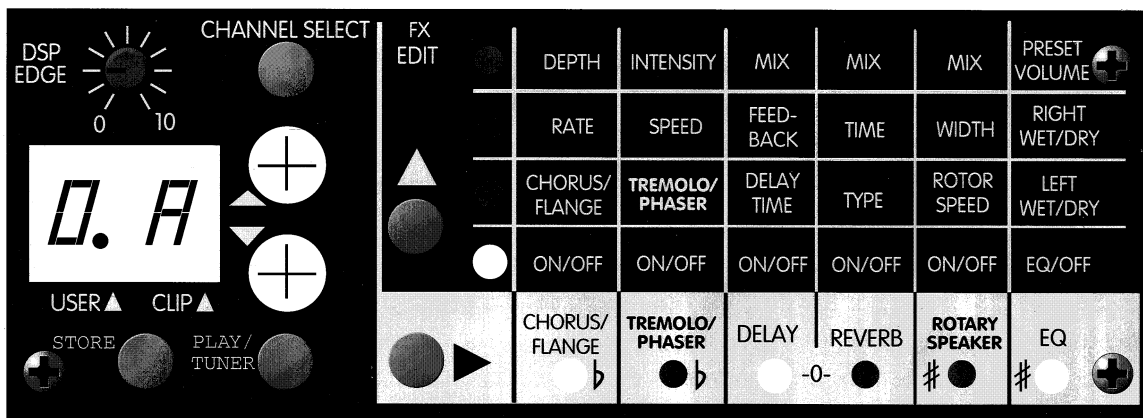

After setting the preamp controls to your liking by following the quick start example, use the parameter **▲** or **▼** buttons to step through the presets. Alternately, the footswitch can also be used to select the various presets. The footswitch should always be connected with the amp powered down, so that its LEDs can be synchronized to the amp's main preset display at start-up. If it is connected or removed with the amp turned on, the preset could change, perhaps resulting in lost editing if done while editing a patch. The footswitch includes bank **▲** or **▼** buttons, in combination with an **A/B** button that selects between A and B patches, and a **C override** button that overrides the A/B settings and switches to C. If either the footswitch or the parameter switches are used, the other will

reflect the same changes. One important difference in using the footswitch, however, is that unlike the parameter buttons, the footswitch will not scroll from user presets to factory presets or vice versa. If the amp is on a factory preset, and you want to switch to a user preset, you must first select the user preset bank via the parameter buttons. This allows the user to wrap around through the user presets (from 9.C back to 0.A), which is the most typical application of footswitch use.

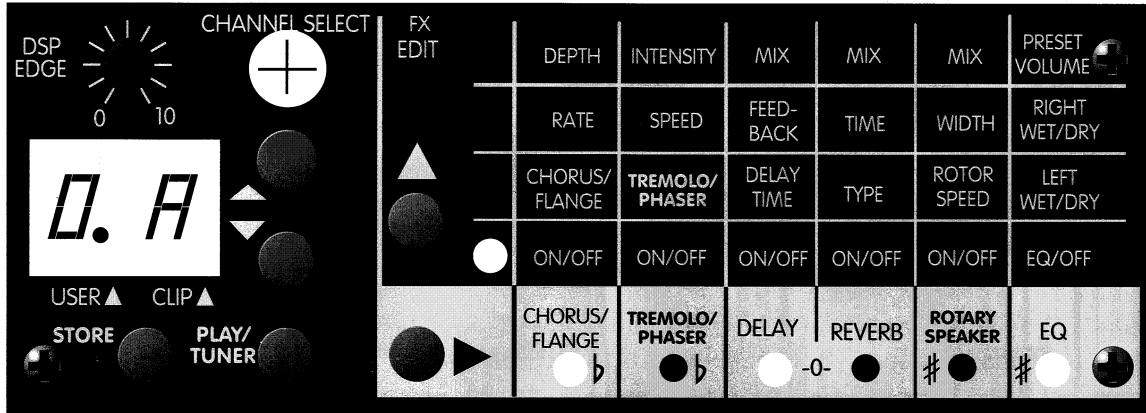

At any time, the **Channel Select** button can be used to change the selected preamp channel from Clean to Lead, or vice versa. This can be very useful when trying patches in different modes. If you change to the next preset without storing this change, the channel selection change you made will simply be ignored.

Various LED Functions:

Main LED display:

The main LED display indicates the preset number when in Play mode, the parameter being modified when in Edit mode, and the note being played when in Tuner mode. As previously indicated, the center decimal point in the main LED display indicates whether the bank is set to the user or factory bank of presets. The right decimal point in the main LED display will illuminate, indicating that the DSP (Digital Signal Processor) is close to clipping. For the quietest operation, set the preamp volumes and effect preset levels so that this indicator flickers occasionally, (i.e. set the preamp volume controls so the light flickers and use the preset volume control to set the “volume” to taste). However, for the cleanest operation, avoid settings where this light stays on constantly.

Channel LEDs:

The channel that is active will have the LED illuminated that is within its control area. The LEDs are different colors — green for Clean and red for Lead — to allow for easier distinction when viewing from a distance.

Effects LED Matrix:

When in Edit mode, the Effects LED matrix on the far right of the amplifier is used to indicate which effect and which parameter is being edited. If the tuner is activated, the bottom row of LEDs indicates how sharp or how flat the note is. When in Play mode, the LED matrix indicates which effects are active. This way it is easier to identify the preset at a glance.

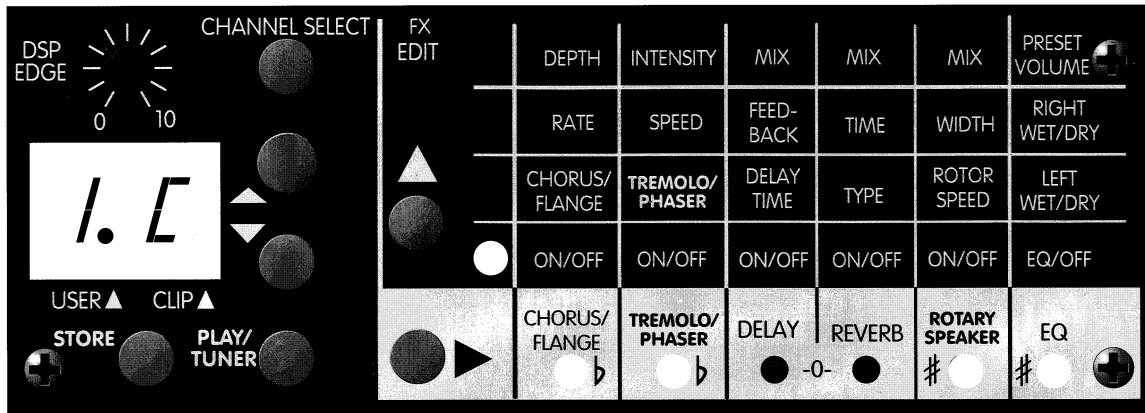

This particular display indicates the amp is set to User patch 1.C, and the following effects are active: Chorus/Flange, Tremolo/Phaser, Rotary Speaker, and EQ.

Footswitch LEDs:

The LEDs on the footswitch show which preset is selected: A, B, or C. This works as follows: If the C LED is off, the setting will be A or B — depending on which is lit. To change between A and B, simply press the A/B switch. To switch to C, press the **C override** button, which overrides the setting of the A/B switch — when the C LED is lit, the preset is on C — regardless of the A/B setting. To return to A or B, first make sure the appropriate one is lit, then press **C** to return to A or B. This system is great for toggling between two presets, by simply hitting the same button over and over, when jumping in and out of solos, etc.

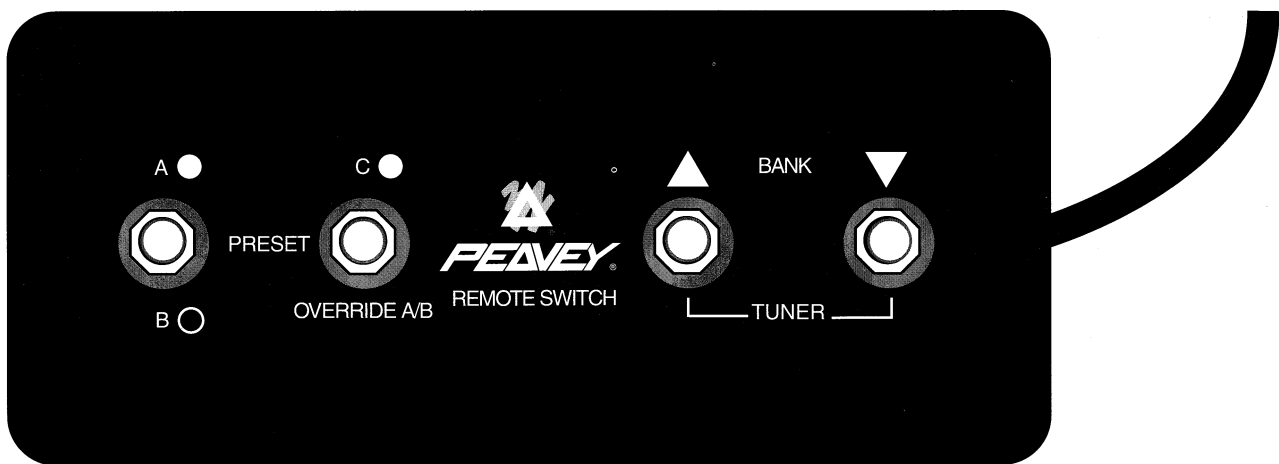

This footswitch displays that the amp is set to preset C, and if the C OVERRIDE button were to be pressed, the amp would switch to preset A.

Tuner Mode:

If the **Play/Tuner** button is pressed while in Play mode, the TransFex 208s will switch to Tuner mode. The tuner may also be accessed from the footswitch by pressing the bank ▲ or ▼ buttons simultaneously. To return to the previous preset press the ▲ or ▼ buttons on the amp or any of the four footswitch buttons. The **Channel Select** button can be used to select between the Clean channel or muted output. This selection will remain in memory until altered. The tuner is a full chromatic one, with LEDs indicating how flat or how sharp the note is. When the note is in tune, both of the center LEDs will illuminate.

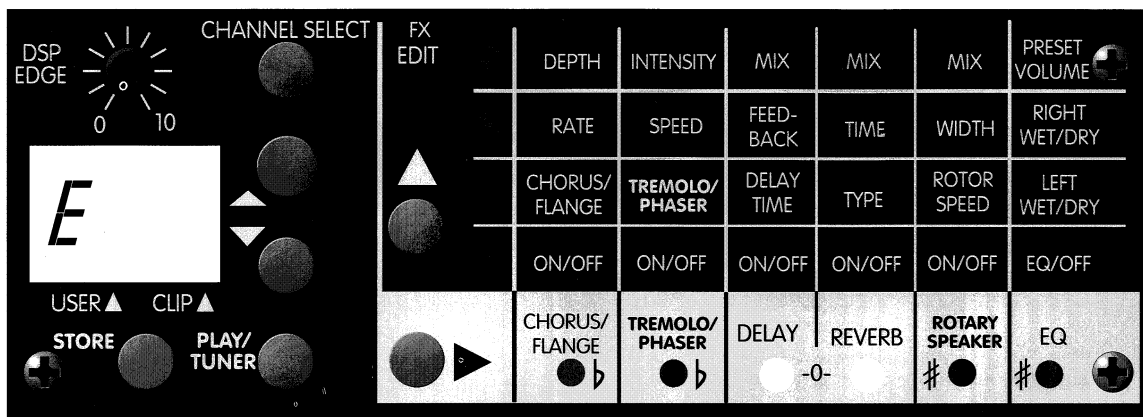

Since the tuner is a full chromatic tuner rather than dedicated to EADGBE tuning, you can detune the whole instrument simply by tuning to whatever notes you desire (for example, you could tune down 1/2 step to Eb — EbAbDbGbBbEb, open A tuning — EAEAC#E, drop D tuning — DADGBE, etc.).

To return to Play mode, simply press the **Play/Tuner** button and the amp will return to Play mode in the last preset used before selecting Tuner mode.

The DSP Edge Control:

The **DSP edge** control globally adjusts the high end of the delay and reverb tails. This can be very useful when trying to simulate an analog or tape delay, where the tape system couldn't play back with digital fidelity — the highs were rolled off — and successive repeats had less and less highs. By adjusting this control to lower settings, the resulting delays will sound warmer — more “analog”. By adjusting this control to higher settings, the resulting delays will sound brighter — more “digital”.

The digital reverb is also tailored by the setting of the **DSP edge** control. For more modern sounding, brighter reverbs, the control should be set higher. To more closely approximate a spring reverb, set the control lower.

Additional equalization for the delays and reverbs can be obtained by using the programmable EQ, with the delays and reverbs mixed 100% wet, and using the master L and R mix controls to set the mix. This technique allows for the creation of many different sounding reverb effects.

Edit Mode

Getting Into Edit Mode:

Editing presets and parameters on the TransFex 208s is very simple. After using the parameter ▲ or ▼ buttons to select the preset you wish to edit, the next step in editing presets on the TransFex 208s is to put the effects system into Edit mode. This is accomplished by pressing either the ▲ or ► **FX EDIT** button. After doing so, the Chorus/Flanger LED will start to blink. To discard the edited changes at any time during the editing process, simply press Play or change the preset using the footswitch.

Selecting Effects to Edit:

For the purpose of demonstrating this, let's edit preset **2.b**. It currently contains a delay, reverb, and a digital EQ. We'll add a tremolo, delete the delay, and select a different EQ. Use the parameter ▲ or ▼ buttons to select preset **2.b**.

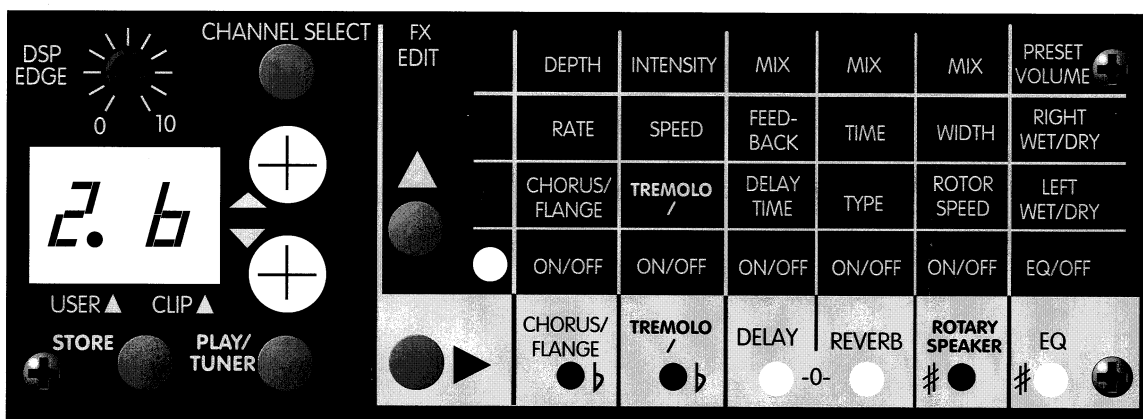

Select the effect you wish to add, delete, or edit using the ► **FX EDIT** button. As the **FX EDIT** buttons are pressed, the vertical column of LEDs will show which parameter is being edited, while the lower row of LEDs will show which effect is being edited. As you scroll through the various effects, the main LED display will indicate whether the effect is **on** or **off**. Use the parameter ▲ or ▼ buttons to turn the tremolo effect on.

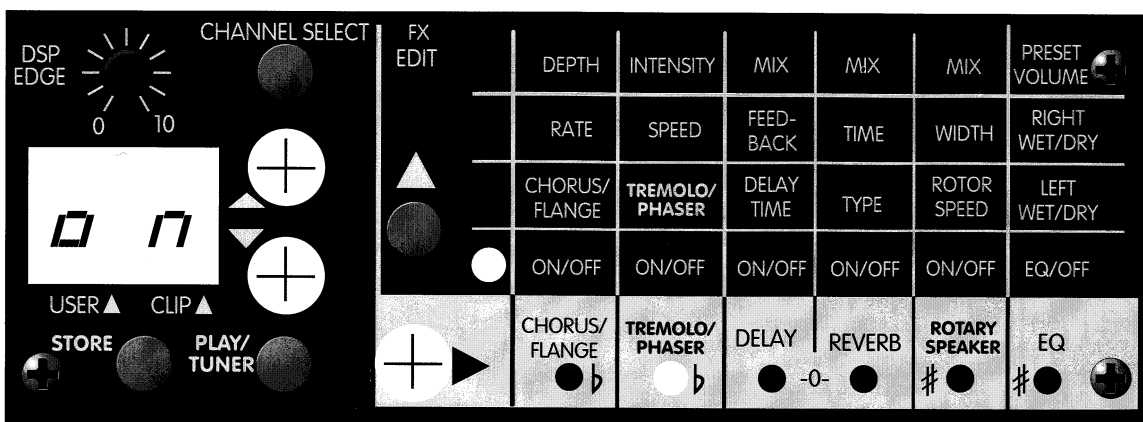

Changing Parameters:

Now use the **▲ FX EDIT** button to select which parameter you wish to edit. The main display will show the current value that the parameter is set to. To adjust the parameter, use the parameter **▲** or **▼** buttons. First, select the Tremolo/Phaser parameter and note that it is already set to tremolo (changing the parameter buttons would change this parameter to phaser).

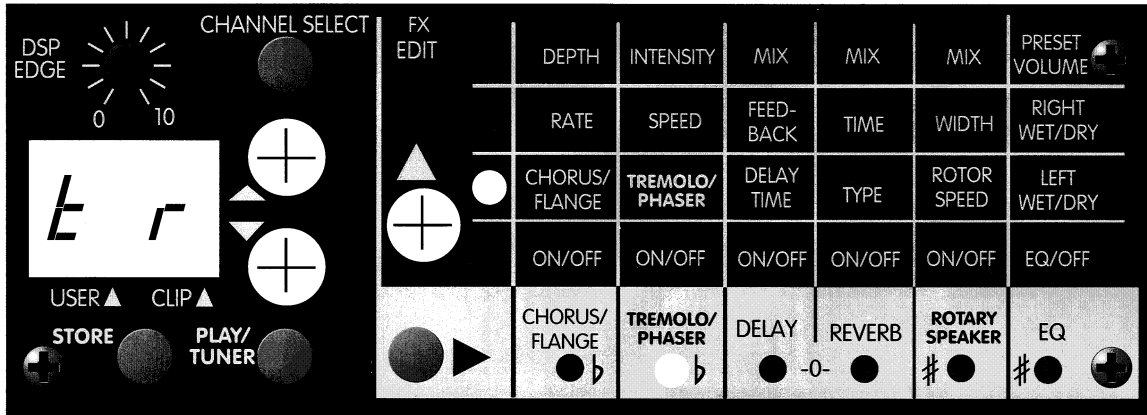

Now use the **▲ FX EDIT** button again to select the speed parameter and use the parameter **▲** or **▼** buttons to set it to 25. Note that if the parameter **▲** or **▼** button is held down, it will scroll to the desired value.

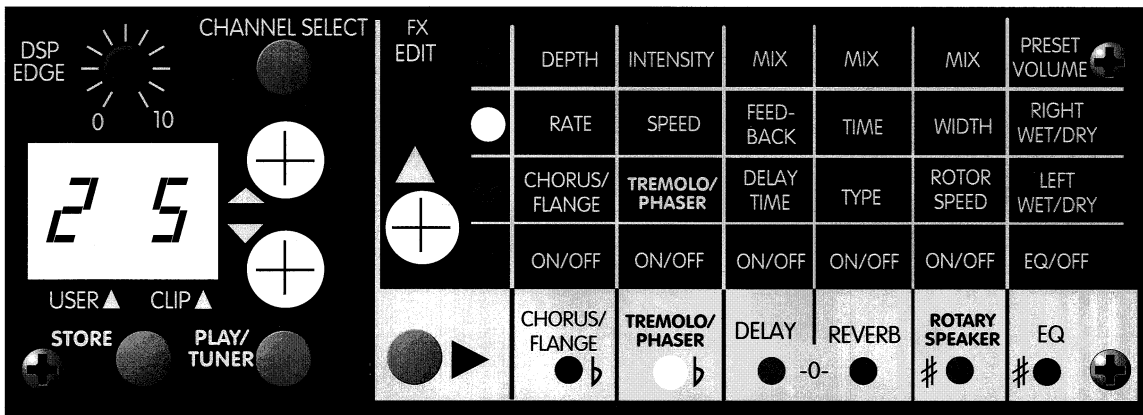

Now use the **▲ FX EDIT** button again to select the intensity parameter and use the parameter **▲** or **▼** buttons to set it to 85.

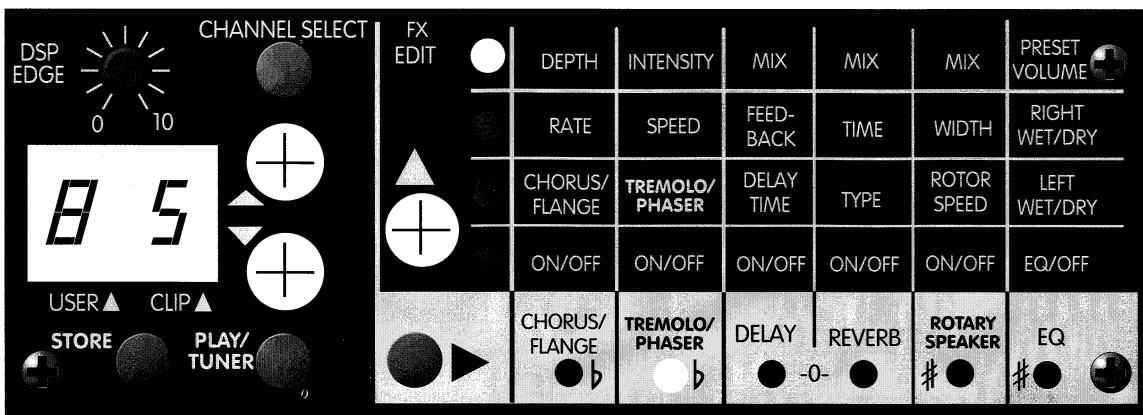

Next use the ► **FX EDIT** button to select the delay effect, and use the parameter ▲ or ▼ to turn it "of". Once the effect is turned off, it isn't necessary to "zero out" the parameters. However, there is one exception; on the Rotary Speaker effect, the speed settings from the previously used preset will determine the initial speed of the rotor. Therefore, if you want the rotary speaker to ramp up to a fast speed when initially selected, simply program the speed to slow on patches that have it turned off.

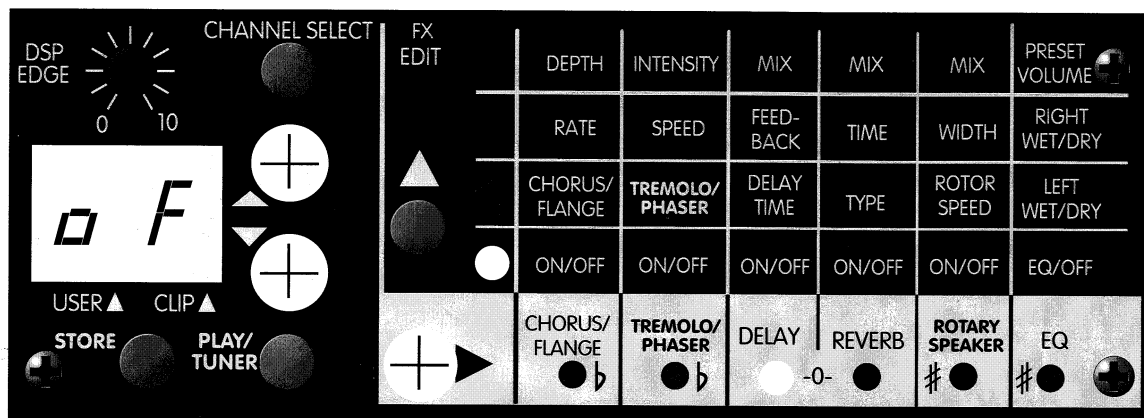

Use the ► **FX EDIT** button again to select the EQ effect. It's currently set to **br** (bright), but let's change it to **CL** (clean).

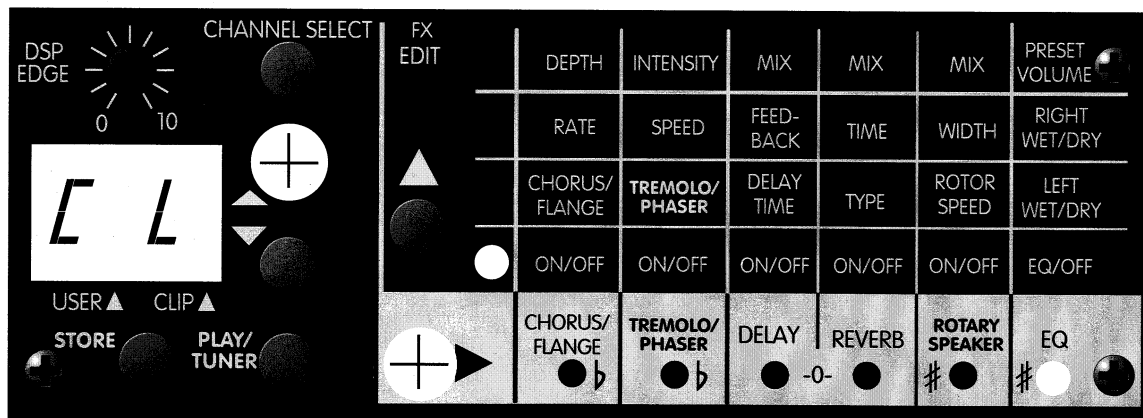

Individual Effects/Parameters

Chorus

The stereo Chorus effect mixes a delayed signal to the dry, while modulating the delay time, which periodically changes the interval of pitch shift. This yields a pleasing stereo effect that sounds like several voices at once with slight variations in pitch.

Parameters

On/Off: The **On/Off** parameter determines whether the Chorus/Flanger effect is activated.

Chorus/Flanger: The **Chorus/Flanger** parameter determines which effect is selected, the Chorus(Ch) or Flanger(FL).

Rate: The **Rate** parameter adjusts the speed that the delay is modulated. It can be varied from **0 - 99**, which represents speeds from 0 to 9.9 Hz in 0.1 Hz intervals. This range is somewhat higher than most stomp box chorus pedals, so some very interesting effects can be created.

Depth: The **Depth** control adjusts the amount of variation of delay time that is applied to the delay. The **0 - 99** range should be used with taste, and is generally decreased when increasing the Rate control.

Cool Setting:

Rate: 4

Depth: 50

Flanger

The Flanger originated from the recording technique called “flanging” in which the recording engineer would rest his hand on the “flange” of the tape reel. By varying the pressure applied, the tape speed was varied, and the pitch modulated. Electronic versions from the 70’s also included feedback systems to increase the intensity of the effect and thus created the classic Flanger effect.

Parameters

On/Off: The **On/Off** parameter determines whether the Chorus/Flanger effect is activated.

Chorus/Flanger: The **Chorus/Flanger** parameter determines which effect is selected, the Chorus(Ch) or Flanger(FL).

Rate: As in the chorus effect, the **Rate** parameter adjusts the speed that the delay is modulated. It can be varied from **0 - 99** (0 to 9.9 Hz in 0.1 Hz steps), although this range is somewhat higher than most stomp box flanger pedals.

Depth: The **Depth** control adjusts the amount of variation of delay time that is applied to the delay. The **0 - 99** range should be used with taste, and is generally decreased when increasing the Rate control. Because of the internal feedback systems and the smaller delay time, decreasing the Depth control to 0 will still yield a flanging sound. To reduce the flange effect, the output wet/dry mixes can be utilized.

Cool Setting:

Rate: 4
Depth: 80

Tremolo

The tremolo was one of the first on-board effects to show up in guitar amplifiers. This version of tremolo uses a special modulation waveform to accurately emulate the vintage guitar amp tremolos of the 60's — like turning the volume of the guitar up and down in a somewhat jerky fashion.

Parameters

On/Off: The **On/Off** parameter determines whether the Tremolo/Phaser effect is activated.

Tremolo/Phaser: The **Tremolo/Phaser** parameter determines which effect is selected, Tremolo(tr) or Phaser(Ph).

Speed: The **Speed** parameter adjusts the rate at which the volume is modulated. It can be varied from **0 - 99**, and allows for control very similar to that found in vintage guitar amps. The speed is calibrated in 0.1 Hz intervals from 0 to 9.9 Hz.

Intensity: The **Intensity** control adjusts the amount of volume reduction obtained by the tremolo effect. The range of **0 - 99** adjusts the intensity from no effect to full volume cut — i.e. the sound is turned completely off as it modulates.

Cool Setting:

Speed: 40
Intensity: 60

Phaser

The classic phaser, or phase shifter, is one of the most commonly recorded guitar effects of the 70's. This effect modulates the phase shift amount of a signal and sums it back to the dry signal.

Parameters

On/Off: The **On/Off** parameter determines whether the Tremolo/Phaser effect is activated.

Tremolo/Phaser: The **Tremolo/Phaser** parameter determines which effect is selected, the Tremolo(tr) or Phaser(Ph).

Speed: The **Speed** parameter adjusts the rate at which the phase shift is modulated. It can be varied from **0 - 99** although this range is somewhat higher than most stomp box phasers.

Intensity: The **Intensity** control adjusts a feedback loop in the phase shifter to allow for a higher frequency, and more resonant whistle. This isn't like a depth control on a chorus where the depth at 0 means no effect — just try it. The **0-99** range sounds the most normal when set around 50, and sounds like more elaborate phase shifters with color switches, etc., when set to around 99.

Cool Settings:

Speed: 23

Intensity: 60

Delay

This delay effect is a tapped delay, consisting of left and right delay lines separated by 20 mS delay time. It includes parameters for delay time, feedback, and wet/dry mix and is affected by the global setting of the DSP Edge control. This control allows for simulation of tape or analog echos by changing the amount of highs in the delay line.

Parameters

On/Off: The **On/Off** parameter determines whether the Delay effect is activated.

Delay Time: The **Delay Time** parameter sets the amount of time between the dry and delayed signals. If adjacent presets use different delay times, and the delay effect is “on”, the delay will simply change to the new time without stopping the repeats. The range is **0 - 87** and represents delay times of 0 to 870 mS in 10 mS intervals.

Feedback: The **Feedback** parameter affects the number of repeats that the delay will produce. The range is **0 - 99**, with 0 representing a single echo, or slap-back delay, and 99 yielding almost infinite repeats. When changing between presets containing delay, the delays will continue repeating after changing to the new delay times and feedback settings. If the delay is turned off on the newly selected preset, the delays will stop.

Mix: The **Mix** parameter allows mixing between wet and dry. For maximum delay level and minimum dry level, adjust this parameter to 99. A setting of 0 will result in only dry signal passing through.

Cool Setting:

Delay Time: 25

Feedback: 30

Mix: 30

Reverb

Probably the most important guitar effect of all time, the inclusion of reverb on vintage amplifiers not only added a warmth to the guitar tones of the day — it also virtually created the genre of music known as surf music. This reverb effect uses four possible reverb types — spring, plate, room, and hall — and a reverb time control to simulate many different types of reverbs. The global setting of the **DSP Edge** control can be used to simulate darker caverns, bright rooms, warm spring reverbs, etc. by tailoring the tone of the reverb tails.

Parameters

On/Off: The **On/Off** parameter determines whether the Reverb effect is activated.

Reverb Type: The **Reverb Type** parameter selects one of four possible reverb types. These are spring(**SP**), plate(**PL**), room(**ro**), and hall(**hL**). Each type has different types of delays and different tone settings which, when combined with the time parameter, allow for many variations of reverb settings.

Time: The **Time** parameter affects the length of time that the reverb tails last. The range is **0 - 99**, with 0 representing a very small room, and 99 yielding a huge cavernous amount of reverb.

Mix: The **Mix** parameter allows mixing between wet and dry. For maximum reverb level and minimum dry level, adjust this parameter to 99. A setting of 0 will result in only dry signal passing through.

Cool Setting:

Reverb Type: SP

Time: 40

Mix: 35

Rotary Speaker (RS)

The Rotary Speaker effect is normally thought of as a keyboard effect — however, many classic guitar sounds were actually created by running guitar through a rotary speaker cabinet. This simulation incorporates separate Rotor Speed and Width controls, and when a new preset is recalled, the speed automatically ramps to the new speed — just like a real rotary speaker cabinet.

Parameters

On/Off: The **On/Off** parameter determines whether the Rotary Speaker effect is activated.

Rotor Speed: The **Rotor Speed** parameter sets the speed at which the rotor is “spinning.” If adjacent presets use different rotor speed settings, the speed changes gradually like a real rotary speaker when switching between the presets. A special technique is used to preset the initial value for the rotary speaker’s speed, i.e. whether it will “start at” or “ramp to” the speed setting. If the

previously selected preset had the rotary speaker effect “off”, but was set to a different speed, the speed will ramp to the new speed value when switching to a preset with the rotary speaker effect “on.” The range for speeds is **0 - 99** (0 to 9.9 Hz in .1 Hz steps).

Width: The **Width** parameter affects the amount of pitch shift and stereo panning that the spinning rotor yields. The range is **0 - 99**, and typically sounds best around 75.

Mix: The **Mix** parameter allows mixing between wet and dry. For maximum rotary speaker effect, adjust this parameter to 99. A setting of 0 will result in all dry signal passing through. The mix control is useful for obtaining the sound of an amp used with both a rotary speaker and a normal guitar cabinet.

Cool Setting:

Rotor Speed: 64 (fast) 15 (slow)

Width: 60

Mix: 99

EQ/Master Section

The Master section includes 4 important parameters: the EQ parameter, Left and Right Wet/Dry mixes, and the Preset Volume. These are all preset-dependent parameters (i.e. are saved as part of each preset) and allow for greater flexibility by allowing each preset to contain different volume, mix, and equalization settings.

Parameters

EQ/Off: The **EQ/Off** parameter determines whether the EQ is off, or set to one of 7 preset EQ curves:

Thrash(**th**) — notches the upper mids

Low boost(**Lo**) — boosts the low end and cuts the presence

High boost(**hi**) — boosts the highs

Clean(**CL**) — boosts the presence while slightly reducing the low-mids

Lead(**Ld**) — slightly boosts the mids while slightly reducing the presence

Bass(**bS**) —smiley-face

Bright(**br**) — increased highs with sharply reduced presence

Left Wet/Dry: The **Left Wet/Dry** parameter sets the wet/dry mix for the left output. This is particularly useful if you wish to bypass the effects section on one side while the other side is full wet. Also, this parameter can be used to reduce the effects level without going to each individual effect mix control. The range is **0 - 99**, with full dry at 0 and full wet at 99.

Right Wet/Dry: The **Right Wet/Dry** parameter sets the wet/dry mix for the right output.

Preset Volume: The **Preset Volume** parameter sets the overall output volume of the amplifier for each preset. The range is from **0 - 31**. This can be very useful in setting balances between rhythm and lead sounds while using the same preamp channel. It's a good idea to start with the volumes set around 25 or 26 to allow for increased and decreased volume on each preset. Adjusting this volume will not affect the clip indicator.

SPECIFICATIONS:

POWER AMP SECTION

Rated Power & Load (each channel):

- 30 W RMS into 8 ohms/driven separately
- 25 W RMS into 8 ohms/both channels driven
- (External speaker jacks disconnect internal speakers)

Power @ Clipping: (typically)

- (5% THD, 1 kHz, 120V AC line)
- 25W RMS into 8 ohms/both channels driven

Power Amp Hum & Noise:

- Greater than 75 dB below rated power

Headphone Output (Stereo Jack/Stereo Signal):

- Load Impedance: 8 ohms or greater
- Nominal Power Output: 30 mw RMS into 8 ohms
- Frequency compensated to simulate speaker tone:
- (Switching jack, disconnects internal and external speakers when a stereo plug is fully inserted).

Power Consumption:

- 150 W @ 50/60 Hz, 120 V AC, Domestic
- 150 W @ 60 Hz, 220-230/240 V AC, Export

PREAMP/EFFECTS SECTION

D/A and A/D Conversion

- Rate: 23.44 kHz
- Quantization: 16 bit

The following specs are measured @ 1 kHz with the controls set as follows:

- Low & High EQ @ 10*
- Mid EQ @ 0*
- Lead channel controls @ 0*
- Channel select set to Clean channel*
- Preset Volume programmed @ 31 (Maximum)*
- Wet/Dry mixes set @ 99*
- Programmable EQ of (off)*
- Effects chain with all effects of (off)*

- Nominal Levels are with clean volume @ 5
- Minimum Levels are with clean volume @ 10

Preamp Input (With -10 dB pad OUT):

Impedance: High-Z, 1 M ohm
Nominal Input Level: -18 dBV, 120 mV RMS
Minimum Input Level: -28 dBV, 40 mV RMS
Maximum Input Level: 0 dBV, 1 V RMS

Preamp Input (With -10 dB pad IN):

Impedance: High-Z, 44 k ohm
Nominal Input Level: -12 dBV, 240 mV RMS
Minimum Input Level: -22 dBV, 80 mV RMS
Maximum Input Level: 6 dBV, 2 V RMS

System Hum and Noise:

Greater than 66 dB below rated power

Equalization:

Special low, mid, & high passive type EQ
Push Thrash: -20 dB notch @ 1 kHz in Lead channel
Push Gain: Increases Lead gain

External Footswitch Functions:

A,B, C preset selection with LED indicators
Bank Up and Bank Down buttons
Remote Tuner Access by pressing
Bank Up/Down simultaneously

Dimensions:

- Width: 20 1/4 inches
- Depth: 9 3/8 inches
- Height: 16 1/8 inches
- Weight: 30 lbs.



**Built under U. S. Pat. No. 5,619,578;
R. O. C. Inv. Pat. No. 075772; Pat. Pend.**

Block Diagram TransFex 208s

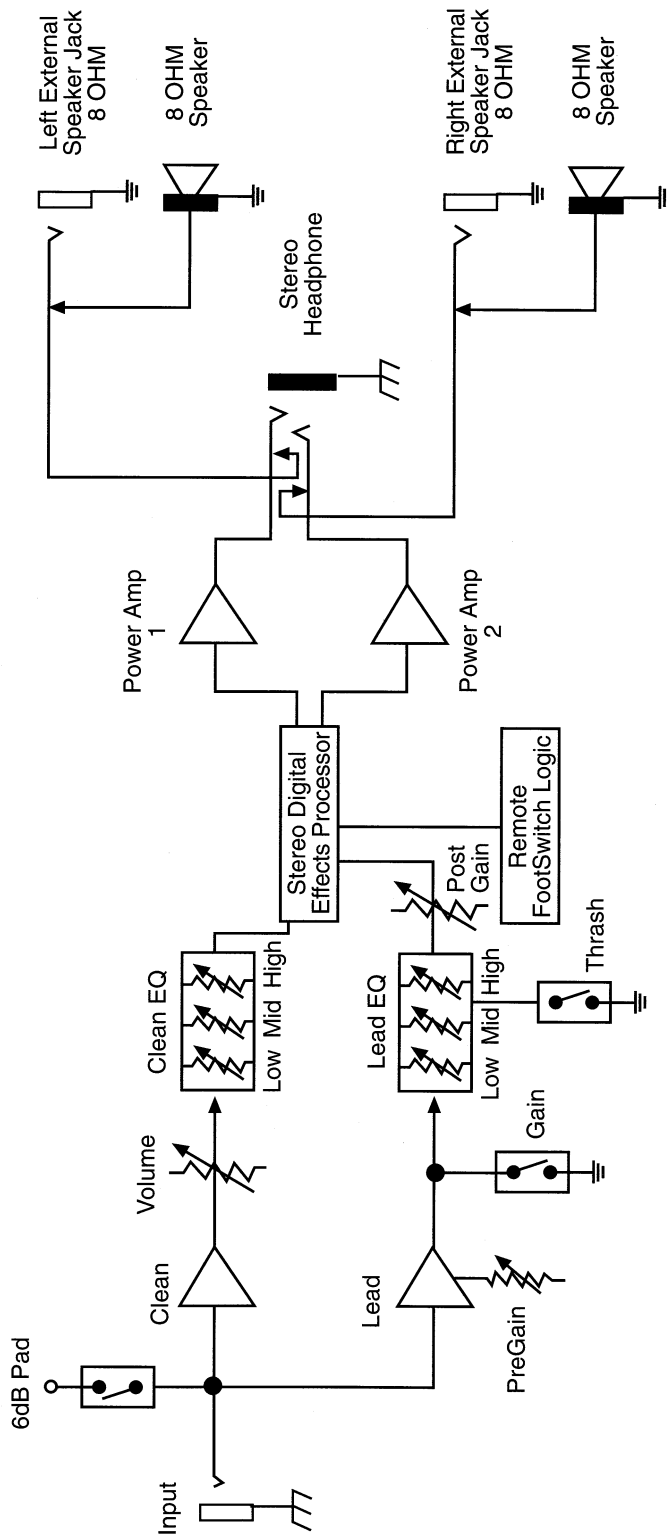

This block diagram shows the signal path within the unit. In order to thoroughly understand the unit's functions, please study the block diagram carefully.

PEAVEY ELECTRONICS CORPORATION LIMITED WARRANTY

Effective Date: July 1, 1998

What This Warranty Covers

Your Peavey Warranty covers defects in material and workmanship in Peavey products purchased and serviced in the U.S.A. and Canada.

What This Warranty Does Not Cover

The Warranty does not cover: (1) damage caused by accident, misuse, abuse, improper installation or operation, rental, product modification or neglect; (2) damage occurring during shipment; (3) damage caused by repair or service performed by persons not authorized by Peavey; (4) products on which the serial number has been altered, defaced or removed; (5) products not purchased from an Authorized Peavey Dealer.

Who This Warranty Protects

This Warranty protects only the original retail purchaser of the product.

How Long This Warranty Lasts

The Warranty begins on the date of purchase by the original retail purchaser. The duration of the Warranty is as follows:

Product Category	Duration
Guitars/Basses, Amplifiers, Pre-Amplifiers, Mixers, Electronic Crossovers and Equalizers	2 years *(+ 3 years)
Drums	2 years *(+ 1 year)
Enclosures	3 years *(+ 2 years)
Digital Effect Devices and Keyboard and MIDI Controllers	1 year *(+ 1 year)
Microphones	2 years
Speaker Components (incl. speakers, baskets, drivers, diaphragm replacement kits and passive crossovers) and all Accessories	1 year
Tubes and Meters	90 days

[*denotes additional warranty period applicable if optional Warranty Registration Card is completed and returned to Peavey by original retail purchaser within 90 days of purchase.]

What Peavey Will Do

We will repair or replace (at Peavey's discretion) products covered by warranty at no charge for labor or materials. If the product or component must be shipped to Peavey for warranty service, the consumer must pay initial shipping charges. If the repairs are covered by warranty, Peavey will pay the return shipping charges.

How To Get Warranty Service

(1) Take the defective item and your sales receipt or other proof of date of purchase to your Authorized Peavey Dealer or Authorized Peavey Service Center.

OR

(2) Ship the defective item, prepaid, to Peavey Electronics Corporation, International Service Center, 412 Highway 11 & 80 East, Meridian, MS 39301 or Peavey Canada Ltd., 95 Shields Court, Markham, Ontario, Canada L3R 9T5. Include a detailed description of the problem, together with a copy of your sales receipt or other proof of date of purchase as evidence of warranty coverage. Also provide a complete return address.

Limitation of Implied Warranties

ANY IMPLIED WARRANTIES, INCLUDING WARRANTIES OF MERCHANTABILITY AND FITNESS FOR A PARTICULAR PURPOSE, ARE LIMITED IN DURATION TO THE LENGTH OF THIS WARRANTY.

Some states do not allow limitations on how long an implied warranty lasts, so the above limitation may not apply to you.

Exclusions of Damages

PEAVEY'S LIABILITY FOR ANY DEFECTIVE PRODUCT IS LIMITED TO THE REPAIR OR REPLACEMENT OF THE PRODUCT, AT PEAVEY'S OPTION. IF WE ELECT TO REPLACE THE PRODUCT, THE REPLACEMENT MAY BE A RECONDITIONED UNIT. PEAVEY SHALL NOT BE LIABLE FOR DAMAGES BASED ON INCONVENIENCE, LOSS OF USE, LOST PROFITS, LOST SAVINGS, DAMAGE TO ANY OTHER EQUIPMENT OR OTHER ITEMS AT THE SITE OF USE, OR ANY OTHER DAMAGES WHETHER INCIDENTAL, CONSEQUENTIAL OR OTHERWISE, EVEN IF PEAVEY HAS BEEN ADVISED OF THE POSSIBILITY OF SUCH DAMAGES

Some states do not allow the exclusion or limitation of incidental or consequential damages, so the above limitation or exclusion may not apply to you.

This Warranty gives you specific legal rights, and you may also have other rights which vary from state to state.

If you have any questions about this warranty or service received or if you need assistance in locating an Authorized Service Center, please contact the Peavey International Service Center at (601) 483-5365 / Peavey Canada Ltd. at (905) 475-2578.

Features and specifications subject to change without notice.

#80304545

VISIT US ON THE WEB www.peavey.com

Peavey Electronics Corporation • 711 A Street • Meridian, MS 39301 • U.S.A. • (601) 483-5365 • Fax (601) 486-1278
Peavey Europe • Great Folds Road • Oakley Hay • CORBY • Northants NN18 9ET • England
Tel: +44 (0) 1536 461234 • Fax: +44 (0) 1536 747222 • ©1998



PEAVEY

IMPORTANT SAFETY INSTRUCTIONS

WARNING: When using electric products, basic cautions should always be followed, including the following.

1. Read all safety and operating instructions before using this product.
2. All safety and operating instructions should be retained for future reference.
3. Obey all cautions in the operating instructions and on the back of the unit.
4. All operating instructions should be followed.
5. This product should not be used near water, i.e., a bathtub, sink, swimming pool, wet basement, etc.
6. This product should be located so that its position does not interfere with its proper ventilation. It should not be placed flat against a wall or placed in a built-in enclosure that will impede the flow of cooling air.
7. This product should not be placed near a source of heat such as a stove, radiator, or another heat producing amplifier.
8. Connect only to a power supply of the type marked on the unit adjacent to the power supply cord.
9. Never break off the ground pin on the power supply cord. For more information on grounding, write for our free booklet "Shock Hazard and Grounding."
10. Power supply cords should always be handled carefully. Never walk or place equipment on power supply cords. Periodically check cords for cuts or signs of stress, especially at the plug and the point where the cord exits the unit.
11. The power supply cord should be unplugged when the unit is to be unused for long periods of time.
12. If this product is to be mounted in an equipment rack, rear support should be provided.
13. Metal parts can be cleaned with a damp rag. The vinyl covering used on some units can be cleaned with a damp rag or an ammonia-based household cleaner if necessary. Disconnect unit from power supply before cleaning.
14. Care should be taken so that objects do not fall and liquids are not spilled into the unit through the ventilation holes or any other openings.
15. This unit should be checked by a qualified service technician if:
 - a. The power supply cord or plug has been damaged.
 - b. Anything has fallen or been spilled into the unit.
 - c. The unit does not operate correctly.
 - d. The unit has been dropped or the enclosure damaged.
16. The user should not attempt to service this equipment. All service work should be done by a qualified service technician.
17. This product should be used only with a cart or stand that is recommended by Peavey Electronics.
18. Exposure to extremely high noise levels may cause a permanent hearing loss. Individuals vary considerably in susceptibility to noise induced hearing loss, but nearly everyone will lose some hearing if exposed to sufficiently intense noise for a sufficient time. The U.S. Government's Occupational Safety and Health Administration (OSHA) has specified the following permissible noise level exposures.

Duration Per Day In Hours	Sound Level dBA, Slow Response
8	90
6	92
4	95
3	97
2	100
1 1/2	102
1	105
1/2	110
1/4 or less	115

According to OSHA, any exposure in excess of the above permissible limits could result in some hearing loss.

Ear plugs or protectors in the ear canals or over the ears must be worn when operating this amplification system in order to prevent a permanent hearing loss if exposure is in excess of the limits as set forth above. To ensure against potentially dangerous exposure to high sound pressure levels, it is recommended that all persons exposed to equipment capable of producing high sound pressure levels such as this amplification system be protected by hearing protectors while this unit is in operation.

SAVE THESE INSTRUCTIONS!



Features and specifications subject to change without notice.

Peavey Electronics Corporation 711 A Street / Meridian, MS 39301 / U.S.A. / (601) 483-5376 / Fax 486-1154



80301026

©1997

Printed in U.S.A. 7/97

Free Manuals Download Website

<http://myh66.com>

<http://usermanuals.us>

<http://www.somanuals.com>

<http://www.4manuals.cc>

<http://www.manual-lib.com>

<http://www.404manual.com>

<http://www.luxmanual.com>

<http://aubethermostatmanual.com>

Golf course search by state

<http://golfingnear.com>

Email search by domain

<http://emailbydomain.com>

Auto manuals search

<http://auto.somanuals.com>

TV manuals search

<http://tv.somanuals.com>