

BLAZER™ 158

GUITAR AMPLIFIER

OPERATING GUIDE





Intended to alert the user to the presence of uninsulated “dangerous voltage” within the product’s enclosure that may be of sufficient magnitude to constitute a risk of electric shock to persons.



Intended to alert the user to the presence of important operating and maintenance (servicing) instructions in the literature accompanying the product.

CAUTION Risks of electrical shock — DO NOT OPEN

CAUTION To reduce the risk of electric shock, do not remove cover. No user serviceable parts inside. Refer Servicing to qualified service personnel.

WARNING To prevent electrical shock or fire hazard, do not expose this appliance to rain or moisture. Before using this appliance, read the operating guide for further warnings.



Este símbolo tiene el propósito de alertar al usuario de la presencia de instrucciones importantes sobre la operación y mantenimiento en la literatura que viene con el producto.



Este símbolo tiene el propósito de alertar al usuario de la presencia de “(voltaje) peligroso” que no tiene aislamiento dentro de la caja del producto que puede tener una magnitud suficiente como para constituir riesgo de corrientazo.

PRECAUCION Riesgo de corrientazo - No abra.

PRECAUCION Para disminuir el riesgo de corrientazo, no abra la cubierta. No hay piezas adentro que el usuario pueda reparar. Deje todo mantenimiento a los técnicos calificados.

ADVERTENCIA Para evitar corrientazos o peligro de incendio, no deje expuesto a la lluvia o humedad este aparato. Antes de usar este aparato, lea más advertencias en la guía de operación.



Ce symbole est utilisé pour indiquer à l'utilisateur qu'il ou qu'elle trouvera d'importantes instructions sur l'utilisation et l'entretien (service) de l'appareil dans la littérature accompagnant le produit.



Ce symbole est utilisé pour indiquer à l'utilisateur la présence à l'intérieur de ce produit de tension non-isolée dangereuse pouvant être d'intensité suffisante pour constituer un risque de choc électrique.

ATTENTION Risques de choc électrique — NE PAS OUVRIR!

ATTENTION Afin de réduire le risque de choc électrique, ne pas enlever le couvercle. Il ne se trouve à l'intérieur aucune pièce pouvant être réparée par l'utilisateur. Confier l'entretien à un personnel qualifié.

AVERTISSEMENT Afin de prévenir les risques de décharge électrique ou de feu, n'exposez pas cet appareil à la pluie ou à l'humidité. Avant d'utiliser cet appareil, lisez les avertissements supplémentaires situés dans le guide d'utilisation.



Dieses Symbol soll den Benutzer auf wichtige Instruktionen in der Bedienungsanleitung aufmerksam machen, die Handhabung und Wartung des Produkts betreffen.



Dieses Symbol soll den Anwender vor unisolierten gefährlichen Spannungen innerhalb des Gehäuses warnen, die von Ausreichender Stärke sind, um einen elektrischen Schlag verursachen zu können.

VORSICHT Risiko - Elektrischer Schlag! Nicht öffnen!

VORSICHT Um das Risiko eines elektrischen Schlages zu vermeiden, nicht die Abdeckung entfernen. Es befinden sich keine Teile darin, die vom Anwender repariert werden könnten. Reparaturen nur von qualifiziertem Fachpersonal durchführen lassen.

ACHTUNG Um einen elektrischen Schlag oder Feuergefahr zu vermeiden, sollte dieses Gerät nicht dem Regen oder Feuchtigkeit ausgesetzt werden. Vor Inbetriebnahme unbedingt die Bedienungsanleitung lesen.

ENGLISH

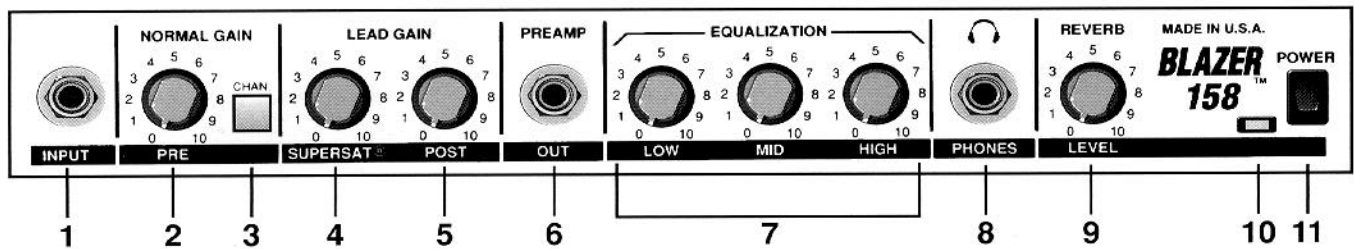

INPUT (1)

The input jack will accept signals from all types of guitar pickups. Be sure to use a high-quality shielded cable to connect the guitar to the amplifier.

PRE (2)

Controls the volume level of the Normal channel and is not affected by the SuperSat[®] or Post Gain controls.

CHANNEL SELECT SWITCH (3)

Allows selection of the Lead or Normal channel. The “in” position of the switch selects the Lead channel and the “out” position select Normal.

SUPERSAT[®] (4)

A transistor simulation of tube distortion (soft clipping). To activate the SuperSat effect, Lead channel must be activated.

POST GAIN (5)

Controls the overall volume level of the Lead channel. The final level adjustment should be made after the desired sound has been achieved.

PREAMP OUT (6)

The preamp output can be used to route the amplified signal to a mixing console, tape recorder, etc. Connect the preamp output using a shielded cable to an input of the tape recorder, mixer, etc. This patch does not affect the operation of the amplifier.

LOW, MID, & HIGH EQ (7)

Passive tone controls that regulate the low, mid and high frequencies, respectively.

HEADPHONE JACK (8)

This stereo jack allows signal to flow to both sides of any stereo headset. A monaural headset may be used, but is not recommended.

REVERB LEVEL (9)

Controls the overall reverb level.



POWER LED (10)

Illuminates when AC power is being supplied to the amp.

POWER SWITCH (11)

Depress the switch to the “On” position. The red pilot light (LED) will illuminate indicating power is being supplied to the unit.









WARNING: This unit is connected to the mains power, even if the power switch is off.

<p>15 WATTS 7.7V RMS 4 OHMS</p> <p>120 VAC 60 Hz 40 WATTS</p>	<p>CAUTION RISK OF ELECTRIC SHOCK DO NOT OPEN</p> <p>WARNING TO REDUCE THE RISK OF FIRE OR ELECTRIC SHOCK DO NOT EXPOSE THIS EQUIPMENT TO RAIN OR MOISTURE. AVIS: RISQUE DE CHOC ELECTRIQUE-NE PAS OUVRIIR.</p>			<p>A PRODUCT OF PEAVEY ELECTRONICS CORP. MERIDIAN, MS. MADE IN U.S.A. BUILT UNDER U.S. PATENT NO. 4,811,401; R.O.C. UTILITY MODEL. PATENT NO 51009; KOREA PATENT NO. 40007; AND PATENT PENDING</p>
---	---	---	---	--

CAUTION: To prevent electric shock, match wide blade of plug to wide slot, fully insert.

TONE SETTING CHART







METAL

	<p>NORMAL GAIN</p> 	<p>LEAD GAIN</p> 		<p>EQUALIZATION</p> 		<p>REVERB</p> 	<p>MADE IN U.S.A. BLAZER 158™ POWER</p> 
INPUT	PRE	SUPERSAT ⁺ POST	OUT	LOW MID HIGH	PHONES	LEVEL	

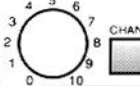
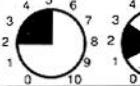
Adjust
to
Taste

Adjust
to
Taste

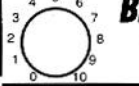







MEDIUM DISTORTION

	<p>NORMAL GAIN</p> 	<p>LEAD GAIN</p> 		<p>EQUALIZATION</p> 		<p>REVERB</p> 	<p>MADE IN U.S.A. BLAZER 158™ POWER</p> 
INPUT	PRE	SUPERSAT ⁺ POST	OUT	LOW MID HIGH	PHONES	LEVEL	

Adjust
to
Taste

Adjust
to
Taste

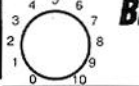
COUNTRY LEAD

	<p>NORMAL GAIN</p> 	<p>LEAD GAIN</p> 		<p>EQUALIZATION</p> 		<p>REVERB</p> 	<p>MADE IN U.S.A. BLAZER 158™ POWER</p> 
INPUT	PRE	SUPERSAT ⁺ POST	OUT	LOW MID HIGH	PHONES	LEVEL	

Adjust
to
Taste

Adjust
to
Taste

SPECIFICATIONS

POWER AMP SECTION

Rated Power & Load:

15 W RMS into 4 ohms

Power @ Clipping: (Typically)

(5% THD, 1 kHz,
120 V AC line)
15 W RMS into 4 ohms

Total Harmonic Distortion:

Less than 0.5%, 100 mW to
10 W RMS, 60 Hz to 10 kHz,
4 ohms (typically below 0.2%)

Power Consumption:

40 W, 50/60 Hz, 120 V AC

PREAMP SECTION

The following specs are measured @ 2 kHz
with the controls preset as follows:

Channel Select Normal (Out)
Low & High @ 10

Mid @ 0
SuperSat® & Post Gain @ 10
Reverb @ 0

Nominal Levels are with
Normal Gain @ 5

Minimum Levels are with
Normal Gain @ 10

Preamp Input: (Normal channel)

Impedance: High Z, 220 K ohms
Nominal Input Level: -7 dBV,
450 mV RMS
Minimum Input Level: -23 dBV,
70 mV RMS
Maximum Input Level: 0 dBV,
1 V RMS

Preamp Input: (Lead channel)

Impedance: High Z, 220 K ohms
Nominal Input Level: -64 dBV,
.6 mV RMS
Minimum Input Level: -76 dBV,
.15 mV RMS

Preamp Output:

Load Impedance: 10 K ohms
or greater
Nominal Output Level: -6 dBV,
0.5 V RMS

Headphone Output:

Load impedance: 4 ohms
or greater
Nominal power output: 20 mW
into 4 ohms
(Stereo jack, monaural signal,
disconnects internal speaker
when phone plug is inserted)

System Hum & Noise @ Nominal Input Level:

(20 Hz to 20 kHz unweighted)
80 dB below rated power

Equalization:

Special low, mid, & high passive
type EQ

BLOCK DIAGRAM

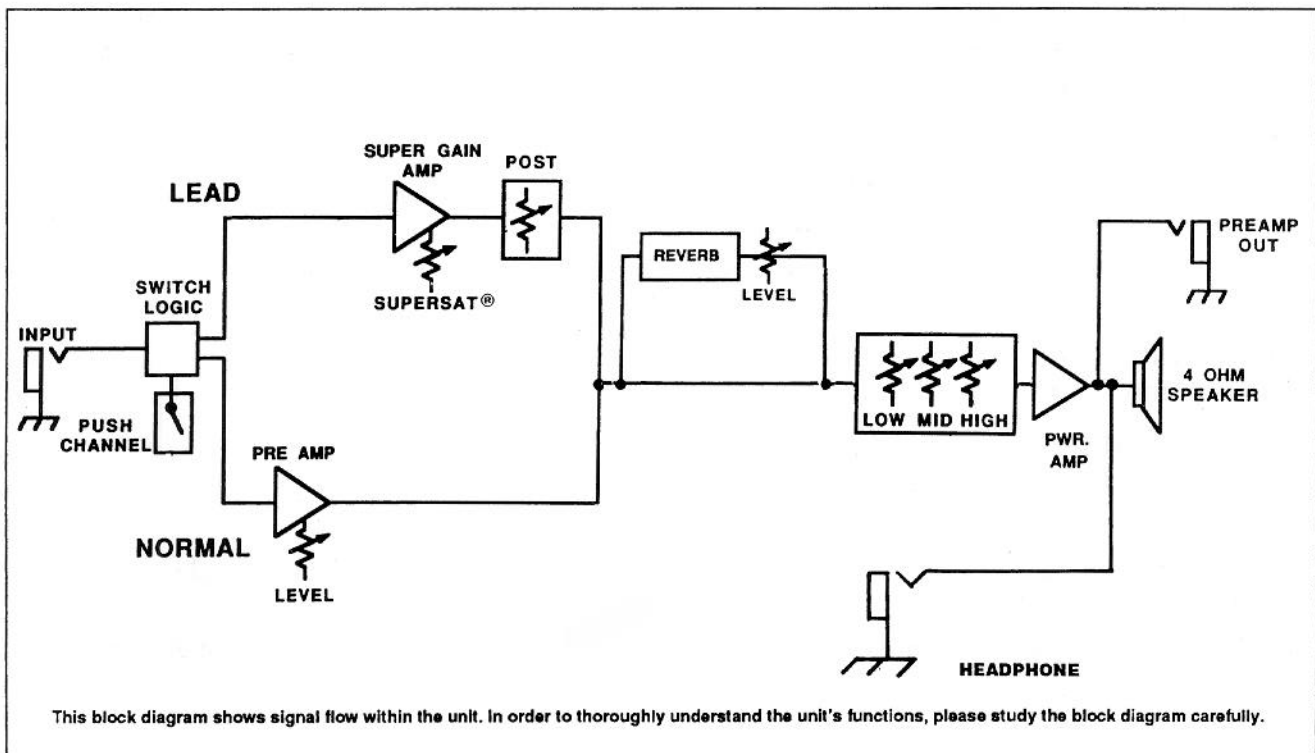

ESPAÑOL

Consulte los diagramas del panel delantero en la sección de inglés de este manual.

INPUT (Entrada) (1)

El enchufe hembra de entrada acepta todo tipo de señales provenientes de captadoras de instrumentos eléctricos de cuerda. Asegúrese de usar cables blindados de buena calidad, para conectar su instrumento al amplificador.

PRE (2)

Controla el nivel de volumen del canal normal, y no lo afectan los controles SuperSat[®] o Ganancia posterior.

CHANNEL SELECT SWITCH (Interruptor para selección del canal) (3)

Permite la selección del canal "lead" (solista) o normal. La posición hacia dentro selecciona el canal "lead" y la posición hacia fuera selecciona el canal normal.

SUPERSAT[®] (4)

(Fabricado bajo el Patente de los E.E.U.U. Número 4.811.401)

Una simulación con transistores de la distorsión de tubos (ligero recorte de señales). Para activar el efecto SuperSat[®], debe activar el canal "lead" (solista).

POST GAIN (Control de ganancia posterior del preamplificador) (5)

Controla el volumen general del canal solista. El ajuste final de nivel debe hacerse después de que se haya obtenido el sonido deseado.

PREAMP OUT (Salida de preamplificador) (6)

La salida del preamplificador puede usarse para mandar la señal a una consola de mezcla, grabadora, etc. Conecte la salida del preamplificador, utilizando un cable blindado, a una entrada de la grabadora, mezclador, etc. Esta interconexión no afecta la operación del amplificador.

LOW, MID, & HIGH EQ (Ecuador de frecuencias graves, medias, y agudas) (7)

Controles de tono pasivo que regulan las frecuencias graves, medias, y altas, respectivamente.

HEADPHONE JACK (Enchufe hembra para audífonos) (8)

Este enchufe hembra estereofónico permite a la señal fluir a ambos lados de cualquier audífono estereofónico. Se puede usar un audífono monofónico, pero no es recomendable.

REVERB LEVEL (Nivel de reverberación) (9)

Controla el nivel global de la reverberación.







POWER LED (LED indicador de corriente) (10)

Se ilumina cuando el amplificador recibe corriente alterna.

POWER SWITCH (Interruptor de corriente) (11)

Oprima el interruptor a la posición "hacia dentro" (encendido). La luz roja del piloto (indicador) se encenderá indicando que la unidad está recibiendo corriente alterna.

ADVERTENCIA: Esta unidad queda conectada a la fuente de corriente principal, aunque el interruptor de potencia esté apagado.

15 WATTS 7.7V RMS 4 OHMS	<table border="1"><tr><td></td><td>CAUTION RISK OF ELECTRIC SHOCK DO NOT OPEN</td><td></td></tr><tr><td colspan="3">WARNING TO REDUCE THE RISK OF FIRE OR ELECTRIC SHOCK DO NOT EXPOSE THIS EQUIPMENT TO RAIN OR MOISTURE. AVIS: RISQUE DE CHOC ELECTRIQUE NE PAS OUVRIR.</td></tr></table>		CAUTION RISK OF ELECTRIC SHOCK DO NOT OPEN		WARNING TO REDUCE THE RISK OF FIRE OR ELECTRIC SHOCK DO NOT EXPOSE THIS EQUIPMENT TO RAIN OR MOISTURE. AVIS: RISQUE DE CHOC ELECTRIQUE NE PAS OUVRIR.			 A PRODUCT OF PEAVEY ELECTRONICS CORP. MERIDIAN, MS. MADE IN U.S.A. BUILT UNDER U.S. PATENT NO. 4,811,401; R.O.C. UTILITY MODEL PATENT NO 51009; KOREA PATENT NO. 40007; AND PATENT PENDING
	CAUTION RISK OF ELECTRIC SHOCK DO NOT OPEN							
WARNING TO REDUCE THE RISK OF FIRE OR ELECTRIC SHOCK DO NOT EXPOSE THIS EQUIPMENT TO RAIN OR MOISTURE. AVIS: RISQUE DE CHOC ELECTRIQUE NE PAS OUVRIR.								

PRECAUCION: Para evitar corrientazos eléctricos, es necesario hacer coincidir el lado ancho del enchufe macho con la ranura ancha de la toma e insertar completamente al fondo.

FRANÇAIS

**Veillez vous référer au “front panel line art”
situé dans la section en langue anglaise de ce manuel.**

INPUT (Entrée) (1)

Cette prise d'entrée accepte les signaux de tous les types de micros (“pickups”) de guitare. Utilisez toujours un câble blindé de haute qualité pour relier la guitare à l'amplificateur.

PRE (2)

Contrôle le niveau de volume du canal “Normal” et n'est pas affecté par les commandes “SuperSat” ou “Post Gain”.

CHANNEL SELECT SWITCH (Sélecteur de canal) (3)

Permet de sélectionner les canaux “Lead” ou le canal “Normal”. La position “In” du sélecteur correspond au canal “Lead” et la position “Out” sélectionne le canal “Normal”.

SUPERSAT® (Sélecteur SuperSat®) (4)

Simulation par transistor de distorsion à tube (saturation douce). Afin de pouvoir utiliser l'effet “SuperSat”, le canal “Lead” doit être activé via la télécommande au pied.

POST GAIN (5)

Commande le volume général du canal “Lead”. Le réglage final de niveau doit être effectué après avoir obtenu la sonorité désirée à l'aide des autres réglages.

PREAMP OUT (Sortie préampli) (6)

La sortie préampli peut être utilisée pour amener le signal à une table de mixage, un magnétophone, etc. Utilisez des câbles blindés pour brancher la sortie du préampli à l'entrée d'un magnétophone, d'un mélangeur, etc. Ce branchement n'affecte pas le fonctionnement de l'amplificateur.

LOW, MID, & HIGH EQ (Égalisation graves, moyennes et aiguës) (7)

Réglages de tonalité passifs réglant respectivement les fréquences graves, moyennes et aiguës.

HEADPHONE JACK (Prise pour casque d'écoute) (8)

Ce jack stéréo envoie le signal aux deux cotés de tout casque d'écoute stéréo. L'usage d'un casque monophonique est possible mais non recommandé.

REVERB LEVEL (Niveau de réverbération) (9)

Contrôle le niveau de réverbération global.



POWER LED (DEL témoin de mise sous tension) (10)

S'allume lorsque l'ampli reçoit l'alimentation CA.

POWER SWITCH (Interrupteur d'alimentation) (11)

Mettre l'interrupteur en position “On”. La lampe témoin rouge (DEL) s'illumine indiquant que l'appareil est alimenté en courant.

AVERTISSEMENT: Cet appareil est relié à l'alimentation principale même si l'interrupteur d'alimentation est en position “Off”.

15 WATTS 7.7V RMS 4 OHMS	 CAUTION RISK OF ELECTRIC SHOCK DO NOT OPEN		
220V ~ 50/60 Hz 40 WATTS	WARNING TO REDUCE THE RISK OF FIRE OR ELECTRIC SHOCK DO NOT EXPOSE THIS EQUIPMENT TO RAIN OR MOISTURE. AVIS: RISQUE DE CHOC ELECTRIQUE NE PAS COUVRIR.		A PRODUCT OF PEAVEY ELECTRONICS CORP. MERIDIAN, MS MADE IN U.S.A. BUILT UNDER U.S. PATENT NO. 4,811,401; R.O.C. UTILITY MODEL PATENT NO 51009; KOREA PATENT NO. 40007; AND PATENT PENDING

ATTENTION: POUR ÉVITER LES CHOC ÉLECTRIQUES, INTRODUIRE LA LAME LA PLUS LARGE DE LA FICHE DANS LA BORNE CORRESPONDANTE DE LA PRISE ET POUSSER JUSQU'AU FOND.

DEUTSCH

Siehe diagramm der frontplatte im englischen teil des handbuchs.

INPUT (1)

Diese Eingangsbuchse verarbeitet Signale von Gitarrentonabnehmern aller Art. Verwenden Sie bitte nur ein qualitativ hochwertiges abgeschirmtes Kabel zum Anschluß der Gitarre an den Verstärker.

PRE (2)

Kontrolliert die Lautstärke des Normal-Kanals und wirkt sich nicht aus auf SuperSat oder Post Gain Regler.

CHANNEL SELECT SWITCH (3)

Erlaubt die Auswahl des Lead- oder des Normal-Kanals. Die "In"-Position des Schalters wählt den Lead-Kanal, die "Out"-Position den Normal-Kanal an.

SUPERSAT (4)

Eine transistorsimulierte Röhrenverzerrung (sanftes Übersteuern). Um den SuperSat-Effekt zu aktivieren, muß der Lead-Kanal eingeschaltet sein.

POST GAIN (5)

Kontrolliert den gesamten Lautstärke-pegel des Hauptkanals (Mastervolumen). Die endgültige Lautstärkeregelung sollte vorgenommen werden, nachdem der gewünschte Sound eingestellt ist.

PREAMP OUT (Vorstufenausgang) (6)

Dieser Ausgang kann zum Anschluß des Verstärkers an einen Mixer, eine Bandmaschine, etc. verwendet werden. Verbinden Sie den Ausgang mit Hilfe eines abgeschirmten Kabels mit dem Eingang des entsprechenden Gerätes. Dieser Anschluß beeinflusst die Funktionen des Verstärkers nicht.

LOW, MID & HIGH EQ (7)

Hierbei handelt es sich um passive Klangregler, die tiefe, mittlere und hohe Frequenzen entsprechend regeln.

HEADPHONE JACK (Kopfhörer-Anschluss) (8)

Dieser Stereo-Jack-Anschluss überträgt das Signal auf beide Kopfhörer-Muscheln. Ein Mono-Kopfhörer kann zwar verwendet werden, wird jedoch nicht empfohlen.

REVERB LEVEL (9)

Regelt den Reverb-Pegel.



POWER LED (10)

Zeigt die eingeschaltete Netzspannung an.

POWER SWITCH (Netzschalter) (11)

Bringen Sie den Schalter auf die ON-Position. Die rote Kontrolllampe (LED) leuchtet und zeigt an, daß das Gerät eingeschaltet ist.

WARNUNG: Diese Einheit ist immer mit dem Stromnetz verbunden auch wenn der Netzschalter ausgeschaltet ist.

15 WATTS 7.7V RMS 4 OHMS	 <p>CAUTION RISK OF ELECTRIC SHOCK DO NOT OPEN</p> <p>WARNING TO REDUCE THE RISK OF FIRE OR ELECTRIC SHOCK DO NOT EXPOSE THIS EQUIPMENT TO RAIN OR MOISTURE. AVIS: RISQUE DE CHOC ELECTRIQUE NE PAS OUVRIR.</p>	 <p>A PRODUCT OF PEAVEY ELECTRONICS CORP. MERIDIAN, MS. MADE IN U.S.A. BUILT UNDER U.S. PATENT NO. 4,811,401; R.O.C. UTILITY MODEL PATENT NO. 51639; KOREA PATENT NO. 40007; AND PATENT PENDING</p>
--------------------------------	--	--

VORSICHT: Um einen elektrischen Schlag zu vermeiden, den Stecker immer komplett in die Steckdose einführen.

THIS LIMITED WARRANTY VALID ONLY WHEN PURCHASED AND REGISTERED IN THE UNITED STATES OR CANADA. ALL EXPORTED PRODUCTS ARE SUBJECT TO WARRANTY AND SERVICES TO BE SPECIFIED AND PROVIDED BY THE AUTHORIZED DISTRIBUTOR FOR EACH COUNTRY.

Ces clauses de garantie ne sont valables qu'aux Etats-Unis et au Canada. Dans tous les autres pays, les clauses de garantie et de maintenance sont fixées par le distributeur national et assurées par lui selon la législation en vigueur.

Diese Garantie ist nur in den USA und Kanada gültig. Alle Export-Produkte sind der Garantie und dem Service des Importeurs des jeweiligen Landes unterworfen. Esta garantía es válida solamente cuando el producto es comprado en E.U. continentales o en Canada. Todos los productos que sean comprados en el extranjero, están sujetos a las garantías y servicios que cada distribuidor autorizado determine y ofrezca en los diferentes países.

PEAVEY ONE-YEAR LIMITED WARRANTY/REMEDY

PEAVEY ELECTRONICS CORPORATION ("PEAVEY") warrants this product, EXCEPT for covers, footswitches, patchcords, tubes and meters, to be free from defects in material and workmanship for a period of one (1) year from date of purchase, PROVIDED, however, that this limited warranty is extended only to the original retail purchaser and is subject to the conditions, exclusions, and limitations hereinafter set forth:

PEAVEY 90-DAY LIMITED WARRANTY ON TUBES AND METERS

If this product contains tubes or meters, Peavey warrants the tubes or meters contained in the product to be free from defects in material and workmanship for a period of ninety (90) days from date of purchase; PROVIDED, however, that this limited warranty is extended only to the original retail purchaser and is also subject to the conditions, exclusions, and limitations hereinafter set forth.

CONDITIONS, EXCLUSIONS, AND LIMITATIONS OF LIMITED WARRANTIES

These limited warranties shall be void and of no effect, if:

- a. The first purchase of the product is for the purpose of resale; or
- b. The original retail purchase is not made from an AUTHORIZED PEAVEY DEALER; or
- c. The product has been damaged by accident or unreasonable use, neglect, improper service or maintenance, or other causes not arising out of defects in material or workmanship; or
- d. The serial number affixed to the product is altered, defaced, or removed.

In the event of a defect in material and/or workmanship covered by this limited warranty, Peavey will:

- a. In the case of tubes or meters, replace the defective component without charge.
- b. In other covered cases (i.e., cases involving anything other than covers, footswitches, patchcords, tubes or meters), repair the defect in material or workmanship or replace the product, at Peavey's option; and provided, however, that, in any case, all costs of shipping, if necessary, are paid by you, the purchaser.

THE WARRANTY REGISTRATION CARD SHOULD BE ACCURATELY COMPLETED AND MAILED TO AND RECEIVED BY PEAVEY WITHIN FOURTEEN (14) DAYS FROM THE DATE OF YOUR PURCHASE.

In order to obtain service under these warranties, you must:

- a. Bring the defective item to any PEAVEY AUTHORIZED DEALER or AUTHORIZED PEAVEY SERVICE CENTER and present therewith the ORIGINAL PROOF OF PURCHASE supplied to you by the AUTHORIZED PEAVEY DEALER in connection with your purchase from him of this product.

If the DEALER or SERVICE CENTER is unable to provide the necessary warranty service you will be directed to the nearest other PEAVEY AUTHORIZED DEALER or AUTHORIZED PEAVEY SERVICE CENTER which can provide such service.

OR

- b. Ship the defective item, prepaid, to:

PEAVEY ELECTRONICS CORPORATION
International Service Center
326 Hwy. 11 & 80 East
MERIDIAN, MS 39301

including therewith a complete, detailed description of the problem, together with a legible copy of the original PROOF OF PURCHASE and a complete return address. Upon Peavey's receipt of these items:

If the defect is remedial under these limited warranties and the other terms and conditions expressed herein have been complied with, Peavey will provide the necessary warranty service to repair or replace the product and will return it, FREIGHT COLLECT, to you, the purchaser.

Peavey's liability to the purchaser for damages from any cause whatsoever and regardless of the form of action, including negligence, is limited to the actual damages up to the greater of \$500.00 or an amount equal to the purchase price of the product that caused the damage or that is the subject of or is directly related to the cause of action. Such purchase price will be that in effect for the specific product when the cause of action arose. This limitation of liability will not apply to claims for personal injury or damage to real property or tangible personal property allegedly caused by Peavey's negligence. Peavey does not assume liability for personal injury or property damage arising out of or caused by a non-Peavey alteration or attachment, nor does Peavey assume any responsibility for damage to interconnected non-Peavey equipment that may result from the normal functioning and maintenance of the Peavey equipment.

UNDER NO CIRCUMSTANCES WILL PEAVEY BE LIABLE FOR ANY LOST PROFITS, LOST SAVINGS, ANY INCIDENTAL DAMAGES, OR ANY CONSEQUENTIAL DAMAGES ARISING OUT OF THE USE OR INABILITY TO USE THE PRODUCT, EVEN IF PEAVEY HAS BEEN ADVISED OF THE POSSIBILITY OF SUCH DAMAGES.

THESE LIMITED WARRANTIES ARE IN LIEU OF ANY AND ALL WARRANTIES, EXPRESSED OR IMPLIED, INCLUDING, BUT NOT LIMITED TO, THE IMPLIED WARRANTIES OF MERCHANTABILITY AND FITNESS FOR A PARTICULAR USE; PROVIDED, HOWEVER, THAT IF THE OTHER TERMS AND CONDITIONS NECESSARY TO THE EXISTENCE OF THE EXPRESSED, LIMITED WARRANTIES, AS HEREINABOVE STATED, HAVE BEEN COMPLIED WITH, IMPLIED WARRANTIES ARE NOT DISCLAIMED DURING THE APPLICABLE ONE-YEAR OR NINETY-DAY PERIOD FROM DATE OF PURCHASE OF THIS PRODUCT.

SOME STATES DO NOT ALLOW LIMITATION ON HOW LONG AN IMPLIED WARRANTY LASTS, OR THE EXCLUSION OR LIMITATION OF INCIDENTAL OR CONSEQUENTIAL DAMAGES, SO THE ABOVE LIMITATIONS OR EXCLUSIONS MAY NOT APPLY TO YOU. THESE LIMITED WARRANTIES GIVE YOU SPECIFIC LEGAL RIGHTS, AND YOU MAY ALSO HAVE OTHER RIGHTS WHICH MAY VARY FROM STATE TO STATE.

THESE LIMITED WARRANTIES ARE THE ONLY EXPRESSED WARRANTIES ON THIS PRODUCT, AND NO OTHER STATEMENT, REPRESENTATION, WARRANTY, OR AGREEMENT BY ANY PERSON SHALL BE VALID OR BINDING UPON PEAVEY.

In the event of any modification or disclaimer of expressed or implied warranties, or any limitation of remedies, contained herein conflicts with applicable law, then such modification, disclaimer or limitation, as the case may be, shall be deemed to be modified to the extent necessary to comply with such law.

Your remedies for breach of these warranties are limited to those remedies provided herein and Peavey Electronics Corporation gives this limited warranty only with respect to equipment purchased in the United States of America.

INSTRUCTIONS — WARRANTY REGISTRATION CARD

1. Mail the completed WARRANTY REGISTRATION CARD to:

PEAVEY ELECTRONICS CORPORATION
POST OFFICE BOX 2898
MERIDIAN, MISSISSIPPI 39302-2898

- a. Keep the PROOF OF PURCHASE. In the event warranty service is required during the warranty period, you will need this document. There will be no identification card issued by Peavey Electronics Corporation.
2. IMPORTANCE OF WARRANTY REGISTRATION CARDS AND NOTIFICATION OF CHANGES OF ADDRESSES:
 - a. Completion and mailing of WARRANTY REGISTRATION CARDS — Should notification become necessary for any condition that may require correction, the REGISTRATION CARD will help ensure that you are contacted and properly notified.
 - b. Notice of address changes — If you move from the address shown on the WARRANTY REGISTRATION CARD, you should notify Peavey of the change of address so as to facilitate your receipt of any bulletins or other forms of notification which may become necessary in connection with any condition that may require dissemination of information or correction.
3. You may contact Peavey directly by telephoning (601) 483-5365.

IMPORTANT SAFETY INSTRUCTIONS

WARNING: When using electric products, basic cautions should always be followed, including the following.

1. Read all safety and operating instructions before using this product.
2. All safety and operating instructions should be retained for future reference.
3. Obey all cautions in the operating instructions and on the back of the unit.
4. All operating instructions should be followed.
5. This product should not be used near water, i.e., a bathtub, sink, swimming pool, wet basement, etc.
6. This product should be located so that its position does not interfere with its proper ventilation. It should not be placed flat against a wall or placed in a built-in enclosure that will impede the flow of cooling air.
7. This product should not be placed near a source of heat such as a stove, radiator, or another heat producing amplifier.
8. Connect only to a power supply of the type marked on the unit adjacent to the power supply cord.
9. Never break off the ground pin on the power supply cord. For more information on grounding, write for our free booklet "Shock Hazard and Grounding."
10. Power supply cords should always be handled carefully. Never walk or place equipment on power supply cords. Periodically check cords for cuts or signs of stress, especially at the plug and the point where the cord exits the unit.
11. The power supply cord should be unplugged when the unit is to be unused for long periods of time.
12. If this product is to be mounted in an equipment rack, rear support should be provided.
13. Metal parts can be cleaned with a damp rag. The vinyl covering used on some units can be cleaned with a damp rag or an ammonia-based household cleaner if necessary. Disconnect unit from power supply before cleaning.
14. Care should be taken so that objects do not fall and liquids are not spilled into the unit through the ventilation holes or any other openings.
15. This unit should be checked by a qualified service technician if:
 - a. The power supply cord or plug has been damaged.
 - b. Anything has fallen or been spilled into the unit.
 - c. The unit does not operate correctly.
 - d. The unit has been dropped or the enclosure damaged.
16. The user should not attempt to service this equipment. All service work should be done by a qualified service technician.
17. This product should be used only with a cart or stand that is recommended by Peavey Electronics.
18. Exposure to extremely high noise levels may cause a permanent hearing loss. Individuals vary considerably in susceptibility to noise induced hearing loss, but nearly everyone will lose some hearing if exposed to sufficiently intense noise for a sufficient time. The U.S. Government's Occupational Safety and Health Administration (OSHA) has specified the following permissible noise level exposures.

Duration Per Day In Hours	Sound Level dBA, Slow Response
8	90
6	92
4	95
3	97
2	100
1 1/2	102
1	105
1/2	110
1/4 or less	115

According to OSHA, any exposure in excess of the above permissible limits could result in some hearing loss.

Ear plugs or protectors in the ear canals or over the ears must be worn when operating this amplification system in order to prevent a permanent hearing loss if exposure is in excess of the limits as set forth above. To ensure against potentially dangerous exposure to high sound pressure levels, it is recommended that all persons exposed to equipment capable of producing high sound pressure levels such as this amplification system be protected by hearing protectors while this unit is in operation.

SAVE THESE INSTRUCTIONS!



Features and specifications subject to change without notice.

Peavey Electronics Corporation 711 A Street / Meridian, MS 39301 / U.S.A. / (601) 483-5365 / Telex 504115 / Fax 486-1278
©1994 #80301898 Printed in U.S.A. 11/94

Free Manuals Download Website

<http://myh66.com>

<http://usermanuals.us>

<http://www.somanuals.com>

<http://www.4manuals.cc>

<http://www.manual-lib.com>

<http://www.404manual.com>

<http://www.luxmanual.com>

<http://aubethermostatmanual.com>

Golf course search by state

<http://golfingnear.com>

Email search by domain

<http://emailbydomain.com>

Auto manuals search

<http://auto.somanuals.com>

TV manuals search

<http://tv.somanuals.com>