

# EXPRESS™ 112 S

## TRANSTUBE™ SERIES

O  
P  
E  
R  
A  
T  
I  
O  
N  
G  
C  
O  
U  
L  
D  
E



O  
**TRANSTUBE**   
TECHNOLOGY  
PATENTS APPLIED FOR

TM



**A** Intended to alert the user to the presence of uninsulated “dangerous voltage” within the product’s enclosure that may be of sufficient magnitude to constitute a risk of electric shock to persons.

**A** Intended to alert the user of the presence of important operating and maintenance (servicing) instructions in the literature accompanying the product.

**CAUTION:** Risk of electrical shock - DO NOT OPEN!

**CAUTION:** To reduce the risk of electric shock, do not remove cover. No user serviceable parts inside. Refer servicing to qualified service personnel.

**WARNING:** To prevent electrical shock or fire hazard, do not expose this appliance to rain or moisture. Before using this appliance, read the operating guide for further warnings.



Este símbolo tiene el propósito de alertar al usuario de la presencia de "(voltaje) peligroso" que no tiene aislamiento dentro de la caja de l producto que puede tener una magnitud suficiente como para constituir riesgo de corrientazo.



Este símbolo tiene el propósito de alertar al usuario de la presencia de instrucciones importantes sobre la operación y mantenimiento en la literatura que viene con el producto.

**PRECAUCION:** Riesgo de corrientazo - No abra.

**PRECAUCION:** Para disminuir el riesgo de corrientazo, no abra la cubierta. No hay piezas adentro que el usuario pueda reparar. Deje todo mantenimiento a los técnicos calificados.

**ADVERTENCIA:** Para evitar corrientazos o peligro de incendio, no deje expuesto a la lluvia o humedad este aparato. Antes de usar este aparato, lea más advertencias en la guía de operación.



Ce symbole est utilisé pur indiquer à l'utilisateur la présence à l'intérieur de ce produit de tension non-isolée dangereuse pouvant être d'intensité suffisante pour constituer un risque de choc électrique.



Ce symbole est utilisé pour indiquer à l'utilisateur qu'il ou qu'elle trouvera d'importantes instructions sur l'utilisation et l'entretien (service) de l'appareil dans la littérature accompagnant le produit.

**ATTENTION:** Risques de choc électrique - NE PAS OUVRIR!

**ATTENTION:** Afin de réduire le risque de choc électrique, ne pas enlever le couvercle. Il ne se trouve à l'intérieur aucune pièce pouvant être réparée par l'utilisateur. Confier l'entretien à un personnel qualifié.

**AVERTISSEMENT:** Afin de prévenir les risques de décharge électrique ou de feu, n'exposez pas cet appareil à la pluie ou à l'humidité. A v a n t d'utiliser cet appareil, lisez les avertissements supplémentaires situés dans le g u i d e .



Dieses Symbol soll den Anwender vor unisolierten gefährlichen Spannungen innerhalb des Gehäuses warnen, die von Ausreichender Stärke sind, um einen elektrischen Schlag verursachen zu können.



Dieses Symbol soll den Benutzer auf wichtige Instruktionen in der Bedienungsanleitung aufmerksam machen, die Handhabung und Wartung des Produkts betreffen.

**VORSICHT:** Risiko - Elektrischer Schlag! Nicht öffnen!

**VORSICHT:** Um das Risiko eines elektrischen Schlages zu vermeiden, nicht die Abdeckung entfernen. Es befinden sich keine Teile darin, die vom Anwender repariert werden könnten. Reparaturen nur von qualifiziertem Fachpersonal durchführen lassen.

**ACHTUNG:** Um einen elektrischen Schlag oder Feuergefahr zu vermeiden, sollte dieses Gerät nicht dem Regen oder Feuchtigkeit ausgesetzt werden. Vor Inbetriebnahme unbedingt die Bedienungsanleitung lesen.

Congratulations on your purchase of the all new Express™112 TransTube™ Series. This amp represents years of research on vacuum tube emulation, resulting in a totally new Express. The preamp has been redesigned, using patent-applied for technology that redefines tubelike distortion and harmonic generation in solid-state amps.

The new T. Dynamics circuitry, also awaiting several patents, creates the long sought for tube power compression phenomenon. This, when combined with the preamp circuitry, yields the closest tube amp simulation to date. The compression effect is increased by turning the T. Dynamics control down, which lowers the power level the amp puts out.

To further enhance the performance of the Express, an added external speaker jack is included. The speaker has been upgraded to a Sheffield, and an effects loop is included to allow for greater flexibility.

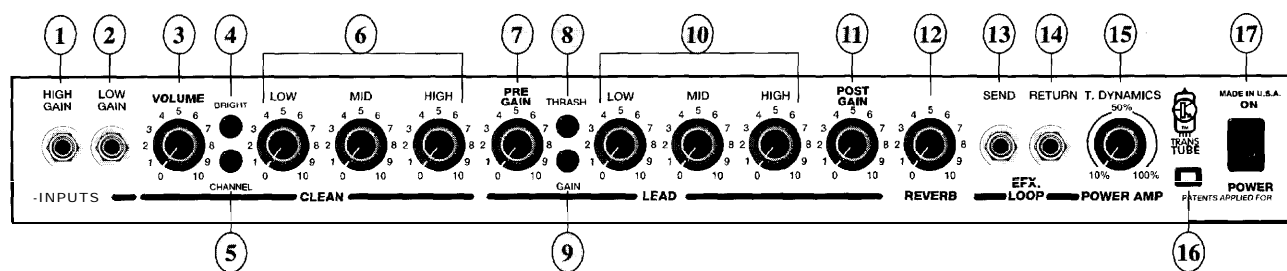

## HIGH GAIN INPUT (1)

Used for most electric guitars. It is 6 dB louder than Low Gain input.

## LOW GAIN INPUT (2)

Provided for instruments that have extremely high outputs, which can result in overdriving (distorting) the High Gain input. If both inputs are used simultaneously, the output levels are the same (both are Low Gain).

## VOLUME (3)

Controls the volume level of the Clean channel.

## BRIGHT SWITCH (4)

Provides a preset boost (6 dB) to treble frequencies. To activate, depress the switch to its “in” position.

## CHANNEL SELECT SWITCH (5)

Allows selection of the Lead or Clean channel. The “in” position of the switch selects the Lead channel and the “out” position selects Clean.

**NOTE:** Channel selection may also be achieved by the remote footswitch. If remote selection is desired, the channel switch must be in the “in” (Lead) position.

## LOW, MID, & HIGH EQ (6)

Passive tone controls that regulate the low, mid, and high frequencies, respectively.

## PRE GAIN (7)

Controls the input volume level of the Lead channel.

## THRASH SWITCH (8)

Notches the mid range about 20 dB.

## **GAIN SWITCH (9)**

Boosts the overall system gain. Depress to the “in” position to activate.

## **LOW, MID, & HIGH EQ (10)**

Passive tone controls that regulate the low, mid, and high frequencies, respectively.

## **POST GAIN (11)**

Controls the overall volume level of the Lead channel. The final level adjustment should be made after the desired sound has been achieved.

## **REVERB LEVEL (12)**

Controls the overall reverb level.

## **EFFECTS SEND (13)**

Output for supplying signals to external low-level effects or signal processing equipment.

## **EFFECTS RETURN (14)**

Input for returning signals from external low-level effects or signal processing equipment.

## **T. DYNAMICS CONTROL (15)**

Adjusts the power level of the amplifier from 10% to 100% power. When set to lower settings, the power compression simulation will be much more pronounced.

## **POWER LED (16)**

Illuminates when AC power is being supplied to the amp.

## **POWER SWITCH (17)**

Depress the switch to the “on” position. The red pilot light (LED) will illuminate indicating power is being supplied to the unit.

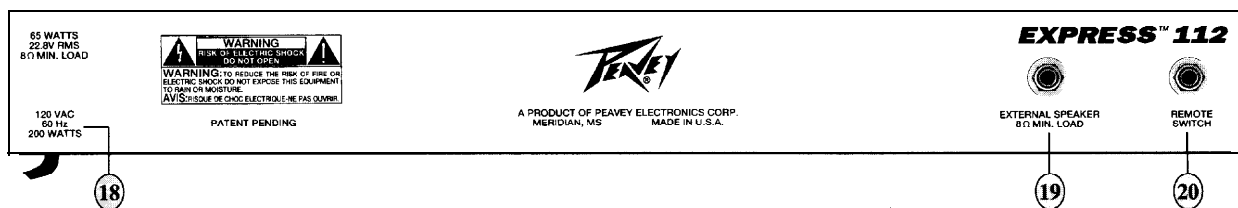

## **! LINE CORD (120 V PRODUCTS ONLY) (18)**

For your safety, we have incorporated a three-wire line (mains) cable with proper grounding facilities. It is not advisable to remove the ground pin under any circumstances. If it is necessary to use the equipment without proper grounding facilities, suitable grounding adaptors should be used. Less noise and greatly reduced shock hazard exists when the unit is operated with the proper grounded receptacles.

## **A EXTERNAL SPEAKER JACK (19)**

Provided for connection of external speaker cabinet. Minimum total impedance is 8 ohms. Disconnects internal speaker when used.

## **REMOTE SWITCH JACK (20)**

Provided for the connection of the optional remote footswitch. The footswitch is used to select the Lead or Normal channels and defeat reverb. When using remote footswitch, always insert the plug fully (second click) to insure proper operation.

# SPECIFICATIONS

## Rated Power & Load:

Power specs measured with  
T. Dynamics @10  
65 W RMS into 8 ohms  
4 ohms not recommended

## Power @ Clipping: (Typically)

(5% THD, 1 kHz, 120 V AC line)  
65 W RMS into 8 ohms

## Frequency Response:

+0, 3 dB, 60 Hz to 20 kHz,  
@ 50 W RMS into 8 ohms

## Hum & Noise:

Greater than 78dB below rated  
power

## Power Consumption:

200 W @ 50/60 Hz, 120 V AC  
(Domestic)

## PREAMP SECTION

The following specs are measured  
@ 1 kHz with the controls preset  
as follows:

Push Bright, Off (Out)  
Channel Select Normal (Out)

Low & High @10  
Mid @ 0  
Pre & Post Gain @10  
Gain & Thrash, Off (Out)  
Normal Levels are with normal  
volume @ 5  
Minimum Levels are with normal  
volume @10

## Preamp High Gain Input:

Impedance: High Z, 1 M ohm  
Nominal Input Level: -14 dBV,  
200 mV RMS  
Minimum Input Level: -24 dBV,  
60 mV RMS  
Maximum Input Level: 0 dBV,  
1 V RMS

## Preamp Low Gain Input:

Impedance: High Z, 44 K ohms  
Nominal Input Level: -8 dBV,  
400 mV RMS  
Minimum Input Level: -18 dBV,  
120 mV RMS  
Maximum Input Level: 6 dBV,  
2 V RMS

## Effects Return:

Impedance: High Z, 22 K ohms  
Designed Input Level: -10 dBV,  
0.3 V RMS  
(Switching jack provides Effects  
Send to Effects Return connection  
when not used)

## System Hum & Noise

### @ Nominal Input Level:

(20 Hz to 20 kHz unweighted)  
68 dB below rated power

## Equalization:

Special low, mid, & high passive  
type EQ  
Push Bright: +6 dB @ 2 kHz  
Push Thrash: -20 dB notch @ 1 kHz  
in Lead channel  
Push Gain: Increases Lead gain

## External Footswitch Functions:

Lead Channel Defeat (when selected  
with button)  
Reverb Defeat

## Effects Send:

Load Impedance: 1 K ohm  
or greater  
Nominal Output Level: -10 dBV,  
0.3 V RMS

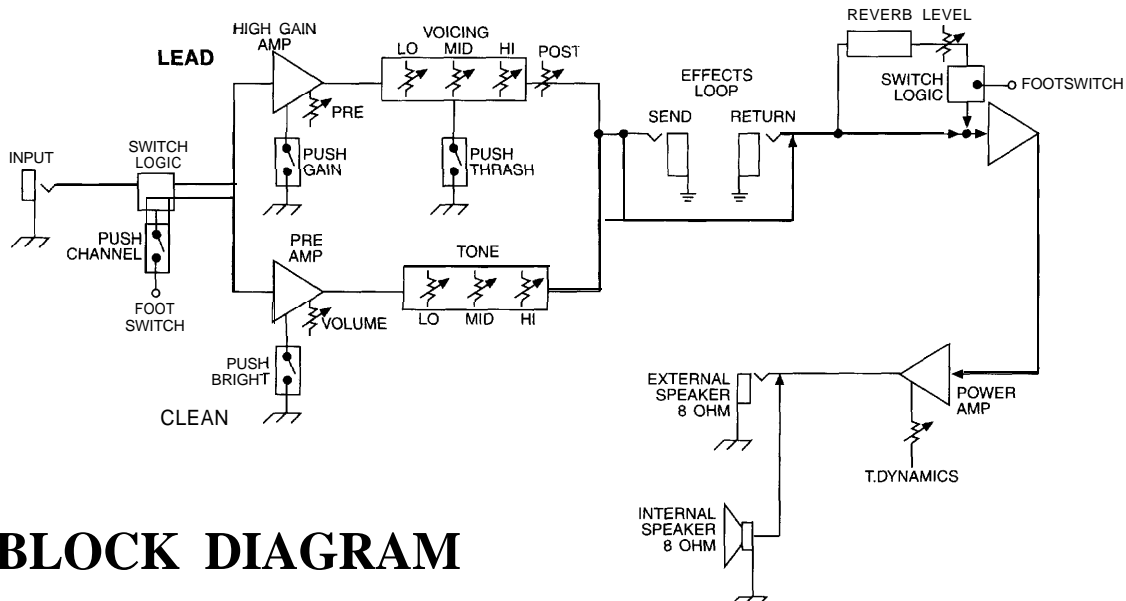

# BLOCK DIAGRAM

# tone settings

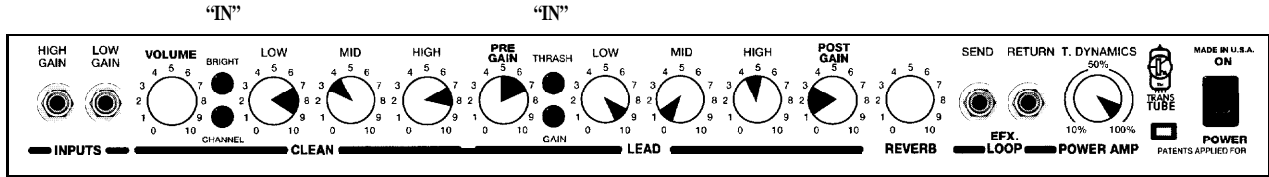

ADJUST TO TASTE

CLEAN

METAL

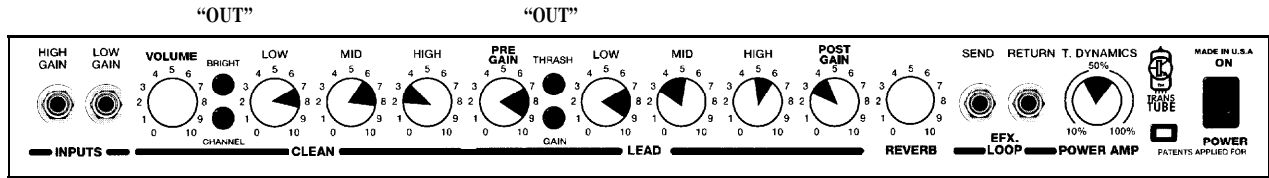

ADJUST TO TASTE

JAZZ

MEDIUM DISTORTION

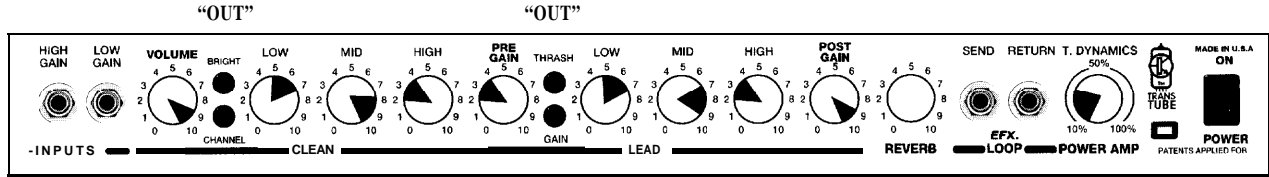

CLEAN BLUES

DIRTY BLUES



## Consulte los diagramas del panel delantero en la sección de inglés de este manual.

### **HIGH GAIN INPUT (Entrada de ganancia alta)(1)**

Se usa para la mayoría de las guitarras eléctricas. Tiene 6 dB más volumen que la entrada de baja ganancia.

### **LOW GAIN INPUT (Entrada de baja ganancia)(2)**

Se suministra para instrumentos que tienen una salida extremadamente alta, la cual puede causar la sobrecarga (distorsión) de la entrada de alta ganancia. Si se usan ambas entradas simultáneamente, el nivel de salida es el mismo (ambos son de baja ganancia).

### **VOLUME (El volumen)(3)**

Controla el nivel de volumen del canal "clean".

### **BRIGHT SWITCH (Interruptor de brillo)(4)**

Proporciona un impulso preajustado de +6 dB a las frecuencias agudas. Para activarlo, empuje el interruptor a la posición "hacia dentro".

### **CHANNEL SELECT SWITCH (Interruptor para selección del canal)(5)**

Permite la selección del canal "lead" (solista) o "clean." La posición hacia dentro selecciona el canal "lead" y la posición hacia fuera selecciona el canal "clean".

NOTA: También se puede lograr la selección del canal por medio del pedal interruptor remoto. Si desea la selección a control remoto, el interruptor de canal debe estar en la posición "in" (hacia adentro) (canal de solista).

### **LOW, MID, & HIGH EQ (Ecuador de frecuencias graves, medias, y agudas)(6)**

Controles de tono pasivo que regulan las frecuencias graves, medias, y altas, respectivamente.

### **PRE GAIN (Control del preamplificador)(7)**

Controla la entrada de volumen del canal solista.

### **THRASH (Conmutador de batido)(8)**

Recorta la escala media en casi 20 dB.

### **GAIN SWITCH (Interruptor de ganancia)(9)**

Proporciona impulso a la ganancia general del sistema. Para activarlo oprímalo a la posición "in" (hacia adentro).

### **LOW, MID, & HIGH EQ (Ecuador de frecuencias graves, medias, y agudas)(10)**

Controles de tono pasivo que regulan las frecuencias graves, medias, y altas, respectivamente.

### **POST GAIN (Control de ganancia posterior del preamplificador)(11)**

Controla el volumen general del canal solista. El ajuste final de nivel debe hacerse después de que se haya obtenido el sonido deseado.

### **REVERB LEVEL (Nivel de reverberation)(12)**

Controla el nivel global de la reverberación.

### **EFFECTS SEND (Envío de efectos)(13)**

Salida para proporcionar señales a efectos exteriores de bajo nivel o a equipos procesadores de señal.

### **EFFECTS RETURN (Retorno de efectos)(14)**

Entrada para el retorno de señales procedentes de equipos de efectos externos de bajo nivel o de procesadores de señal.

## T. DYNAMICS CONTROL (Control de1 circuit0 T. Dynamics) (15)

Ajusta el nivel de potencia de1 amplificador de 10% a 100%. Cuando está en la posición más baja, la simulación de compresión de potencia será más pronunciada.

## POWER LED (LED indicador de corriente)(16)

Se ilumina cuando el amplificador recibe corriente alterna.

## POWER SWITCH (Interruptor de corriente)(17)

Oprima el interruptor a la posición "hacia dentro" (encendido). La luz roja de1 piloto (indicador) se encenderá indicando que la unidad está recibiendo corriente alterna.

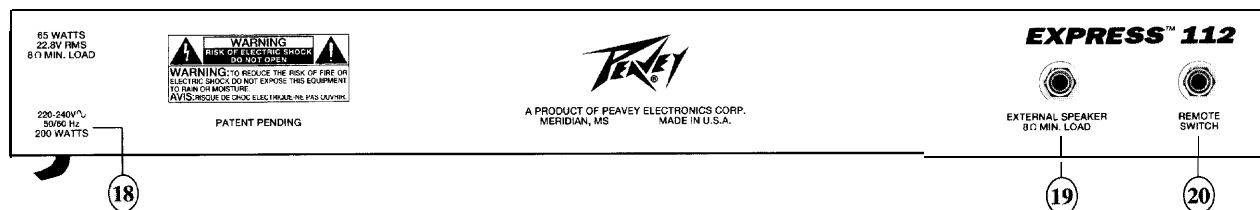

## LINE CORD (120 V PRODUCTS ONLY) (Cable de corriente para 120 v solamente) (18)

Para su protección hemos incorporado un cable de 3 polos con polo a tierra. No es recomendable remover la pata de1 polo a tierra bajo ninguna circunstancia, se recomienda un adaptador en case necesario. Esto reducirá ruidos y peligrosos corrientazos.

## EXTERNAL SPEAKER JACK (Enchufe hembra de altavoz externo)(19)

Se suministra para la conexión de bafles externos. La impedancia total minima es de 8 ohms. Desconecte la bocina interna cuando use la bocina externa.

## REMOTE SWITCH JACK (Enchufe hembra de interruptor remoto)(20)

Se suministra para la conexión de1 pedal interruptor de control remoto optional. El pedal interruptor se utiliza para seleccionar los canales solista o normal y desactivar la reverberation. Cuando utilice el pedal de control remoto, inserte siempre la clavija completamente (Segundo retén) para asegurar el correcto funcionamiento.



## **Veillez vous référer au “front panel line art” situé dans la section en langue anglaise de ce manuel.**

### **HIGH GAIN INPUT (Entree haut gain) (1)**

Cette prise s'utilise avec la plupart des guitares électriques. Elle donne un gain supérieur de 6 dB à l'entrée “Low Gain”.

### **LOW GAIN INPUT (Entree faible gain) (2)**

Cette prise accepte les instruments à très haut niveau de sortie qui causeraient de la saturation (distorsion) sur l'entrée “High Gain”. Si les deux entrées sont utilisées simultanément, les niveaux sont alors équivalents (“Low Gain”).

### **VOLUME (3)**

Contrôle le niveau de volume du canal “Clean”.

### **BRIGHT SWITCH (Sélecteur de brillance) (4)**

Accentue (6 dB) les fréquences aiguës. Pour activer, mettre le bouton en position “In”.

### **CHANNEL SELECT SWITCH (Sélecteur de canal) (5)**

Permet de sélectionner les canaux “Lead” ou “Clean”. La position “In” du sélecteur correspond au canal “Lead”. La position “Out” sélectionne le canal “Clean”.

**NOTE:** La sélection de canal peut aussi s'accomplir à distance à l'aide de la pédale-interrupteur. Pour que la sélection à distance soit possible, le canal doit être en position “In” (“Lead”).

### **LOW, MID, & HIGH EQ (Égalisation graves, moyennes et aiguës) (6)**

Réglages de tonalité passifs réglant respectivement les fréquences graves, moyennes et aiguës.

### **PRE GAIN (7)**

Contrôle le niveau de volume à l'entrée sur du canal “Lead”.

### **THRASH SWITCH (Commutateur anti-emballement) (8)**

Ajuste le registre moyen d'environ 20 dB.

### **GAIN SWITCH (Interrupteur de gain) (9)**

Hausse le gain global du système. Abaisser à la position “In” pour activer.

### **LOW, MID, & HIGH EQ (Égalisation graves, moyennes et aiguës) (10)**

Réglages de tonalité passifs réglant respectivement les fréquences graves, moyennes et aiguës.

### **POST GAIN (11)**

Commande le volume général du canal “Lead”. Le réglage final de niveau doit être effectué après avoir obtenu la sonorité désirée à l'aide des autres réglages.

### **REVERB LEVEL (Niveau de reverberation) (12)**

Contrôle le niveau de reverberation global.

### **EFFECTS SEND (Envoi d'effets) (13)**

Prise de sortie servant à fournir des signaux à des appareils externes de traitement de signal ou d'effets à bas niveau.

### **EFFECTS RETURN (Retour d'effets) (14)**

Prise d'entrée pour signaux provenant d'appareils externes de traitement de signal ou d'effets à bas niveau.

## T. DYNAMICS CONTROL (Commande «Dynamique T»)(15)

Règle le niveau de puissance de l'amplificateur de 10 à 100%. Lorsqu'il est réglé en bas de plage, la simulation de compression de puissance est bien plus prononcée.

## POWER LED (DEL témoin de mise sous tension) (16)

S'allume lorsque l'ampli reçoit l'alimentation CA.

## POWER SWITCH (Interrupteur d'alimentation)(17)

Mettez l'interrupteur en position "On". La lampe témoin rouge (DEL) s'allume indiquant que l'appareil est alimenté en courant.

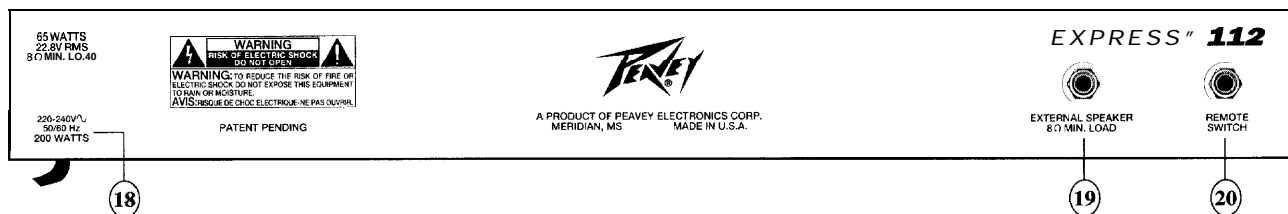

## LINE CORD (120 V products only) (Cordon d'alimentation pour appareils 120 V seulement) (18)

Pour votre sécurité, nous avons incorporé un câble d'alimentation secteur à 3 fils avec mise-à-terre appropriée. Il n'est pas recommandé d'enlever la broche de mise-à-terre en aucune circonstance. S'il est nécessaire d'utiliser l'équipement sans mise-à-terre appropriée, utilisez des adaptateurs de mise-à-terre convenables. Une bonne mise-à-terre amoindrit le bruit de fond et réduit grandement les risques de choc.

## EXTERNAL SPEAKER JACK (Prise pour haut-parleur externe)(19)

Sortie pour branchement d'une enceinte de haut-parleur séparée. L'impédance totale résultante doit être au minimum 16 ohms. Débranche le haut-parleur interne lorsque utilisé.

## REMOTE SWITCH JACK (Prise pour interrupteur à distance) (20)

Sert à brancher la pédale-interrupteur (en option). L'interrupteur au pied est utilisé pour sélectionner les canaux "Normal" ou "Lead" et pour mettre la reverberation hors service. Afin d'assurer un bon fonctionnement lors de l'utilisation de l'interrupteur au pied, insérez la fiche à fond jusqu'au second cran (au second clic).

## **Siehe Diagramm der Frontplatte im englischen Teil des Handbuchs.**

### **HIGH GAIN INPUT (1)**

Dieser Eingang kann für die meisten elektrischen Gitarren verwendet werden. Er ist 6 dB empfindlicher als der Low Gain Input.

### **LOW GAIN INPUT (2)**

Dieser Eingang ist für die Instrumente vorgesehen, die ein besonders hohes Ausgangssignal erzeugen. Falls beide Eingänge gleichzeitig benutzt werden, sind die Ausgangssignale gleich (beide sind dann Low Gain).

### **VOLUME (3)**

Regelt den Pegel des "Clean"-Kanals.

### **BRIGHT SWITCH (4)**

Besorgt einen voreingestellten Schub (+6 dB) in den hohen Frequenzen. Zur Aktivierung den Knopf in die "In"-Position drücken.

### **CHANNEL SELECT SWITCH (5)**

Erlaubt die Auswahl des Lead-oder des "Clean"-Kanals. Die "In"-Position des Schalters wählt den Lead-Kanal, die "Out"-Position den "Clean"-Kanal an.

**MERKE:** Kanalwahl kann auch mittels dem Fernbedienungsfußschalter ausgeführt werden. Dazu muß der "Channel"-Schalter sich in der "in" (lead) Position befinden.

### **LOW, MID, & HIGH EQ (6)**

Hierbei handelt es sich um passive Klangregler, die tiefe, mittlere und hohe Frequenzen entsprechend regeln.

### **PRE GAIN (7)**

Kontrolliert den Vorstufenpegel des Lead-Kanals.

### **THRASH SCHALTER (Thrash Switch) (8)**

Ändert den Mittelbereich um etwa 20 dB.

### **GAIN SWITCH (9)**

Boostet die Gesamtlautstärke. Zum Einschalten auf die "In" - Position bringen.

### **LOW, MID, & HIGH EQ (10)**

Hierbei handelt es sich um passive Klangregler, die tiefe, mittlere und hohe Frequenzen entsprechend regeln.

### **POST GAIN (11)**

Kontrolliert den gesamten Lautstärke-pegel des Hauptkanals (Mastervolumen). Die endgültige Lautstärkeregelung sollte vorgenommen werden, nachdem der gewünschte Sound eingestellt ist.

### **REVERB LEVEL (12)**

Regelt den Reverb-Pegel.

### **EFFECTS SEND (13)**

Ausgang für Zuliefersignale zu externen niederohmigen Effekten oder Signal-Prozessoren.

### **EFFECTS RETURN (14)**

Eingang für rückführende Signale von niederohmigen Effekten oder Signal-Prozessoren.

## T.-DYNAMIKREGLER (T. Dynamics Control) (15)

Regelt den Leistungspegel des Verstärkers von 10% bis 100% Leistung. Bei den niedrigeren Einstellungen ist die Simulation der Leistungskompression sehr viel betonter.

## POWER LED (16)

Zeigt die eingeschaltete Netzspannung an.

## POWER SWITCH (Netzschalter)(17)

Bringen Sie den Schalter auf die ON-Position. Die rote Kontrolllampe (LED) leuchtet und zeigt an, daß das Gerät eingeschaltet ist.

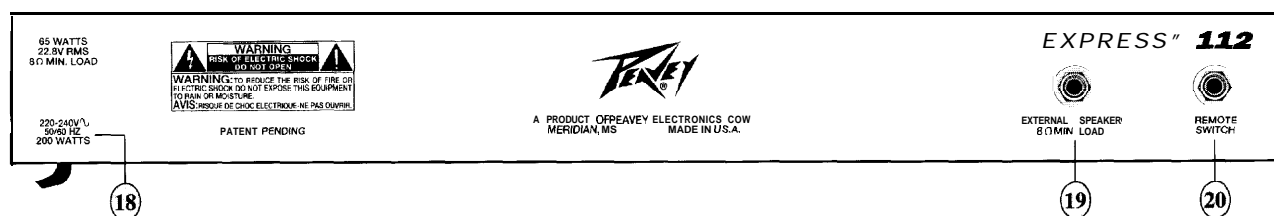

## LINE CORD (120 V products only) (Nur bei 120 Volt-Geräten) (18)

Zu Ihrer Sicherheit haben wir das Gerät mit einem dreidradigen geerdeten Netzkabel versehen. Es ist unter keinen Umständen empfehlenswert den Erdungskontakt des Anschlußkabels zu lösen. Falls es notwendig sein sollte, das Equipment ohne die vorgesehene Erdung zu betreiben empfiehlt sich die Verwendung eines Grounding Adaptors. Die geringsten Störgeräusche und die höchste Sicherheit vor elektrischen Schlägen wird jedoch durch die Benutzung der vorgesehenen Erdungsmöglichkeiten erreicht.

## EXTERNAL SPEAKER JACK (19)

Anschlußbuchse für einen zusätzlichen Lautsprecher. Die minimale Gesamtimpedanz beträgt 8 Ohm. Bei Gebrauch wird der interne Lautsprecher ausgeschaltet.

## REMOTE SWITCH JACK (20)

Vorgesehen für den Anschluß des als Option erhältlichen Fußschalters. Der Fußschalter kann zum Anwählen des Normal- und Leadkanals sowie zum Schalten des Halls verwendet werden. Beim Anschluß des Fußschalters muß der Stecker völlig eingesteckt sein (zweimal Klicken), um die richtige Funktion zu gewährleisten.

**For further information on other Peavey products,  
ask your Authorized Peavey Dealer for the  
appropriate Peavey catalog/publication:**

**Bass Guitars**

**Guitars**

**Bass Amplification**

**Guitar Amplification**

**Sound Reinforcement Enclosures**

**Microphones**

**Keyboards**

**DJ**

**Lighting**

**Mixers, Powered/Non-Powered**

**Accessories/Cables**

**Effects Processors**

**Access™ Wear**

**The Peavey Beat™**

**Monitor@ Magazine**

**Key Issues™**

**Low Down™**

**PM™ Magazine**

**THIS LIMITED WARRANTY VALID ONLY WHEN PURCHASED AND REGISTERED IN THE UNITED STATES OR CANADA. ALL EXPORTED PRODUCTS ARE SUBJECT TO WARRANTY AND SERVICES TO BE SPECIFIED AND PROVIDED BY THE AUTHORIZED DISTRIBUTOR FOR EACH COUNTRY.**

**Ces clauses de garantie ne sont valables qu'aux Etats-Unis et au Canada. Dans tous les autres pays, les clauses de garantie et de maintenance sont fixées par le distributeur national et assurées par lui selon la législation en vigueur.**

**Diese Garantie ist nur in den USA und Kanada gültig. Alle Export-Produkte sind der Garantie und dem Service des Importeurs des jeweiligen Landes unterworfen. Esta garantía es válida solamente cuando el producto es comprado en E.U. continentales o en Canada. Todos los productos que sean comprados en el extranjero, están sujetos a las garantías y servicio que cada distribuidor autorizado determine y ofrezca en los diferentes países.**

**PEAVEY ONE-YEAR LIMITED WARRANTY/REMEDY**

PEAVEY ELECTRONICS CORPORATION ("PEAVEY") warrants this product, EXCEPT for covers, footswitches, patchcords, tubes and meters, to be free from defects in material and workmanship for a period of one (1) year from date of purchase, PROVIDED, however, that this limited warranty is extended only to the original retail purchaser and is subject to the conditions, exclusions, and limitations hereinafter set forth:

**PEAVEY 90-DAY LIMITED WARRANTY ON TUBES AND METERS**

If this product contains tubes or meters, Peavey warrants the tubes or meters contained in the product to be free from defects in material and workmanship for a period of ninety (90) days from date of purchase; PROVIDED, however, that this limited warranty is extended only to the original retail purchaser and is also subject to the conditions, exclusions, and limitations hereinafter set forth.

**CONDITIONS, EXCLUSIONS, AND LIMITATIONS OF LIMITED WARRANTIES**

These limited warranties shall be void and of no effect, if:

- a. The first purchase of the product is for the purpose of resale; or
- b. The original retail purchase is not made from an AUTHORIZED PEAVEY DEALER; or
- c. The product has been damaged by accident or unreasonable use, neglect, improper service or maintenance, or other causes not arising out of defects in material or workmanship; or
- d. The serial number affixed to the product is altered, defaced, or removed.

In the event of a defect in material and/or workmanship covered by this limited warranty, Peavey will:

- a. In the case of tubes or meters, replace the defective component without charge.
- b. In other covered cases (i.e., cases involving anything other than covers, footswitches, patchcords, tubes or meters), repair the defect in material or workmanship or replace the product, at Peavey's option; and provided, however, that, in any case, all costs of shipping, if necessary, are paid by you, the purchaser.

THE WARRANTY REGISTRATION CARD SHOULD BE ACCURATELY COMPLETED AND MAILED TO AND RECEIVED BY PEAVEY WITHIN FOURTEEN (14) DAYS FROM THE DATE OF YOUR PURCHASE.

In order to obtain service under these warranties, you must:

- a. Bring the defective item to any PEAVEY AUTHORIZED DEALER or AUTHORIZED PEAVEY SERVICE CENTER and present therewith the ORIGINAL PROOF OF PURCHASE supplied to you by the AUTHORIZED PEAVEY DEALER in connection with your purchase from him of this product.  
If the DEALER or SERVICE CENTER is unable to provide the necessary warranty service you will be directed to the nearest other PEAVEY AUTHORIZED DEALER or AUTHORIZED PEAVEY SERVICE CENTER which can provide such service.

**OR**

- b. Ship the defective item, prepaid, to:

PEAVEY ELECTRONICS CORPORATION  
International Service Center  
326 Hwy. 11 & 80 East  
MERIDIAN, MS 39301

including therewith a complete, detailed description of the problem, together with a legible copy of the original PROOF OF PURCHASE and a complete return address. Upon Peavey's receipt of these items:

If the defect is remedial under these limited warranties and the other terms and conditions expressed herein have been complied with, Peavey will provide the necessary warranty service to repair or replace the product and will return it, FREIGHT COLLECT, to you, the purchaser.

Peavey's liability to the purchaser for damages from any cause whatsoever and regardless of the form of action, including negligence, is limited to the actual damages up to the greater of \$500.00 or an amount equal to the purchase price of the product that caused the damage or that is the subject of or is directly related to the cause of action. Such purchase price will be that in effect for the specific product when the cause of action arose. This limitation of liability will not apply to claims for personal injury or damage to real property or tangible personal property allegedly caused by Peavey's negligence. Peavey does not assume liability for personal injury or property damage arising out of or caused by a non-Peavey alteration or attachment, nor does Peavey assume any responsibility for damage to interconnected non-Peavey equipment that may result from the normal functioning and maintenance of the Peavey equipment.

UNDER NO CIRCUMSTANCES WILL PEAVEY BE LIABLE FOR ANY LOST PROFITS, LOST SAVINGS, ANY INCIDENTAL DAMAGES, OR ANY CONSEQUENTIAL DAMAGES ARISING OUT OF THE USE OR INABILITY TO USE THE PRODUCT, EVEN IF PEAVEY HAS BEEN ADVISED OF THE POSSIBILITY OF SUCH DAMAGES.

THESE LIMITED WARRANTIES ARE IN LIEU OF ANY AND ALL WARRANTIES, EXPRESSED OR IMPLIED, INCLUDING, BUT NOT LIMITED TO, THE IMPLIED WARRANTIES OF MERCHANTABILITY AND FITNESS FOR A PARTICULAR USE; PROVIDED, HOWEVER, THAT IF THE OTHER TERMS AND CONDITIONS NECESSARY TO THE EXISTENCE OF THE EXPRESSED, LIMITED WARRANTIES, AS HEREINABOVE STATED, HAVE BEEN COMPLIED WITH, IMPLIED WARRANTIES ARE NOT DISCLAIMED DURING THE APPLICABLE ONE-YEAR OR NINETY-DAY PERIOD FROM DATE OF PURCHASE OF THIS PRODUCT.

SOME STATES DO NOT ALLOW LIMITATION ON HOW LONG AN IMPLIED WARRANTY LASTS, OR THE EXCLUSION OR LIMITATION OF INCIDENTAL OR CONSEQUENTIAL DAMAGES, SO THE ABOVE LIMITATIONS OR EXCLUSIONS MAY NOT APPLY TO YOU. THESE LIMITED WARRANTIES GIVE YOU SPECIFIC LEGAL RIGHTS, AND YOU MAY ALSO HAVE OTHER RIGHTS WHICH MAY VARY FROM STATE TO STATE.

THESE LIMITED WARRANTIES ARE THE ONLY EXPRESSED WARRANTIES ON THIS PRODUCT, AND NO OTHER STATEMENT, REPRESENTATION, WARRANTY, OR AGREEMENT BY ANY PERSON SHALL BE VALID OR BINDING UPON PEAVEY.

In the event of any modification or disclaimer of expressed or implied warranties, or any limitation of remedies, contained herein conflicts with applicable law, then such modification, disclaimer or limitation, as the case may be, shall be deemed to be modified to the extent necessary to comply with such law.

Your remedies for breach of these warranties are limited to those remedies provided herein and Peavey Electronics Corporation gives this limited warranty only with respect to equipment purchased in the United States of America.

**INSTRUCTIONS -WARRANTY REGISTRATION CARD**

1. Mail the completed WARRANTY REGISTRATION CARD to:

PEAVEY ELECTRONICS CORPORATION  
POST OFFICE BOX 2898  
MERIDIAN, MISSISSIPPI 39302-2898

- a. Keep the PROOF OF PURCHASE. In the event warranty service is required during the warranty period, you will need this document. There will be no identification card issued by Peavey Electronics Corporation.
2. IMPORTANCE OF WARRANTY REGISTRATION CARDS AND NOTIFICATION OF CHANGES OF ADDRESSES:
  - a. Completion and mailing of WARRANTY REGISTRATION CARDS - Should notification become necessary for any condition that may require correction, the REGISTRATION CARD will help ensure that you are contacted and properly notified.
  - b. Notice of address changes - If you move from the address shown on the WARRANTY REGISTRATION CARD, you should notify Peavey of the change of address so as to facilitate your receipt of any bulletins or other forms of notification which may become necessary in connection with any condition that may require dissemination of information or correction.
3. You may contact Peavey directly by telephoning (601) 483-5365.

## IMPORTANT SAFETY INSTRUCTIONS

**WARNING:** When using electric products, basic cautions should always be followed, including the following.

1. Read all safety and operating instructions before using this product.
2. All safety and operating instructions should be retained for future reference.
3. Obey all cautions in the operating instructions and on the back of the unit.
4. All operating instructions should be followed.
5. This product should not be used near water, i.e., a bathtub, sink, swimming pool, wet basement, etc.
6. This product should be located so that its position does not interfere with its proper ventilation. It should not be placed flat against a wall or placed in a built-in enclosure that will impede the flow of cooling air.
7. This product should not be placed near a source of heat such as a stove, radiator, or another heat producing amplifier.
8. Connect only to a power supply of the type marked on the unit adjacent to the power supply cord.
9. Never break off the ground pin on the power supply cord. For more information on grounding, write for our free booklet "Shock Hazard and Grounding."
10. Power supply cords should always be handled carefully. Never walk or place equipment on power supply cords. Periodically check cords for cuts or signs of stress, especially at the plug and the point where the cord exits the unit.
11. The power supply cord should be unplugged when the unit is to be unused for long periods of time.
12. If this product is to be mounted in an equipment rack, rear support should be provided.
13. Metal parts can be cleaned with a damp rag. The vinyl covering used on some units can be cleaned with a damp rag or an ammonia-based household cleaner if necessary. Disconnect unit from power supply before cleaning.
14. Care should be taken so that objects do not fall and liquids are not spilled into the unit through the ventilation holes or any other openings.
15. This unit should be checked by a qualified service technician if:
  - a. The power supply cord or plug has been damaged.
  - b. Anything has fallen or been spilled into the unit.
  - c. The unit does not operate correctly.
  - d. The unit has been dropped or the enclosure damaged.
16. The user should not attempt to service this equipment. All service work should be done by a qualified service technician.
17. This product should be used only with a cart or stand that is recommended by Peavey Electronics.
18. Exposure to extremely high noise levels may cause a permanent hearing loss. Individuals vary considerably in susceptibility to noise induced hearing loss, but nearly everyone will lose some hearing if exposed to sufficiently intense noise for a sufficient time. The U.S. Government's Occupational Safety and Health Administration (OSHA) has specified the following permissible noise level exposures.

Duration Per Day In Hours	Sound Level dBA, Slow Response
8	90
6	92
4	95
3	97
2	100
1 1/2	102
1	105
1/2	110
1/4 or less	115

According to OSHA, any exposure in excess of the above permissible limits could result in some hearing loss.

Ear plugs or protectors in the ear canals or over the ears must be worn when operating this amplification system in order to prevent a permanent hearing loss if exposure is in excess of the limits as set forth above. To ensure against potentially dangerous exposure to high sound pressure levels, it is recommended that all persons exposed to equipment capable of producing high sound pressure levels such as this amplification system be protected by hearing protectors while this unit is in operation.

**SAVE THESE INSTRUCTIONS!**



Features and specifications subject to change without notice.



## Free Manuals Download Website

<http://myh66.com>

<http://usermanuals.us>

<http://www.somanuals.com>

<http://www.4manuals.cc>

<http://www.manual-lib.com>

<http://www.404manual.com>

<http://www.luxmanual.com>

<http://aubethermostatmanual.com>

Golf course search by state

<http://golfingnear.com>

Email search by domain

<http://emailbydomain.com>

Auto manuals search

<http://auto.somanuals.com>

TV manuals search

<http://tv.somanuals.com>