

ROCK MASTER®

TUBE GUITAR PREAMP

OPERATING GUIDE





Intended to alert the user to the presence of uninsulated “dangerous voltage” within the product’s enclosure that may be of sufficient magnitude to constitute a risk of electric shock to persons.



Intended to alert the user to the presence of important operating and maintenance (servicing) instructions in the literature accompanying the product.

CAUTION Risks of electrical shock — DO NOT OPEN

CAUTION To reduce the risk of electric shock, do not remove cover. No user serviceable parts inside. Refer Servicing to qualified service personnel.

WARNING To prevent electrical shock or fire hazard, do not expose this appliance to rain or moisture. Before using this appliance, read the operating guide for further warnings.



Este símbolo tiene el propósito de alertar al usuario de la presencia de instrucciones importantes sobre la operación y mantenimiento en la literatura que viene con el producto.



Este símbolo tiene el propósito de alertar al usuario de la presencia de “(voltaje) peligroso” que no tiene aislamiento dentro de la caja del producto que puede tener una magnitud suficiente como para constituir riesgo de corrientazo.

PRECAUCION Riesgo de corrientazo - No abra.

PRECAUCION Para disminuir el riesgo de corrientazo, no abra la cubierta. No hay piezas adentro que el usuario pueda reparar. Deje todo mantenimiento a los técnicos calificados.

ADVERTENCIA Para evitar corrientazos o peligro de incendio, no deje expuesto a la lluvia o humedad este aparato. Antes de usar este aparato, lea más advertencias en la guía de operación.



Ce symbole est utilisé pour indiquer à l'utilisateur qu'il ou qu'elle trouvera d'importantes instructions sur l'utilisation et l'entretien (service) de l'appareil dans la littérature accompagnant le produit.



Ce symbole est utilisé pour indiquer à l'utilisateur la présence à l'intérieur de ce produit de tension non-isolée dangereuse pouvant être d'intensité suffisante pour constituer un risque de choc électrique.

ATTENTION Risques de choc électrique — NE PAS OUVRIR!

ATTENTION Afin de réduire le risque de choc électrique, ne pas enlever le couvercle. Il ne se trouve à l'intérieur aucune pièce pouvant être réparée par l'utilisateur. Confier l'entretien à un personnel qualifié.

AVERTISSEMENT Afin de prévenir les risques de décharge électrique ou de feu, n'exposez pas cet appareil à la pluie ou à l'humidité. Avant d'utiliser cet appareil, lisez les avertissements supplémentaires situés dans le guide d'utilisation.



Dieses Symbol soll den Benutzer auf wichtige Instruktionen in der Bedienungsanleitung aufmerksam machen, die Handhabung und Wartung des Produkts betreffen.



Dieses Symbol soll den Anwender vor unisolierten gefährlichen Spannungen innerhalb des Gehäuses warnen, die von Ausreichender Stärke sind, um einen elektrischen Schlag verursachen zu können.

VORSICHT Risiko - Elektrischer Schlag! Nicht öffnen!

VORSICHT Um das Risiko eines elektrischen Schlages zu vermeiden, nicht die Abdeckung entfernen. Es befinden sich keine Teile darin, die vom Anwender repariert werden könnten. Reparaturen nur von qualifiziertem Fachpersonal durchführen lassen.

ACHTUNG Um einen elektrischen Schlag oder Feuergefahr zu vermeiden, sollte dieses Gerät nicht dem Regen oder Feuchtigkeit ausgesetzt werden. Vor Inbetriebnahme unbedingt die Bedienungsanleitung lesen.

ENGLISH

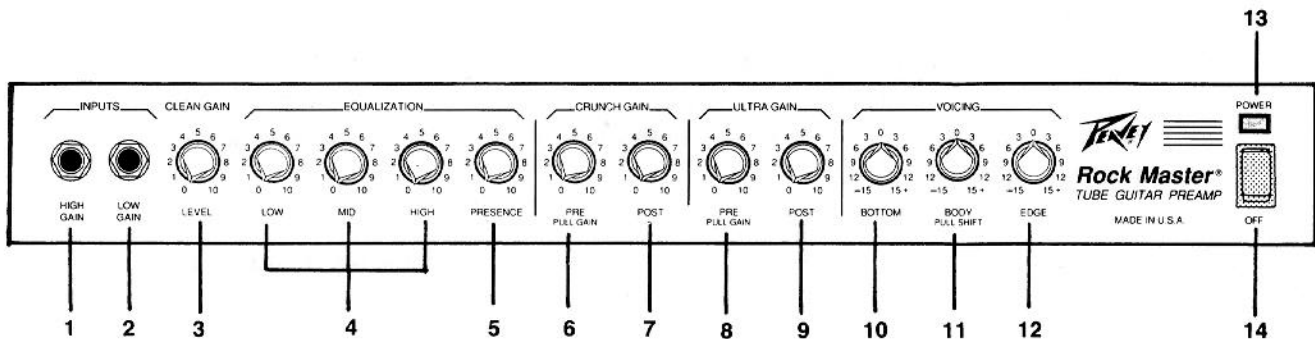

HIGH GAIN INPUT (1)

Used for most electric guitars. It is 6 dB louder than the Low Gain input.

LOW GAIN INPUT (2)

Provided for instruments that have extremely high outputs, which can result in overdriving (distorting) the High Gain input. If both inputs are used simultaneously, the output levels are the same (both are Low Gain).

LEVEL (3)

Controls the volume level of the Clean channel and is not affected by the post gain controls.

LOW, MID, & HIGH EQ (4)

Passive tone controls that regulate the low, mid and high frequencies, respectively.

PRESENCE (5)

An active tone control that boosts the extreme high frequencies by 6 dB.

PRE GAIN/PULL GAIN SWITCH (CRUNCH) (6)

Controls the input volume level of the Crunch channel. Pull Gain switch boosts Crunch channel gain. Push "in" to defeat.

POST GAIN (7)

Controls the overall volume level of the Crunch channel. The final level adjustment should be made after the desired sound has been achieved.

PRE GAIN/PULL GAIN SWITCH (ULTRA) (8)

Controls the input volume level of the Ultra channel. Pull Gain switch boosts Ultra channel gain. Push "in" to defeat.

POST GAIN (9)

Controls the overall volume level of the Ultra channel. The final level adjustment should be made after the desired sound has been achieved.

BOTTOM (10)

An active tone control (shelving type ± 15 dB) that varies the low frequency boost or cut.

NOTE: This control is not functional on the Normal channel.

BODY/PULL SHIFT (11)

An active tone control (peak/notch, ± 15 dB) that varies the mid frequency boost or cut.

NOTE: This control is not functional on the normal channel. Pull shift switch shifts the frequency at which the “Body” control operates. The “out” position allows the Body control to function at a higher frequency and the “in” position selects a lower frequency.

EDGE (12)

An active tone control (shelving type, ± 15 dB) that varies the high frequency boost or cut.

NOTE: This control is not functional on the Normal channel.

POWER LED (13)

Illuminates when AC power is being supplied to the amp.

POWER SWITCH (14)

Depress the switch to the “On” position. The red pilot light (LED) will illuminate indicating power is being supplied to the unit.

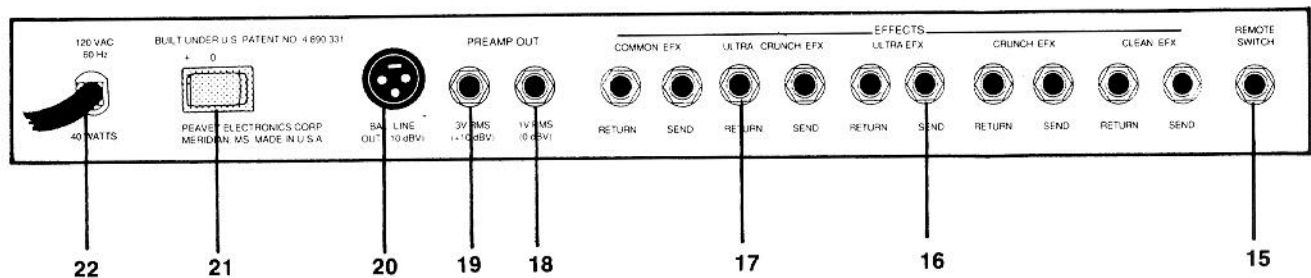

REMOTE SWITCH (15)

Provided for the connection of the supplied remote footswitch. Footswitch is used to select the Ultra Gain, Crunch Gain, or Normal Channels.

EFFECTS PATCHING SECTION:

The RockMaster offers the most complete effects patching of any guitar amplification system we have ever produced. Notice there are send and return patch points for each channel separately, one for the Ultra/Crunch channels and a common patch point that is after all of the preamp functions. The send and return levels have been optimized to work with “low-level” signal processors such as floor pedals and will also function properly with rack-mounted processors. The selection of effects devices is up to you and the patch points provide the capability to place the effect virtually anywhere in the signal flow chain.

EFX SEND (16)

Output for supplying signals to external low-level effects or signal processing equipment.

EFX RETURN (17)

Input for returning signals from external low-level effects or signal processing equipment.

PREAMP OUT (1 VOLT) (18)

A preamp output that can be used to route the preamp signal to a power amplifier, tape recorder, mixing console, effects device, etc. Connect from the preamp output jack to the input of the outboard device.

PREAMP OUT (3 VOLTS) (19)

A preamp output that can be used to route the preamp signal to a power amplifier, crossover, etc. This output provides a 3 volt signal level to drive "tube" power amplifiers and should not be used as an effects send to signal processors or effects devices.

BALANCED OUTPUT (20)

Provides 600 ohm, transformer balanced signal to be used as "direct" patch into mixing consoles, tape recorders, etc. The signal at this point has been frequency compensated for low noise operation.

GROUND SWITCH (21)

Three position rocker-type switch which, in most applications, should be operated in its center or zero position. There may be some situations when audible hum and/or noise will come from the loudspeaker. If this situation arises, position the ground switch to either positive or negative (+ or -) or until the noise is minimized.

NOTE: Should the noise problem continue, consult your Authorized Peavey Dealer, the Peavey Factory, or a qualified service technician. **THE GROUND SWITCH IS NOT FUNCTIONAL ON 220/240 VOLT MODELS.**

LINE CORD (120V PRODUCTS ONLY) (22)

For your safety, we have incorporated a 3-wire line (mains) cable with proper grounding facilities. It is not advisable to remove the ground pin under any circumstances. If it is necessary to use the equipment without proper grounding facilities, suitable grounding adaptors should be used. Less noise and greatly reduced shock hazard exists when the unit is operated with the proper grounded receptacles.

SPECIFICATIONS

The following specs are measured @ 1 kHz with the controls preset as follows:

Low & High EQ @ 10, Mid EQ @ 0, Presence @ 0
Ultra & Crunch Posts @ 10
Bottom, Body, & Edge @ 0 dB
Pull Gains out (On), Body Shift out (On)
(Nominal levels are with Pre Gains @ 5)
(Minimum levels are with Pre Gains @ 10)

Preamp High Gain Input:

Impedance: Very high Z,
470 K ohm

ULTRA CHANNEL:
(Default Channel)

Nominal Input Level: -74 dBV,
0.2 mV RMS

Minimum Input Level:
-80 dBV, 0.1 mV RMS

CRUNCH CHANNEL:
(Footswitch selected)

Nominal Input Level: -70 dBV,
0.3 mV RMS

Minimum Input Level:
-76 dBV, 0.15 mV RMS

CLEAN CHANNEL:
(Footswitch selected)

Nominal Input Level: -20 dBV,
100 mV RMS

Minimum Input Level:

-30 dBV, 30 mV RMS

Maximum Input Level: 0 dBV,
1.0 V RMS

Preamp Low Gain Input: (-6 dB Pad)

Impedance: High Z, 44 K ohms
All levels are increased by
+6 dB

Effects Send:

Load Impedance: 47 K ohms
or greater
Nominal Output: -10 dBV,
300 mV RMS
(Clean, Crunch, Ultra,
Ultra/Crunch, and Common)

Effects Return:

Impedance: Very high Z,
470 K ohm
Designed Level: -10 dBV,
300 mV RMS
(Clean, Crunch, Ultra,
Ultra/Crunch, and Common)

Preamp Output (3 V RMS):

Load Impedance: 47 K ohms or
greater
Nominal Output: +10 dBV,
3 V RMS

Preamp Output (1 V RMS):

Load Impedance: 47 K ohms or
greater
Nominal Output: +0 dBV,
1 V RMS

Line Output:

Load Impedance: 600 ohms or
greater
Nominal Output: -10 dBV,
0.3 V RMS (Transformer
balanced, XLR output)

Remote Footswitch:

Special 2 button unit with LED
indicators (supplied)

System Hum & Noise @ Nominal Level: (Clean Channel)

Equalization: (Clean channel only)

Custom Low, Mid, & High
passive type EQ
Active Presence: +6 dB @
5 kHz

Voicing (Ultra and Crunch Channels Only):

Active Bottom, Body (with Pull
Shift), and Edge EQ
Pull Gain: Increases gain in
Ultra and Crunch channels

TONE SETTINGS

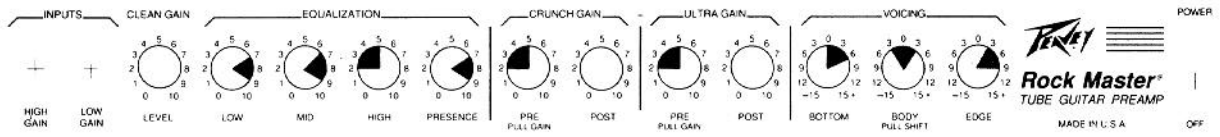

ADJUST TO TASTE

JAZZ

ADJUST TO TASTE

ADJUST TO TASTE

COUNTRY LEAD

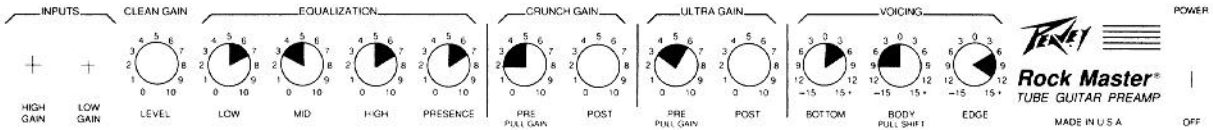

ADJUST TO TASTE

BLUES CLEAN

ADJUST TO TASTE

ACTIVATE GAIN

ADJUST TO TASTE

BLUES LEAD

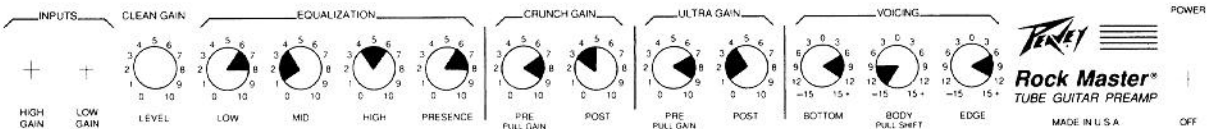

ADJUST TO TASTE

RHYTHM CLEAN

ACTIVATE GAIN

ACTIVATE SHIFT

METAL LEAD

Tone settings given are general and will vary according to type of guitar, type and gauges of strings, type of pickup and even type of pick. Personal taste, playing style, and type of music greatly contribute to desired tonality.

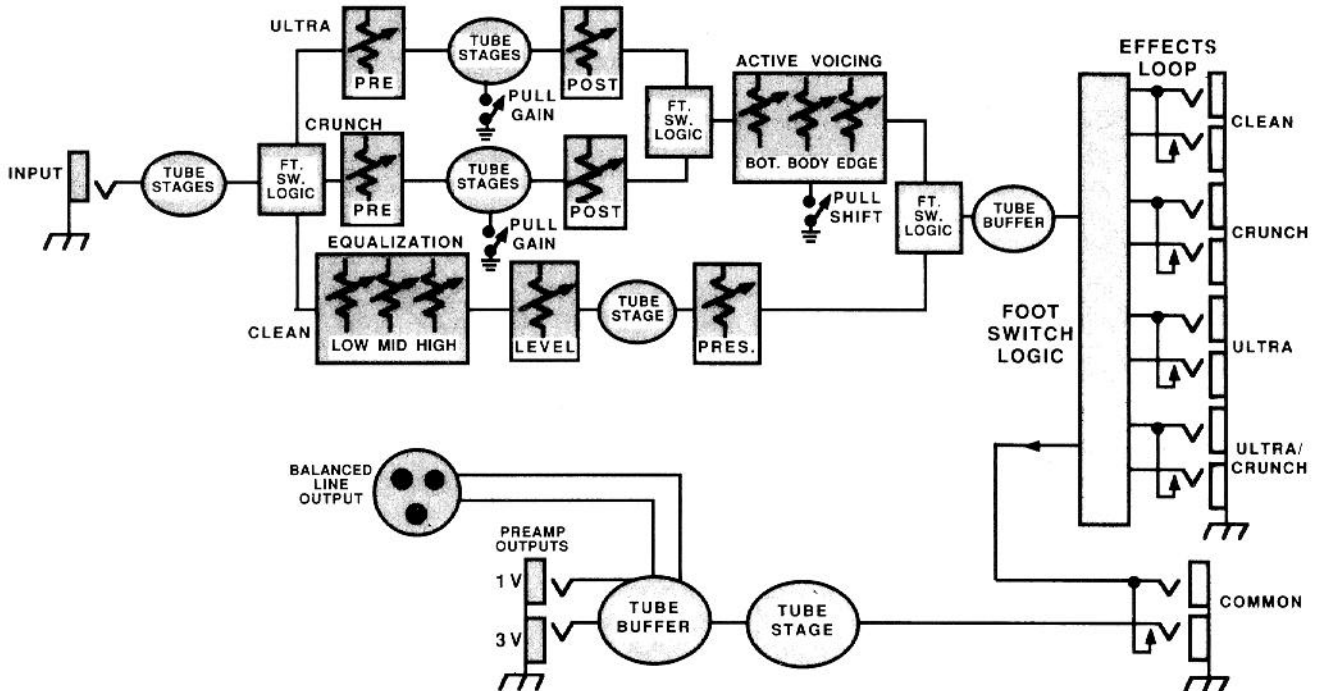

ESPAÑOL

Consulte los diagramas del panel delantero en la sección de inglés de este manual.

HIGH GAIN INPUT (Entrada de ganancia alta) (1)

Se usa para la mayoría de las guitarras eléctricas. Tiene 6 dB más volumen que la entrada de baja ganancia.

LOW GAIN INPUT (Entrada de baja ganancia) (2)

Se suministra para instrumentos que tienen una salida extremadamente alta, la cual puede causar la sobrecarga (distorsión) de la entrada de alta ganancia. Si se usan ambas entradas simultáneamente, el nivel de salida es el mismo (ambos son de baja ganancia).

LEVEL (Nivel) (3)

Controla el nivel de volumen del canal "Limpio" y no lo afectan los controles de ganancia posterior.

LOW, MID, & HIGH EQ (Ecuador de frecuencias graves, medias, y agudas) (4)

Controles de tono pasivo que regulan las frecuencias graves, medias, y altas, respectivamente.

PRESENCE (Presencia) (5)

Control de tono activo que aumenta en 6 dB las frecuencias de los extremos agudos.

PRE GAIN/PULL GAIN SWITCH (CRUNCH)

(Interruptor de preganancia-control que se tira para obtener más ganancia (Crujido) (6)

Controla el nivel de volumen de la entrada del canal "Crunch". Este interruptor que proporciona ganancia al tirarlo, aumenta la ganancia del canal de "Crunch". Oprímalo hacia adentro para desactivarlo.

POST GAIN (Control de ganancia posterior al preamplificador) (7)

Controla el nivel global de volumen del canal "Crunch". El ajuste final de nivel debe hacerse una vez que se haya conseguido el sonido deseado.

PRE GAIN/PULL GAIN SWITCH (ULTRA)

(Interruptor de preganancia-control que se tira para obtener más ganancia (Ultra) (8)

Controla el nivel de volumen de la entrada del canal Ultra. Este interruptor que proporciona ganancia al tirarlo, aumenta la ganancia del canal Ultra. Oprímalo hacia adentro para desactivarlo.

POST GAIN (Ganancia posterior) (9)

Controla el nivel general de volumen del canal Ultra. Se debe hacer el ajuste final de nivel después de que haya obtenido el sonido deseado.

BOTTOM (Fondo) (10)

Un control activo de tono (tipo "repisa" ± 15 dB) que varía el impulso o la reducción de las frecuencias graves.

NOTA: Este control no es capaz de funcionar en el canal normal.

BODY/PULL SHIFT (Control que se tira para desplazar el tono) (11)

Un control de tono activo (gradual, ± 15 dB) que varía el impulso o reducción de frecuencias medias.

NOTA: Este control no funciona en el canal normal. El interruptor que se tira para lograr desplazamiento desplaza la frecuencia en la que opera el control de "grueso". La posición "out" (hacia afuera) permite al control de grueso funcionar en una frecuencia más alta y la posición "in" (hacia adentro) selecciona una frecuencia más baja.

EDGE (Extremo) (12)

Un control activo de tono (tipo “repisa” ± 15 dB) que varía el impulso o la reducción de las frecuencias agudas.

NOTA: Este control no es capaz de funcionar en el canal normal.

POWER LED (LED indicador de corriente) (13)

Se ilumina cuando el amplificador recibe corriente alterna.

POWER SWITCH (Interruptor de corriente) (14)

Oprima el interruptor a la posición “hacia dentro” (encendido). La luz roja del piloto (indicador) se encenderá indicando que la unidad está recibiendo corriente alterna.

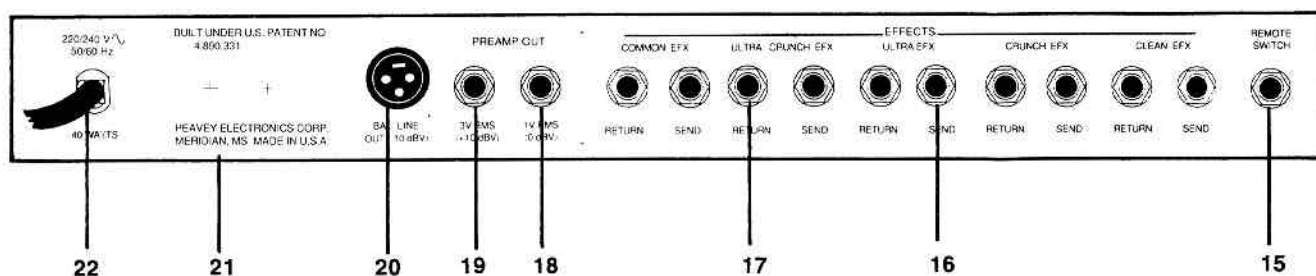

REMOTE SWITCH (Enchufe hembra del pedal interruptor de control remoto) (15)

Se suministra para la conexión del pedal interruptor de control remoto. El pedal se utiliza para seleccionar los canales de Ultra Ganancia, Ganancia de Crujido, o Normal.

EFFECTS PATCHING SECTION (Sección de puenteo de efectos):

El RockMaster ofrece el puenteo de efectos más completo de cualquier sistema de amplificación de guitarra que jamás hayamos fabricado. Fíjese que hay puntos de puenteo de envío y retorno para cada canal separadamente, uno para los canales “ultra/crunch” y un punto común de puenteo que está ubicado después de todas las funciones de preamplificación. Los niveles de envío y retorno se han refinado al máximo para funcionar con procesadores de señales de “bajo nivel” tales como pedales, y también funcionarán correctamente con procesadores montados en rieles de bastidor. La selección de los aparatos de efectos depende de Ud. Los puntos de enlace proporcionan la capacidad de colocar el efecto prácticamente en cualquier lugar en la cadena de flujo de la señal.

EFX SEND (Envío de efectos) (16)

Salida para proporcionar señales a efectos exteriores de bajo nivel o a equipos procesadores de señal.

EFX RETURN (Retorno de efectos) (17)

Entrada para el retorno de señales procedentes de equipos de efectos externos de bajo nivel o de procesadores de señal.

PREAMP OUT (1 VOLT) (Salida del preamplificador, 1 voltio) (18)

Esta es una salida del preamplificador que puede usarse para enviar la señal del preamplificador a un amplificador de potencia, grabadora, consola de mezcla, aparato de efectos, etc. Conecte la salida del enchufe hembra del preamplificador a la entrada del aparato externo.

PREAMP OUT (3 VOLTS) (19)

Esta salida es una salida del preamplificador que puede usarse para enviar la señal del preamplificador a un amplificador de potencia, divisor de frecuencias, etc. Esta salida proporciona un nivel de señal de 3 voltios para impulsar amplificadores de potencia de tubos y no debe usarse como envío de efectos a procesadores de señales o aparatos de efectos.

BALANCED OUTPUT (Salida de línea balanceada) (20)

Proporciona una señal de 600 ohms, balanceada por transformador, para ser utilizada como conexión "directa" a consolas de mezclas, grabadoras, etc. La señal en este punto ha sido compensada en sus frecuencias para obtener un funcionamiento con bajos niveles de ruido.

GROUND SWITCH (Interruptor de tierra) (21)

Un interruptor tipo balancín de tres posiciones que, en la mayoría de las aplicaciones, debe ser operado en su posición del centro o cero (0). Puede haber situaciones cuando un zumbido audible salga del altavoz. Si esta situación ocurre, ajuste la posición del interruptor de tierra a positivo o negativo (+ o -) o hasta que el ruido disminuya.

NOTA: Si el problema de ruido continúa, consulte su representante autorizado de Peavey, la fábrica de Peavey, o un técnico de servicio calificado. EL INTERRUPTOR DE TIERRA NO FUNCIONA EN LOS MODELOS DE 220/240 VOLTIOS.

LINE CORD (120 V PRODUCTS ONLY) (Cable de corriente para 120 v solamente) (22)

Para su protección hemos incorporado un cable de 3 polos con polo a tierra. No es recomendable remover la pata del polo a tierra bajo ninguna circunstancia, se recomienda un adaptador en caso necesario. Esto reducirá ruidos y peligrosos corrientazos.

FRANÇAIS

**Veillez vous référer au “front panel line art”
situé dans la section en langue anglaise de ce manuel.**

HIGH GAIN INPUT (Entrée haut gain) (1)

Cette prise s'utilise avec la plupart des guitares électriques. Elle donne un gain supérieur de 6dB à l'entrée “Low Gain”.

LOW GAIN INPUT (Entrée faible Gain) (2)

Cette prise accepte les instruments à très haut niveau de sortie qui causeraient de la saturation (distorsion) sur l'entrée “High Gain”. Si les deux entrées sont utilisées simultanément, les niveaux sont alors équivalents (“Low Gain”).

LEVEL (Niveau) (3)

Contrôle le niveau de volume du canal “Clean” et n'est pas affecté par les commandes “Post Gain”.

LOW, MID, & HIGH EQ (Égalisation graves, moyennes et aiguës) (4)

Réglages de tonalité passifs réglant respectivement les fréquences graves, moyennes et aiguës.

PRESENCE (Présence) (5)

Réglage de tonalité actif qui renforce les fréquences extrêmes aiguës (+6 dB).

PRE GAIN/PULL GAIN SWITCH (CRUNCH) (Sélecteur Pré Gain/Gain) (6)

Contrôle le niveau de volume d'entrée du canal “Crunch”. Tirer sur le commutateur “Gain Boost” hausse la valeur de gain du canal “Crunch”. Enfoncer pour mettre hors service.

POST GAIN (7)

Commande le volume général du canal “Crunch”. Le réglage final de niveau doit être effectué après avoir obtenu la sonorité désirée à l'aide des autres réglages.

PRE GAIN/PULL GAIN SWITCH (CRUNCH) (Sélecteur Pré Gain/Gain) (8)

Contrôle le niveau de volume d'entrée du canal “Ultra”. Tirer sur le commutateur “Gain Boost” hausse la valeur de gain du canal “Ultra”. Enfoncer pour mettre hors service.

POST GAIN (9)

Contrôle le niveau de volume global du canal “Ultra”. L'ajustement final doit être fait après avoir obtenu la sonorité désirée à l'aide des autres réglages.

BOTTOM (Graves) (10)

Réglage de tonalité actif (type passe bas, ± 15 dB) faisant varier la coupure ou l'amplification des fréquences graves.

NOTE: Cette commande ne fonctionne pas sur le canal “Normal”.

BODY/PULL SHIFT (11)

Bouton de réglage de tonalité actif (correction ± 15 dB) faisant varier la coupure ou l'amplification des moyennes fréquences.

NOTE: Cette commande est inactive sur le canal “Normal”. Tirer sur le bouton fait varier la fréquence affectée par la commande “Body”. La position “Out” de ce commutateur permet à la commande “Body” de contrôler une fréquence plus aiguë et la position “In” sélectionne une fréquence plus grave.

EDGE (Aigus) (12)

Bouton de réglage de tonalité actif (type passe haut, ± 15 dB) faisant varier la coupure ou l'amplification des hautes fréquences.

NOTE: Cette commande ne fonctionne pas sur le canal "Normal".

POWER LED (DEL témoin de mise sous tension) (13)

S'allume lorsque l'ampli reçoit l'alimentation CA.

POWER SWITCH (Interrupteur d'alimentation) (14)

Mettre l'interrupteur en position "On". La lampe témoin rouge (DEL) s'illumine indiquant que l'appareil est alimenté en courant.

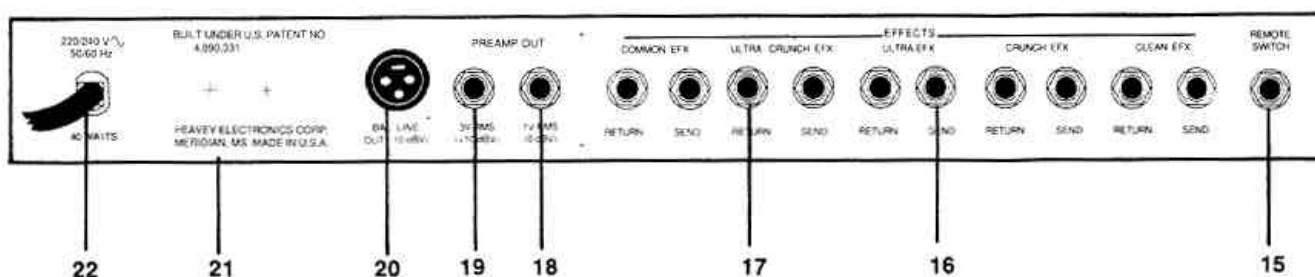

REMOTE SWITCH (Jack pour interrupteur au pied) (15)

Permet de brancher la commande à distance incluse. L'interrupteur au pied est utilisé pour sélectionner les canaux "Ultra Gain", "Crunch Gain", ou "Normal".

EFFECTS PATCHING SECTION (Section d'insertion d'effets):

Le "RockMaster" possède la section d'insertion d'effets la plus complète de tous les systèmes d'amplification de guitare que nous ayons produit. Chaque canal possède ses propres points d'envoi ("send") et de retour ("return"), un pour les canaux "Ultra/Crunch" et un point d'insertion commun situé après toutes les fonctions du préampli. Les niveaux d'envoi et de retour sont optimisés pour fonctionner avec les appareils de traitement à bas niveau ("low-level") tels que les pédales et fonctionnent aussi avec les appareils de traitements montés en rack. Le choix des appareils d'effets est libre à vous et les points d'insertion permettent d'introduire pratiquement n'importe quel effet dans le flot du signal.

EFX SEND (Envoi d'effets) (16)

Prise de sortie servant à fournir des signaux à des appareils externes de traitement de signal ou d'effets à bas niveau.

EFX RETURN (Retour d'effets) (17)

Prise d'entrée pour signaux provenant d'appareils externes de traitement de signal ou d'effets à bas niveau.

PREAMP OUT (1 VOLT) (Sortie préampli 1 volt) (18)

Sortie de préampli utilisée pour envoyer le signal du préampli à un amplificateur de puissance, un magnétophone, une console de mixage, des appareils d'effets, etc. Reliez la sortie du préampli à l'entrée de l'appareil externe.

PREAMP OUT (3 Volts) (19)

Sortie de préamplificateur pouvant être utilisée pour envoyer le signal du préamplificateur à un amplificateur de puissance, filtre ("crossover"), etc. Cette sortie produit un signal de niveau de 3 volts destiné aux amplificateurs de puissance à lampe ("tube") et ne doit pas être utilisée comme envoi d'effet à des appareils d'effets ou de traitement de signal.

BALANCED OUTPUT (Sortie de ligne symétrique) (20)

Fournit un signal de 600 ohms équilibré par transformateur pour un branchement "direct" dans une console de mixage, un magnétophone, etc. Sur cette sortie, les fréquences sont compensées de façon à assurer un bas niveau de bruit d'utilisation.

GROUND SWITCH (Sélecteur de mise à terre) (21)

Commutateur rotatif à trois positions devant, la plupart du temps, être en position centrale (zéro). Dans certaines situations un bruit de ronflement ou un bourdonnement audible peut provenir des haut-parleurs de puissance. Dans ce cas, bougez le sélecteur de mise à terre jusqu'en position positive ou négative (+ ou -) ou jusqu'à ce que le bruit diminue.

NOTE: Si le problème de bruit persiste, consultez votre détaillant autorisé Peavey, la fabrique Peavey, ou un technicien de service qualifié. LE SÉLECTEUR DE MISE À TERRE NE FONCTIONNE PAS SUR LES APPAREILS 220/240 VOLT.

LINE CORD (120V products only) (Cordon d'alimentation pour appareils 120V seulement) (22)

Pour votre sécurité, nous avons incorporé un câble d'alimentation secteur à 3 fils avec mise-à-terre appropriée. Il n'est pas recommandé d'enlever la broche de mise-à-terre en aucune circonstance. S'il est nécessaire d'utiliser l'équipement sans mise-à-terre appropriée, utilisez des adaptateurs de mise-à-terre convenables. Une bonne mise-à-terre amoindrit le bruit de fond et réduit grandement les risques de choc.

DEUTSCH

Siehe diagramm der frontplatte im englischen teil des handbuchs.

HIGH GAIN INPUT (1)

Dieser Eingang kann für die meisten elektrischen Gitarren verwendet werden. Er ist 6 dB empfindlicher als der Low Gain Input.

LOW GAIN INPUT (2)

Dieser Eingang ist für die Instrumente vorgesehen, die ein besonders hohes Ausgangssignal erzeugen. Falls beide Eingänge gleichzeitig benutzt werden, sind die Ausgangssignale gleich (beide sind dann Low Gain).

LEVEL (3)

Regelt den Pegel des "Clean"-Kanals und wird nicht von den Post-Gain-Reglern beeinflusst.

LOW, MID & HIGH EQ (4)

Hierbei handelt es sich um passive Klangregler, die tiefe, mittlere und hohe Frequenzen entsprechend regeln.

PRESENCE (5)

Eine aktive Tonkontrolle, welche die extrem hohen Frequenzen um 6 dB boostet (anhebt).

PRE GAIN/PULL GAIN SWITCH (CRUNCH) (6)

Regelt die Eingangslautstärke des Crunch-Kanals. Der Pull Gain-Schalter boostet den Gain des Crunch-Kanals. Zum Ausschalten "in" drücken.

POST GAIN (7)

Regelt die Gesamtlautstärke des Crunch-Kanals. Eine endgültige Pegeleinstellung sollte erfolgen, wenn der gewünschte Sound erreicht wurde.

PRE GAIN/PULL GAIN SWITCH (ULTRA) (8)

Regelt die Eingangslautstärke des Ultra-Kanals. Der Pull Gain-Schalter boostet den Gain des Ultra-Kanals. Zum Ausschalten "in" drücken.

POST GAIN (9)

Regelt die Gesamtlautstärke des Ultra-Kanals. Die Feineinstellung sollte erfolgen, nachdem der gewünschte Sound erzielt wurde.

BOTTOM (10)

Eine aktive Tonkontrolle (± 15 dB), die die Low Frequenz boostet oder abschneidet.

MERKE: Diese Funktion arbeitet nicht auf dem Normal-Kanal.

BODY/PULL SHIFT (11)

Ein aktiver Klangregler (peak/notch, ± 15 dB), der die Mittenfrequenzen anhebt oder absenkt.

MERKE: Dieser Regler wirkt nicht auf den Normal Kanal. Herausziehen (Pull) des Reglers verlagert den Frequenzbereich, in dem der "Body" Regler arbeitet. In der "out" Position arbeitet der Regler in einem höheren Frequenzbereich als er es in der "in" Position tut.

EDGE (12)

Eine aktive Tonkontrolle (± 15 dB), die die High Frequenz boostet oder abschneidet.

MERKE: Diese Funktion arbeitet nicht auf dem Normal-Kanal.

POWER LED (13)

Zeigt die eingeschaltete Netzspannung an.

POWER SWITCH (Netzschalter) (14)

Bringen Sie den Schalter auf die ON-Position. Die rote Kontrolllampe (LED) leuchtet und zeigt an, daß das Gerät eingeschaltet ist.

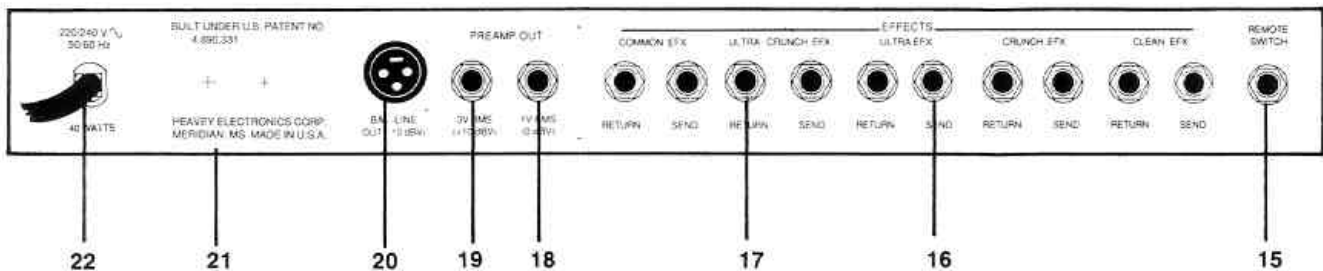

REMOTE SWITCH (15)

Zum Anschluß des mitgelieferten Fußschalters. Dieser dient zur Anwahl von Ultra Gain, Crunch Gain oder Normal Channels.

EFX PATCHING SECTION:

Der RockMaster bietet das aufwendigste Effekt-Verschaltungssystem das wir je produziert haben. Es gibt separate Send- und Return-Buchsen für jeden einzelnen Kanal, einen für die Ultra/Crunch Kanäle und eine universelle Buchse, die hinter allen Preamp-Funktionen liegt. Die Send- und Return-Pegel wurden optimiert, damit sie auch "kleine" Signale von Bodeneffektgeräten verarbeiten können und arbeiten auch korrekt mit 19-Zoll Effektgeräten. Die Wahl der Effektgeräte obliegt dem Anwender, und die diversen Buchsen ermöglichen den Anschluß der Geräte praktisch überall in der Signalkette.

EFX SEND (16)

Ausgang für Zuliefersignale zu externen niederohmigen Effekten oder Signal-Prozessoren.

EFX RETURN (17)

Eingang für rückführende Signale von niederohmigen Effekten oder Signal-Prozessoren.

PREAMP OUT (1 VOLT) (18)

Ein Preampausgang, der dazu verwendet werden kann, um das Preamp Signal einer Endstufe, Bandmaschine, Mischpult, Effektgerät oder ähnliches zuzuführen. Dazu die Preamp Ausgangsbuchse mit der Eingangsbuchse des externen Geräts verbinden.

PREAMP OUT (3 VOLT) (19)

Ein Preamp-Ausgang, der dazu verwendet werden kann, das Signal vom Preamp zu einem weiteren Poweramp, Crossover etc. zu leiten. Dieser Ausgang liefert ein 3 Volt Signal um z.B. Röhrenendstufen zu betreiben und darf nicht als "Effekt-Send" für Effektgeräte verwendet werden.

BALANCED OUTPUT (20)

Liefert 600 ohm; transformer-symmetrisches Signal, um als "Direkt"-Anschluß an Mixer, Tonbandgeräte usw. benutzt zu werden. Das Signal an diesem Punkt wurde frequenz-kompensiert für rauscharme Arbeitsweise.

GROUND SWITCH (21)

Der Ground-Schalter funktioniert nicht bei den 220/240 Volt-Modellen.

LINE CORD (120V products only) (Nur bei 120 Volt-Geräten) (22)

Zu Ihrer Sicherheit haben wir das Gerät mit einem dreiadrigen geerdeten Netzkabel versehen. Es ist unter keinen Umständen empfehlenswert den Erdungskontakt des Anschlußkabels zu lösen. Falls es notwendig sein sollte, das Equipment ohne die vorgesehene Erdung zu betreiben empfiehlt sich die Verwendung eines Grounding Adaptors. Die geringsten Störgeräusche und die höchste Sicherheit vor elektrischen Schlägen wird jedoch durch die Benutzung der vorgesehenen Erdungsmöglichkeiten erreicht.

For further information on other Peavey products, ask your Authorized Peavey Dealer for the appropriate Peavey catalog/publication.



Guitars
Guitar Amplification
Bass Guitars
Bass Amplification
Sound Reinforcement Enclosures
Microphones
Keyboards
DJ
Mixers, Powered/Non-Powered
Accessories/Cables
Effects Processors
Axxess™ Wear
Monitor® Magazine
Key Issues™

IMPORTANT SAFETY INSTRUCTIONS

WARNING When using electric products, basic cautions should always be followed, including the following.

1. Read all safety and operating instructions before using this product.
2. All safety and operating instructions should be retained for future reference.
3. Obey all cautions in the operating instructions and on the back of the unit.
4. All operating instructions should be followed.
5. This product should not be used near water, i.e., a bathtub, sink, swimming pool, wet basement, etc.
6. This product should be located so that its position does not interfere with its proper ventilation. It should not be placed flat against a wall or placed in a built-in enclosure that will impede the flow of cooling air.
7. This product should not be placed near a source of heat such as a stove, radiator, or another heat producing amplifier.
8. Connect only to a power supply of the type marked on the unit adjacent to the power supply cord.
9. Never break off the ground pin on the power supply cord. For more information on grounding, write for our free booklet "Shock Hazard and Grounding."
10. Power supply cords should always be handled carefully. Never walk or place equipment on power supply cords. Periodically check cords for cuts or signs of stress, especially at the plug and the point where the cord exits the unit.
11. The power supply cord should be unplugged when the unit is to be unused for long periods of time.
12. If this product is to be mounted in an equipment rack, rear support should be provided.
13. Metal parts can be cleaned with a damp rag. The vinyl covering used on some units can be cleaned with a damp rag, or an ammonia-based household cleaner if necessary. Disconnect unit from power supply before cleaning.
14. Care should be taken so that objects do not fall and liquids are not spilled into the unit through the ventilation holes or any other openings.
15. This unit should be checked by a qualified service technician if
 - a. The power supply cord or plug has been damaged.
 - b. Anything has fallen or been spilled into the unit.
 - c. The unit does not operate correctly.
 - d. The unit has been dropped or the enclosure damaged.
16. The user should not attempt to service this equipment. All service work should be done by a qualified service technician.
17. This product should be used only with a cart or stand that is recommended by Peavey Electronics.
18. Exposure to extremely high noise levels may cause a permanent hearing loss. Individuals vary considerably in susceptibility to noise induced hearing loss, but nearly everyone will lose some hearing if exposed to sufficiently intense noise for a sufficient time.

The U.S. Government's Occupational Safety and Health Administration (OSHA) has specified the following permissible noise level exposures.

Duration Per Day In Hours	Sound Level dBA, Slow Response
8	90
6	92
4	95
3	97
2	100
1½	102
1	105
½	110
¼ or less	115

According to OSHA, any exposure in excess of the above permissible limits could result in some hearing loss.

Ear plugs or protectors in the ear canals or over the ears must be worn when operating this amplification system in order to prevent a permanent hearing loss if exposure is in excess of the limits as set forth above. To ensure against potentially dangerous exposure to high sound pressure levels, it is recommended that all persons exposed to equipment capable of producing high sound pressure levels such as this amplification system be protected by hearing protectors while this unit is in operation.

SAVE THESE INSTRUCTIONS

THIS LIMITED WARRANTY VALID ONLY WHEN PURCHASED AND REGISTERED IN THE UNITED STATES OR CANADA. ALL EXPORTED PRODUCTS ARE SUBJECT TO WARRANTY AND SERVICES TO BE SPECIFIED AND PROVIDED BY THE AUTHORIZED DISTRIBUTOR FOR EACH COUNTRY.
Ces clauses de garantie ne sont valables qu'aux Etats-Unis et au Canada. Dans tous les autres pays, les clauses de garantie et de maintenance sont fixées par le distributeur national et assurées par lui selon la législation en vigueur. •• Diese Garantie ist nur in den USA und Kanada gültig. Alle Export-Produkte sind der Garantie und dem Service des Importeurs des jeweiligen Landes unterworfen. •• Esta garantía es válida solamente cuando el producto es comprado en E.U. continentales o en Canada. Todos los productos que sean comprados en el extranjero, están sujetos a las garantías y servicio que cada distribuidor autorizado determine y ofrezca en los diferentes países.

PEAVEY ONE-YEAR LIMITED WARRANTY/REMEDY

PEAVEY ELECTRONICS CORPORATION ("PEAVEY") warrants this product, EXCEPT for covers, footswitches, patchcords, tubes and meters, to be free from defects in material and workmanship for a period of one (1) year from date of purchase, PROVIDED, however, that this limited warranty is extended only to the original retail purchaser and is subject to the conditions, exclusions, and limitations hereinafter set forth:

PEAVEY 90-DAY LIMITED WARRANTY ON TUBES AND METERS

If this product contains tubes or meters, Peavey warrants the tubes or meters contained in the product to be free from defects in material and workmanship for a period of ninety (90) days from date of purchase; PROVIDED, however, that this limited warranty is extended only to the original retail purchaser and is also subject to the conditions, exclusions, and limitations hereinafter set forth.

CONDITIONS, EXCLUSIONS, AND LIMITATIONS OF LIMITED WARRANTIES

These limited warranties shall be void and of no effect, if:

- a. The first purchase of the product is for the purpose of resale; or
- b. The original retail purchase is not made from an AUTHORIZED PEAVEY DEALER; or
- c. The product has been damaged by accident or unreasonable use, neglect, improper service or maintenance, or other causes not arising out of defects in material or workmanship; or
- d. The serial number affixed to the product is altered, defaced, or removed.

In the event of a defect in material and/or workmanship covered by this limited warranty, Peavey will:

- a. In the case of tubes or meters, replace the defective component without charge.
- b. In other covered cases (i.e., cases involving anything other than covers, footswitches, patchcords, tubes or meters), repair the defect in material or workmanship or replace the product, at Peavey's option; and provided, however, that, in any case, all costs of shipping, if necessary, are paid by you, the purchaser.

THE WARRANTY REGISTRATION CARD SHOULD BE ACCURATELY COMPLETED AND MAILED TO AND RECEIVED BY PEAVEY WITHIN FOURTEEN (14) DAYS FROM THE DATE OF YOUR PURCHASE.

In order to obtain service under these warranties, you must:

- a. Bring the defective item to any PEAVEY AUTHORIZED DEALER or AUTHORIZED PEAVEY SERVICE CENTER and present therewith the ORIGINAL PROOF OF PURCHASE supplied to you by the AUTHORIZED PEAVEY DEALER in connection with your purchase from him of this product.

If the DEALER or SERVICE CENTER is unable to provide the necessary warranty service you will be directed to the nearest other PEAVEY AUTHORIZED DEALER or AUTHORIZED PEAVEY SERVICE CENTER which can provide such service.

OR

- b. Ship the defective item, prepaid, to:

PEAVEY ELECTRONICS CORPORATION
International Service Center
326 Hwy. 11 & 80 East
Meridian, MS 39301

including therewith a complete, detailed description of the problem, together with a legible copy of the original PROOF OF PURCHASE and a complete return address. Upon Peavey's receipt of these items: If the defect is remedial under these limited warranties and the other terms and conditions expressed herein have been complied with, Peavey will provide the necessary warranty service to repair or replace the product and will return it, FREIGHT COLLECT, to you, the purchaser.

Peavey's liability to the purchaser for damages from any cause whatsoever and regardless of the form of action, including negligence, is limited to the actual damages up to the greater of \$500.00 or an amount equal to the purchase price of the product that caused the damage or that is the subject of or is directly related to the cause of action. Such purchase price will be that in effect for the specific product when the cause of action arose. This limitation of liability will not apply to claims for personal injury or damage to real property or tangible personal property allegedly caused by Peavey's negligence. Peavey does not assume liability for personal injury or property damage arising out of or caused by a non-Peavey alteration or attachment, nor does Peavey assume any responsibility for damage to interconnected non-Peavey equipment that may result from the normal functioning and maintenance of the Peavey equipment.

UNDER NO CIRCUMSTANCES WILL PEAVEY BE LIABLE FOR ANY LOST PROFITS, LOST SAVINGS, LOST SAVINGS, ANY INCIDENTAL DAMAGES, OR ANY CONSEQUENTIAL DAMAGES ARISING OUT OF THE USE OR INABILITY TO USE THE PRODUCT, EVEN IF PEAVEY HAS BEEN ADVISED OF THE POSSIBILITY OF SUCH DAMAGES.

THESE LIMITED WARRANTIES ARE IN LIEU OF ANY AND ALL WARRANTIES, EXPRESSED OR IMPLIED, INCLUDING, BUT NOT LIMITED TO, THE IMPLIED WARRANTIES OF MERCHANTABILITY AND FITNESS FOR A PARTICULAR USE; PROVIDED, HOWEVER, THAT IF THE OTHER TERMS AND CONDITIONS NECESSARY TO THE EXISTENCE OF THE EXPRESSED, LIMITED WARRANTIES, AS HEREINABOVE STATED, HAVE BEEN COMPLIED WITH, IMPLIED WARRANTIES ARE NOT DISCLAIMED DURING THE APPLICABLE ONE-YEAR OR NINETY-DAY PERIOD FROM DATE OF PURCHASE OF THIS PRODUCT.

SOME STATES DO NOT ALLOW LIMITATION ON HOW LONG AN IMPLIED WARRANTY LASTS, OR THE EXCLUSION OR LIMITATION OF INCIDENTAL OR CONSEQUENTIAL DAMAGES, SO THE ABOVE LIMITATIONS OR EXCLUSIONS MAY NOT APPLY TO YOU. THESE LIMITED WARRANTIES GIVE YOU SPECIFIC LEGAL RIGHTS, AND YOU MAY ALSO HAVE OTHER RIGHTS WHICH MAY VARY FROM STATE TO STATE.

THESE LIMITED WARRANTIES ARE THE ONLY EXPRESSED WARRANTIES ON THIS PRODUCT, AND NO OTHER STATEMENT, REPRESENTATION, WARRANTY, OR AGREEMENT BY ANY PERSON SHALL BE VALID OR BINDING UPON PEAVEY.

In the event of any modification or disclaimer of expressed or implied warranties, or any limitation of remedies, contained herein conflicts with applicable law, then such modification, disclaimer or limitation, as the case may be, shall be deemed to be modified to the extent necessary to comply with such law.

Your remedies for breach of these warranties are limited to those remedies provided herein and Peavey Electronics Corporation gives this limited warranty only with respect to equipment purchased in the United States of America.

INSTRUCTIONS — WARRANTY REGISTRATION CARD

1. Mail the completed WARRANTY REGISTRATION CARD to:

PEAVEY ELECTRONICS CORPORATION
P.O. BOX 2898
Meridian, MS 39302-2898

- a. Keep the PROOF OF PURCHASE. In the event warranty service is required during the warranty period, you will need this document. There will be no identification card issued by Peavey Electronics Corporation.
2. IMPORTANCE OF WARRANTY REGISTRATION CARDS AND NOTIFICATION OF CHANGES OF ADDRESSES:
 - a. Completion and mailing of WARRANTY REGISTRATION CARDS — Should notification become necessary for any condition that may require correction, the REGISTRATION CARD will help ensure that you are contacted and properly notified.
 - b. Notice of address changes — If you move from the address shown on the WARRANTY REGISTRATION CARD, you should notify Peavey of the change of address so as to facilitate your receipt of any bulletins or other forms of notification which may become necessary in connection with any condition that may require dissemination of information or correction.
3. You may contact Peavey directly by telephoning (601) 483-5365.



Features and specifications subject to change without notice.



©1994 Peavey Electronics Corporation 711 A Street / Meridian, MS 39301 / U.S.A. / (601) 483-5365 / Fax 486-1278
#80301268 Printed in U.S.A. 6/96

Free Manuals Download Website

<http://myh66.com>

<http://usermanuals.us>

<http://www.somanuals.com>

<http://www.4manuals.cc>

<http://www.manual-lib.com>

<http://www.404manual.com>

<http://www.luxmanual.com>

<http://aubethermostatmanual.com>

Golf course search by state

<http://golfingnear.com>

Email search by domain

<http://emailbydomain.com>

Auto manuals search

<http://auto.somanuals.com>

TV manuals search

<http://tv.somanuals.com>