



# **ALM2064**

## **Alarm Interface Unit**



**C1517M-A (11/02)**

# CONTENTS

<b>Section</b>	<b>Page</b>
IMPORTANT SAFEGUARDS AND WARNINGS .....	3
OVERVIEW .....	4
DESCRIPTION .....	4
FRONT VIEW .....	4
REAR VIEW .....	5
INSTALLATION .....	6
MOUNTING .....	6
CONNECTING TO THE CM6800 .....	6
WIRING ALARMS .....	7
MAKING THE ALARM CONNECTIONS .....	10
WIRING EXTERNAL ALARM INPUTS USING ANALOG CIRCUITRY .....	11
RELAY OUTPUT WIRING .....	12
SETTING THE DIP SWITCHES .....	12
OPERATION .....	14
TROUBLESHOOTING .....	15
APPENDIX A .....	16
SPECIFICATIONS .....	18
REGULATORY NOTICES .....	19
WARRANTY AND RETURN INFORMATION .....	19

## LIST OF ILLUSTRATIONS

<b>Figure</b>	<b>Page</b>
1 Front View of ALM2064 .....	4
2 Rear View of ALM2064 .....	5
3 Rack-Mount Installation .....	6
4 Connection to the CM6800 .....	6
5 DIP Switch Settings for Supervised/Unsupervised Modes .....	7
6 Supervised Alarm Input Wiring .....	8
7 Unsupervised Alarm Input Wiring .....	9
8 Alarm Input Connectors .....	10
9 TTL/CMOS External Alarm Wiring .....	11
10 Relay Output Connector .....	12
11 Front Panel Removal .....	12
12 DIP Switch Location .....	12
13 SW1 & SW2 Functions .....	13
14 Power Input Fuse Replacement .....	15
15 DB9 Pin-Outs .....	15
16 ALM2064 Dimension Diagram .....	18

## LIST OF TABLES

<b>Table</b>	<b>Page</b>
A Switch 1 .....	13
B Switch 2 .....	13

## IMPORTANT SAFEGUARDS AND WARNINGS

1. Read, keep, and follow these instructions.
2. Heed all warnings.
3. There are no user-serviceable parts inside this unit. Only authorized service personnel may open the unit.
4. Installation and servicing should only be done by qualified service personnel and conform to all local codes.
5. **WARNING:** To reduce the risk of fire or electric shock, do not expose this unit to rain or moisture if this unit is designed for indoor use only.
6. Unless this unit is specifically marked as a NEMA Type 3, 3R, 3S, 4, 4X, 6 or 6P enclosure, it is designed for indoor use only and it must not be installed where exposed to rain or moisture.
7. Do not expose this unit to dripping or splashing. Do not place objects filled with liquids, such as vases, on this unit.
8. Do not block any ventilation openings. Install in accordance with the manufacturer's instructions.
9. The installation method and materials should be capable of supporting four times the weight of the unit and equipment.
10. Do not install near any heat source.
11. Only use attachments/accessories specified by the manufacturer.
12. Clean only with dry cloth.
13. Do not defeat the safety purpose of the polarized or grounding-type plug.
14. Protect the power cord from being walked on or pinched, particularly at plugs, convenience receptacles, and the point where they exit from the unit.
15. Unplug this unit during lightning storms or when unused for long periods of time.

The product and/or manual may bear the following marks:



This symbol indicates that dangerous voltage constituting a risk of electric shock is present within this unit.



This symbol indicates that there are important operating and maintenance instructions in the literature accompanying this unit.



Please thoroughly familiarize yourself with the information in this manual prior to installation and operation.

### FOR QUALIFIED SERVICE PERSONNEL ONLY

1. Only use replacement parts recommended by Pelco.
2. After replacement/repair of this unit's electrical components, conduct a resistance measurement between line and exposed parts to verify the exposed parts have not been connected to line circuitry.

# OVERVIEW

## DESCRIPTION

The ALM2064 Alarm Interface Unit provides alarm monitoring capability for up to 64 alarm inputs. Using Pelco's proprietary M protocol, the alarm unit communicates with Pelco's CM6800 matrix switcher via an RS-485 communication interface. The alarm unit can be located remotely from the system controller and still communicate back to the central system when an alarm occurs.

Other features include the following:

- Multiple units can be cascaded to provide multiple alarm contact points on a single M port connection.
- Alarm inputs can be configured in two groups of 32 for supervised or unsupervised mode.
- The relay output activates when an alarm is triggered.
- The unit is powered by an auto-ranging power supply.
- The unit occupies one rack unit (1.75 inches or 4.45 cm), accommodating multiple types of mounting.

## FRONT VIEW

The left side of the front panel includes the green power LED light. This light comes on at power-up.

The right side of the front panel includes the red alarm LED. When the light is a solid red, the alarm unit is online. When the light is off, the unit is offline. In any valid alarm condition, this light starts blinking and only stops when the alarm is no longer active.

When you remove the front panel, you have access to a reset button and configuration DIP switches.

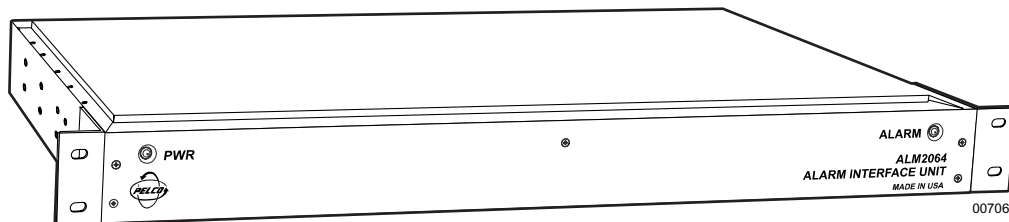
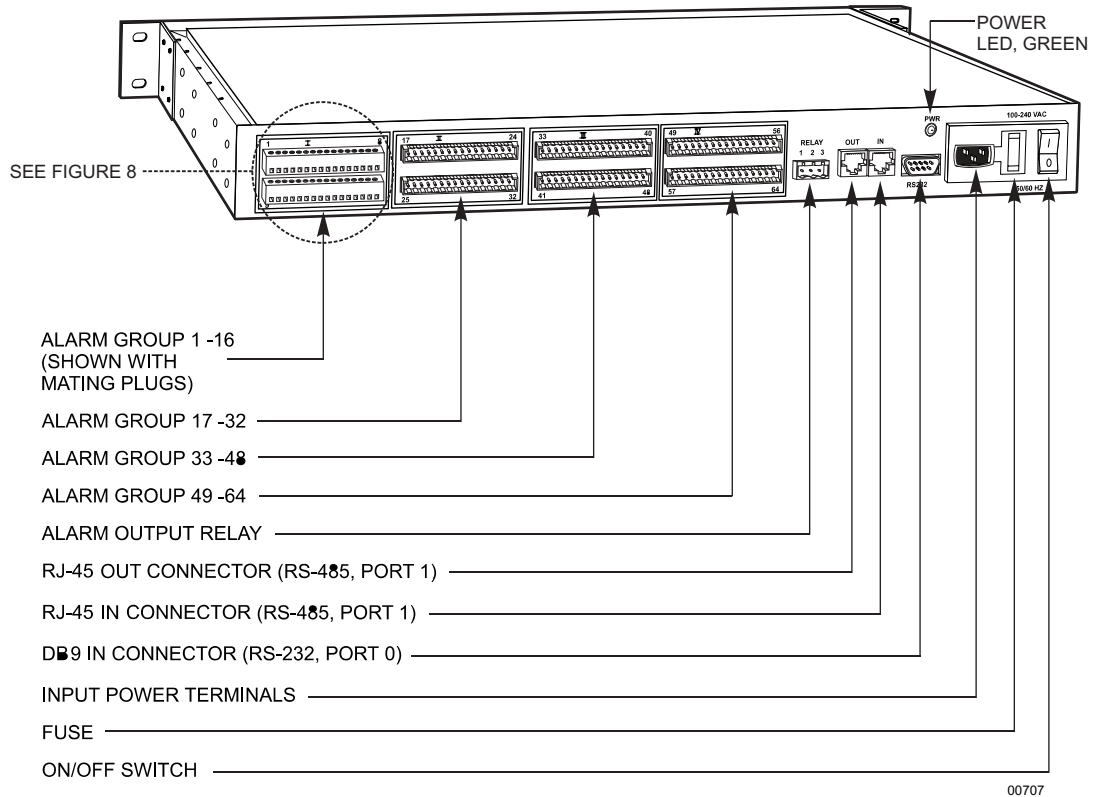

**Figure 1.** Front View of ALM2064

## REAR VIEW

The rear of the alarm unit includes the following:

1. Four groups of alarm inputs (labeled I, II, III, and IV) with removable mating plugs
2. One alarm output relay
3. One RS-485 output communication port (RJ-45 connector)
4. One RS-485 input communication port (RJ-45 connector)
5. One RS-232 diagnostic communication port (DB9 connector)
6. A green power LED light, which mirrors the green LED light on the front panel
7. The grouped input power functions consisting of input power terminals, a fuse, and an on/off switch



**Figure 2.** Rear View of ALM2064

# INSTALLATION

The following items are supplied:

- ALM2064 Alarm Interface Unit
- 120 VAC power cord
- 220 VAC power cord
- Pelco screwdriver
- 4 #10 screws with nylon washers
- 10-foot (3 m) straight RJ-45 cable (8-conductor)

## MOUNTING

Install the alarm unit in a 19-inch (48.26 cm) rack. The unit occupies one rack unit (1.75 inches or 4.45 cm) of space. You can mount the alarm unit to something other than a standard 19-inch rack by relocating the rack ears to another location.

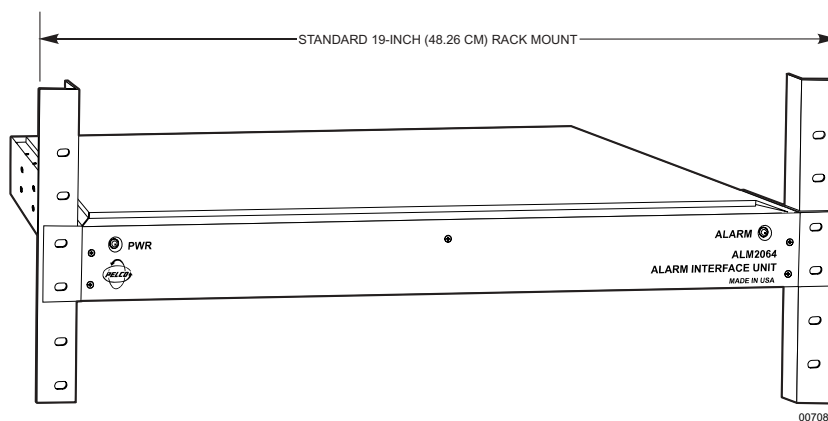

Figure 3. Rack-Mount Installation

## CONNECTING TO THE CM6800

Connect the supplied RJ-45 straight cable from the ALM2064 OUT port to the CM6800 COM 3 port. The active pin-outs are associated with the four outer pins: 1, 2, 7, and 8. Refer to Figure 4.

If you want to place the alarm unit some distance from the CM6800, the RS-485 communication from the alarm unit to the controller should not exceed 4,000 feet (1,219 m). You need an RJ-45 wall-block terminal (part number CON12J008Z03G0Z) if operating from a remote site.

To cascade two alarm units, connect a straight cable from the OUT port of the second alarm unit to the IN port of the first alarm unit. The first unit is the one you connect to the CM6800.

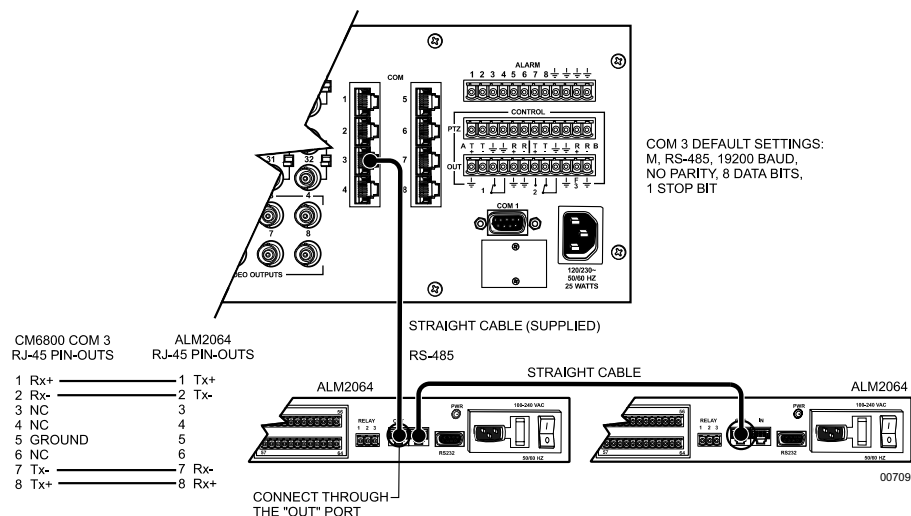

Figure 4. Connection to the CM6800

## WIRING ALARMS

All alarm wiring takes place using the four groups of connectors located on the rear of the alarm unit. The alarm unit has four groups of inputs. Each group represents 16 alarm inputs:

- Group I – 1-8, 9-16
- Group II – 17-24, 25-32
- Group III – 33-40, 41-48
- Group IV – 49-56, 57-64

Each of the four groups of wired alarm inputs are classified into modes (or contact types): supervised and unsupervised. This is important for the following reasons:

1. The operational mode (supervised or unsupervised) for each 32-input group is determined solely by the DIP switch positions of SW1. Refer to Figure 5.
2. Integrating supervised and unsupervised wiring modes within the same group is not allowed.
3. In unsupervised mode, it is not possible to have alarms wired for both normally open and normally closed operation in the same alarm group.
4. If wiring a group of alarm inputs as supervised, no unwired inputs are allowed as this would result in a constant alarm condition. All unwired inputs should have a 10-kohm resistor wired across its input and associated GND connection. Refer to Figure 6.
5. If wiring a group of alarm inputs as unsupervised and normally closed, no unwired inputs are allowed as this would also result in a constant alarm condition. Alarm inputs not used must be shorted out between the alarm input and its associated GND connection. Refer to Figure 7.

### SW1 – SUPERVISED MODE

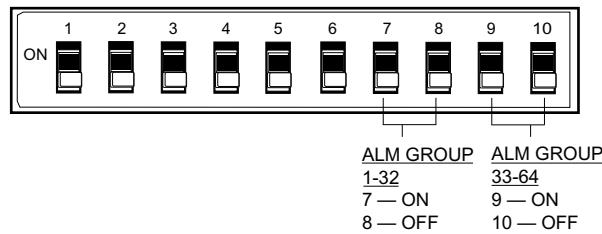

### SW1 – UNSUPERVISED MODE

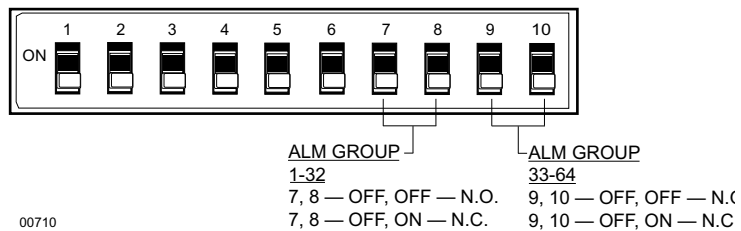

00710

**Figure 5.** DIP Switch Settings for Supervised/Unsupervised Modes

## SUPERVISED MODE

Use this wiring mode if security is of utmost importance. Alarm inputs wired in supervised mode maximize the detection of tampering by driving a constant current through a 10-kohm load. If a deviation in the steady current occurs, the alarm goes off. **Please note that unused inputs must also be wired.** Refer to Figure 6.

### SUPERVISED MODE CONSIDERATIONS

#### INDIVIDUAL ALARM WIRING CONDITIONS

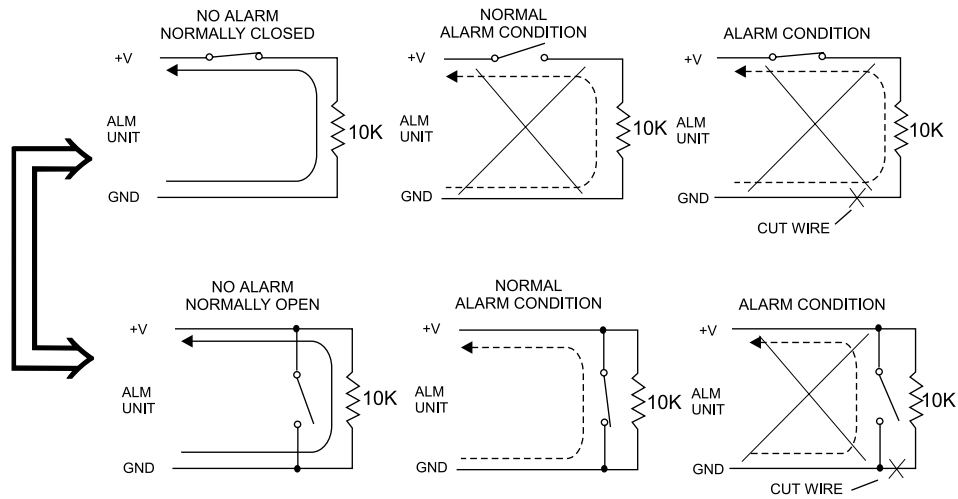

#### SUPERVISED GROUP ALARM WIRING CONDITIONS

##### SUPERVISED, NORMALLY OPEN

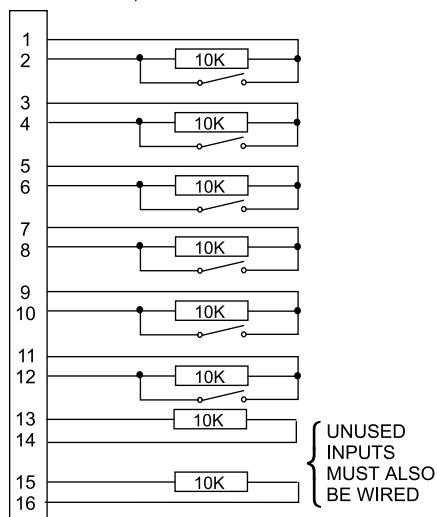

##### SUPERVISED, NORMALLY CLOSED

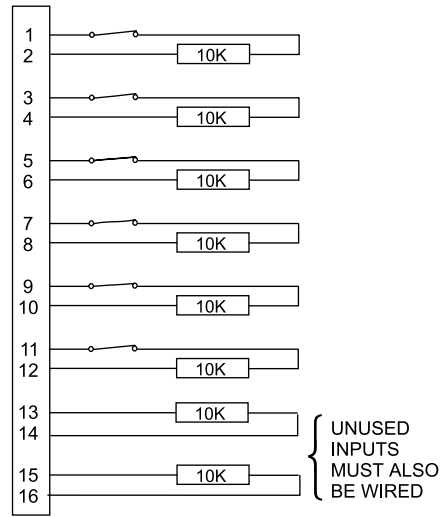

00711

Figure 6. Supervised Alarm Input Wiring



## UNSUPERVISED MODE

This wiring mode is easily defeated and should not be used in critical situations. For example, if you wire an alarm as unsupervised and normally open, and a wire is cut, the alarm does not go off. If wiring for a normally open condition, unused inputs can be left unwired. **If wiring for a normally closed condition, unused inputs must be shorted.** Refer to Figure 7.

### UNSUPERVISED MODE CONSIDERATIONS

#### INDIVIDUAL ALARM WIRING CONDITIONS

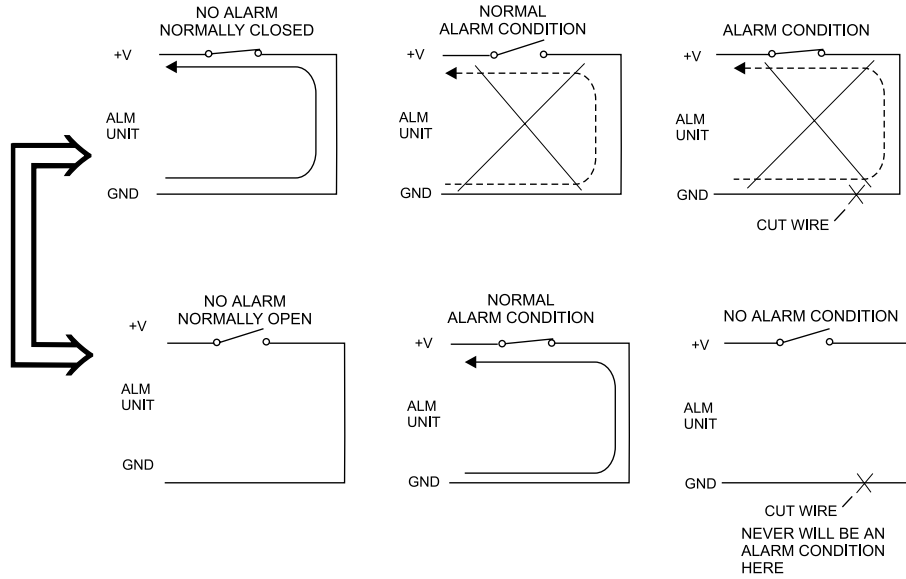

#### UNSUPERVISED GROUP ALARM WIRING CONDITIONS

##### UNSUPERVISED, NORMALLY OPEN

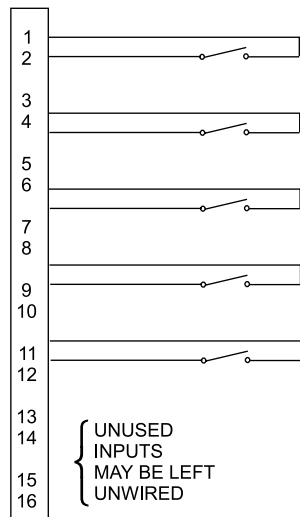

##### UNSUPERVISED, NORMALLY CLOSED

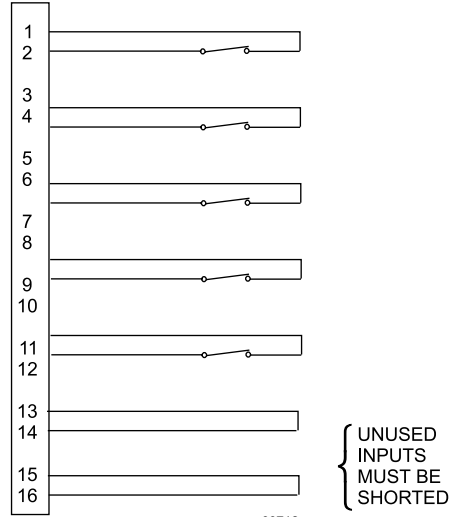

00712

Figure 7. Unsupervised Alarm Input Wiring

## MAKING THE ALARM CONNECTIONS

Each of the four groups contains two connectors with input mating plugs. The top of each mating plug has 16 screw terminals and the front has 16 pins. The figure below indicates how the pins alternate between alarm inputs and their associated GND (ground) input connection. For example, pins 1 and 2 are associated with alarm input 1. This applies to all four groups of alarm inputs.

Remove the mating plugs from the connectors to install the wiring. The top connector of each group is for the first eight alarm inputs, and the bottom connector is for the last eight alarm inputs. The 16 screw terminals secure the alarm wires.

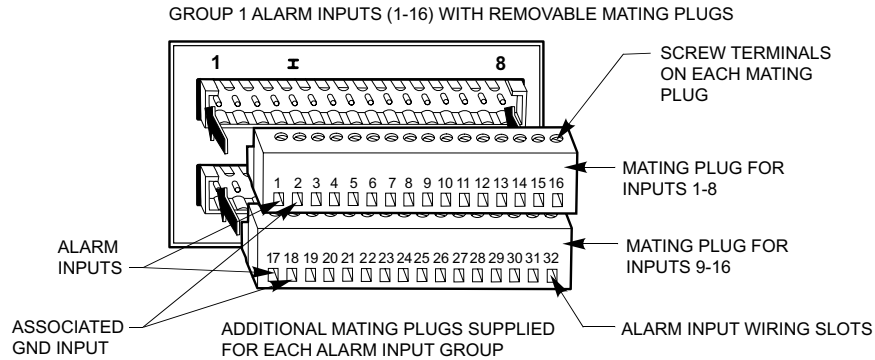

NOTE: THE MATING PLUGS HAVE BEEN NUMBERED (1-16, 17-32) FOR DISCUSSION PURPOSES.

MATING PLUG HEADER PIN #	ALARM INPUT #	MATING PLUG HEADER PIN #	ALARM INPUT #
1	ALARM INPUT 1	17	ALARM INPUT 9
2	GND	18	GND
3	ALARM INPUT 2	19	ALARM INPUT 10
4	GND	20	GND
5	ALARM INPUT 3	21	ALARM INPUT 11
6	GND	22	GND
7	ALARM INPUT 4	23	ALARM INPUT 12
8	GND	24	GND
9	ALARM INPUT 5	25	ALARM INPUT 13
10	GND	26	GND
11	ALARM INPUT 6	27	ALARM INPUT 14
12	GND	28	GND
13	ALARM INPUT 7	29	ALARM INPUT 15
14	GND	30	GND
15	ALARM INPUT 8	31	ALARM INPUT 16
16	GND	32	GND

00713

Figure 8. Alarm Input Connectors

## WIRING EXTERNAL ALARM INPUTS USING ANALOG CIRCUITRY

Figure 9 summarizes what is required in supervised and unsupervised modes to wire external alarm inputs using analog TTL/CMOS circuitry rather than alarms.

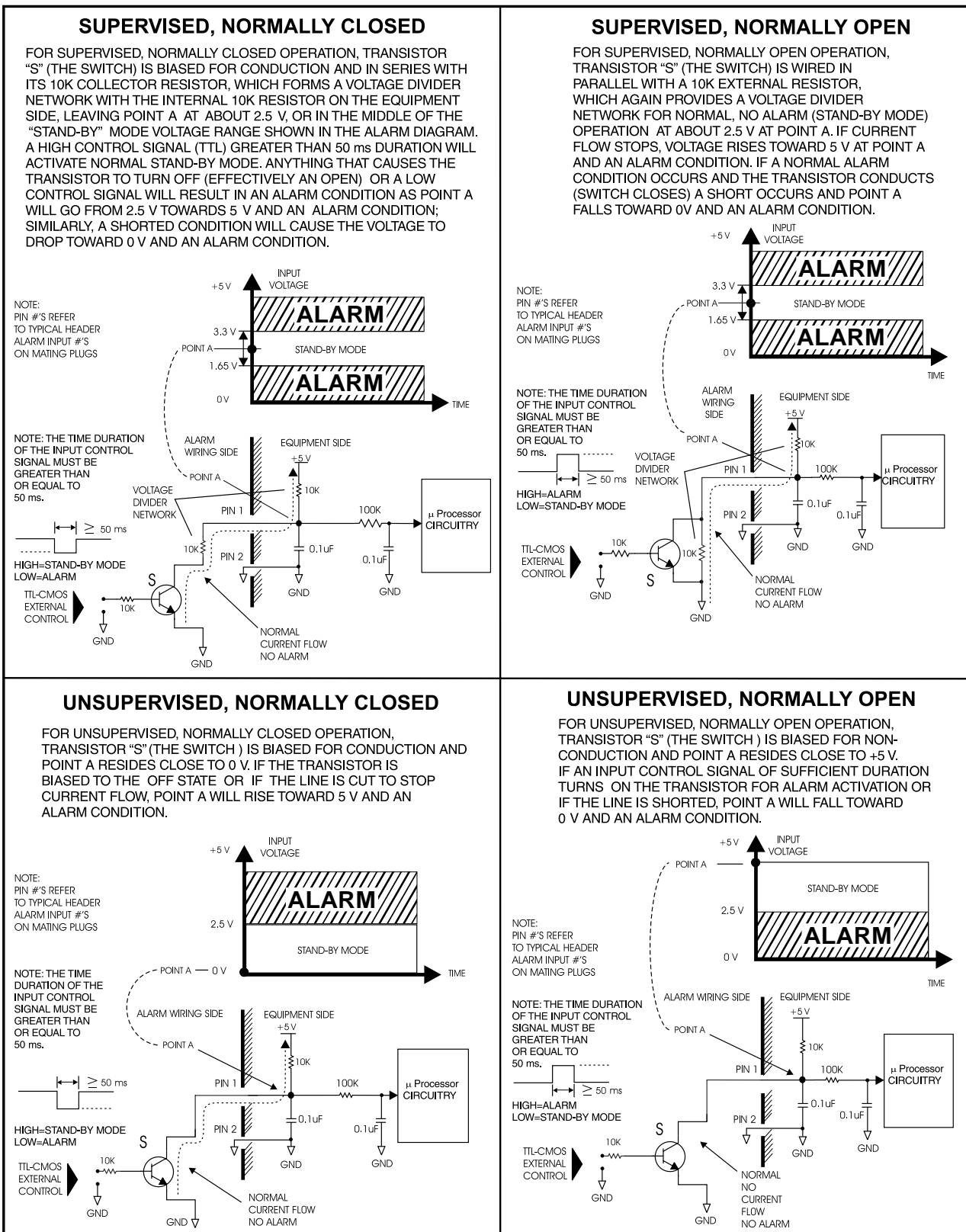

00714

Figure 9. TTL/CMOS External Alarm Wiring

## RELAY OUTPUT WIRING

The alarm unit activates the relay when a valid alarm condition is sensed.

To wire the relay output, you must do the following:

1. Remove the mating plug from the relay output connector.
2. Place the wires into the relay out wiring slots.
3. Tighten the screws to secure the wires.

---

**NOTE:** Refer to the REL2064 Installation/Operation Manual for instructions on wiring relays to peripheral equipment.

---

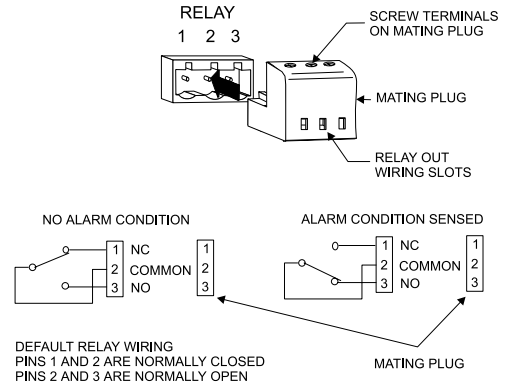

Figure 10. Relay Output Connector

## SETTING THE DIP SWITCHES

The positioning of the DIP switches for SW1 and SW2 determines how your alarm unit operates. You are able to set the baud rate, alarm range, alarm group and mode, and local device address.

---

**NOTE:** You must recycle power if you make changes to the DIP switches after the alarm unit has been turned on.

---

1. Remove the front panel by unscrewing the five flat-head Phillips screws. Refer to Figure 11.
2. Set the DIP switches. Refer to Tables A and B and Figures 12 and 13.
3. Replace the front panel.

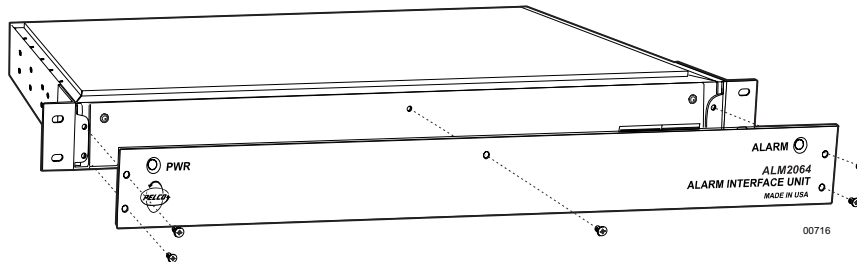

Figure 11. Front Panel Removal

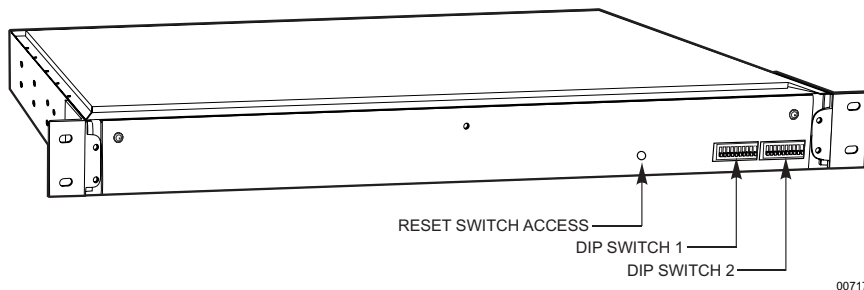

Figure 12. DIP Switch Location

**Table A. Switch 1**

SW1 – Communications/Alarm Type Selection												
Baud				Alarm Range				Alarm Mode	1-32		33-64	
1200	Off	Off	Off	1-64	Off	Off	Off	Norm. Open (Unsupervised)	Off	Off	Off	Off
2400	On	Off	Off	65-128	On	Off	Off					
4800	Off	On	Off	129-192	Off	On	Off	Norm. Closed (Unsupervised)	Off	On	Off	On
9600	On	On	Off	193-256	On	On	Off					
19200	Off	Off	On	257-320	Off	Off	On	Supervised	On	Off	On	Off
38400	On	Off	On	321-384	On	Off	On					
57600	Off	On	On	385-448	Off	On	On	*Default to Norm. Open	On	On	On	On
115200	On	On	On	449	On	On	On					
<b>DIP Switch</b>	<b>1</b>	<b>2</b>	<b>3</b>		<b>4</b>	<b>5</b>	<b>6</b>		<b>7</b>	<b>8</b>	<b>9</b>	<b>10</b>

\*The alarm modes default to normally open when DIP switches 7-10 are set to an invalid condition (all On).

**Table B. Switch 2**

Address	SW2 – Address										
1	Off	Off	Off	Off	Off	Off	Off	Off	Off	Off	Off
2	On	Off	Off	Off	Off	Off	Off	Off	Off	Off	Off
3	Off	On	Off	Off	Off	Off	Off	Off	Off	Off	Off
4	On	On	Off	Off	Off	Off	Off	Off	Off	Off	Off
5	Off	Off	On	Off	Off	Off	Off	Off	Off	Off	Off
6	On	Off	On	Off	Off	Off	Off	Off	Off	Off	Off
7	Off	On	On	Off	Off	Off	Off	Off	Off	Off	Off
8	On	On	On	Off	Off	Off	Off	Off	Off	Off	Off
9	Off	Off	Off	On	Off	Off	Off	Off	Off	Off	Off
10	On	Off	Off	On	Off	Off	Off	Off	Off	Off	Off
11	Off	On	Off	On	Off	Off	Off	Off	Off	Off	Off
12	On	On	Off	On	Off	Off	Off	Off	Off	Off	Off
13	Off	Off	On	On	Off	Off	Off	Off	Off	Off	Off
14	On	Off	On	On	Off	Off	Off	Off	Off	Off	Off
15	Off	On	On	On	Off	Off	Off	Off	Off	Off	Off
16	On	On	On	On	Off	Off	Off	Off	Off	Off	Off
<b>DIP Switch</b>	<b>1</b>	<b>2</b>	<b>3</b>	<b>4</b>	<b>5</b>	<b>6</b>	<b>7</b>	<b>8</b>	<b>9</b>	<b>10</b>	



**SERIAL PORT 1**

**BAUD RATE**

1200: OFF, OFF, OFF  
 2400: ON, OFF, OFF  
 4800: OFF, ON, OFF  
 9600: ON, ON, OFF  
 19200: OFF, OFF, ON  
 38400: ON, OFF, ON  
 57600: OFF, ON, ON  
 115200: ON, ON, ON

**BEGIN ALARM RANGE**

1-64: OFF, OFF, OFF  
 65-128: ON, OFF, OFF  
 129-192: OFF, ON, OFF  
 193-256: ON, ON, OFF  
 257-320: OFF, OFF, ON  
 321-384: ON, OFF, ON  
 385-448: OFF, ON, ON  
 449: ON, ON, ON

**ALARM GROUP 33-64**

N.O. UNSUP: OFF, OFF  
 N.C. UNSUP: OFF, ON  
 SUP: ON, OFF  
 DEFAULT N.O.: ON, ON

**ALARM GROUP 1-32**

N.O. UNSUP: OFF, OFF  
 N.C. UNSUP: OFF, ON  
 SUP: ON, OFF  
 DEFAULT N.O.: ON, ON

N.O. = NORMALLY OPEN  
 N.C. = NORMALLY CLOSED  
 SUP = SUPERVISED  
 UNSUP = UNSUPERVISED

DEFAULT SETTINGS: BAUD 19200, ALARM RANGE 1-64, ALARM GROUPS N.O.

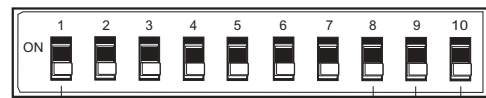

**LOCAL DEVICE ADDRESS**

NOT USED:  
 OFF  
 DIAGNOSTICS: OFF

DEFAULT SETTINGS: LOCAL DEVICE ADDRESS 1, DIP SWITCH 9 OFF, DIP SWITCH 10 ON

**NOTE:** REFER TO APPENDIX A FOR SETTING EACH DEVICE ADDRESS (1-253)

**Figure 13. SW1 & SW2 Functions**

## OPERATION

The function of the alarm unit is to physically monitor all alarm inputs for a change of state.

Green LEDs on the front and rear panels light when the power is turned on.

The red alarm LED indicates whether the unit is offline or online. This light starts blinking in any valid alarm condition and only stops when the alarm is no longer active.

For supervised inputs, the unit monitors each alarm input for a constant current through the wiring of the alarm circuit. The alarm consists of either a 10-kohm resistor connected in series with a normally closed contact or a 10-kohm resistor connected in parallel with a normally open contact.

For unsupervised inputs, the unit monitors each alarm input for a change of state from that previously defined by DIP switch positions as being normally open or normally closed. A change from the defined state (normally open to normally closed or normally closed to normally open) activates an alarm condition.

The alarm unit activates the relay whenever a valid alarm condition is sensed. If multiple alarm points are activated on a given alarm unit, the relay remains engaged as long as any of these alarm conditions remain active.

# TROUBLESHOOTING

PROBLEM	SOLUTION
Why is the unit not operating as it should?	Make sure the power cord is plugged in and the power switch is turned on. If the unit still fails to operate, remove the front panel and press the reset button. Make sure the DIP switch settings are correct. Check the input power fuse. You may need to replace it. Refer to Figure 14.
What is the DB9 port used for?	This port is used for diagnostics. A technical support representative may ask you to enable this feature should a problem arise with the unit. This port is not needed for the every-day operation of the ALM2064.

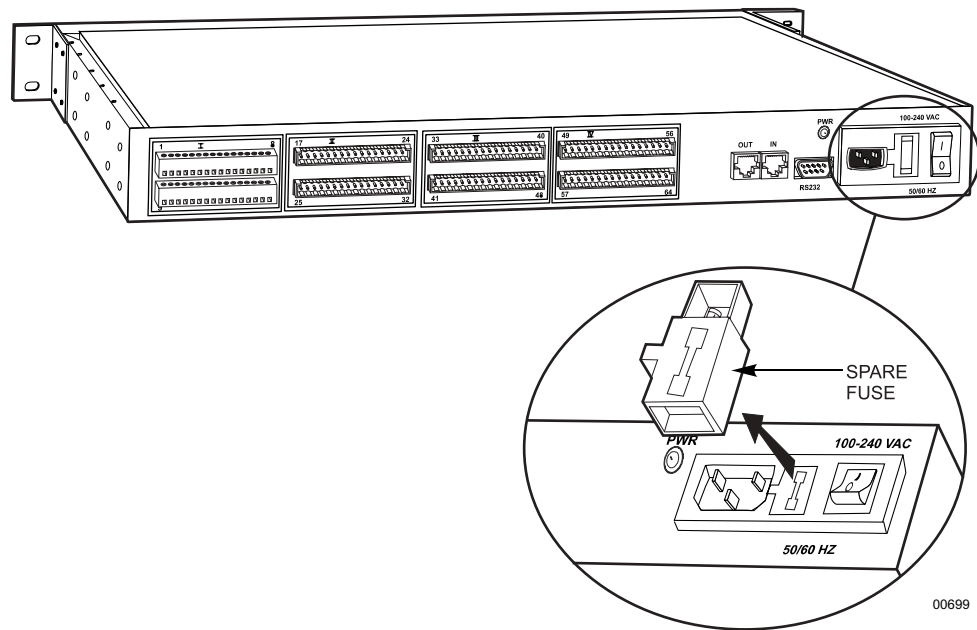

**Figure 14.** Power Input Fuse Replacement

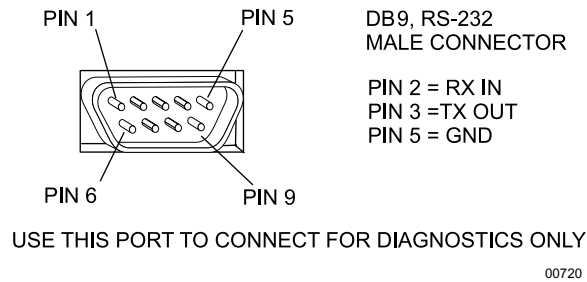

**Figure 15.** DB9 Pin-Outs

# APPENDIX A

Address	DIP Switch							
	1	2	3	4	5	6	7	8
1	0	0	0	0	0	0	0	0
2	1	0	0	0	0	0	0	0
3	0	1	0	0	0	0	0	0
4	1	1	0	0	0	0	0	0
5	0	0	1	0	0	0	0	0
6	1	0	1	0	0	0	0	0
7	0	1	1	0	0	0	0	0
8	1	1	1	0	0	0	0	0
9	0	0	0	1	0	0	0	0
10	1	0	0	1	0	0	0	0
11	0	1	0	1	0	0	0	0
12	1	1	0	1	0	0	0	0
13	0	0	1	1	0	0	0	0
14	1	0	1	1	0	0	0	0
15	0	1	1	1	0	0	0	0
16	1	1	1	1	0	0	0	0
17	0	0	0	0	1	0	0	0
18	1	0	0	0	1	0	0	0
19	0	1	0	0	1	0	0	0
20	1	1	0	0	1	0	0	0
21	0	0	1	0	1	0	0	0
22	1	0	1	0	1	0	0	0
23	0	1	1	0	1	0	0	0
24	1	1	1	0	1	0	0	0
25	0	0	0	1	1	0	0	0
26	1	0	0	1	1	0	0	0
27	0	1	0	1	1	0	0	0
28	1	1	0	1	1	0	0	0
29	0	0	1	1	1	0	0	0
30	1	0	1	1	1	0	0	0
31	0	1	1	1	1	0	0	0
32	1	1	1	1	1	0	0	0
33	0	0	0	0	0	1	0	0
34	1	0	0	0	0	1	0	0
35	0	1	0	0	0	1	0	0
36	1	1	0	0	0	1	0	0
37	0	0	1	0	0	1	0	0
38	1	0	1	0	0	1	0	0
39	0	1	1	0	0	1	0	0
40	1	1	1	0	0	1	0	0
41	0	0	0	1	0	1	0	0
42	1	0	0	1	0	1	0	0
43	0	1	0	1	0	1	0	0
44	1	1	0	1	0	1	0	0
45	0	0	1	1	0	1	0	0
46	1	0	1	1	0	1	0	0
47	0	1	1	1	0	1	0	0
48	1	1	1	1	0	1	0	0
49	0	0	0	0	0	1	0	0
50	1	0	0	0	1	1	0	0
51	0	1	0	0	1	1	0	0
52	1	1	0	0	1	1	0	0
53	0	0	1	0	1	1	0	0
54	1	0	1	0	1	1	0	0
55	0	1	1	0	1	1	0	0
56	1	1	1	0	1	1	0	0
57	0	0	0	1	1	1	0	0
58	1	0	0	1	1	1	0	0
59	0	1	0	1	1	1	0	0
60	1	1	0	1	1	1	0	0
61	0	0	1	1	1	1	0	0
62	1	0	1	1	1	1	0	0

0 = OFF  
1 = ON

Address	DIP Switch							
	1	2	3	4	5	6	7	8
63	0	1	1	1	1	1	0	0
64	1	1	1	1	1	1	0	0
65	0	0	0	0	0	0	1	0
66	1	0	0	0	0	0	1	0
67	0	1	0	0	0	0	1	0
68	1	1	0	0	0	0	1	0
69	0	0	1	0	0	0	1	0
70	1	0	1	0	0	0	1	0
71	0	1	1	0	0	0	1	0
72	1	1	1	0	0	0	1	0
73	0	0	0	1	0	0	1	0
74	1	0	0	1	0	0	1	0
75	0	1	0	1	0	0	1	0
76	1	1	0	1	0	0	1	0
77	0	0	1	1	0	0	1	0
78	1	0	1	1	0	0	1	0
79	0	1	1	1	0	0	1	0
80	1	1	1	1	0	0	1	0
81	0	0	0	0	1	0	1	0
82	1	0	0	0	1	0	1	0
83	0	1	0	0	1	0	1	0
84	1	1	0	0	1	0	1	0
85	0	0	1	0	1	0	1	0
86	1	0	1	0	1	0	1	0
87	0	1	1	0	1	0	1	0
88	1	1	1	0	1	0	1	0
89	0	0	0	1	1	0	1	0
90	1	0	0	1	1	0	1	0
91	0	1	0	1	1	0	1	0
92	1	1	0	1	1	0	1	0
93	0	0	1	1	1	0	1	0
94	1	0	1	1	1	0	1	0
95	0	1	1	1	1	0	1	0
96	1	1	1	1	1	0	1	0
97	0	0	0	0	0	1	1	0
98	1	0	0	0	0	1	1	0
99	0	1	0	0	0	1	1	0
100	1	1	0	0	0	1	1	0
101	0	0	1	0	0	1	1	0
102	1	0	1	0	0	1	1	0
103	0	1	1	0	0	1	1	0
104	1	1	1	0	0	1	1	0
105	0	0	0	1	0	1	1	0
106	1	0	0	1	0	1	1	0
107	0	1	0	1	0	1	1	0
108	1	1	0	1	0	1	1	0
109	0	0	1	1	0	1	1	0
110	1	0	1	1	0	1	1	0
111	0	1	1	1	0	1	1	0
112	1	1	1	1	0	1	1	0
113	0	0	0	0	1	1	1	0
114	1	0	0	0	1	1	1	0
115	0	1	0	0	1	1	1	0
116	1	1	0	0	1	1	1	0
117	0	0	1	0	1	1	1	0
118	1	0	1	0	1	1	1	0
119	0	1	1	0	1	1	1	0
120	1	1	1	0	1	1	1	0
121	0	0	0	1	1	1	1	0
122	1	0	0	1	1	1	1	0
123	0	1	0	1	1	1	1	0
124	1	1	0	1	1	1	1	0

(Continued on next page)



Address	DIP Switch							
	1	2	3	4	5	6	7	8
125	0	0	1	1	1	1	1	0
126	1	0	1	1	1	1	1	0
127	0	1	1	1	1	1	1	0
128	1	1	1	1	1	1	1	0
129	0	0	0	0	0	0	0	1
130	1	0	0	0	0	0	0	1
131	0	1	0	0	0	0	0	1
132	1	1	0	0	0	0	0	1
133	0	0	1	0	0	0	0	1
134	1	0	1	0	0	0	0	1
135	0	1	1	0	0	0	0	1
136	1	1	1	0	0	0	0	1
137	0	0	0	1	0	0	0	1
138	1	0	0	1	0	0	0	1
139	0	1	0	1	0	0	0	1
140	1	1	0	1	0	0	0	1
141	0	0	1	1	0	0	0	1
142	1	0	1	1	0	0	0	1
143	0	1	1	1	0	0	0	1
144	1	1	1	1	0	0	0	1
145	0	0	0	0	1	0	0	1
146	1	0	0	0	1	0	0	1
147	0	1	0	0	1	0	0	1
148	1	1	0	0	1	0	0	1
149	0	0	1	0	1	0	0	1
150	1	0	1	0	1	0	0	1
151	0	1	1	0	1	0	0	1
152	1	1	1	0	1	0	0	1
153	0	0	0	1	1	0	0	1
154	1	0	0	1	1	0	0	1
155	0	1	0	1	1	0	0	1
156	1	1	0	1	1	0	0	1
157	0	0	1	1	1	0	0	1
158	1	0	1	1	1	0	0	1
159	0	1	1	1	1	0	0	1
160	1	1	1	1	1	0	0	1
161	0	0	0	0	0	1	0	1
162	1	0	0	0	0	1	0	1
163	0	1	0	0	0	1	0	1
164	1	1	0	0	0	1	0	1
165	0	0	1	0	0	1	0	1
166	1	0	1	0	0	1	0	1
167	0	1	1	0	0	1	0	1
168	1	1	1	0	0	1	0	1
169	0	0	0	1	0	1	0	1
170	1	0	0	1	0	1	0	1
171	0	1	0	1	0	1	0	1
172	1	1	0	1	0	1	0	1
173	0	0	1	1	0	1	0	1
174	1	0	1	1	0	1	0	1
175	0	1	1	1	0	1	0	1
176	1	1	1	1	0	1	0	1
177	0	0	0	0	1	1	0	1
178	1	0	0	0	1	1	0	1
179	0	1	0	0	1	1	0	1
180	1	1	0	0	1	1	0	1
181	0	0	1	0	1	1	0	1
182	1	0	1	0	1	1	0	1
183	0	1	1	0	1	1	0	1
184	1	1	1	0	1	1	0	1
185	0	0	0	1	1	1	0	1
186	1	0	0	1	1	1	0	1
187	0	1	0	1	1	1	0	1
188	1	1	0	1	1	1	0	1
189	0	0	1	1	1	1	0	1

Address	DIP Switch							
	1	2	3	4	5	6	7	8
190	1	0	1	1	1	1	0	1
191	0	1	1	1	1	1	0	1
192	1	1	1	1	1	1	0	1
193	0	0	0	0	0	0	1	1
194	1	0	0	0	0	0	1	1
195	0	1	0	0	0	0	1	1
196	1	1	0	0	0	0	1	1
197	0	0	1	0	0	0	1	1
198	1	0	1	0	0	0	1	1
199	0	1	1	0	0	0	1	1
200	1	1	1	0	0	0	1	1
201	0	0	0	1	0	0	1	1
202	1	0	0	1	0	0	1	1
203	0	1	0	1	0	0	1	1
204	1	1	0	1	0	0	1	1
205	0	0	1	1	0	0	1	1
206	1	0	1	1	0	0	1	1
207	0	1	1	1	0	0	1	1
208	1	1	1	1	0	0	1	1
209	0	0	0	0	1	0	1	1
210	1	0	0	0	1	0	1	1
211	0	1	0	0	1	0	1	1
212	1	1	0	0	1	0	1	1
213	0	0	1	0	1	0	1	1
214	1	0	1	0	1	0	1	1
215	0	1	1	0	1	0	1	1
216	1	1	1	0	1	0	1	1
217	0	0	0	1	1	0	1	1
218	1	0	0	1	1	0	1	1
219	0	1	0	1	1	0	1	1
220	1	1	0	1	1	0	1	1
221	0	0	1	1	1	0	1	1
222	1	0	1	1	1	0	1	1
223	0	1	1	1	1	0	1	1
224	1	1	1	1	1	0	1	1
225	0	0	0	0	0	1	1	1
226	1	0	0	0	0	1	1	1
227	0	1	0	0	0	1	1	1
228	1	1	0	0	0	1	1	1
229	0	0	1	0	0	1	1	1
230	1	0	1	0	0	1	1	1
231	0	1	1	0	0	1	1	1
232	1	1	1	0	0	1	1	1
233	0	0	0	1	0	1	1	1
234	1	0	0	1	0	1	1	1
235	0	1	0	1	0	1	1	1
236	1	1	0	1	0	1	1	1
237	0	0	1	1	0	1	1	1
238	1	0	1	1	0	1	1	1
239	0	1	1	1	0	1	1	1
240	1	1	1	1	0	1	1	1
241	0	0	0	0	1	1	1	1
242	1	0	0	0	1	1	1	1
243	0	1	0	0	1	1	1	1
244	1	1	0	0	1	1	1	1
245	0	0	1	0	1	1	1	1
246	1	0	1	0	1	1	1	1
247	0	1	1	0	1	1	1	1
248	1	1	1	0	1	1	1	1
249	0	0	0	1	1	1	1	1
250	1	0	0	1	1	1	1	1
251	0	1	0	1	1	1	1	1
252	1	1	0	1	1	1	1	1
253	0	0	1	1	1	1	1	1

0 = OFF  
1 = ON

# SPECIFICATIONS

## **ELECTRICAL**

Input Voltage:	100-240 VAC, 50/60 Hz, auto-ranging
Power:	30 VA
Data Ports	
Diagnostic:	RS-232, DB9 connector
Input:	RS-485, RJ-45 connector
Output:	RS-485, RJ-45 connector
Indicators:	Two green power LEDs One red alarm LED
Fusing:	500 mA, 250V
Relay Output:	Load rating for relay contacts: 0.50A at 125 VAC or 1A at 25 VAC

## **GENERAL**

Dimensions:	See Figure 16.
Operating Temperature:	32° to 122°F (0° to 50°C)
Unit Weight:	7 lb (3.17 kg)

## **MECHANICAL**

Connectors	
Alarms:	Four dual-header, 32-input connectors with mating plugs
Power:	3-wire receptacle, #18 AWG
RS-485:	Two RJ-45 connectors
RS-232:	One DB9 connector (factory use only)
Relay Output:	One 3-pin header with mating plug

*(Design and product specifications subject to change without notice.)*

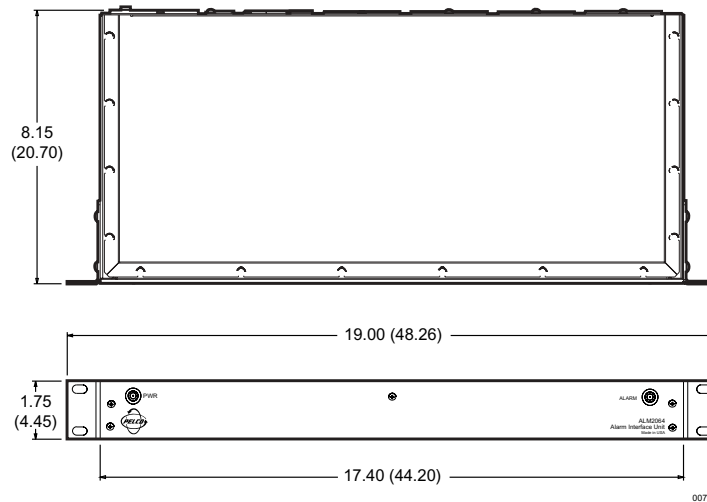

**Figure 16.** ALM2064 Dimension Diagram

## REGULATORY NOTICES

This equipment has been tested and found to comply with the limits of a Class B digital device, pursuant to part 15 of the FCC rules. These limits are designed to provide reasonable protection against harmful interference in a residential installation. This equipment generates, uses, and can radiate radio frequency energy and, if not installed and used in accordance with the instructions, may cause harmful interference to radio communications. However there is no guarantee that the interference will not occur in a particular installation. If this equipment does cause harmful interference to radio or television reception, which can be determined by turning the equipment off and on, the user is encouraged to try and correct the interference by one or more of the following measures:

- Reorient or relocate the receiving antenna.
- Increase the separation between the equipment and the receiver.
- Connect the equipment into an outlet on a circuit different from that to which the receiver is connected.
- Consult the dealer or an experienced radio/TV technician for help.

### WARRANTY AND RETURN INFORMATION

#### WARRANTY

Pelco will repair or replace, without charge, any merchandise proved defective in material or workmanship for a period of one year after the date of shipment. Exceptions to this warranty are as noted below:

- Five years on Pelco manufactured cameras (CC3500/CC3600/CC3700 and MC3500/MC3600 Series); two years on all other cameras.
- Three years on Genex® Series (multiplexers, server, and keyboard) and 090 Series Camclosure® Camera System.
- Two years on 100/150, 200, and 300 Series Camclosure Camera Systems.
- Two years on all standard motorized or fixed focal length lenses.
- Two years on Legacy®, CM6700/CM6800/CM8500/CM9500/CM9740/CM9760 Matrix, DF5 and DF8 Series Fixed Dome products.
- Two years on Spectra®, Esprit®, and PS20 Scanners, including when used in continuous motion applications.
- Two years on Esprit and WW5700 series window wiper (excluding wiper blades).
- Eighteen months on DX Series digital video recorders.
- One year (except video heads) on video cassette recorders (VCRs). Video heads will be covered for a period of six months.
- Six months on all pan and tilts, scanners or preset lenses used in continuous motion applications (that is, preset scan, tour and auto scan modes).

Pelco will warrant all replacement parts and repairs for 90 days from the date of Pelco shipment. All goods requiring warranty repair shall be sent freight prepaid to Pelco, Clovis, California. Repairs made necessary by reason of misuse, alteration, normal wear, or accident are not covered under this warranty.

Pelco assumes no risk and shall be subject to no liability for damages or loss resulting from the specific use or application made of the Products. Pelco's liability for any claim, whether based on breach of contract, negligence, infringement of any rights of any party or product liability, relating to the Products shall not exceed the price paid by the Dealer to Pelco for such Products. In no event will Pelco be liable for any special, incidental or consequential damages (including loss of use, loss of profit and claims of third parties) however caused, whether by the negligence of Pelco or otherwise.

The above warranty provides the Dealer with specific legal rights. The Dealer may also have additional rights, which are subject to variation from state to state.

If a warranty repair is required, the Dealer must contact Pelco at (800) 289-9100 or (559) 292-1981 to obtain a Repair Authorization number (RA), and provide the following information:

1. Model and serial number
2. Date of shipment, P.O. number, Sales Order number, or Pelco invoice number
3. Details of the defect or problem

If there is a dispute regarding the warranty of a product which does not fall under the warranty conditions stated above, please include a written explanation with the product when returned.

Method of return shipment shall be the same or equal to the method by which the item was received by Pelco.

#### RETURNS

In order to expedite parts returned to the factory for repair or credit, please call the factory at (800) 289-9100 or (559) 292-1981 to obtain an authorization number (CA number if returned for credit, and RA number if returned for repair).

All merchandise returned for credit may be subject to a 20% restocking and refurbishing charge.

Goods returned for repair or credit should be clearly identified with the assigned CA or RA number and freight should be prepaid. Ship to the appropriate address below.

*If you are located within the continental U.S., Alaska, Hawaii or Puerto Rico:*

Service Department  
Pelco  
3500 Pelco Way  
Clovis, CA 93612-5699

*If you are located outside the continental U.S., Alaska, Hawaii or Puerto Rico:*

**Intermediate Consignee**  
American Overseas Air Freight  
320 Beach Road  
Burlingame, CA 94010  
USA

**Ultimate Consignee**  
Pelco  
3500 Pelco Way  
Clovis, CA 93612-5699  
USA

#### REVISION HISTORY

Manual #	Date	Comments
C1517M	5/01	Original version.
C1517M-A	11/02	Updated manual to new format. Revised Table A and updated Table B.



World Headquarters  
3500 Pelco Way  
Clovis, California 93612 USA

USA & Canada  
Tel: 800/289-9100  
Fax: 800/289-9150

International  
Tel: 1-559/292-1981  
Fax: 1-559/348-1120

**[www.pelco.com](http://www.pelco.com)**

**ISO9001**

Orangeburg, New York | Las Vegas, Nevada | Eindhoven, The Netherlands | Wokingham, United Kingdom | Montreal, Canada

## Free Manuals Download Website

<http://myh66.com>

<http://usermanuals.us>

<http://www.somanuals.com>

<http://www.4manuals.cc>

<http://www.manual-lib.com>

<http://www.404manual.com>

<http://www.luxmanual.com>

<http://aubethermostatmanual.com>

Golf course search by state

<http://golfingnear.com>

Email search by domain

<http://emailbydomain.com>

Auto manuals search

<http://auto.somanuals.com>

TV manuals search

<http://tv.somanuals.com>