

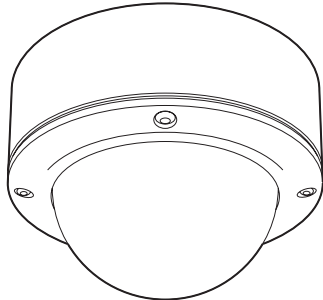

Installation/Operation

100 Series Camclosure® Integrated Camera System

C2407M-G (5/03)



Pelco • 3500 Pelco Way • Clovis, CA 93612-5699 USA • www.pelco.com
In North America and Canada: Tel (800) 289-9100 • FAX (800) 289-9150
International Customers: Tel +1(559) 292-1981 • FAX +1(559) 348-1120

CONTENTS

<u>Section</u>	<u>Page</u>
IMPORTANT SAFEGUARDS AND WARNINGS	4
DESCRIPTION	4
INSTALLATION	4
INSTALL BASE	4
MOUNTING DIRECTLY TO WALL OR CEILING	4
MOUNTING DIRECTLY TO CONCRETE WALL OR CEILING	5
MOUNTING TO A 4S ELECTRICAL BOX	5
MOUNTING TO A PLASTER RING	5
CONNECT VIDEO AND POWER	5
INSTALL CAMERA	6
INSTALL DOME AND TRIM RING	7
ADJUSTMENTS (COLOR CAMERA ONLY)	7
VERTICAL PHASE (24 VAC OPERATION ONLY)	7
AUTO IRIS LEVEL ADJUSTMENT	8
FOCUS ADJUSTMENT FOR FIXED FOCAL LENGTH LENS WITH AUTO IRIS	8
SWITCH SETTINGS FOR FIXED FOCAL LENGTH LENS WITH AUTO IRIS	9
SWITCH SETTINGS FOR FIXED FOCAL LENGTH LENS WITHOUT AUTO IRIS	9
SWITCH SETTINGS FOR VARIFOCAL LENS	10
SPECIFICATIONS	10
REGULATORY NOTICES	11
WARRANTY AND RETURN INFORMATION	12

IMPORTANT SAFEGUARDS AND WARNINGS

1. Installation and servicing should be done only by qualified service personnel and conform to all local codes.
2. Unless the unit is specifically marked as a NEMA Type 3, 3R, 3S, 4, 4X, 6 or 6P enclosure, it is designed for indoor use only and must not be installed where exposed to rain and moisture.
3. Use only installation methods and materials capable of supporting four times the maximum specified load.
4. Use stainless steel hardware to fasten the enclosure to outdoor surfaces.
5. To prevent damage from water leakage when installing an enclosure outdoors, apply sealant around the bolt holes between the enclosure and mounting surface.

DESCRIPTION

The 100 Series Camclosure® Integrated Camera System is a surface-mount dome incorporating a camera and lens package into a small, discreet, high-security enclosure designed for indoor/outdoor areas that are subject to heavy vandalism.

INSTALLATION

① Install Base

Mounting Directly to Wall or Ceiling

1. Cut a small hole in the ceiling or wall for power and video wiring. Use the adapter plate as a template.
2. Pull video and power wires into the base, and attach the base to the wall or ceiling (hardware not supplied). The electrical opening in the base will accept a 3/4-inch (1.91 cm) conduit fitting.

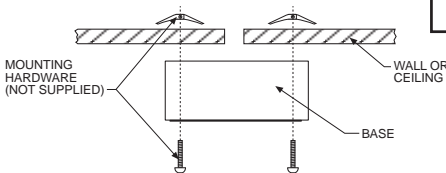

IMPORTANT

To maximize tamper resistance when not using the side conduit opening for wire connections, verify that the conduit plug and set screw are tight.

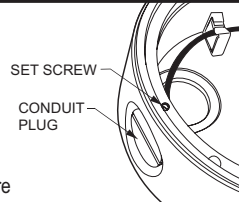

Mounting Directly to Concrete Wall or Ceiling

1. Attach the base to the wall or ceiling (hardware not supplied).
2. Do one of the following:
 - a. Not Using Side Conduit Opening - Verify the set screw and side conduit cover are tight.
OR
 - b. Using Conduit to Side Opening - Loosen the set screw and remove the conduit plug.
3. Install a 3/4-inch (1.91 cm) conduit fitting and tighten the set screw.
4. Pull video and power wires into the base.

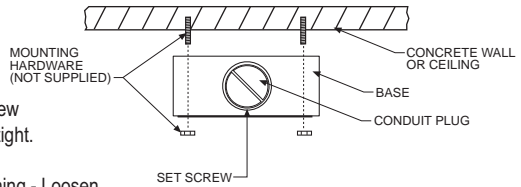

Mounting to a 4S Electrical Box

1. Attach the ICS100-AP adapter plate (not supplied) to the 4S box with the two 8-32 x .750-inch flat head screws.
2. Pull video and power wires into the base, and attach the base to the adapter plate with the three 8-32 x .375-inch pan head screws.

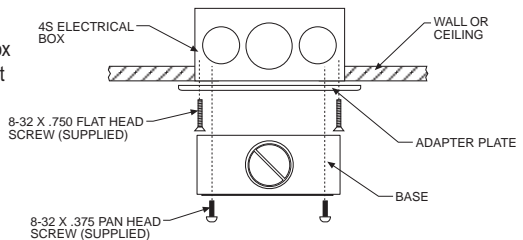

Mounting to a Plaster Ring

Pull video and power wires into the base, and attach the base to the plaster ring.

- Use the two 8-32 x .750-inch pan head screws to attach the base to a 401 plaster ring.
- Use the three 6-32 x .750-inch pan head screws to attach the base to a 404 plaster ring.

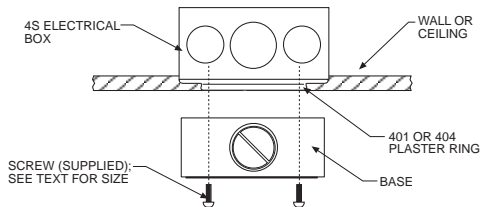

2 Connect Video and Power

1. Connect the video cable.
2. Depending on the input voltage, connect either the 12 VDC or 24 VAC input power wires to the appropriate positions on the terminal block inside the base.
3. **12 VDC Operation Only** – The camera is set for 24 VAC operation at the factory. For 12 VDC operation remove the jumper from the 24 VAC position and install it on the 12 VDC position.

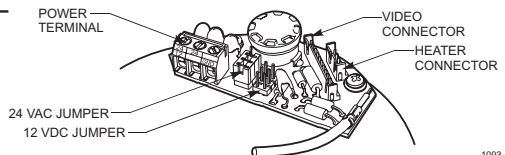

1093

CAUTION



Heater elements could be hot! When camera power is on, use caution when adjusting the camera. This applies to all models.

3 Install Camera

1. Some indoor installations do not require a heater. If the installation does not require a heater, remove the heater board from the camera assembly. To remove the heater apply pressure and press on the corner of the board.

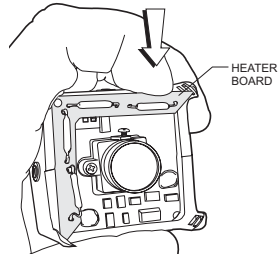

2. If the heater is installed, plug the heater connector from the camera into the mating connector inside the base. Plug the video connector from the camera into the mating connector inside the base.

Turn on power to the camera and monitor.

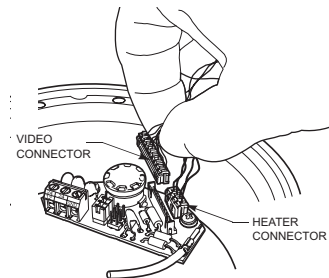

3. If you have a varifocal lens, hold the assembly in your hand and point the lens toward what you want to view. Loosen the focal length and focus locking screws. Adjust according to scene detail. Retighten the screws.

VARIFOCAL LENS

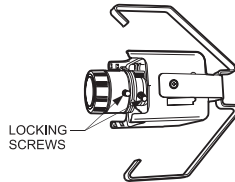

4. Always make sure the tab on the camera bracket is pointing out of the enclosure (away from the ceiling or wall). Gently squeeze the bracket, place it against the shoulder inside the base, and gently release.

Proper camera orientation:

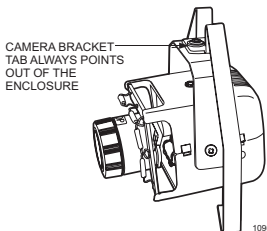

Wall Mounting – The camera bracket tab points out of the enclosure and the top of the camera points up towards the tab.

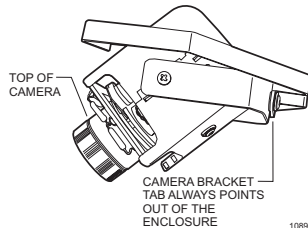

Ceiling Mounting – The camera bracket tab points out of the enclosure and the top of the camera is pointed in the opposite direction.

4 Install Dome and Trim Ring

1. Align the screw holes in the trim ring with those in the camclosure base.
2. **Domes with Liners (only)** – Position the viewing window over the lens of the camera.
 - a. Loosen the three Phillip screws located in the dome.
 - b. Insert the blade of a standard screwdriver in one of the adjustment grooves. Move dome into position.
 - c. Tighten the three Phillip screws to lock liner in place.
3. Tighten the tamper-resistant screws with the supplied 1/8-inch hollow screwdriver bit.

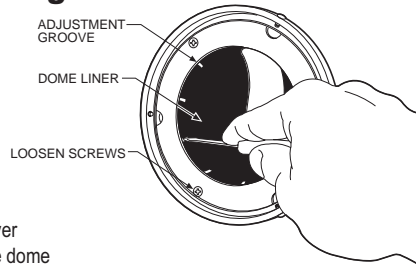

ADJUSTMENTS (COLOR CAMERA ONLY)

If you have a color camera, it is set up at the factory and normally requires no adjustments. Sometimes, however, adjustments may be necessary.

1. Remove the dome and trim ring using the supplied 1/8-inch hollow screwdriver bit.
2. Adjust the vertical phase, iris level, focus, or switch settings (refer to procedures below).
3. Replace the dome and trim ring.

Vertical Phase (24 VAC Operation Only)

Adjustment is required if there is vertical roll when switching between two cameras.

1. Reverse the 24 VAC connections on one camera. If both cameras are connected to the same transformer, this should solve the problem.
2. If reversing the connections does not solve the problem, or if cameras are connected to different transformers, turn the adjustment screw on one camera (while switching as rapidly as possible between the two camera views) until the switching is clean and there is no vertical roll. If more than two cameras are out of synchronization with each other, choose one camera and synchronize all others to it.

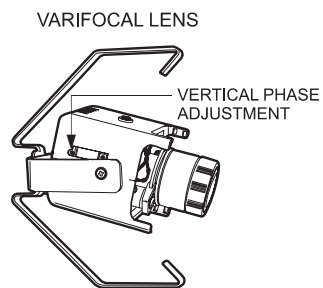
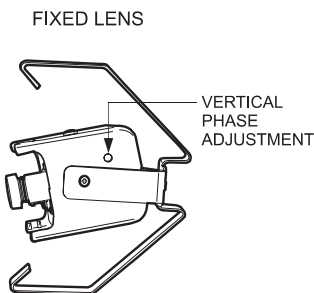

Auto Iris Level Adjustment

If you have a varifocal lens or fixed focal length lens with an auto iris, you can adjust the level setting to increase or decrease brightness.

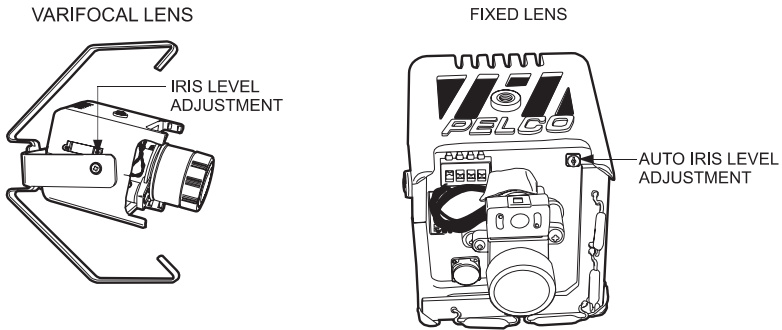

Focus Adjustment for Fixed Focal Length Lens with Auto Iris

CAUTION



Heater elements could be hot! When camera power is on, use caution when adjusting the camera.

To adjust the focus, it may be necessary to remove the heater board in order to loosen the locking screw on the bottom of the lens.

To remove the heater board:

1. Disconnect the four-pin heater wiring.
2. Wait for the heater elements to cool if they are hot.
3. Apply pressure and press on the corner of the board.

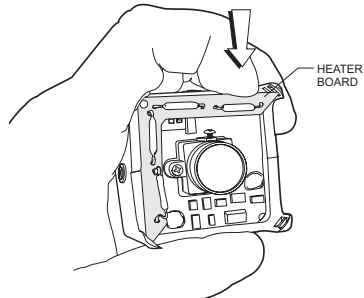

To adjust the focus:

1. Loosen the locking screw on the bottom of the lens.
2. Move the screw in the slot to bring the picture into focus.
3. Retighten the locking screw.
4. Replace the heater board if it was removed.
5. Reconnect the four-pin heater wiring.

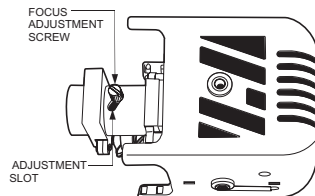

BOTTOM VIEW OF CAMERA WITH HEATER BOARD REMOVED

Switch Settings for Fixed Focal Length Lens with Auto Iris

Refer to the switch drawing. The switch is located next to the lens. Automatic backlight compensation (factory setting) is used under varying lighting conditions (such as outdoors) or fixed lighting conditions where there are no bright spots that darken other picture details. Manual backlight compensation is used in fixed lighting conditions to optimize the picture detail when there are bright spots.

ALC/ELC switch:	Always ALC
Y/DC switch:	Always DC
Auto backlight compensation:	BLC switch OFF ABL switch ON
Manual backlight compensation:	BLC switch ON ABL switch OFF

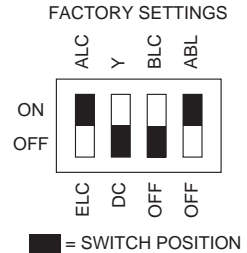

Switch Settings for Fixed Focal Length Lens Without Auto Iris

Refer to the switch drawing. The switch is located next to the lens. Automatic backlight compensation (factory setting) is used under varying lighting conditions (such as outdoors) or fixed lighting conditions where there are no bright spots that darken other picture details. Manual backlight compensation is used in fixed lighting conditions to optimize the picture detail when there are bright spots.

ALC/ELC switch:	Always ELC
Y/DC switch:	Not used
Auto backlight compensation:	BLC switch OFF ABL switch ON
Manual backlight compensation:	BLC switch ON ABL switch OFF

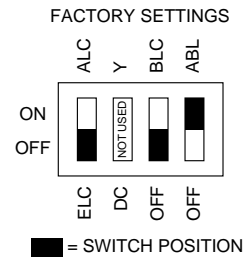

Switch Settings for Varifocal Lens

The high resolution camera with varifocal lens and auto iris is configured at the factory for optimal performance in lighting conditions where auto iris is required. It is also configured with the shutter speed set at 1/60 (NTSC) or 1/50 (PAL) and AGC set at 6 dB of gain.

- | | | | | |
|--------------|---|---|----------|----------------------------|
| AE Functions | [| 1 | AWB | Automatic white balance |
| | | 2 | GAM | Gamma function |
| | | 3 | AGC | Automatic gain control |
| | | 4 | ESC | Electronic shutter control |
| | | 5 | BLC | Backlight compensation |
| | | 6 | FL | Flickerless |
| | | 7 | AE | Automatic exposure |
| | | 8 | Not used | |

FACTORY SETTINGS

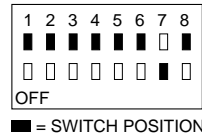

To enable automatic exposure

Turn on switch 7, and then turn on/off switch 4 for electronic shutter control, switch 5 for backlight compensation, and switch 6 for flickerless motion.

To manually set and lock AWB

Place a white background in front of camera and turn off switch 1.

For gamma correction

Switch to accurately reproduce scene brightness; when turned on, $y = 0.6$, and when turned off, $y = 1.0$.

For gain control

Switch 3 On increases gain by 6 dB, and switch 3 Off increases gain by 18 dB.

To enable auto iris and manually set shutter speed

Turn off switch 7; set switches 4, 5, and 6 for the desired shutter speed.

CAUTION Do not change the shutter speed unless you understand how changing the settings will affect the scene detail.

Shutter Speed	Switch Number and Position			
	7	6	5	4
1/60 (NTSC)	Off	On	On	On
1/50 (PAL)		Off	On	On
1/100		On	Off	On
1/250		Off	Off	On
1/500		On	On	Off
1/1000		Off	On	Off
1/2000		On	Off	Off
1/4000		Off	Off	Off
1/10000		Off	Off	Off

SPECIFICATIONS

General

- Operating Temperature: -50° to 122°F (-46° to 50°C)
De-ices to 25°F (-4°C)
- Cable Entry: 3/4-inch (1.91 cm) conduit fitting and 3/4-inch (1.91 cm) opening for NPT threaded pipe
- Pan/Tilt Adjustment: Manual; 360° pan; 180° tilt
- Construction: Aluminum with steel camera mounting bracket and polycarbonate dome
- Finish: Gray polyester powder coat
- Dimensions
Base: 3.70 (H) x 5.30 (W) inches (9.40 x 13.50 cm)
Bubble: 3.75-inch diameter
- Environment: Low temperature, indoor/outdoor
- Unit Weight: 2.20 lb (1.00 kg)

Electrical

- Input Voltage: 12 VDC or 24 VAC, ±10%
- Power Consumption: 13 watts or less
- Video Connector: BNC

Certifications

- NTSC and EIA Models: UL and cUL
- NTSC and PAL Color Models: FCC, Class B (excluding auto iris models)
- EIA and CCIR Monochrome Models: FCC, Class A (excluding auto iris models)
- PAL and CCIR Models: CE Class B, UL and cUL

(Design and product specifications subject to change without notice.)

Regulatory Notices

FCC Class A (monochrome, EIA and CCIR cameras – except auto iris models)

This equipment has been tested and found to comply with the limits of a Class A digital device, pursuant to part 15 of the FCC rules. These limits are designed to provide reasonable protection against harmful interference when the equipment is operated in a commercial environment. This equipment generates, uses, and can radiate radio frequency energy and, if not installed and used in accordance with the instruction manual, may cause harmful interference to radio communications. Operation of this equipment in a residential area is likely to cause harmful interference in which case the user will be required to correct the interference at his own expense.

FCC Class B (color, NTSC and PAL cameras – except auto iris models)

This equipment has been tested and found to comply with the limits of a Class B digital device, pursuant to part 15 of the FCC rules. These limits are designed to provide reasonable protection against harmful interference in a residential installation. This equipment generates, uses, and can radiate radio frequency energy and, if not installed and used in accordance with the instructions, may cause harmful interference to radio communications. However there is no guarantee that the interference will not occur in a particular installation. If this equipment does cause harmful interference to radio or television reception, which can be determined by turning the equipment off and on, the user is encouraged to try and correct the interference by one or more of the following measures:

- Reorient or relocate the receiving antenna.
- Increase the separation between the equipment and the receiver.
- Connect the equipment into an outlet on a circuit different from that to which the receiver is connected.
- Consult the dealer or an experienced radio/TV technician for help.

REVISION HISTORY

Manual #	Date	Comments
C2407M	11/99	Original version.
C2407M	1/00	Revised installation instructions. Added FCC notices.
C2407M-A	1/00	Added varifocal lens. Changed format.
C2407M-B	7/00	Added information on dome liner.
C2407M-C	1/01	Added information on conduit set screw and heater element caution.
C2407M-D	7/01	Camera module redesigned, reference ECO 01-7054/7055/7056.
C2407M-E	12/01	Manual revised to reflect product design revision.
C2407M-F	7/02	Added instructions for fixed lens with auto iris.
C2407M-G	5/03	Revised installation instructions – bracket and camera assembled at factory. Added iris level adjustment for fixed lens with auto iris.

PRODUCT WARRANTY AND RETURN INFORMATION

WARRANTY

Pelco will repair or replace, without charge, any merchandise proved defective in material or workmanship for a period of one year after the date of shipment.

Exceptions to this warranty are as noted below:

- Five years on FT/FR8000 Series fiber optic products.
- Three years on Genex® Series products (multiplexers, server, and keyboard).
- Three years on Camclosure® and fixed camera models, except the CC3701H-2, CC3701H-2X, CC3751H-2, CC3651H-2X, MC3651H-2, and MC3651H-2X camera models, which have a five-year warranty.
- Two years on standard motorized or fixed focal length lenses.
- Two years on Legacy®, CM6700/CM6800/CM9700 Series matrix, and DF5/DF8 Series fixed dome products.
- Two years on Spectra®, Esprit®, ExSite™, and PS20 scanners, including when used in continuous motion applications.
- Two years on Esprit® and WWW5700 Series window wiper (excluding wiper blades).
- Eighteen months on DX Series digital video recorders, NVR300 Series network video recorders, and Endura™ Series distributed network-based video products.
- One year (except video heads) on video cassette recorders (VCRs). Video heads will be covered for a period of six months.
- Six months on all pan and tilts, scanners or preset lenses used in continuous motion applications (that is, preset scan, tour and auto scan modes).

Pelco will warrant all replacement parts and repairs for 90 days from the date of Pelco shipment. All goods requiring warranty repair shall be sent freight prepaid to Pelco, Clovis, California. Repairs made necessary by reason of misuse, alteration, normal wear, or accident are not covered under this warranty.

Pelco assumes no risk and shall be subject to no liability for damages or loss resulting from the specific use or application made of the Products. Pelco's liability for any claim, whether based on breach of contract, negligence, infringement of any rights or product liability, relating to the Products shall not exceed the price paid by the Dealer to Pelco for such Products. In no event will Pelco be liable for any special, incidental or consequential damages (including loss of use, loss of profit and claims of third parties) however caused, whether by the negligence of Pelco or otherwise.

The above warranty provides the Dealer with specific legal rights. The Dealer may also have additional rights, which are subject to variation from state to state.

If a warranty repair is required, the Dealer must contact Pelco at (800) 289-9100 or (559) 292-1981 to obtain a Repair Authorization number (RA), and provide the following information:

1. Model and serial number
2. Date of shipment, P.O. number, Sales Order number, or Pelco invoice number
3. Details of the defect or problem

If there is a dispute regarding the warranty of a product which does not fall under the warranty conditions stated above, please include a written explanation with the product when returned.

Method of return shipment shall be the same or equal to the method by which the item was received by Pelco.

RETURNS

In order to expedite parts returned to the factory for repair or credit, please call the factory at (800) 289-9100 or (559) 292-1981 to obtain an authorization number (CA number if returned for credit, and RA number if returned for repair).

All merchandise returned for credit may be subject to a 20% restocking and refurbishing charge.

Goods returned for repair or credit should be clearly identified with the assigned CA or RA number and freight should be prepaid. Ship to the appropriate address below.

If you are located within the continental U.S., Alaska, Hawaii or Puerto Rico, send goods to:

Service Department
Pelco
3500 Pelco Way
Clovis, CA 93612-5699

If you are located outside the continental U.S., Alaska, Hawaii or Puerto Rico and are instructed to return goods to the USA, you may do one of the following:

If the goods are to be sent by a COURIER SERVICE, send the goods to:

Pelco
3500 Pelco Way
Clovis, CA 93612-5699 USA

If the goods are to be sent by a FREIGHT FORWARDER, send the goods to:

Pelco c/o Expeditors
473 Eccles Avenue
South San Francisco, CA 94080 USA
Phone: 650-737-1700
Fax: 650-737-0933

Pelco, the Pelco logo, Spectra, Genex, Legacy, Esprit, and Camclosure are registered trademarks of Pelco.

Endura and ExSite are trademarks of Pelco.

© Copyright 2003, Pelco. All rights reserved.

Free Manuals Download Website

<http://myh66.com>

<http://usermanuals.us>

<http://www.somanuals.com>

<http://www.4manuals.cc>

<http://www.manual-lib.com>

<http://www.404manual.com>

<http://www.luxmanual.com>

<http://aubethermostatmanual.com>

Golf course search by state

<http://golfingnear.com>

Email search by domain

<http://emailbydomain.com>

Auto manuals search

<http://auto.somanuals.com>

TV manuals search

<http://tv.somanuals.com>