

# INSTALLATION



## 110 Series Camclosure® Integrated Camera System



**Surface Mount**

**C2403M-E (2/08)**



# Contents

---

Important Safety Instructions . . . . .	4
Regulatory Notices . . . . .	5
Description . . . . .	6
Installation . . . . .	7
Mounting Directly to Surface . . . . .	7
Wiring Through Base . . . . .	7
Wiring Through Side Conduit . . . . .	8
Mounting to a 4S Electrical Box . . . . .	8
Mounting to a Plaster Ring . . . . .	8
Install Camera . . . . .	9
Install Dome and Trim Ring . . . . .	10
Adjustments . . . . .	11
Vertical Phase (24 VAC Operation Only) . . . . .	11
Focus Adjustment for Fixed Focal Length Lens with Auto Iris . . . . .	12
Switch Settings for Fixed Focal Length Lens Without Auto Iris . . . . .	12
Specifications . . . . .	13

# Important Safety Instructions

---

1. Read these instructions.
2. Keep these instructions.
3. Heed all warnings.
4. Follow all instructions.
5. Do not block any ventilation openings. Install in accordance with the manufacturer's instructions.
6. Do not install near any heat sources such as radiators, heat registers, stoves, or other apparatus (including amplifiers) that produce heat.
7. Only use attachments/accessories specified by the manufacturer.
8. Use only with the cart, stand, tripod, bracket, or table specified by the manufacturer, or sold with the apparatus. When a cart is used, use caution when moving the cart/apparatus combination to avoid injury from tip-over.
9. Refer all servicing to qualified service personnel. Servicing is required when the apparatus has been damaged in any way, such as power-supply cord or plug is damaged, liquid has been spilled or objects have fallen into the apparatus, the apparatus has been exposed to rain or moisture, does not operate normally, or has been dropped.
10. Installation should be done only by qualified personnel and conform to all local codes.
11. Unless the unit is specifically marked as a NEMA Type 3, 3R, 3S, 4, 4X, 6, or 6P enclosure, it is designed for indoor use only and it must not be installed where exposed to rain and moisture.
12. Use only installation methods and materials capable of supporting four times the maximum specified load.
13. Use stainless steel hardware to fasten the mount to outdoor surfaces.
14. To prevent damage from water leakage when installing a mount outdoors on a roof or wall, apply sealant around the bolt holes between the mount and mounting surface.
15. **CAUTION:** These servicing instructions are for use by qualified service personnel only. To reduce the risk of electric shock do not perform any servicing other than that contained in the operating instructions unless you are qualified to do so.
16. Only use replacement parts recommended by Pelco.

The product and/or manual may bear the following marks:



This symbol indicates that dangerous voltage constituting a risk of electric shock is present within this unit.



This symbol indicates that there are important operating and maintenance instructions in the literature accompanying this unit.

<b>CAUTION:</b>
<b>RISK OF ELECTRIC SHOCK. DO NOT OPEN.</b>

Please thoroughly familiarize yourself with the information in this manual prior to installation and operation.

# Regulatory Notices

---

This device complies with Part 15 of the FCC Rules. Operation is subject to the following two conditions: (1) this device may not cause harmful interference, and (2) this device must accept any interference received, including interference that may cause undesired operation.

## **RADIO AND TELEVISION INTERFERENCE**

This equipment has been tested and found to comply with the limits of a Class B digital device, pursuant to Part 15 of the FCC Rules. These limits are designed to provide reasonable protection against harmful interference in a residential installation. This equipment generates, uses, and can radiate radio frequency energy and, if not installed and used in accordance with the instructions, may cause harmful interference to radio communications. However there is no guarantee that the interference will not occur in a particular installation. If this equipment does cause harmful interference to radio or television reception, which can be determined by turning the equipment off and on, the user is encouraged to try to correct the interference by one or more of the following measures:

- Reorient or relocate the receiving antenna.
- Increase the separation between the equipment and the receiver.
- Connect the equipment into an outlet on a circuit different from that to which the receiver is connected.
- Consult the dealer or an experienced radio/TV technician for help.

You may also find helpful the following booklet, prepared by the FCC: "How to Identify and Resolve Radio-TV Interference Problems." This booklet is available from the U.S. Government Printing Office, Washington D.C. 20402.

Changes and Modifications not expressly approved by the manufacturer or registrant of this equipment can void your authority to operate this equipment under Federal Communications Commission's rules.

This Class B digital apparatus complies with Canadian ICES-003.

Cet appareil numérique de la classe B est conforme à la norme NMB-003 du Canada.

# Description

---

The ICS110 Series Camclosure® integrated camera system combines an environmental cover, back box, camera, lens, and lower dome into a small, high-security system that is quick and easy to install. The system is perfect for a variety of indoor and outdoor applications, and its versatile design allows for multiple mounting options.

The ICS110 Series Camclosure can be installed directly to a ceiling, wall, 4S electrical box (using the optional ICS110-AP adapter plate), or a standard plaster ring. The system has three conduit openings: two in the base, and a threaded 0.75-inch (1.91 cm) opening in the side.

# Installation

## MOUNTING DIRECTLY TO SURFACE

### WIRING THROUGH BASE

Follow the proceeding steps when feeding wire/cables through the base of the cover and back box:

1. Using the cover as a template, mark one of the large hole positions onto the mounting surface.
2. Cut out the hole in the mounting surface for power and video wiring.
3. Pull video and power wires through the hole in the cover.
4. Attach the cover to the mounting surface (hardware not supplied). Use stainless steel hardware when installing the system outdoors.
5. Connect the video cable.
6. Connect the power wires.
  - For 12 VDC, connect the 24 VAC/12 VDC (red) and GND (black) wires to input power. The blue wire is not used.
  - For 24 VAC, connect the 24 VAC/12 VDC (red) and 24 VAC (blue) wires to input power. The black wire is not used.
7. Install the back box inside the cover. Rotate and position the back box so that the conduit plug on the side of the box is located on the opposite side (180 degrees) from the notch on the side of the cover. Use the supplied 8-32 x 0.375-inch screws and washers to secure the back box to the cover.

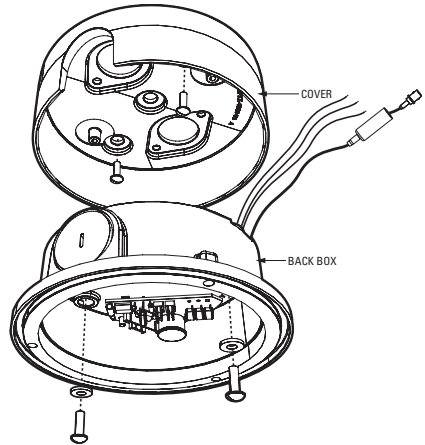

**NOTE:** For vandal-resistant installations, the conduit plug located on the side of the back box should be hidden if it is not used. To hide the conduit plug rotate the back box so that the plug is located on the opposite side (180 degrees) from the notch on the side of cover.

## WIRING THROUGH SIDE CONDUIT

Follow the proceeding steps when feeding wire/cables through the side conduit opening of the unit:

1. Attach the cover to the mounting surface (hardware not supplied). Use stainless steel hardware when installing the system outdoors.
2. Remove the conduit plug from the side of the back box.
3. Use a blunt tool to pull the wires and plug, located on the base of the back box, into the back box. Insert the black plug (supplied) into the hole in the base of the back box.
4. Install the back box inside the cover. Rotate and position the back box so that the conduit hole on the side of the back box is aligned with the side notch of the cover. Use the supplied 8-32 x 0.375-inch screws and washers to secure the back box to the cover.
5. Install a 0.75-inch (1.91 cm) conduit fitting in the conduit hole of the back box.
6. Connect the video cable.
7. Connect the power wires.
  - For 12 VDC, connect the 24 VAC/12 VDC (red) and GND (black) wires to input power. The blue wire is not used.
  - For 24 VAC, connect the 24 VAC/12 VDC (red) and 24 VAC (blue) wires to input power. The black wire is not used.

## MOUNTING TO A 4S ELECTRICAL BOX

1. Attach the ICS110-AP adapter plate (not supplied) to a 4S box with the two 8-32 x 0.75-inch flat head screws supplied with the adapter plate.
2. Pull the video and power wires into the cover, and then attach the cover to the adapter plate with the three supplied 8-32 x 0.375-inch pan head screws.
3. Connect the video cable.
4. Connect the power wires.
  - For 12 VDC, connect the 24 VAC/12 VDC (red) and GND (black) wires to input power. The blue wire is not used.
  - For 24 VAC, connect the 24 VAC/12 VDC (red) and 24 VAC (blue) wires to input power. The black wire is not used.
5. Install the back box inside the cover. For vandal-resistant installations, rotate and position the back box so that the conduit plug on the side of the box is located on the opposite side (180 degrees) from the notch on the side of the cover. Use the supplied 8-32 x 0.375-inch screws and washers to secure the back box to the cover.

## MOUNTING TO A PLASTER RING

1. Pull video and power wires into the cover, and then attach the cover to a 404 plaster ring. Use the two supplied 6-32 x 0.75-inch pan head screws to attach the cover to a 404 plaster ring.
2. Connect the video cable.
3. Connect the power wires.
  - For 12 VDC, connect the 24 VAC/12 VDC (red) and GND (black) wires to input power. The blue wire is not used.
  - For 24 VAC, connect the 24 VAC/12 VDC (red) and 24 VAC (blue) wires to input power. The black wire is not used.
4. Install the back box inside the cover. For vandal-resistant installations, rotate and position the back box so that the conduit plug on the side of the box is located on the opposite side (180 degrees) from the notch on the side of the cover. Use the supplied 8-32 x 0.375-inch screws and washers to secure the back box to the cover.



# Install Camera



**WARNING:** Heater elements could be hot! When camera power is on, use caution when adjusting the camera. This applies to all models.

1. Some indoor installations do not require a heater. If the installation does not require a heater, remove the heater board from the camera assembly. To remove the heater, press on an end of the board.

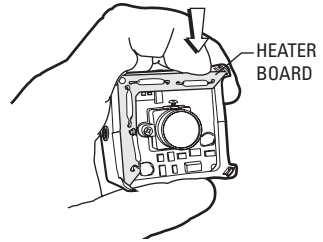

2. **12 VDC operation only:** The camera is set for 24 VAC operation at the factory. For 12 VDC operation remove the jumper from the 24 VAC position and install it in the 12 VDC position.

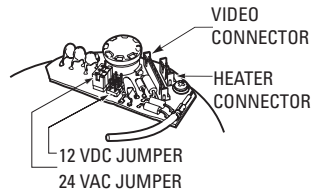

3. If the heater is installed, plug the heater connector from the camera into the mating connector inside the base. Plug the video connector from the camera into the mating connector inside the base.

Turn on power to the camera and monitor.

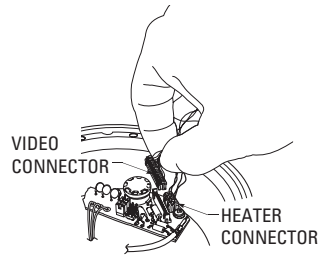

4. Always make sure the tab on the camera bracket is pointing out of the enclosure (away from the ceiling or wall). Gently squeeze the bracket, place it against the groove inside the back box, and then gently release.

Proper camera orientation:

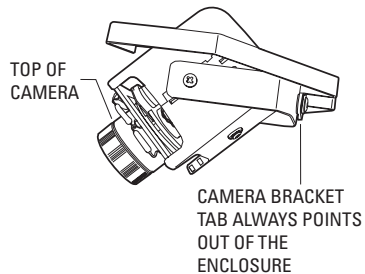
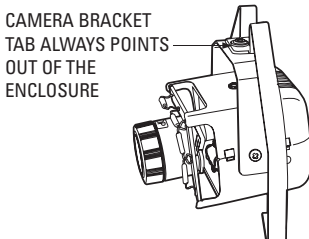

**Wall Mounting:** The camera bracket tab points out of the enclosure, and the top of the camera points up towards the tab.

**Ceiling Mounting:** The camera bracket tab points out of the enclosure, and the top of the camera is pointed in the opposite direction.

# Install Dome and Trim Ring

---

Domes with Liners (only):

1. Align the screw holes in the trim ring with those in the Camclosure base.
2. Position the viewing window over the lens of the camera.
  - a. Loosen the three Phillip screws located in the dome.
  - b. Insert the blade of a standard screwdriver in one of the adjustment grooves. Move the dome into position.
  - c. Tighten the three Phillip screws to lock the liner in place.
3. Tighten the tamper-resistant screws with the supplied 1/8-inch hollow screwdriver bit.

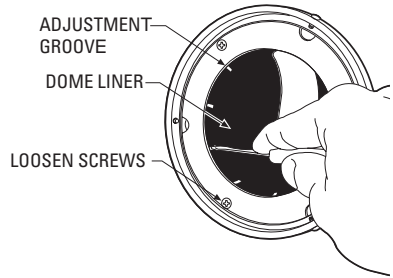

# Adjustments

---

The camera is set up at the factory and normally requires no adjustments. Sometimes, however, adjustments may be necessary.

1. Remove the dome and trim ring using the supplied 1/8-inch hollow screwdriver bit.
2. Adjust the vertical phase, focus, or switch settings (refer to the following procedures).
3. Replace the dome and trim ring.

## VERTICAL PHASE (24 VAC OPERATION ONLY)

Adjustment is required if there is vertical roll when switching between two cameras.

1. Reverse the 24 VAC connections on one camera. If both cameras are connected to the same transformer, this should solve the problem.
2. If reversing the connections does not solve the problem, or if cameras are connected to different transformers, turn the adjustment screw on one camera (while switching as rapidly as possible between the two camera views) until the switching is clean and there is no vertical roll. If more than two cameras are out of synchronization with each other, choose one camera and synchronize all others to it.

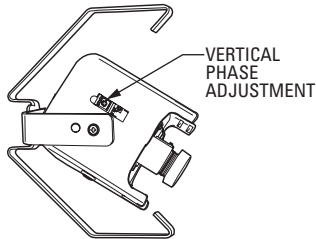

# FOCUS ADJUSTMENT FOR FIXED FOCAL LENGTH LENS WITH AUTO IRIS

**⚠ WARNING:** Heater elements could be hot! When camera power is on, use caution when adjusting the camera.

To adjust the focus, it may be necessary to remove the heater board in order to loosen the locking screw on the bottom of the lens.

To remove the heater board:

1. Disconnect the 4-pin heater wiring.
2. Wait for the heater elements to cool if they are hot.
3. Press on an end of the board.

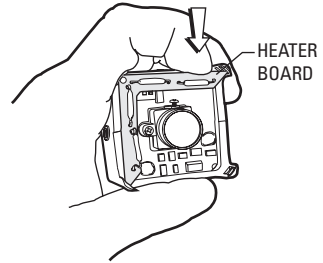

To adjust the focus:

1. Loosen the locking screw on the bottom of the lens.
2. Move the screw in the slot to bring the picture into focus.
3. Retighten the locking screw.
4. Replace the heater board if it was removed.
5. Reconnect the 4-pin heater wiring.

FOCUS  
ADJUSTMENT SCREW

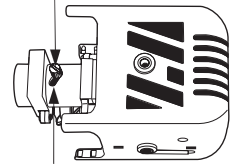

ADJUSTMENT SLOT

BOTTOM VIEW OF CAMERA  
WITH HEATER BOARD REMOVED

# SWITCH SETTINGS FOR FIXED FOCAL LENGTH LENS WITHOUT AUTO IRIS

Refer to the switch position drawing. The switch is located next to the lens. Automatic backlight compensation (factory setting) is used under varying lighting conditions (such as outdoors) or fixed lighting conditions, where there are no bright spots that darken other picture details. Manual backlight compensation is used in fixed lighting conditions to optimize the picture detail when there are bright spots.

- ALC/ELC switch: Always ELC
- Y/DC switch: Not used
- Auto backlight compensation: BLC switch OFF  
ABL switch ON
- Manual backlight compensation: BLC switch ON  
ABL switch OFF

FACTORY SETTINGS

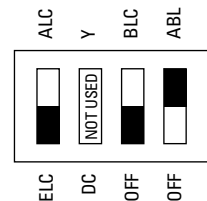

= SWITCH POSITION

# Specifications

## General

Operating Temperature	-50° to 122°F (-46° to 50°C) De-ices to 25°F (-4°C)
Cable Entry	3/4-inch (1.91 cm) conduit fitting and 3/4-inch (1.91 cm) opening for NPT threaded pipe
Pan/Tilt Adjustment	Manual; 360° pan, 180° tilt
Construction	Aluminum with steel camera mounting bracket and polycarbonate dome
Finish	Gray polyester powder coat
Environment	Low temperature, indoor/outdoor
Unit Weight	2.2 lb (1.0 kg)

## Electrical

Input Voltage	12 VDC or 24 VAC, ±10%
Power Consumption	13 W or less
Video Connector	BNC

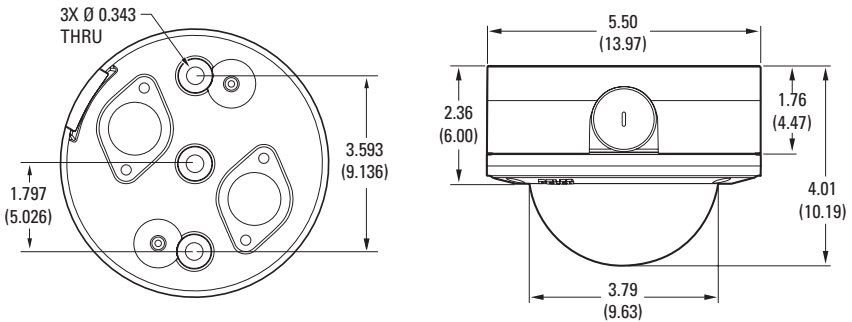

NOTE: VALUES IN PARENTHESES ARE CENTIMETERS;  
ALL OTHERS ARE INCHES.

*(Design and product specifications subject to change without notice.)*



The materials used in the manufacture of this document and its components are compliant to the requirements of Directive 2002/95/EC.



This equipment contains electrical or electronic components that must be recycled properly to comply with Directive 2002/96/EC of the European Union regarding the disposal of waste electrical and electronic equipment (WEEE). Contact your local dealer for procedures for recycling this equipment.

# PRODUCT WARRANTY AND RETURN INFORMATION

## WARRANTY

Pelco will repair or replace, without charge, any merchandise proved defective in material or workmanship **for a period of one year** after the date of shipment.

Exceptions to this warranty are as noted below:

- Five years on fiber optic products and TW3000 Series unshielded twisted pair (UTP) transmission products.
- Three years on Spectra® IV products.
- Three years on Genex® Series products (multiplexers, server, and keyboard).
- Three years on DX Series digital video recorders, DVR5100 Series digital video recorders, DigitalSENTRY® Series hardware products, DVX Series digital video recorders, NVR300 Series network video recorders, and Endura® Series distributed network-based video products.
- Three years on Camclosure® and Pelco-branded fixed camera models, except the CC3701H-2, CC3701H-2X, CC3751H-2, CC3651H-2X, MC3651H-2, and MC3651H-2X camera models, which have a five-year warranty.
- Three years on PMCL200/300/400 Series LCD monitors.
- Two years on standard motorized or fixed focal length lenses.
- Two years on Legacy®, CM6700/CM6800/CM9700 Series matrix, and DF5/DF8 Series fixed dome products.
- Two years on Spectra III™, Spectra Mini, Esprit®, ExSite®, and PS20 scanners, including when used in continuous motion applications.
- Two years on Esprit and WW5700 Series window wiper (excluding wiper blades).
- Two years (except lamp and color wheel) on Digital Light Processing (DLP®) displays. The lamp and color wheel will be covered for a period of 90 days. The air filter is not covered under warranty.
- Two years on Intelli-M® eIDC controllers.
- One year (except video heads) on video cassette recorders (VCRs). Video heads will be covered for a period of six months.
- Six months on all pan and tilts, scanners, or preset lenses used in continuous motion applications (preset scan, tour, and auto scan modes).

Pelco will warrant all replacement parts and repairs for 90 days from the date of Pelco shipment. All goods requiring warranty repair shall be sent freight prepaid to a Pelco designated location. Repairs made necessary by reason of misuse, alteration, normal wear, or accident are not covered under this warranty.

Pelco assumes no risk and shall be subject to no liability for damages or loss resulting from the specific use or application made of the Products. Pelco's liability for any claim, whether based on breach of contract, negligence, infringement of any rights of any party or product liability, relating to the Products shall not exceed the price paid by the Dealer to Pelco for such Products. In no event will Pelco be liable for any special, incidental, or consequential damages (including loss of use, loss of profit, and claims of third parties) however caused, whether by the negligence of Pelco or otherwise.

The above warranty provides the Dealer with specific legal rights. The Dealer may also have additional rights, which are subject to variation from state to state.

If a warranty repair is required, the Dealer must contact Pelco at (800) 289-9100 or (559) 292-1981 to obtain a Repair Authorization number (RA), and provide the following information:

1. Model and serial number
2. Date of shipment, P.O. number, sales order number, or Pelco invoice number
3. Details of the defect or problem

If there is a dispute regarding the warranty of a product that does not fall under the warranty conditions stated above, please include a written explanation with the product when returned.

Method of return shipment shall be the same or equal to the method by which the item was received by Pelco.

## RETURNS

To expedite parts returned for repair or credit, please call Pelco at (800) 289-9100 or (559) 292-1981 to obtain an authorization number (CA number if returned for credit, and RA number if returned for repair) and designated return location.

All merchandise returned for credit may be subject to a 20 percent restocking and refurbishing charge.

Goods returned for repair or credit should be clearly identified with the assigned CA or RA number and freight should be prepaid.

1-8-08

## REVISION HISTORY

Manual #	Date	Comments
C2403M	2/05	Original version.
C2403M-A	4/05	Varifocal camera case redesigned. Replaced 8-32 x 0.5-inch screws with 8-32 x 0.375-inch screws per ECO 05-10876.
C2403M-B	5/05	Added information for setting the jumper when using 12 VDC, and revised dimension drawing to show mounting hole pattern.
C2403M-C	10/05	Revise switch setting-descriptions for varifocal lens. Added WEEE statement.
C2403M-D	1/06	Updated factory switch settings for varifocal lens. Updated wiring information.
C2403M-E	2/08	Revised manual for fixed focus color cameras.

Pelco, the Pelco logo, Camclosure, DigitalSENTRY, Endura, Esprit, ExSite, Genex, Intelli-M, Legacy, and Spectra are registered trademarks of Pelco, Inc. Spectra III is a trademark of Pelco, Inc. © Copyright 2008, Pelco, Inc. All rights reserved. DLP is a registered trademark of Texas Instruments, Inc.



Worldwide Headquarters  
3500 Pelco Way  
Clovis, California 93612 USA

USA & Canada  
Tel: 800/289-9100  
Fax: 800/289-9150  
International  
Tel: 1-559/292-1981  
Fax: 1-559/348-1120

[www.pelco.com](http://www.pelco.com)

ISO9001

Australia | Finland | France | Germany | Italy | Macau | The Netherlands | Russia | Singapore  
South Africa | Spain | Sweden | United Arab Emirates | United Kingdom | United States



## Free Manuals Download Website

<http://myh66.com>

<http://usermanuals.us>

<http://www.somanuals.com>

<http://www.4manuals.cc>

<http://www.manual-lib.com>

<http://www.404manual.com>

<http://www.luxmanual.com>

<http://aubethermostatmanual.com>

Golf course search by state

<http://golfingnear.com>

Email search by domain

<http://emailbydomain.com>

Auto manuals search

<http://auto.somanuals.com>

TV manuals search

<http://tv.somanuals.com>