



Precision Shooting Equipment, Inc.

Compound Bow User's Guide

Thank you from the entire PSE family for purchasing a PSE bow. Your PSE bow was manufactured from the finest materials available and hand-crafted with pride in the USA. With proper care and use you will enjoy this product for years to come.

We at PSE wish you much success in the archery field you have chosen to pursue.

Please read this entire booklet before shooting or adjusting your bow.

Remember, most adjustments to a compound bow should be made in a bow press. Whenever shooting a bow, be certain of your target as well as what else lies downrange.

BOW TERMINOLOGY

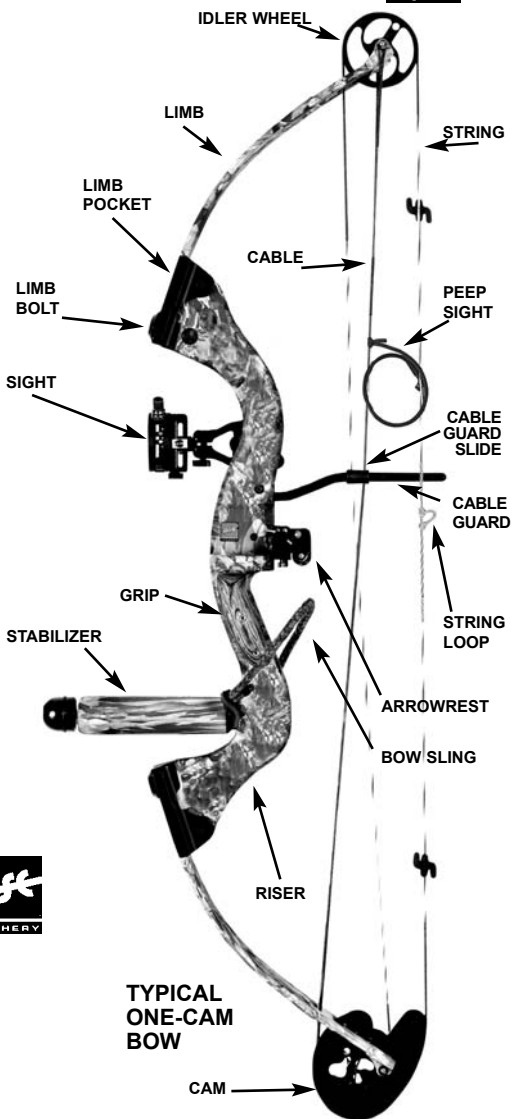

REGISTRATION



Fill out the reverse side of this page completely, remove it, and mail to:

PSE Warranty Registration
P.O. Box 5487
Tucson, AZ 85703

PN 94418
Rev. 11/04



Your local Authorized PSE Dealer is your best source for information and assistance.

ARCHERY

Visit them for these and other typical services:

1. Adjusting draw length and draw weight
2. Adjusting / changing let-off
3. Replacing / servicing strings and cables
4. All aspects of bow tuning
5. Correct arrow selection
6. Mounting new accessories
7. Adjusting tiller

IMPORTANT WARRANTY REGISTRATION

**THIS FORM MUST BE RECEIVED BY PSE WITHIN
30 DAYS OF PURCHASE TO ACTIVATE WARRANTY**

SERIAL # OF BOW _____

BOW MODEL _____

NAME _____

ADDRESS _____

ADDRESS _____ APT _____

CITY _____ STATE _____

COUNTRY _____ POSTAL CODE _____

EMAIL ADDRESS _____

DATE PURCHASED ____ / ____ / ____ PHONE (____) _____

**MAIL TO: PSE WARRANTY REGISTRATION
 P. O. BOX 5487
 TUCSON, AZ 85703**





Precision Shooting Equipment, Inc.

Compound Bow User's Guide

Thank you from the entire PSE family for purchasing a PSE bow. Your PSE bow was manufactured from the finest materials available and hand-crafted with pride in the USA. With proper care and use you will enjoy this product for years to come.

We at PSE wish you much success in the archery field you have chosen to pursue.

Please read this entire booklet before shooting or adjusting your bow.

Remember, most adjustments to a compound bow should be made in a bow press. Whenever shooting a bow, be certain of your target as well as what else lies downrange.

BOW TERMINOLOGY

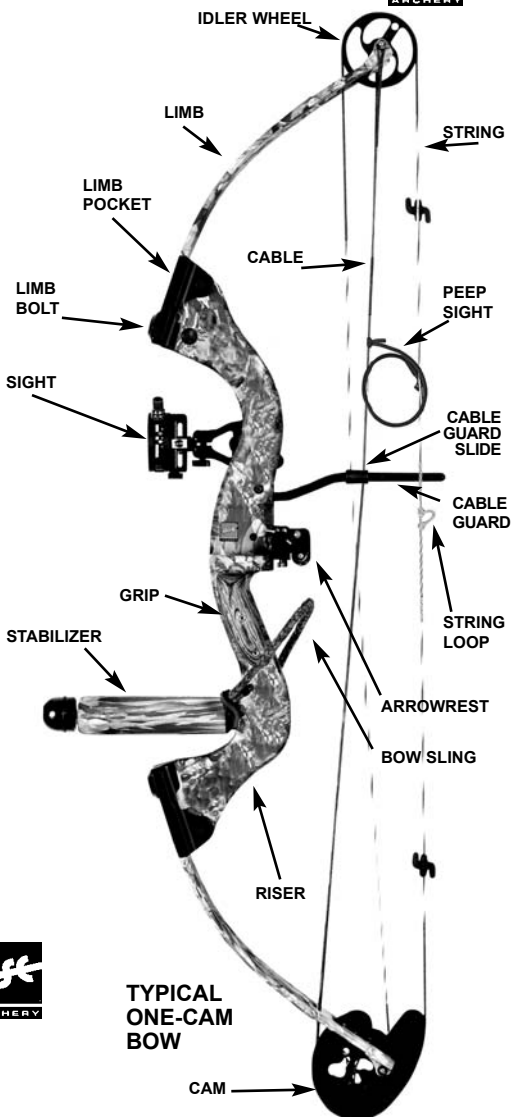

CONTACT US:



520-884-9065

www.pse-archery.com

TYPICAL
ONE-CAM
BOW

PN 94418
Rev. 11/04

GENERAL OPERATING INSTRUCTIONS



- Always inspect your bow thoroughly before each shooting session to insure that it is in good working order. Check for worn or missing components and have them replaced as required, i.e. bushings, spacers, etc.
- Inspect your arrows to insure that they are straight and that each nock is in good condition. A cracked nock can break when fired from the bow and cause the bow to "dry fire" resulting in possible injury to the archer and damage to the bow.
- When purchasing arrows for your bow, consult the selection chart from the arrow manufacturer and select the correct arrow for your application. Always use an arrow that meets the weight requirement marked on the specification label on the lower limb of your bow. Failure to do so could cause personal injury and damage to your bow.

BOW MAINTENANCE



Your PSE bow will give you many years of service if maintained and cared for properly.

IMPORTANT: Before servicing any PSE bow in a bow press, back out each limb bolt 4 complete turns from bottomed position.

- Keep synthetic cables and strings waxed. Apply bow string wax to your synthetic cables and string before each shooting session.
- Strings and cables must be replaced periodically. A worn cable or string can suddenly break causing serious injury to the archer and damage to the bow. It is recommended that the string and cables be replaced at least every 5,000 shots or 12 months.
- Always store your bow in a cool dry place. High temperatures, such as those that can occur in a truck or interior of a vehicle, can cause serious damage to your bow.
- After use in high humidity or damp conditions, wipe metal components of bow with a light oil.



Get the PSE BOW OWNER'S GUIDE video at www.pse-archery.com. This entertaining and informative video covers all aspects of modern bow technology. 60 minutes.

As with any weapon, safe operation of your PSE bow must always be the highest priority. **ALWAYS WEAR SAFETY GLASSES WHEN HANDLING A BOW.** Do not attempt to use your bow without proper instruction. Doing so can result in serious injury.

a. Never "dry-fire" any bow. Dry-fire is to draw and release the bowstring without an arrow on the string. Dry-firing will likely cause damage to the bow and serious injury to the archer.

b. Always be sure of your intended target as well as what lies behind the target area. An arrow can travel a considerable distance, so it is important to have a safe and sound backstop.

c. If you draw a bow and need to let it down, do so in a slow and careful manner. Keep your support arm straight and prepare for a rapid and violent let-down. Avoid hitting your hand on protruding accessories such as the cable guard or quiver. Keep your head and face back and out of danger during let-down. Never draw a bow with a peak weight above your comfort level. Always use a bow sling when drawing a bow.

d. Never modify any part of the bow or its components by drilling extra holes or removing material. This voids the warranty and presents safety problems.

SETTING-UP YOUR BOW

NOCKING POINT PLACEMENT:

Finger shooters: For the initial setting, install the nocking point on the bowstring approximately 5/16" plus the arrow width above a point where a horizontal line from the rest intersects the string.

Release Aid shooters: Install the nocking point the width of the arrow above a point where a horizontal line from the rest intersects the string. When the arrow is in position on the rest the arrownock should fit snug against the bottom of the nocking point.

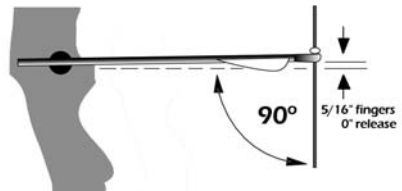

ARROWREST ADJUSTMENT:

The in/out position of the arrowrest should be adjusted so that the arrow is in alignment with the string when shooting with a release aid. The arrow tip should be ~1/2 shaft diameter left of center on a right-handed bow, (opposite for left-handed) when shooting with fingers.

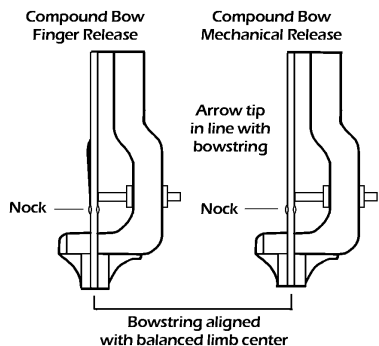

SIGHT ADJUSTMENT:

When adjusting the sight pin locations, always remember to "follow the group". That is, if the shot group is to the left of the target, move the sight pins to the left. If the shot group is low, move the sight pins down.

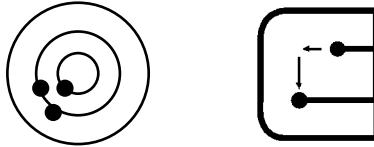

CABLE GUARD ADJUSTMENT & INSTALLATION:

Install the cable guard as shown in Figure A.

Adjust the cable guard so the cables just clear the arrow vanes. On bows using an offset cable guard rod, adjustments must be done with the rod in the up position (approximately 1 o'clock) as shown in Figure B (11 o'clock for left handed bows).

Excessive arrow clearance may cause the cable to track incorrectly on the wheels and cause personal injury and/or damage to the bow.

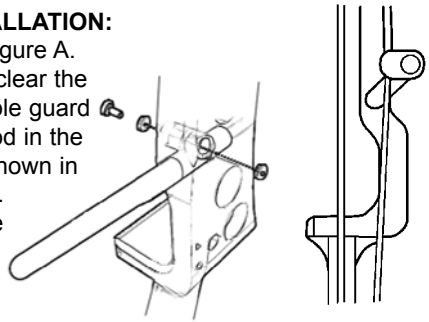
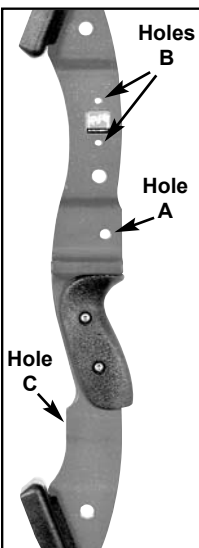

Figure A

Figure B

INSTALLATION OF ACCESSORIES



Arrowrest/Overdraw: The arrowrest or overdraw should be installed according to the instructions received with the product. It is usually mounted to the riser in the threaded hole on the side opposite the shelf (hole "A") using the hardware provided with the arrowrest or overdraw.

Sight: The sight should be installed according to the instructions received with the product. It is usually mounted to the riser in the threaded holes (holes "B") on the side opposite the shelf using the hardware provided with the sight.

Stabilizer: The stabilizer should be mounted according to the manufacturer's recommendation. It is usually mounted in the threaded hole on the front of the riser (hole "C").

Bow Sling: The bow sling attaches to the riser of the bow generally with the stabilizer. If a stabilizer is not used, attach the sling to the riser with the correct sized bolt using the hole provided for the stabilizer (hole "C").

OTHER ADJUSTMENTS



Draw Weight: Your bow is factory-set to within 2 lbs. of the peak draw weight indicated on the label on the lower limb of the bow. Changes in draw weight can be made by turning the limb bolt in or out. Before making any changes in weight, turn the limb bolt clockwise until it no longer moves. Never use extreme torque when turning the bolt or damage to the limb may occur. The limb bolt then may be turned counterclockwise to obtain the desired weight, **but NEVER more than 4 turns or revolutions.** Adjust each limb exactly the same. CAUTION: On some bow models, the limb bolt locking screw **MUST** be loosened **BEFORE** adjusting.

Wheels/Cams: Many PSE wheels and cams have adjustable features. Each one comes from the factory set-up and ready to use but there may be occasions where you need to adjust the characteristics of your bow. In some cases you will need a PSE Tune Chart to determine what to adjust, and you may need to see a PSE Dealer for information. If you are not sure of the adjustment you are making, stop and see your PSE Dealer for assistance. In all cases, an appropriate bow press will be needed to make adjustments to cams and wheels. If you do not have an appropriate press, see your PSE Dealer.

Your Authorized PSE Dealer is supplied with technical information on PSE bows and cams. Please see your Dealer for assistance when making these adjustments.

CAM ADJUSTMENTS



Centerfire™

Centerfire™, Rimfire™ & NRG™ One Cams:

Draw Length: To change the draw length in 1" increments the module must be changed. See your PSE Dealer for information on how to obtain a replacement module. For minor changes in draw length, the bow must be placed in a suitable bow press and with tension relieved from the string/cable.



NRG™

For Centerfire™: Move the string from the "B" peg to the "C" peg to shorten draw by approximately $\frac{1}{4}$ " or to the "A" peg to lengthen draw by approximately $\frac{1}{4}$ ". The string can also be moved from the "2" peg to the "3" peg to shorten draw by $\frac{1}{4}$ " or to the "1" peg to lengthen draw by approximately $\frac{1}{4}$ ".



Rimfire™

For NRG™: Each side of the cam has two posts. Moving the string from the post with the dot to the post without a dot on the string side of the cam increases the draw length by approximately $\frac{3}{8}$ ". Moving the string from the post with the dot to the post without a dot on the take-up side of the cam decreases the draw length by approximately $\frac{1}{8}$ ".

For Rimfire™: There are two posts on the string side of the cam. The bow is shipped from the factory with the string on the far peg. Moving the string to the peg nearest the string groove increases draw by approximately $\frac{1}{2}$ ".

CAM ADJUSTMENTS



Draw Stop: The position of the draw stop must match the size of the module. If the bow is equipped with a size 7 module, the draw stop must be attached to the cam using the holes marked with the number 7. The size 4 Centerfire™ and Rimfire™ modules are the only exceptions to this rule as the module and stop are one piece.

Let-off: Let-off adjustment is part of the draw stop. To adjust from 80% to 65%, remove both screws which hold the stop to the cam, flip the stop over so that the cable will contact the side marked 65% at full draw and reinstall the screws. There is no let-off adjustment for the size 4 Centerfire™ module. The Rimfire™ cam has no provision for let-off adjustment.



**NRG™ Hybrid Cam
TOP**

NRG™ Hybrid Cam:

Draw Length: To change the draw length in 1" increments the modules must be changed on both the top and bottom cams. See your PSE dealer for information on how to obtain replacement modules. For minor changes, the bow must be placed in a suitable bow press and with the tension relieved from the string/cable, move the string to the "+" peg on the top cam to increase the draw length by approximately 3/8" or to the "-" peg to decrease the draw length by approximately 3/8".



**NRG™ Hybrid Cam
BOTTOM**

Draw Stop: The draw stop is located on the bottom cam and is attached with two screws. It must be placed in the position that corresponds with the modules. For example, if the bow is equipped with size 7 modules, the draw stop must be secured firmly with the screws in the number "7" holes.

Let-off: The let-off adjustment is part of the draw stop. To adjust from the factory setting of 80% to 65%, remove both screws which hold the stop to the cam and flip it over so that the cable will contact the side marked "65" at full draw and reinstall the screws. Note: Changing the let-off from 80% to 65% shortens the draw length by approximately 3/8".



Synergy 4™

Synergy 4™:

Draw Length: The draw length is adjusted by placing the bow in an appropriate bow press and relieving the tension from the string and cables. Shortening the effective length of the string shortens the draw length and lengthening it lengthens the draw. The bow is shipped from the factory with the string in the middle slot. Moving the string one slot on one of the wheels changes the draw length $\frac{1}{4}$ ". Moving the string one slot on each of the two wheels makes a change of $\frac{1}{2}$ ". The cables can be moved to change the draw length by $\frac{1}{2}$ ". Adjustments to the cable must be made on both wheels. Remember, shortening the draw length decreases the draw weight and lengthening the draw length increases the draw weight.



Stage 3™

Stage 3™:

Draw Length: The draw length is adjusted by placing the bow in an appropriate bow press and relieving the tension from the string and cables. Move the string to the slot that will shorten the effective length of the string to shorten the draw length by $\frac{1}{2}$ " per wheel. Move the string to the slot that will lengthen the effective length of the string to lengthen the draw of the bow by $\frac{1}{2}$ " per wheel.

NOVA ONE-CAM:

Draw Length: The draw length may be adjusted by placing the bow in an appropriate bow press relieving the tension from the string and cable. Moving the string from the center peg to the peg furthest from the string groove shortens the draw length by approximately $\frac{1}{2}$ ". Moving it to the peg closest to the string groove increases the draw length by approximately $\frac{1}{2}$ ".

LIMITED LIFETIME WARRANTY



ALL PSE MANUFACTURED BOWS / ACCESSORIES / KING PRODUCTS

Each PSE Bow, Accessory and King product is backed by a PSE Limited Lifetime Warranty to the original owner for the life of the product. Product will be replaced or repaired to restore it to its original performance. Cables, strings, or wearable items are not covered by this warranty.

Evidence of abuse, mishandling, misuse, or alteration to any PSE product voids any claim to warranty. PSE specifications on strings and harness must be adhered to.

PSE cannot be held responsible for injury or product failure resulting from improper use or neglect of maintenance.

All bows must undergo string and cable changes every 5,000 shots or every 12 months to maintain PSE warranty coverage. Total arrow weight must be in accordance with the recommendations made by the Archery Trade Association (ATA) for minimum arrow weight/bow peak weight. Overstressing PSE compound bows by using arrows lighter than ATA recommendation will void warranty and may cause damage to the bow or injury to the shooter.

PSE makes no other claims either expressed or implied. In the interest of product improvement and consumer safety, PSE reserves the right to make changes in product design, color, and specifications without notice.

PATENT INFORMATION



One or more of the following patents may apply:

4,649,889	4,967,721	5,241,945	5,365,650	5,507,270	6,176,231 B1
4,697,350	5,005,554	5,243,958	5,377,658	5,657,739	6,360,735
4,735,667	5,020,507 B1	5,280,779	5,469,834	5,678,529	6,493,951 B1
4,739,744	5,040,520	5,301,651	5,479,712	5,762,060	6,792,930
4,748,962 B1	5,054,462	5,307,787	5,487,373	5,914,775	DES 429,309
4,762,112	5,123,396	5,335,644	5,495,843	5,960,778	RE-36,942
4,947,823	5,190,022	5,339,790	5,505,185	6,112,732	

PREFERRED PARTNERS



Mossy Oak®

www.mossyoak.com

Primos®

www.primos.com

Swarovski Optik®

www.swarovskioptik.com

Vibracheck®

www.vibracheck.com

YES, send me two videos and my free cap!

Please select two videos from below:

WHITETAIL FEVER 3 VHS 41270 DVD 41296 **PETE'S JOURNAL** VHS ONLY 41045

Boar'n the USA VHS 41266 DVD 41295 **Free Hat** 45354

PURSUIN' THE BRUIN DVD 41303 VHS 45081 DVD 41302 **HOLDING STEADY** VHS 45081 DVD 41302

BOWHUNTING THE WILD WEST 3 VHS 41351 DVD 41347

Name _____

Address _____

City _____ State / Province _____

Postal Code (Zip) _____ Country _____ Daytime Phone (____) _____

MC Visa Exp _____

CREDIT CARD NUMBER

OR INCLUDE CHECK OR MONEY ORDER

SIGNATURE _____

Mail to: PSE P.O. Box 5487 Tucson, AZ 85703

Shipping & Handling	\$ 18.99
Total (non-AZ residents)	3.95
AZ residents add	\$22.94
Total (AZ residents)	1.32
	24.26

THANK YOU FOR SELECTING PSE.

\$18⁹⁹

*Act now on this
one-time offer*

Buy TWO of these
popular PSE videos
and receive a free cap!

Cap style shown may change

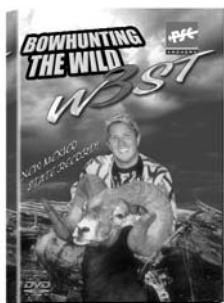

BOWHUNTING THE WILD WEST 3

From Alaska to Arizona,
some of the best hunts
in the West. DVD or VHS



PETE'S JOURNAL

Journey through the
years with Pete Shepley
on his best hunts and his
latest African trip. VHS



PURSUIN' THE BRUIN

North America's most
dangerous mammal amid the
spectacular Southwestern
Alaska tundra. DVD or VHS



Boar'n the U.S.A

From Florida to
California PSE is
hunt'n the wild Boar.
DVD or VHS



HOLDING STEADY

Learn to really aim
your bow.
DVD or VHS



WHITETAIL FEVER 3

Twelve hunts in twelve
locations across
North America.
DVD or VHS

Free Manuals Download Website

<http://myh66.com>

<http://usermanuals.us>

<http://www.somanuals.com>

<http://www.4manuals.cc>

<http://www.manual-lib.com>

<http://www.404manual.com>

<http://www.luxmanual.com>

<http://aubethermostatmanual.com>

Golf course search by state

<http://golfingnear.com>

Email search by domain

<http://emailbydomain.com>

Auto manuals search

<http://auto.somanuals.com>

TV manuals search

<http://tv.somanuals.com>