



PowerScan™ RF

Handheld Bar Code Scanner



User's Guide

PSC Scanning, Inc.

959 Terry Street
Eugene, Oregon 97402
Telephone: (541) 683-5700
Telefax: (541) 345-7140

PSC, the PSC logo, Quadralogic II and PowerScan are registered trademarks of PSC Inc. All other trademarks and trade names referred to herein are property of their respective owners.

All rights reserved. No part of the contents of this documentation or the procedures described therein may be reproduced or transmitted in any form or by any means without prior written permission of PSC Inc. Owners of PSC Inc.'s products are hereby granted non-exclusive, revocable license to reproduce and transmit this documentation for the purchaser's own internal business purposes. Purchaser shall not remove or alter any proprietary notices, including copyright notices, contained on this documentation and shall ensure that all notices appear on any reproductions of the documentation.

Should future revisions of this manual be published, you can acquire printed versions by contacting PSC Customer Administration. Electronic versions will either be downloadable from the PSC web site (www.pscnet.com) or provided on appropriate media. If you visit our web site and would like to make comments or suggestions about this or other PSC publications, please let us know via the "Contact PSC" page.

Disclaimer

Reasonable measures have been taken to ensure that the information included in this manual is complete and accurate. However, PSC reserves the right to change any specification at any time without prior notice.

Table of Contents

Unpack and Inspect Your Scanner	1
References.....	1
Quick Start Instructions	1
Installing the Battery	2
Verifying Scanner Operation	3
Connecting the Base Station to the Host Terminal.....	3
Linking the Scanner to a Base Station	5
Verifying Scanner-to-Base Station Communications.....	6
Using the PowerScan RF System.....	7
Battery Charging and Maintenance.....	7
Tips for Extending Battery Life	8
Disposing of Batteries.....	8
Four Station Charger.....	9
How to Scan.....	10
Depth of Field	11
LED and Beeper Indications	15
Active Symbologies	19
Enhanced Scanning for Hard-to-Read Bar Codes	19
Laser Cautions	21
Radio Frequency Interference.....	22
Maintenance.....	23
Troubleshooting	24
Sample Bar Codes.....	25

Unpack and Inspect Your Scanner

After unpacking your new scanner, check the contents of the shipping carton to ensure all the items you ordered are included:

- PowerScan™ RF handheld scanner
- Battery Pack(s)
- User's Guide (this manual)
- Optional Accessories that you ordered. (The scanner can be purchased with or without accessory kits.)

If your package contains wrong or missing components, contact your place of purchase. If there are damaged components, immediately file a claim with the carrier. You may want to save your packing material in case you need to ship the scanner at some later time.

References

For more information about this product, its associated publications, software, and accessories, visit our website listed on the back cover of this manual.

Quick Start Instructions

The basic steps below must be performed to set up the RF scanner. Each of these steps is detailed in this manual.

- Installing the Battery
- Verifying Scanner Operation
- Connecting the Base Station to the Host Terminal
- Linking the Scanner to a Base Station
- Verifying Scanner-to-Base Station Communications

Installing the Battery



NOTE

To assure maximum usage, batteries should always be fully charged before their initial use. (See *Battery Charging and Maintenance* on page 7.)

Orient the battery as shown in Figure 1, then push it into the scanner until it snaps in place. To remove the battery, push in on the release tabs on both sides of the battery's base and pull it straight out of the scanner.

Figure 1. Installing the Battery

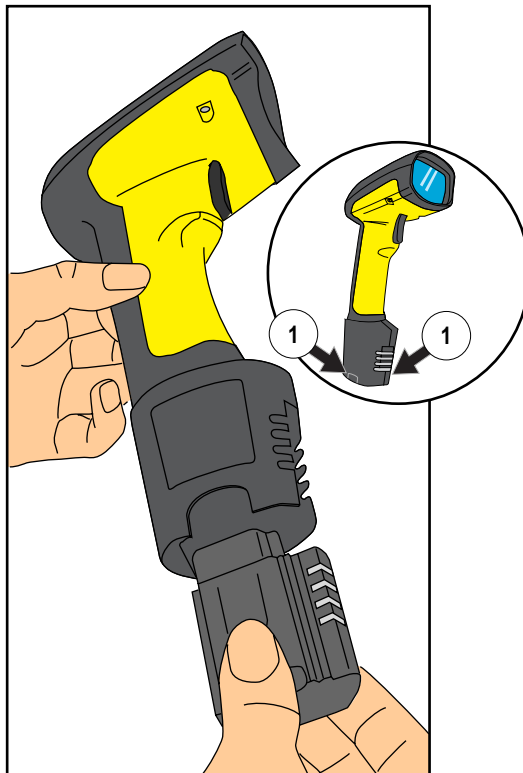

1. Battery Release Tabs

Verifying Scanner Operation

Once a charged battery has been installed in the scanner, scan the sample bar codes in the back of this manual that correspond to the symbologies your scanner is programmed to read. If unsure how to do this, see the section on *How to Scan* in this manual. The system may signal with one or a combination of indicators depending upon how the scanner and Base Station are programmed to respond (see *LED and Beeper Indications* for details). If your scanner fails to read a sample bar code of a symbology it's programmed to read, turn to the section titled, *Troubleshooting*.

Connecting the Base Station to the Host Terminal



NOTE

It is important that the interface (I/F) cable be connected to the Base Station prior to applying power to the system. This is because the interface type (RS-232, IBM, Keyboard Wedge, etc.) is selected by the Base Station subject to the I/F cable it is connected to at the time of power-up.

1. Connect the I/F cable to the Base Station (see Figure 2A). The I/F cable is inserted into the connector and the cable retainer clip is rotated over the cable overmold until the retainer snaps in place (see Figure 2B). To disconnect the cable, push in on the retainer (away from the catch on the plastic wall) to release it and enable it to swing upward, allowing the cable to be pulled free (see Figure 2C).

Figure 2. Connecting/Disconnecting the Interface (I/F) Cable

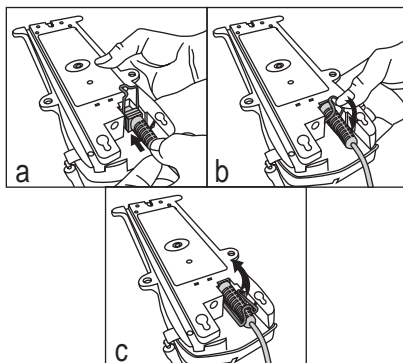

2. Consult your Host Terminal manual to determine the required communication parameters for the Host Terminal (e.g., baud rate, parity, etc.) and, if necessary, modify the programmed parameters to be compatible with those requirements. Scanner and Base Station programming is performed using one of the following:

- *Configurator Express™ Programming Software*
- *PowerScan™ Bar Code Scanner Programming Guide*



NOTE

See *References* for more information about how to obtain software and manuals for this product.



CAUTION

The Host Terminal manual should also be consulted as to whether power must be turned off before connecting peripheral devices. Ensure that the correct procedure is followed to avoid damage to equipment or interruption of system functions.

3. Connect the I/F cable to the proper port on the Host Terminal (check your Host Terminal manual to determine hardware requirements).
4. Connect the AC Adapter's power cord at the Base Station and plug the AC/DC adapter in at the wall outlet (see Figure 3). The Base Station's POWER LED should be illuminated when the unit is properly connected to power.

Figure 3. Connecting Power to the Base Station

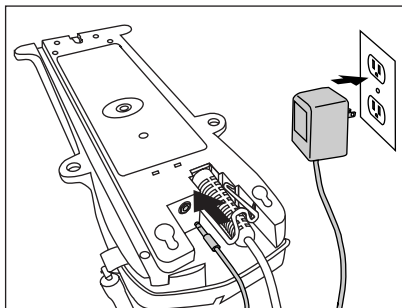

5. Apply power to the Host Terminal.
6. Verify communication with the Host Terminal by aiming the linked scanner at a sample bar code from the back pages of this manual, and pulling the trigger (see *How to Scan* for tips about scanning bar codes). Confirm that the scanner/Base Station sent the data to the host terminal. If not, see the section, *Troubleshooting*. Once all communications are verified, the system is ready for use.

Linking the Scanner to a Base Station

To link a scanner to a Base Station, simply scan the Base Station ID bar code located on the top of the desired Base Station. As the scanner searches for the Base Station, a short beep is heard as it seeks for the correct channel. When the Base Station responds to the request, the scanner's beeper will either sound a "Link Granted," or "Link Denied" signal (see the section, *LED and Beeper Indications* for more information).

The existing Base Station system configuration can be automatically downloaded to the scanner. This automatic download feature is configurable and can be disabled. See the Systems Manual for more information about this feature. If downloading occurs, a slight delay with link verification announcement will occur.



CAUTION

Since a new/replacement scanner may have been shipped with a custom configuration or may have been modified with other special programming, it may not be desirable to download a potentially older configuration from an existing Base Station. In this case, reference the Systems Manual, or the *Configurator Express™* On-Screen Programming Software and consider uploading the scanner's newer configuration to the Base Station prior to linking.

Verifying Scanner-to-Base Station Communications

Point the linked scanner at a sample bar code from the back pages of this manual, and pull the trigger (see *How to Scan* for tips on scanning bar codes). Watch the TX/RX (transmit/receive) indicator LED on the Base Station and/or scanner green LED while scanning the bar code. The LEDs should flash momentarily as the two devices communicate. If no communication is indicated, refer to the troubleshooting section of the Systems Manual.

When the scanner is programmed to do so, communication can also be indicated by a second "acknowledgement" tone¹ that is sounded after a "good read" tone. If a transmission error beep (warble) is heard following a "good read" tone instead of the single acknowledgement tone, communication between the devices may have failed². Refer to the sections *Using the PowerScan RF System*, and *Troubleshooting* for possible remedies, should this occur.

-
1. See *LED and Beeper Indications* for more details about beeper signals.
 2. Other reasons for a "warble" are that the Base Station may be configured differently than the scanner, or that the system's interface doesn't support the symbology (bar code type) you're trying to scan.

Using the PowerScan RF System

This section covers the following topics:

- Battery Charging and Maintenance
- How to Scan
- LED and Beeper Indications

Battery Charging and Maintenance



NOTE

When the scanner is in use, a low battery condition is indicated by a repeated two-flash signal from the scanner's green LED every time the trigger is pulled before the laser is enabled. This indicator may have been disabled via custom programming. See *LED and Beeper Indications* for more information.

Seat the scanner in the Base Station as shown in Figure 4, ensuring that the battery fully engages the station's metal contacts. The CHARGE LED on the Base Station should flash, indicating the battery is charging.

Figure 4. Charging the Battery

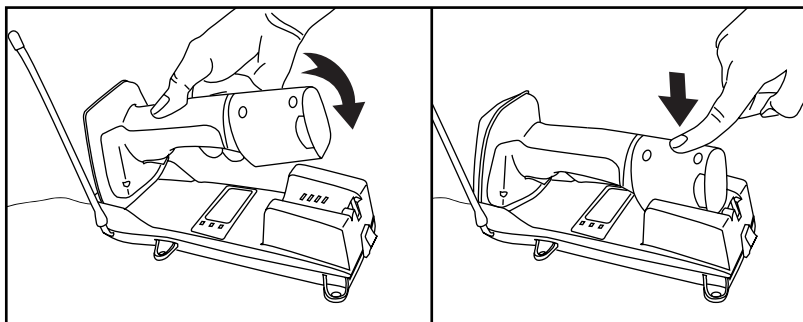

Rapid flashing indicates that charging is taking place. Rapid charging occurs when the battery temperature is between 10°C (50°F) and 46°C (115°F), and/or voltage of the battery is between 2.0 and 3.2V. Charge time is less than 4.2 hours. Rapid charge ends with the battery at approximately 90 to 95% capacity. The CHARGE LED remains on steady when trickle charging or after the charge cycle is complete.



NOTE

A scanner may be charged simultaneously while other scanners are in use with the Base Station.



NOTE

Batteries will not charge if their temperature is below 0°C (30°F). If a battery that is too cold is inserted into the Base Station, the Charge LED will not illuminate.

Tips for Extending Battery Life

Nickel Metal Hydride (NiMH) batteries will better hold a charge if allowed to discharge at least once a week. The chemical reactions that correspond to charge and discharge in a rechargeable battery should occur to obtain the maximum number of charge/discharge cycles in the battery. If a battery is removed from the scanner and stored, it should be fully charged when stored. Batteries will lose the ability to hold a charge when stored for long periods of time (weeks, months, or longer).

Batteries will typically have about 30% charge capacity when shipped. To assure maximum usage, the battery should be fully charged before use.

Store your battery in a cool dry place. Do not leave your battery exposed to direct sunlight or temperatures below 0°C (30°F) and above 38°C (100°F).

Disposing of Batteries

There presently are no US, North America or World disposal requirements for NiMH batteries, so when they won't hold a charge anymore, the batteries can be disposed of, preferably through a recycling center.

Four Station Charger

If you have a Four Station Charger, batteries are inserted for charging as shown in Figure 5. A 90% rapid charge can be achieved in only two hours when using this optional accessory, half the time than when a Base Station is used for charging. The LEDs at each battery station operate the same as the CHARGE LED on the Base Station, with rapid flashing indicating that rapid charging is taking place and on steady during trickle charging or when the rapid charge cycle is finished.



NOTE

If you insert a battery into the Four Station Charger and no LEDs illuminate, the battery may be too cold. Batteries must be at 0°C or higher to charge. Do not attempt to charge cold batteries, since placing them in the charger will curtail the charging of other batteries already present in the unit.

Figure 5. Using the Four Station Charger Accessory

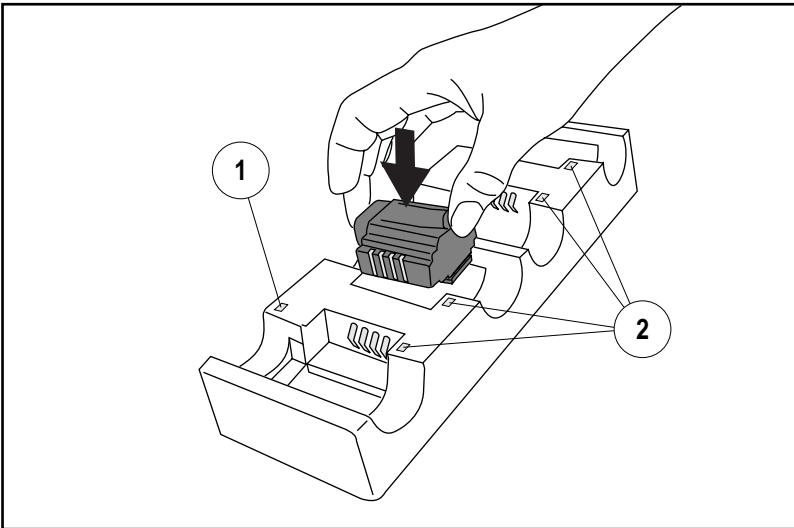

1. Device Power LED

2. Station Charge LEDs

How to Scan

Figure 6 illustrates some tips to help get the best scanning results:

1. The scanner must be pointed at a slight angle to the bar code. Do not hold the scanner perpendicular to the bar code.
2. The laser beam must cross the entire bar code. The scanner cannot correctly read if the the entire bar code is not scanned.

Figure 6. Scanning Tips

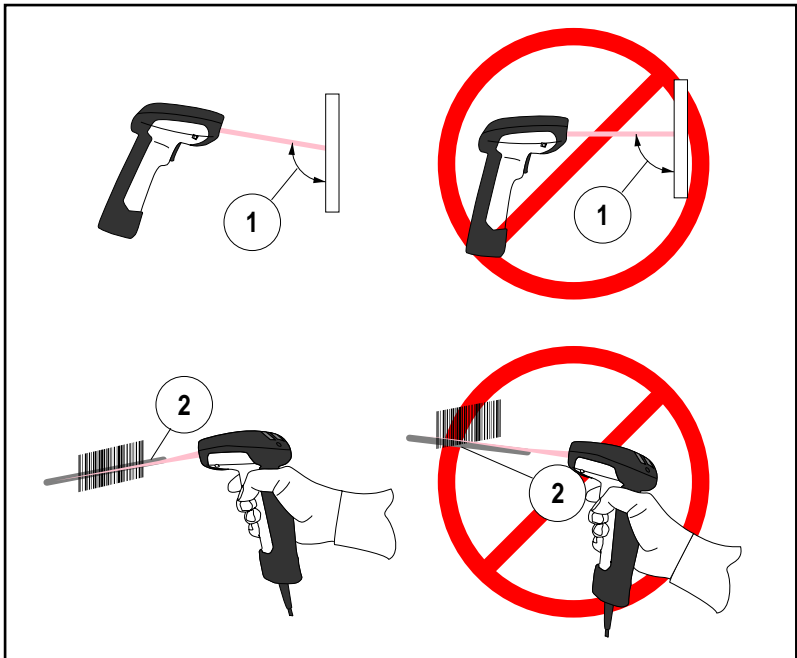

Depth of Field

There are currently four different range models for the scanner. Depending upon the model type of your scanner, you'll need to hold the unit at a given distance from the bar code to achieve optimum scanning results. The following diagrams provide depth of field information for each of the models when scanning grade A, Code 39 bar codes: Standard Range (SR), High Density (HD), Long Range (LR) and Extra Long Range (XLR).

Definition of a "mil"

A "mil" is equal to 0.001 inches. In the context of the illustrations in this section, a mil represents the minimum bar code element width. Thus a 5 mil bar code would have a minimum element width of 5 mils (or 0.005 inches).



NOTE

Measurements are based on SR models set with the standard 28° scan width (as opposed to the Half Angle setting of 14°). Reference the Programming Manual for more information about the Half Angle feature.

Specifications are subject to change without notice.

Figure 7. Depth of Field (SR)

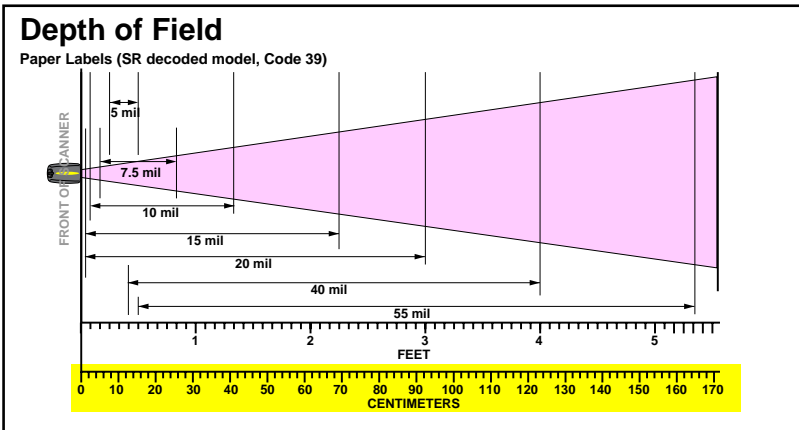



NOTE

See the section titled, *Definition of a "mil"* for more information about reading this chart. Measurements are based on HD models set with the standard 28° scan width (as opposed to the Half Angle setting of 14°). Reference the Programming Manual for more information about the Half Angle feature.

Specifications are subject to change without notice.

Figure 8. Depth of Field (HD)

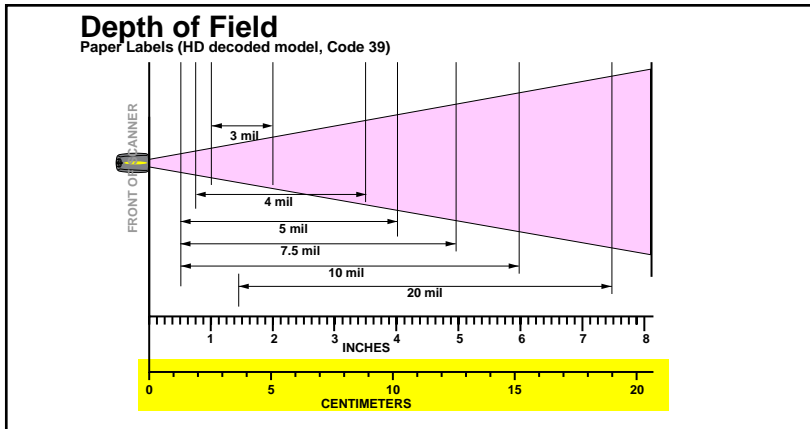



NOTE

See the section titled, *Definition of a "mil"* for more information about reading this chart. Measurements are based on LR models set with the a 14° scan width (as opposed to the alternate Full Angle setting of 28°). Reference the Programming Manual for more information about the Half Angle feature.

Specifications are subject to change without notice.

Figure 9. Depth of Field (LR)

Depth of Field

Paper Labels (LR decoded model, Code 39)

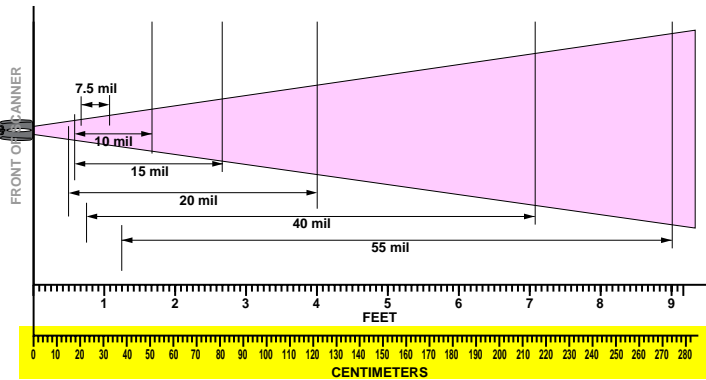

Reflective Labels (LR decoded model, Code 39)

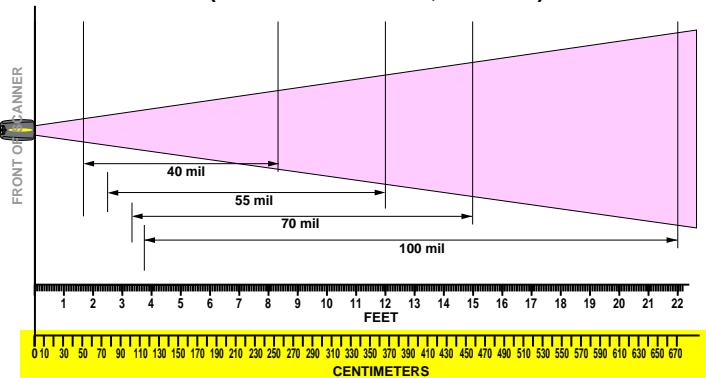



NOTE

See the section titled, *Definition of a "mil"* for more information about reading this chart. Measurements are based on XLR models set with a 10° scan angle width.

Specifications are subject to change without notice.

Figure 10. Depth of Field (XLR)

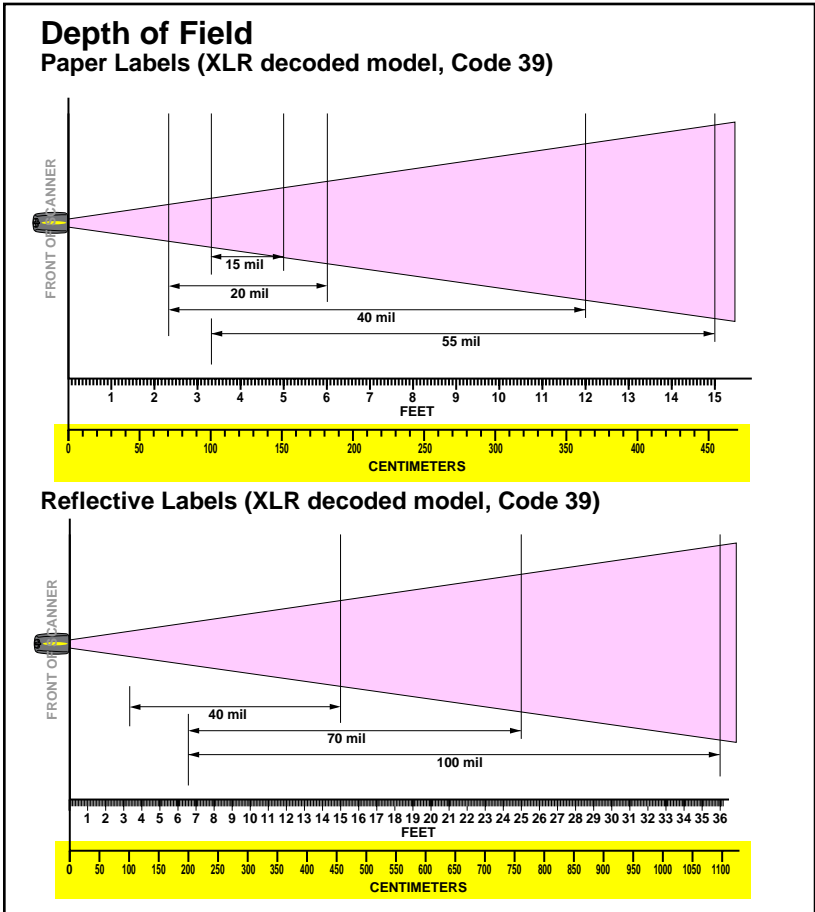

LED and Beeper Indications

The Base Station LED indicators and the scanner's LEDs and beeper are used to announce system status and perform other useful signals. The tables below list the default function of each of the various indicators.



NOTE

Some LED and beeper indications can be disabled or modified via scanner programming. The tables indicate the default behavior of the indicators, with shaded rows representing features that are programmable.

Table 1. Scanner GREEN LED Functions

LED INDICATION	DURATION	COMMENT
Disable Indication	100ms on, 900 ms off 	Indicates the scanner has been disabled.
Good Read Indication	500 ms on 	Indicates a bar code has been read and decoded.
Program Mode Indication	500 ms on, 500 ms off Continuous flashing 	Indicates the scanner is in Programming Mode.
Field Replaceable Unit (FRU) Indications	Varies. Consists of a long flash followed by multiple short flashes. 	Enables service technicians to identify Field Replaceable Unit (FRU) errors.
Low Battery Indication	Two flashes at 100 ms on, 350 ms off. 	Occurs at trigger pull before the laser is enabled. Indicates the battery is in need of recharging.

Table 2. Scanner YELLOW LED Functions







LED INDICATION	DURATION	COMMENT
Laser on indication	On Steady 	The yellow LED illuminates whenever the laser is on.

Table 3. Scanner BEEPER Functions

SPEAKER INDICATION	DURATION	COMMENT
Scanner Not Currently Linked	Six beeps consisting of 20 ms on, 20 ms off 	Indicates a bar code was read before the scanner was linked to a Base Station.
Good Read Beep	100 ms on (short) 250 ms on (medium)  500 ms on (long) 	Three programmable functions are available. This indicates a bar code has been read and decoded.
Partial Read Bip	20 ms on 	A very short beep ("bip") is sounded when one bar code of a two-bar code pair has been successfully decoded.
Base Station Acknowledgement Beep	100 ms on (short) 250 ms on (medium)  500 ms on (long) 	Indicates a successful bar code transmission to the host (configurable), a successful change of channel, or a successful transmission of a new configuration to the host.











SPEAKER INDICATION	DURATION	COMMENT
Transmission Error Beep	High, then low, then high, then low. 	Indicates unsuccessful transmission to the host.
Link Beep	Low, then medium, then high. 	Indicates a scanner has been successfully linked to a base station.
Unlink Beep	High, then medium, then low. 	Indicates a scanner has been successfully unlinked from a base station.
Field Replaceable Unit (FRU) Indications	Varies. Consists of a long tone followed by multiple short tones. 	Enables service technicians to identify Field Replaceable Unit (FRU) errors.

Table 4. Base Station LED Functions

LED INDICATION	DURATION	COMMENT
TX/RX (Transmit/Receive)	Lit for variable time ^a 	Indicates communications activity to or from the Base Station.
	Continuous rapid flashing at power-up 	Indicates a broken radio.
	Varies. Consists of a long flash followed by multiple short flashes. 	Enables service technicians to identify Field Replaceable Unit (FRU) errors.

LED INDICATION	DURATION	COMMENT
Charge (Battery)	Continuous flashing 	When a scanner is nested in the station, this indicates its battery is being quick charged.
	Lit Constantly 	When a scanner is nested in the station, this indicates its battery is at or near full charge.
	Not Lit	A scanner is not present or incorrectly inserted into the station. It can also mean the battery is below 0°C (too cold for charge)
Power	Lit Constantly 	Indicates that power is on.

- a. The LED remains on while the unit is actively processing code which requires a TX/RX to occur. The duration of the LED is dependent upon the length of the message.

Active Symbolologies

The active (enabled) bar code symbolologies in the standard factory defaults are:

- Code 39 (C39)
- Code 128 (C128)
- Interleaved 2 of 5 (I 2 of 5)

Your scanner should be pre-programmed with these standard factory default settings, unless...

...it was shipped to you programmed with unique, customer configuration settings.

...you or another user have made changes to scanner programming.

Enhanced Scanning for Hard-to-Read Bar Codes

Decoded scanners can be programmed to decode extremely poor quality bar codes by activating advanced Quadralogic II™ Decoding. To select this feature, see the Programming Guide.

Scanner programming can also be performed using your PC and the Configurator Express™ On-Screen Programming Kit.



NOTE

Information about manuals, kits and programming software for this product are available at our website. See the back cover for our web address.

Figure 11. Scanner Labeling and Nomenclature

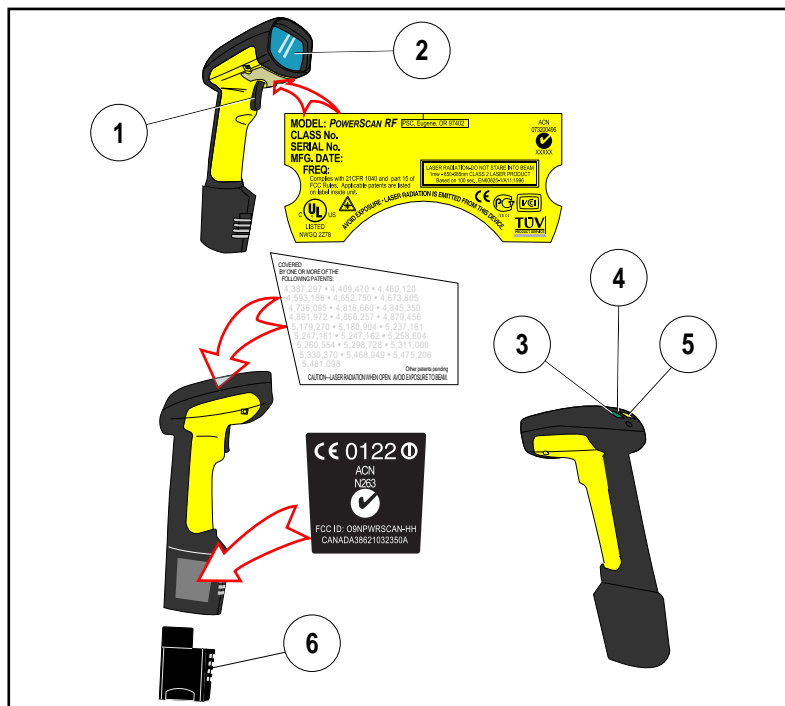

- | | |
|----------------|----------------|
| 1. Trigger | 4. Tether Hook |
| 2. Scan Window | 5. Yellow LED |
| 3. Green LED | 6. Battery |



NOTE

Figure 11 above shows label placement ONLY. For actual regulatory, patent and other applicable information, view the labels on the product itself, or call your nearest sales or service representative.

Laser Cautions

The PowerScan RF bar code scanner is certified in the U.S. to conform to the requirements of *DHHS/CDRH 21CFR Subchapter J for Class II laser products (SR and LR) and Class IIIa (XLR)*. Class II and IIIa products are not considered to be hazardous. The scanner contains a Visible Laser Diode (VLD) at a wavelength of 650-670 nanometers and is designed so that there can be no human access to harmful levels of laser light during normal operation, user maintenance, or during prescribed service operations.



CAUTION

In the unlikely event that a bright laser spot is experienced rather than a scan line, do not stare into the beam or attempt to repair the unit. Discontinue operation and return the unit to your dealer. Note that when using Marker Beam Mode, a single aiming dot is projected momentarily preceding a scan line and is not considered a malfunction.



CAUTION

Do not open or otherwise service any components in the optics cavity. Opening or servicing any part of the optics cavity by unauthorized personnel may violate laser safety regulations. The optics system is a factory only repair item.



NOTE

The PowerScan™ RF scanner is required to be used in conjunction with the PSC Base Station, Model: PowerScan RF Base Station.

Radio Frequency Interference

This device complies with Part 15 of the FCC Rules. Operation is subject to the following two conditions:

1. This device may not cause harmful interference, and
2. This device must accept any interference received, including interference that may cause undesired operation.

This Class A digital apparatus complies with Canadian ICES-003.

Cet appareil numérique de la classe A est conforme à la norme NMB-003 du Canada.

This equipment has been tested and found to comply with the limits for a Class B digital device, pursuant to Part 15 of the FCC Rules. These limits are designed to provide reasonable protection against harmful interference in a residential installation. This equipment generates, uses and can radiate radio frequency energy and, if not installed and used in accordance with these instructions, may cause harmful interference to radio communications. However, there is no guarantee that interference will not occur in a particular installation. If this equipment does cause harmful interference to radio or television reception, which can be determined by turning the equipment off and on, the user is encouraged to try to correct the interference by one or more of the following measures:

- Reorient or relocate the receiving antenna.
- Increase the separation between the equipment and receiver.
- Connect the equipment into an outlet on a circuit different from that to which the receiver is connected.
- Consult the dealer or an experienced radio/TV technician for help.

Maintenance

The scan window will require occasional cleaning to remove smudges, dust and other debris. To ensure optimal performance, clean the Scan Window using a soft cloth or lens tissue dampened with isopropyl alcohol (or equivalent). See Figure 12. The scanner body can also be cleaned using this method.

Figure 12. Cleaning the Scan Window

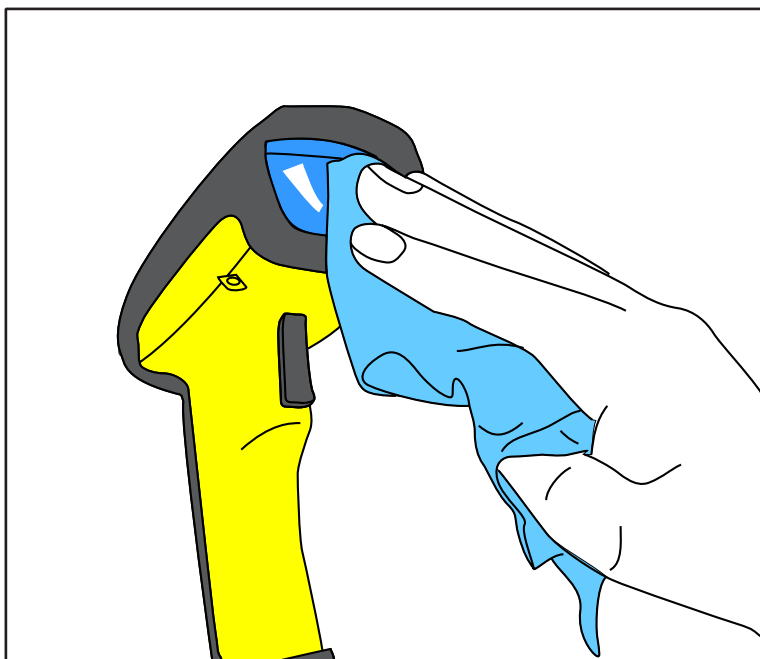

Troubleshooting

Troubleshoot your RF scanning system by performing the following checks:

For the RF system, ensure that...

- the battery is charged. See *Battery Charging and Maintenance* on page 7.
- the battery is properly installed. See *Installing the Battery* on page 2.
- the scanner is linked to the desired Base Station. See *Linking the Scanner to a Base Station* on page 5.
- the scanner is within reasonable operating range of the Base Station, with no major obstructions between the radio units such as thick walls or heavy machinery. (At the time of this writing, maximum line-of-sight range is specified at 150 feet.)
- there is no local signal interference with other radio-operated equipment. Consult the Systems Manual concerning selection of alternate channels.
- the Base Station is powered-on. You can verify the Base Station's AC Adapter by using a known-good AC Adapter.
- the Base Station interface cable is securely attached to the host. Consult your technical support manager or refer to your host system manual to identify the proper cable connection for the scanner. If necessary, verify interface cable function by using a known-good interface cable.

If the problem is specific to scanning, verify that...

- the bar codes you are trying to scan are of satisfactory quality. Bar code label verifiers are available from your dealer if you need precise reporting of label details. Bar codes that are damaged (wrinkled, smudged, or torn) may cause the scanner to read poorly or not at all. If bar code quality seems to be the problem, check to see if the scanner will read a sample bar code from the following pages.
- the programmable setting for advanced Quadralogic II™ decoding is set optimally for your system. (See *Enhanced Scanning for Hard-to-Read Bar Codes* on page 19.)

Sample Bar Codes

Use these test bar codes to check the scanner's ability to read the various symbologies represented.

Code 128



Code 39



Interleaved 2 of 5



Standard 2 of 5



Codabar



Code 93



MSI/Plessey



UPC-A



UPC-A with 2 digit Add-on



UPC-A with 5 digit Add-on



UPC-E



EAN-8



EAN-13



DECLARATION OF CONFORMITY

PSC hereby declares that the Equipment specified below has been tested and found compliant to the following Directives and Standards:

Directives: EMC 89/336/EEC
Low Voltage 73/23/EEC
R & TTE 1999/5/EC

Standards: ETS 300 683:1997 ETS 300 220-3:2000
EN60825-1:1996 EN60950:1997

Equipment

Type: Bar Code Scanning Equipment

Product: PowerScan™ RF Bar Code Scanner



Charles W. Vanlue
Director, Corporate Quality
PSC, Inc.
959 Terry Street
Eugene, OR 97402
U.S.A.



Nigel Davis
Vice President
Europe, Middle East & Africa
PSC Bar Code Ltd.
Axis 3, Rhodes Way
Watford, England
WD24YW
UK



Asia Pacific

PSC Hong Kong
Hong Kong
Telephone: [852]-2-584-6210
Fax: [852]-2-521-0291

Australia

PSC Asia Pacific Pty Ltd.
North Ryde, Australia
Telephone: [61] 0 (2) 9878 8999
Fax: [61] 0 (2) 9878 8688

France

PSC S.A.R.L.
LES ULIS Cedex, France
Telephone: [33].01.64.86.71.00
Fax: [33].01.64 46.72.44

Germany

PSC GmbH
Darmstadt, Germany
Telephone: 49 (0) 61 51/93 58-0
Fax: 49 (0) 61 51/93 58 58

**Corporate
Headquarters**

PSC Inc.
Portland, OR
Telephone: (503) 534-3553
Fax: (503) 534-3555

Italy

PSC S.p.A.
Vimercate (MI), Italy
Telephone: [39] (0) 39/62903.1
Fax: [39] (0) 39/685496

Japan

PSC Japan K.K.
Shinagawa-ku, Tokyo, Japan
Telephone: 81 (0)3 3491 6761
Fax: 81 (0)3 3491 6656

Latin America

PSC S.A., INC.
Miami, Florida, USA
Telephone: (305) 539-0111
Fax: (305) 539-0206

United Kingdom

PSC Bar Code Ltd.
Watford, England
Telephone: 44 (0) 1923 809500
Fax: 44 (0) 1923 809 505

PSC Inc.

959 Terry Street
Eugene, OR
Telephone: (541) 683-5700
Fax: (541) 686-1702



www.pscnet.com



Printed on recycled paper

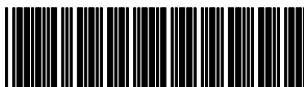

Free Manuals Download Website

<http://myh66.com>

<http://usermanuals.us>

<http://www.somanuals.com>

<http://www.4manuals.cc>

<http://www.manual-lib.com>

<http://www.404manual.com>

<http://www.luxmanual.com>

<http://aubethermostatmanual.com>

Golf course search by state

<http://golfingnear.com>

Email search by domain

<http://emailbydomain.com>

Auto manuals search

<http://auto.somanuals.com>

TV manuals search

<http://tv.somanuals.com>