

PLPSMR9 Parking sensor system

PLPSMR9 consists of ultrasonic sensors, camera, TFT monitor integrated into rear mirror, control box. This system detects the distance between the car and the back obstruction with the ultrasonic sensors installed at the rear bumper of the car, the TFT monitor will display the distance in number and show the back view as well.

Main features

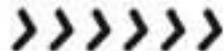

- Real mirror with 3.5 inch TFT LCD display
- Colorful TFT monitor to show back view
- Numeric distance display and direction indicator in three colors
- System sound "DANG DANG"
- 2or 4 Sensor optional select
- Stick-on or insert-in type sensors for optional select
- Rear mirror size: 268x90x45mm

Connection diagram >>>>>>

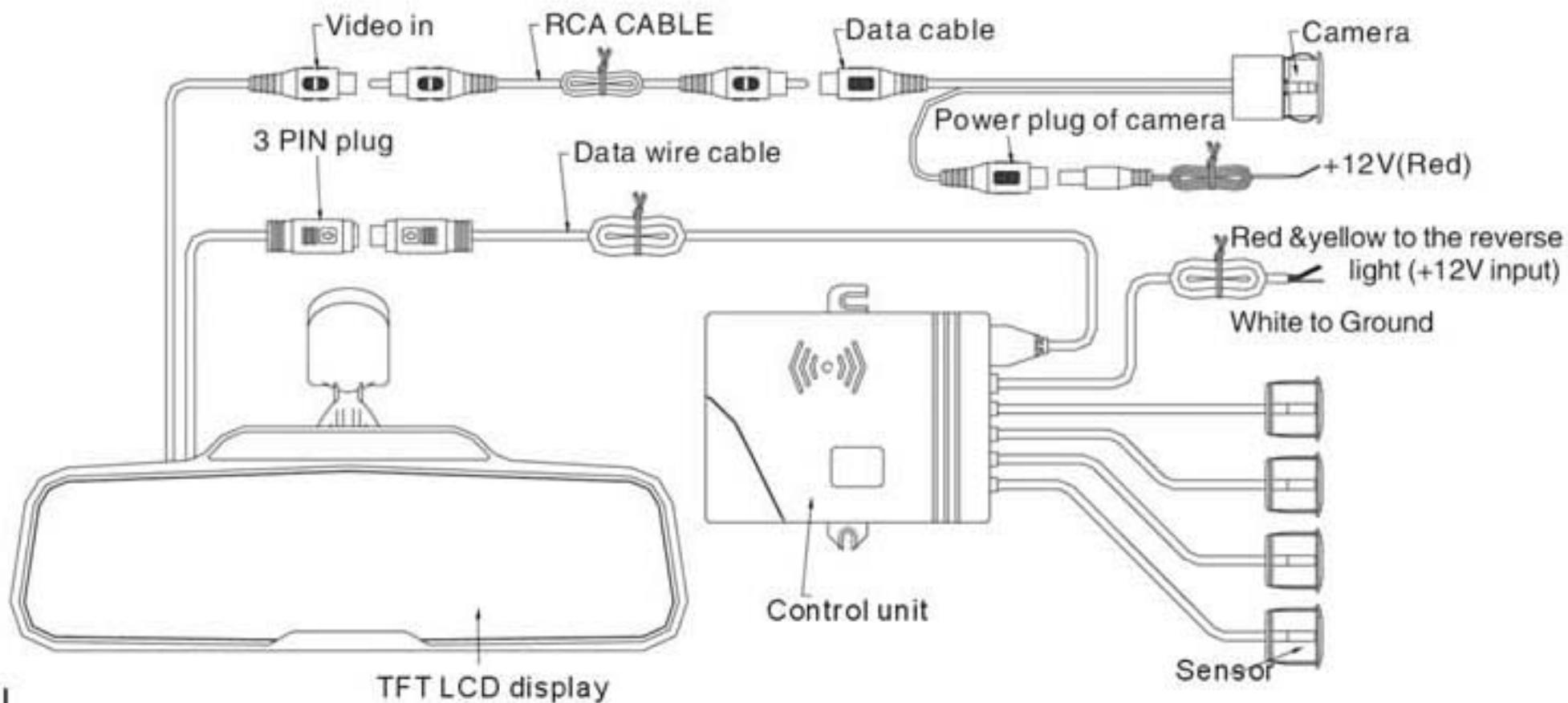

Specifications

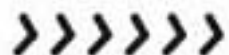

- Rated voltage: 12V
- Operation voltage range: 10.5V~16VDC
- rated current: 200mA~600mA
- Detection distance: 0.2~1.5m
- Ultrasonic frequency: 40KHz
- Working temperature of control box: -30°C ~ $+80^{\circ}\text{C}$
- Working temperature of display: 0 ~ $+60^{\circ}\text{C}$

Detecting Range

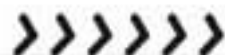

Top View

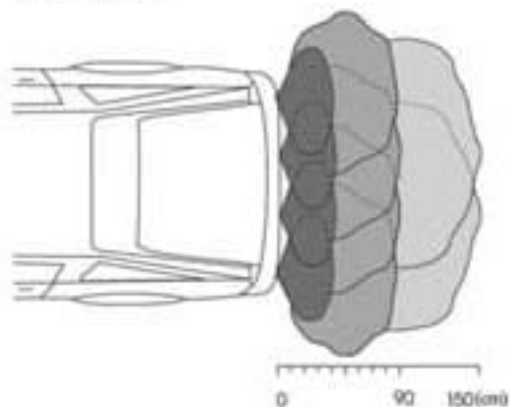

Side View

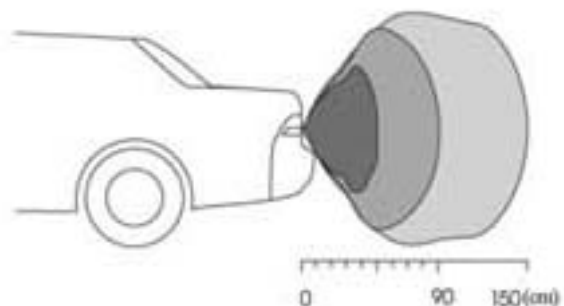

View angle of Camera

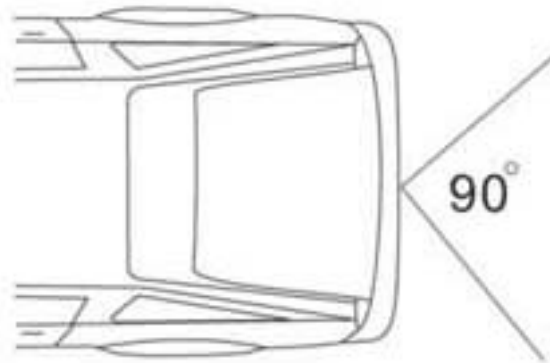
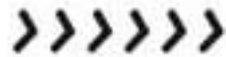

Camera90°

Alarm mode

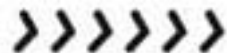

| Stages | Distance | Awareness | Alarm sound | Number | Color | Bars |
|--------|-------------|----------------|--------------------|-----------|----------|---------|
| 1 | 150cm above | Safe Area | Silence | No Number | No color | No bars |
| 2 | 100~150cm | Safe Area | Dang.....Dang..... | 10~1.5 | Green | 1 to 5 |
| 3 | 100~90cm | Alert Area | Dang...Dang... | 0.5~0.9 | Yellow | 6 to 9 |
| 4 | 0~40cm | Dangerous Area | DangDangDang | 0.0~0.4 | Red | 10 |

Display status

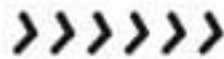

Safe Area 100-150cm

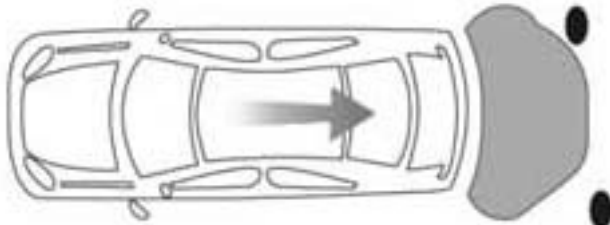

Alert Area 50-90cm

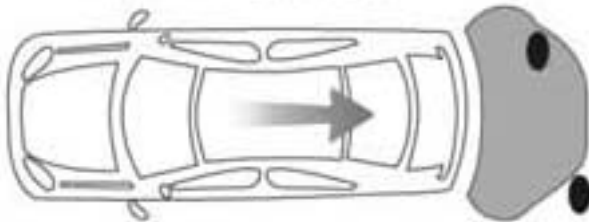

Dangerous Area 0-40cm

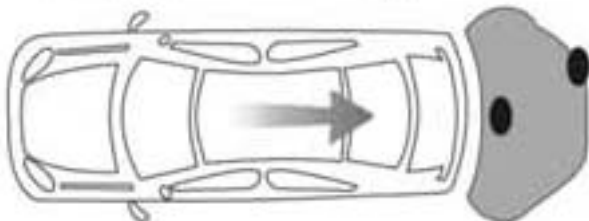

Green Number



Orange Number



Red Number



Display status

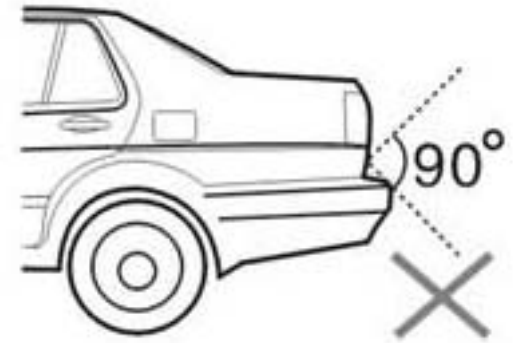
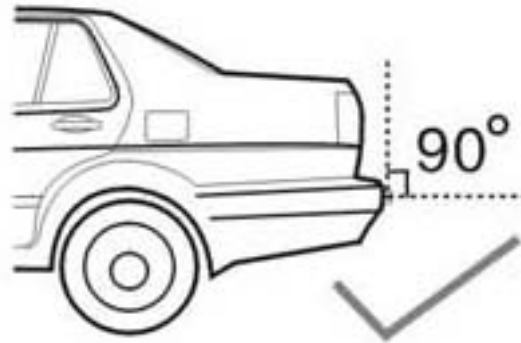
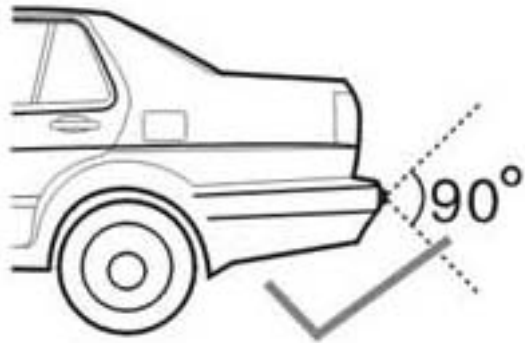
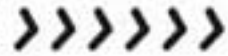

Be sure no other parts of the vehicle falls into the detecting range of the sensors so as to give a wrong detection

Advised position to install the sensors

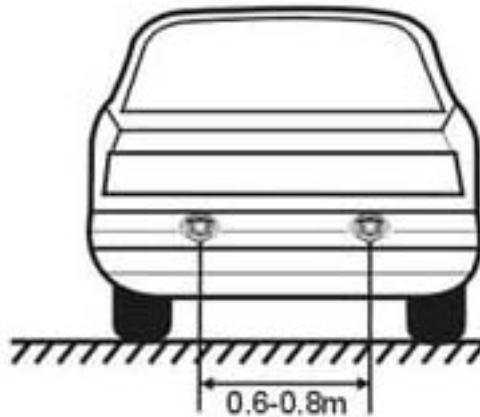

Install 2 sensors

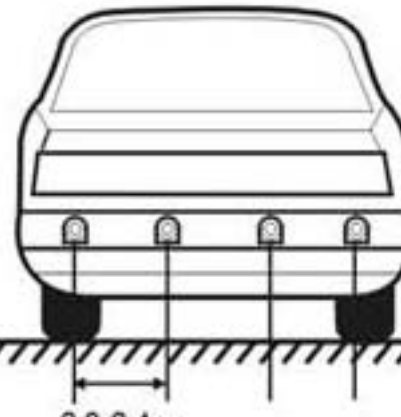

0.3-0.4m
Install 4 sensors

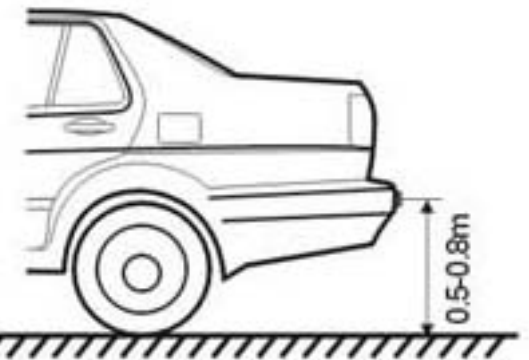

Install the insert-in sensor

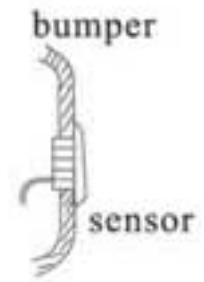
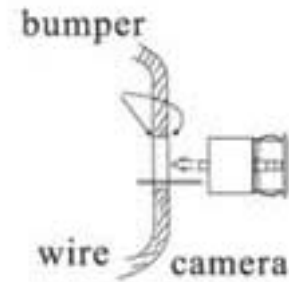
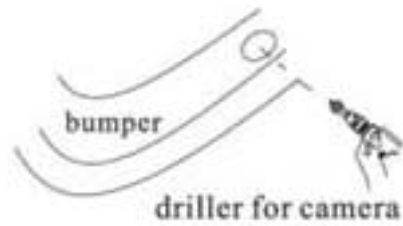
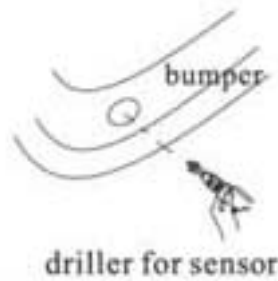

The direction of sensors

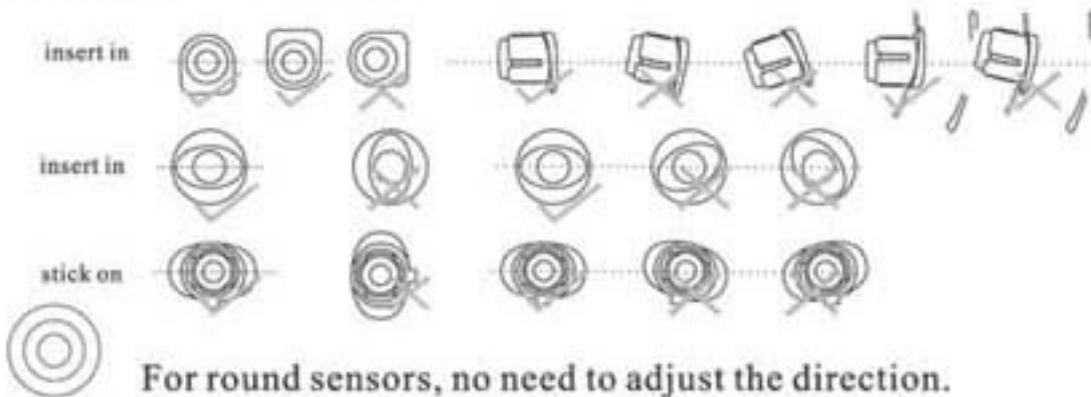

Note:

1. Adjust the direction of the sensors to avoid wrong detection; for round sensors, no need to adjust the direction
2. Camera: The side with arrow in the plastic case should be at the upper position.

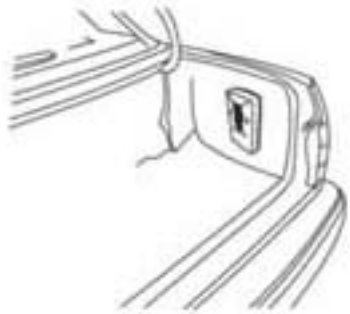

The power unit is mounted inside the vehicle near the back.



make sure the unit is installed in a clean and dry place, away from water and moisture.

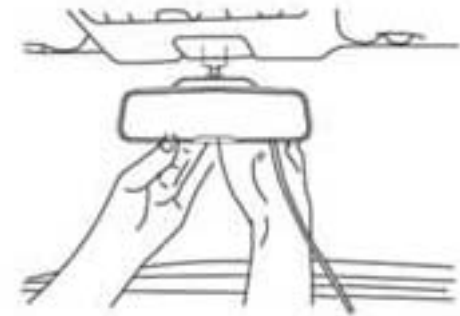

Stick the rear mirror onto the windscreen

Objects may cause failure detection

Smooth slope

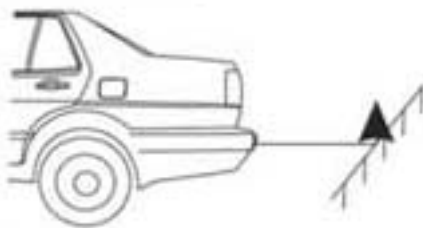

Smooth round object

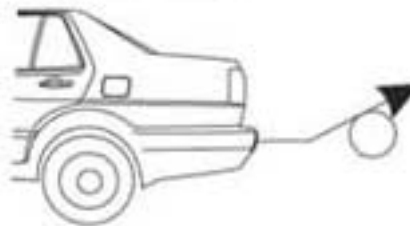

Objects absorbing wave, e.g. Cotton

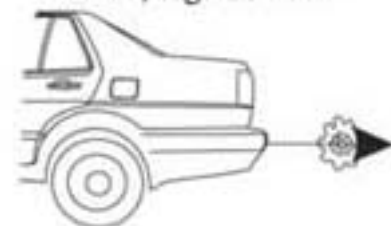

TROUBLE SHOOTING

| TROUBLE | SHOOT |
|---|--|
| No power/No display | <ul style="list-style-type: none">✧ Check power input wires✧ Check fuse✧ Check connection between control unit and display unit |
| ONE or TWO Sensor no respond or sensitive low | <ul style="list-style-type: none">✧ Check connection between power unit and sensors✧ Plug out all sensors and plug in individually to find out the defective sensors. |
| Display alway same reading | <ul style="list-style-type: none">✧ Reset power input (shift again revere gear)✧ Plug out all sensors and plug individually to find the defective display same reading |
| No image at TFT LCD Display | <ul style="list-style-type: none">✧ Check the RCA cable between camera and TFT LCD display✧ Check power input wires for camera✧ Check data cable between main unit and TFT LCD display |

Free Manuals Download Website

<http://myh66.com>

<http://usermanuals.us>

<http://www.somanuals.com>

<http://www.4manuals.cc>

<http://www.manual-lib.com>

<http://www.404manual.com>

<http://www.luxmanual.com>

<http://aubethermostatmanual.com>

Golf course search by state

<http://golfingnear.com>

Email search by domain

<http://emailbydomain.com>

Auto manuals search

<http://auto.somanuals.com>

TV manuals search

<http://tv.somanuals.com>