

PYLE

Multi Media Mobile Audio System

PLCD88USMP

OPERATIONAL MANUAL



FM/AM

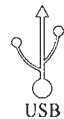

USB

Welcome!

Thank you for purchasing this compact disc car audio system!
To operate the unit correctly, please read the owner's manual carefully before using the unit. Keep these instructions and retain this booklet for future reference.

CONTENTS

Notes on Installation	4
Precautions.....	5
Wiring Connection	6
Location of Control	7
Card Remote Control	8
Basic Operation	9
Radio Operation.....	13
CD/MP3/USB Player Operation	16
Maintenance	21
Install & Detach the Unit.....	22
Specification.....	24
Simple Troubleshooting Guide.....	25

Notes on Installation

- ★ *The unit is designed for 12V DC, negative ground operation system only. Before installing the unit, make sure your vehicle is connected to DC 12V negative ground system.*
- ★ *Be sure to connect the color coded leads according to the diagram. Incorrect connections may cause the unit to malfunction or damage the vehicle's electrical system.*
- ★ *Be sure to connect the speaker (-) leads to the speaker (-) terminal. Never connect the left and right channel speaker cables each other or to the vehicle body.*
- ★ *Make sure all the connections are completely correct before turning on your unit.*
- ★ *When replacing the fuse(s), the replacement must be of the same amperage as shown on the fuse holder.*
- ★ *Do not block vents or radiator panels. Blocking them will cause heat to build up inside and may result in fire.*
- ★ *After completing the installation and beginning to play the unit, (including replacing the battery), please remove the front panel at first, and then press **RES** button with pointed object (such as ball-point pen) to set the unit to initial status.*

Simple Troubleshooting Guide

Problem	Cause/Solution
No power.	★ Check and make sure whether the fuse is blown, replace with the proper value if necessary.
Some errors occur in the LCD or no function when pressing the button.	★ Press the RESET button.
Unable to receive stations.	★ Check and make sure whether the antenna is inserted or the antenna is properly connected, if not, insert the antenna or connect it properly.
Poor effect when receiving a station.	<ul style="list-style-type: none"> ★ Antenna may not be the proper length. Make sure the antenna is fully extended or broken; if broken, replace the antenna with a new one. ★ The antenna is poorly grounded, check and make sure the antenna is properly grounded at its mounting location.
CDs cannot be loaded.	★ A CD is loaded in the mechanism.
Sound skips.	★ The CD is dirty or damaged.

Note!

If any of the problem persist after check list had been made, consult your nearest service dealer. Never attempt to disassemble your unit by yourself.

Specifications

General

Power Requirement	14.4V DC (11-16V allowable)
Load Impedance	4Ω
Max. Power Output	60W x 4
Tone Controls	±8dB Bass 100Hz Treble 10KHz
Dimensions	Approx. 192 x 178 x 50 mm (d/w/h)
Mounting Dimensions	Approx. 169 x 182 x 53 mm (d/w/h)
Weight	Approx. 1.75kg

FM Section

Frequency Range	87.5-107.9(MHz) (America)
IF	10.7MHz
Usable Sensitivity	15dBuV (-30dB)
Singal-to-noise Ratio	50dB
Stereo Separation	30dB (1KHz)
Frequency Response	30-15000Hz

AM Tuner Section

Frequency Range	530-1710(KHz) (America)
IF	450KHz
Usable Sensitivity	28dBuV (-20dB)

CD/USB Player Section



Singal-to-noise Ratio	65dB
Separation	60dB(1KHz)
Distortion	0.5%

Note!

Due to continuous product improvement, specifications and design are subject to change without prior notice.

Precautions

★ *This unit can play the following discs only:*

Type of disc	Label on the disc	Recorded material	Size of disc
CD		Sound only	12cm
MP3		Sound only	12cm
USB		Sound only	Version 2.0 and less

★ *Do not attempt to modify the unit, modifying the unit may cause an accident.*

★ *Stop the vehicle before carrying out any operation that could interfere with your driving.*

★ *Do not work in extremely high or low temperature. Be sure the temperature inside the vehicle is between -10° C and +60° C before turning on your unit .*

★ *To enjoy optimum sound and images while playing, handle the discs as follows:*

——Handle the disc by its edge to keep the disc clean, and do not touch the surface.



——Do not use your CDs with paste residue or ink attached.



——Do not use CDs with labels or stickers attached, which may leave a sticky residue while beginning to peel off. (Shown as the picture)

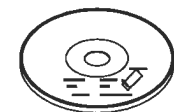

——Clean the discs with an optional cleaning cloth. Wipe each disc from the center out. (Shown as the picture)

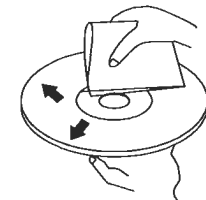

Wiring Connection

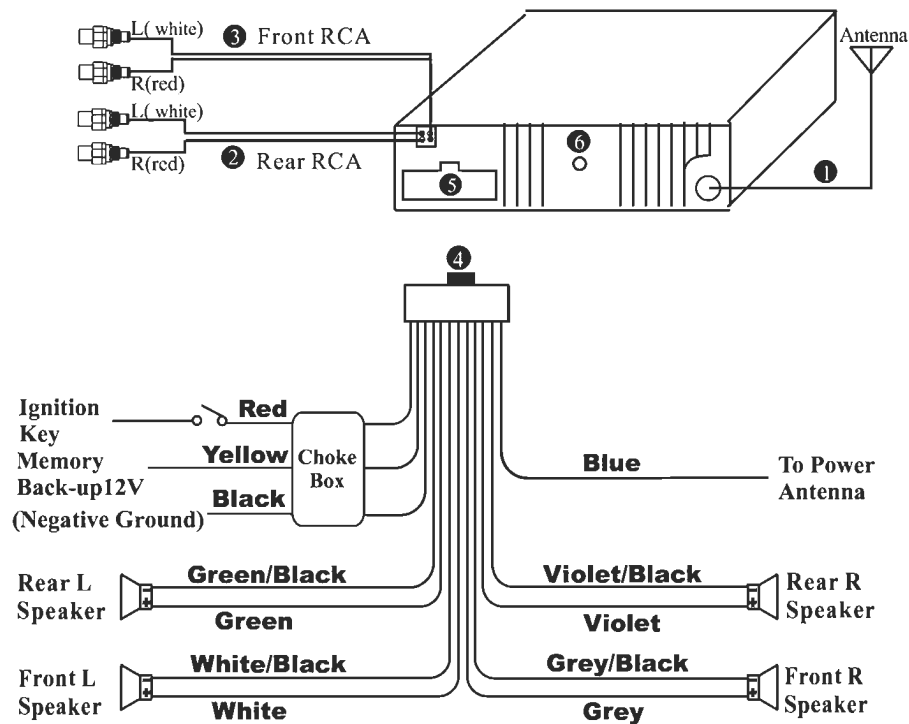

- | | |
|----------------------|--------------------------|
| ① Antenna Receptacle | ④ Output Plug (male) |
| ② Rear RCA | ⑤ Output Socket (female) |
| ③ Front RCA | ⑥ Screw Holes |

Install/ Detach the Unit

Installation Method ②

Installation using the screw holes at the sides of the unit.

1. Remove the hooks on both sides.
2. Select a position where the screw holes of the mounting bracket supplied with the car and the screw holes of the main unit become aligned (are fitted), and tighten the screws (see ④ at 2 places on each side). And then fasten them to the car.

NOTE: Outer Trim Frame ⑤ Hook ⑨ and Mounting Sleeve ① are not used for installation method ②

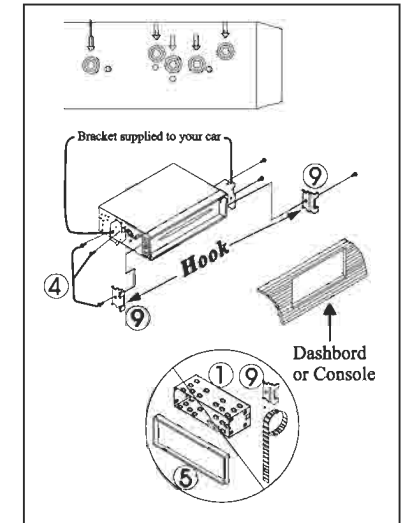

Detach the Unit (For Installation Method ①)

1. Remove the outer trim frame.

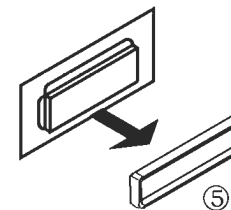



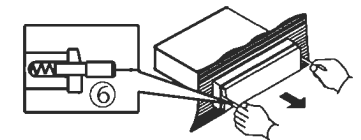



2. Insert the keys supplied with the unit at both sides of the unit as shown in figure until they click. Pulling the keys makes it possible to remove the unit from the dashboard.

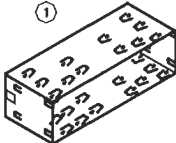

Installation

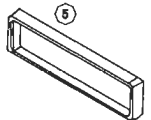
Parts List

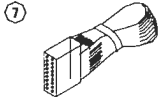
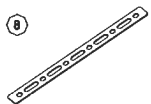
			
Mounting Sleeve x1	Rear Mounting Bolt x1	Harness Rubber x1	M5 x 5 4 Screws
			
Outer Trim Frame x1	Key x2	Connecting Wire x1	Metal Lath x1

Installation Method ①: DIN Front-Mount

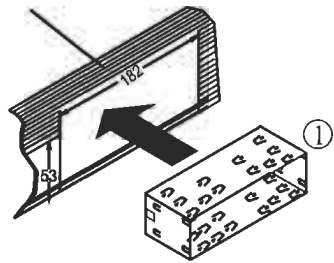
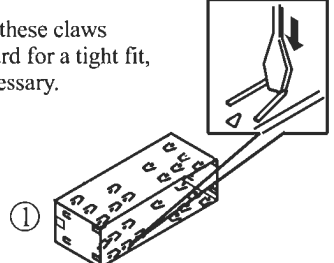
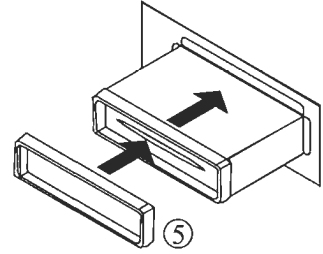
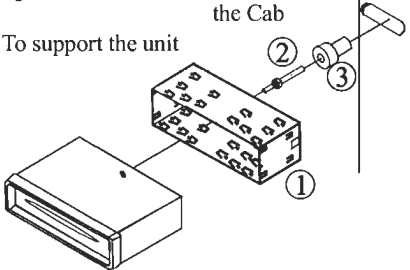
 <p>1</p>	 <p>2</p> <p>Bend these claws outward for a tight fit, if necessary.</p>
 <p>3</p>	 <p>4</p> <p>To support the unit</p> <p>Front Wall of the Cab</p>

Location of the Control

Front Panel

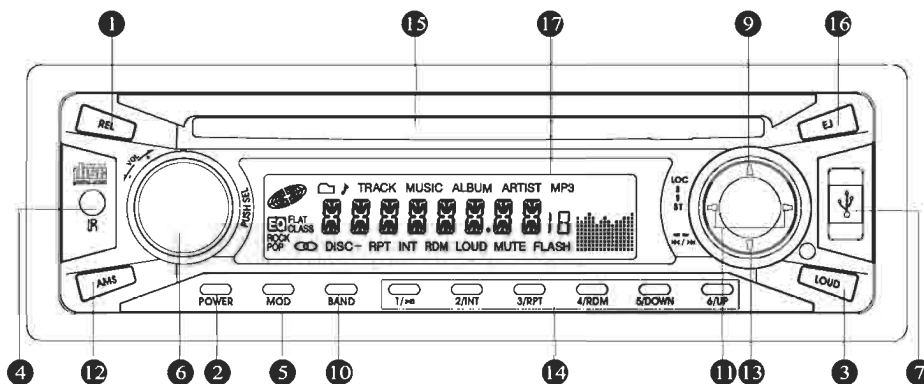

Base



- | | |
|--|--|
| <ul style="list-style-type: none"> ① REL(Release Button) ② Power Button ③ Turning Loudness On/Off ④ Remote Control Receptor ⑤ Mode Switch ⑥ Volume Control/Setting the Characteristics ⑦ Mute Button ⑧ Reset Button ⑨ LOC | <ul style="list-style-type: none"> ⑩ Band Selector ⑪ Tuning/Selecting Tracks ⑫ Scanning/Memorizing Stations Automatically ⑬ ST ⑭ Number Buttons ⑮ CD Slot ⑯ Eject Button ⑰ LCD Display |
|--|--|

Card Remote Control

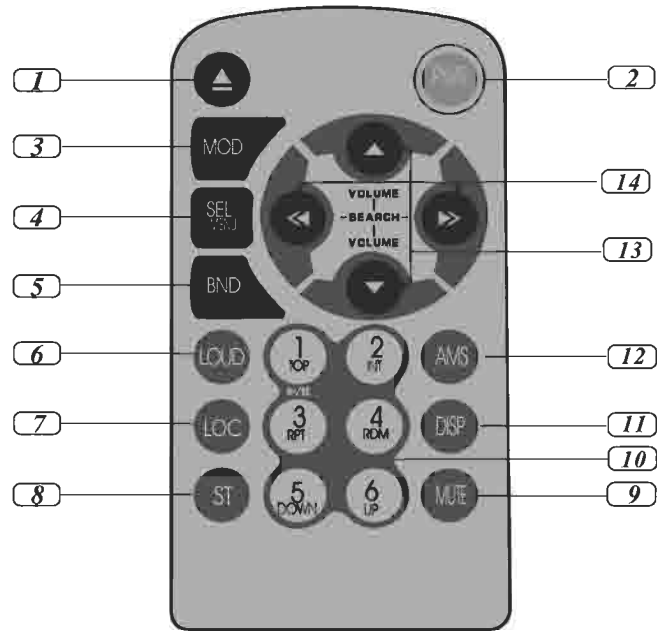

- | | |
|----------------------------|---|
| ① Eject Button | ⑧ L/R Selector or Enter |
| ② Power Button | ⑨ Mute Button |
| ③ Mode Switch | ⑩ Number Buttons |
| ④ Setting Characteristics | ⑪ Displaying and Adjusting Time |
| ⑤ Band Selector | ⑫ Scanning /Memorizing Stations Automatically |
| ⑥ Loudness Button | ⑬ Volume Control |
| ⑦ DX/LOC Selector or Enter | ⑭ Tuning /Selecting Tracks |

Maintenance

Replacing the Fuse

Make sure the amperage match the specified when replacing the fuses. If the fuse is blown, check the power connection and replace a new one. If the same problem occurs, it would be subjected to the malfunction in-house. In such cases, please consult the nearest service dealer nearest

Warning

Never use the fuse with the rated amperage more than that supplied to your unit, otherwise it will damage the unit.

Replacing the Battery

When the range of the operation of the card remote control becomes short or no functions while operating. Replace the lithium battery with a new button cell (CR2025). Make sure the battery polarity before replace.

1. Gently pull out the Battery Holder while pressing the Stopper ①

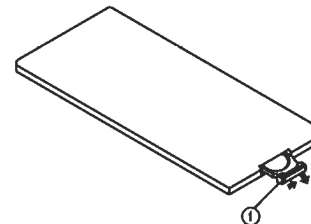

2. Put the button-type battery with mark(+) upward into the Battery Holder.

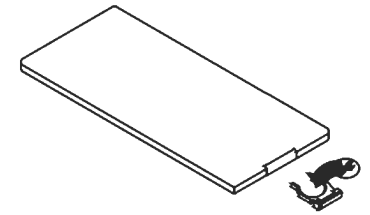

3. Insert the Battery Holder into the Remote Control.

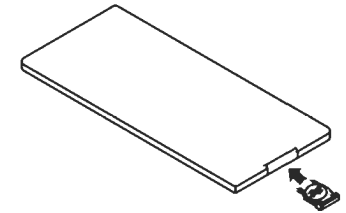

Precautions on Using Lithium Battery

- Always keep the lithium battery beyond children's reach. In case swallowed, see a doctor immediately.
- Cleaning the battery with a dry cloth, to ensure its perfect connected.
- Make sure the proper polarity when loading with the battery.
- To prevent short circuit, do not use metal tweezers to clip the battery.

Warning!

Improperly handle the battery may result in hazardous exploded. It cannot be charged, disassembled or thrown into fire.

9. Ejecting Disc

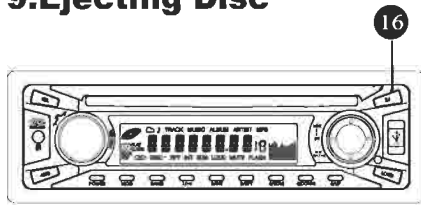

Pressing **16** ▲ button can eject the disc, **LCD** shows “**EJECT**” . If the disc is not taken away in 10s after **CD Slot** is out, it will enter into the unit automatically.

Note:

- * Pressing **REL** button on the card remote control performs the same function.

10. Exit a USB

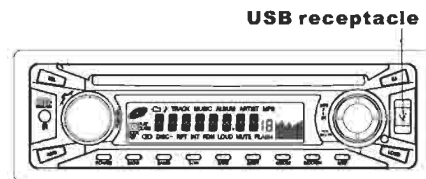

During USB mode, the main unit would switch to TUNER mode directly when exit USB.

During CD,MP3 or TUNER mode, the main unit will keep the previous mode when exit the USB.

Note:

- * fill in the rubber plug after take out the USB.

11. Release Button

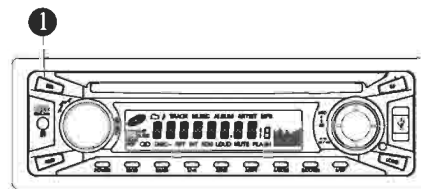

Pressing the **1** (**REL**) button can release the front panel.

Note:

- * This function can only be operated on the head unit.

Basic Operation

1. Reset the Unit

When operating the unit the first time or after replacing the car battery, you must reset the unit.

Press **8** (**RES**) button on the base with a pointed object, (such as a ball-point pen) to set the unit to initial status.

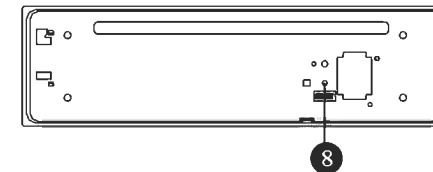

Note:

- * When some errors occur on the display, you can also press **RES** button to resume to normal, and it will erase the clock setting and some memorized function.
- * This function can only be operated on the head unit.

2. Sensor

Infrared Sensor

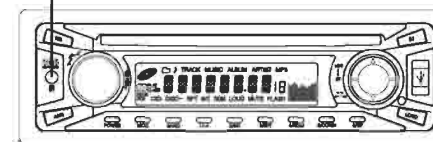

Infrared Sensor:

Receptor for the card remote commander. (Show as picture)

3. Turn the Unit On/Off

Press **2** (**POWER**) button to turn on the unit, press it again, the unit is still in waiting status. When insert a disc, the unit will automatically start playing. Keep pressing to turn off the unit completely.

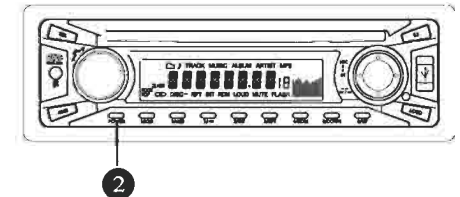

Note:

- * Pressing **2** **PWR** button on the card remote control performs the same operation.
- * When the unit is off, pressing any button (except **1** **REL** button and **16** **EJC** button) can turn on the unit.
- * When the unit is in waiting status, the inserted disc will be played automatically

4. Mute Function

Press **9** **MUTE** on the remote control to cut down sound output, “**MUTE ON**” appears on the LCD. Press it again to resume to previous volume level.

Note:

- * This function is operated by using the remote control

5.Mode Selector

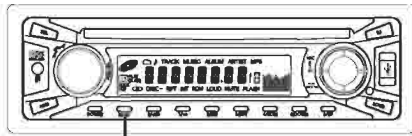

Press **5** (**MOD**) button, mode can be selected as follows:



TUNER is radio mode, **S-CDP** is single disc playback mode, **USB** is USB playback mode.

Note:

* Pressing **3** **MOD** button on the card remote control performs the same operation.

6.Displaying/Adjusting Time

- 1 Press **11** (**DSP**) button of card remote , **LCD** shows present time, and it returns to original status after 5 seconds.
- 2 When time is shown, press and hold **DSP** button until the two numbers begin to blink, then press (**VOL+**) button can adjust hours and press (**VOL-**) clockwise can adjust minutes. It will return to original status if not adjusted in 5 seconds.

Note:

This function is operated by using remote control only.

- 5 Rotate **6** button clockwise, make the first number “0” increase to “1” , then **LCD** will show “131” ;
- 6 Pressing **6** button will play the 131th track.

* File Search

For example:The structure of the tracks in the disc or in the USB is as follows, find the 3.MP3 track in 3 areas through file search.

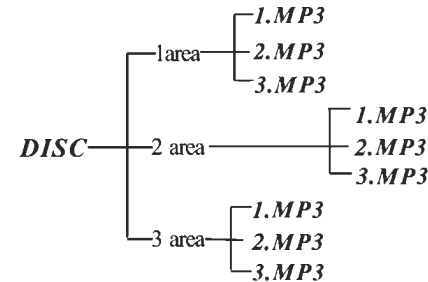

- 1 Press “**AMS**” button twice, **LCD** shows “**FILE SCH**” , press **6** button to enter into file searching mode;
- 2 Now **LCD** shows “**CD 01**” blinking, turn **6** button clockwise until **LCD** shows “**CD 03**” , press **6** button to enter into the 3rd area;
- 3 Now **LCD** shows “**01**” blinking, turn **6** button clockwise until **LCD** shows blinking “**03**” ;
- 4 Press **6** button, track 3.MP3 in 3area will be played.

* Character Search

For example:The structure of the tracks in the disc or in the USB is as follows, find the cd.Mp3 through character search.

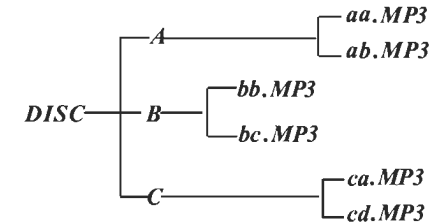

- 1 Press “**AMS**” button three times, **LCD** shows “**CHAR SCH**” , press **6** button to enter into character searching mode.
- 2 Now **LCD** shows blinking “**A**” ,rotate **6** button clockwise until **LCD** shows blinking “**C**” , press **6** button to enter into C files area.
(**Note** : If now press **6** button more than 0.5 seconds, the first track ca.MP3 in the C files area will be played.)
- 3 Now **LCD** shows “**CA**” , “**A**” blinking per 0.5 seconds , rotate **6** button clockwise until **LCD** shows “**CD**” ;
- 4 Press **6** button, track cd.MP3 will be played.

Note:

* In order to predigest instruction, the example only contains several character files; in actual operation, character search will be carried out on the principle above pursuant the sequence of the alphabet.

7. Number Buttons

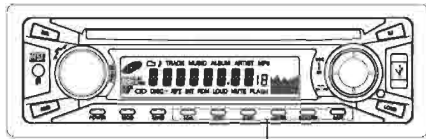

- 1 During playback mode, press and hold “1” button for one second, the first track in the disc will be played.
- 2 During MP3/USB playback mode, pressing “5” button can go backward to the tenth track before the present track, for example: from No.60 track to No.50 track; pressing “6” button can go forward to the tenth track after the present track, for example: from No.60 track to No.70 track.

Note:

- * When operated by the card remote control, pressing the same number buttons on it performs the same function.

8. Searching Tracks

During MP3/USB mode, searching tracks can be achieved through track search, file search and character search by using 6 (SEL) button and 12 (AMS) button.

Note:

- * 4 button and 12 button on the card remote control have the same function as 6 (SEL) and 12 (AMS) separately.

*Track Search

For example: Find the track NO.131 in the disc.

- 1 Press “AMS” button once to enter into initial searching mode, LCD shows “TRK SCH”, then press 6 button, LCD shows “TRK 001”, the third number “1” blinks per 0.5 seconds;
- 2 Press 6 button to select the third number “1”, the second number “0” will blink per 0.5 seconds;
(Note: If press 6 button more than 0.5 seconds, the first track will be played.)
- 3 Rotate 6 button clockwise, make the second number “0” increase to “3”;
- 4 Press 6 button to select the second number “3”, the first number “0” will blink per 0.5 seconds;
(Note: If press 6 button more than 0.5 seconds, the 31th track will be played.)

7. Turning Loudness On/Off

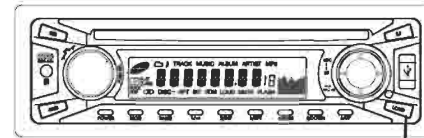

Press 3 button to start the LOUD, which increased the high/low sound. Under the LCD, LOUD appear, press again will turn it off. This function mainly aim at the abtuse audition of human.

Note:

- * Pressing 6 button on the card remote control performs same operation.

8. Volume Control/ Characteristics Setting

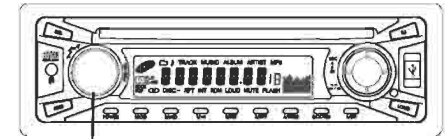

- 1 **Volume Control:** Rotating 6 (VOL) button clockwise can increase volume level and rotating it anti-clockwise can decrease volume level.

Note :

- * Pressing 13 [▲][▼] button on the card remote performs the same operation. Press [▲] to increase volume level and press [▼] button to decrease volume level.

- 2 **Setting Sound Characteristics:**

Repeatedly press 6 (SEL) button to select the desired mode in the following order:



After selecting the desired mode, you can rotate 6 button to select desired status of the current mode.

Note:

- * When operated by the card remote control, press 4 button to selected desired mode; press 13 [▲][▼] button to adjust desired status;
- * If not adjusted in 5 seconds, the unit will get out the adjusting status.

3 Setting Other Characteristics:
Pressing **6** (SEL) button and holding it for 3 seconds will enter into another selected mode as follows:

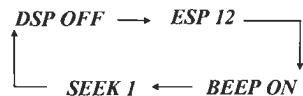

Now repeatedly press **6** button to select the desired mode in the above order. After selecting one mode, you can rotate **6** button to select desired status of the current mode.

* Under **DSP OFF** mode, rotate **6** button, status switches in the following order. When you are listening to popular music, classic music or rock music, selecting relative status can adjust the sound quality perfectly:



* Under **DSP OFF** mode, Bass and Treble mode return to initial settings when P-EQ system is on, “Bass” and “Treble” disappear.

* Under **ESP 12** mode, rotate **6** button, **LCD** shows “**ESP 12**” or “**ESP 45**”, choosing corresponding status can select 12 seconds or 45 seconds when playing CD/MP3.

* Under **BEEP** mode, rotate **6** button, **LCD** shows “**BEEP ON**” or “**BEEP OFF**”, choosing corresponding status can turn on or turn off beep.

* Under **SEEK** mode, rotate **6** button, **LCD** shows “**SEEK 1**” or “**SEEK 2**”, choosing corresponding status can adjust the seeking speed of TA function.

Note:

- * When operated by the card remote control, press and hold **4** button for 3s to enter into the selected mode, then repeatedly press **4** button to select the desired mode. After select one mode, you can press **13** [▲][▼] to select desired status under the mode.
- * If is not adjusted in 5 seconds, the unit will get out the adjusting status.

3. Pausing Playback

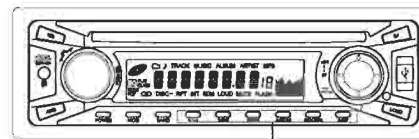

During playback mode, pressing **14** will pause playback. **LCD** shows the elapsed time, and **14** stops running, begins blinking. Press **14** again to revert to normal playback.

Note:

- * Pressing “**1**” button of **10** on the card remote control performs same operation.

4. Scanning Tracks Automatically

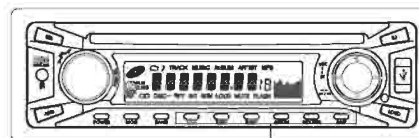

During playback mode, press **14** (**INT**) button to play the first 10 seconds of each track on the disc, and the display shows **INT**, track number and the elapsed time. Press it again to revert to normal playing.

- * When you hear your favorite track, press “**INT**” to stop scanning and start to play the track.

Note:

- * Pressing “**2**” button of **10** on the card remote control performs the same function.

5. Repeat Playing

Press **14** (**RPT**) to perform replaying function when you need to replaying the track you like.

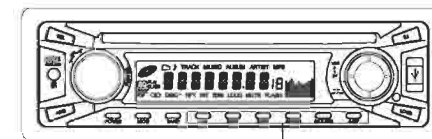

Press **14** (**RPT**) button to repeat the current track being played. “**RPT**” appears on the **LCD**, which indicates replaying one track. Press it again to shut down this function.

Note:

- * Pressing “**RPT**” button of **10** on the card remote control performs the same function.
- * The Default setting is **Repeat all tracks**.

6. Playing Tracks in Random Order

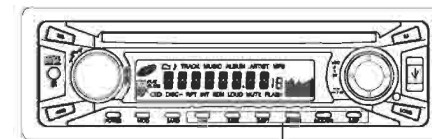

During playback mode, when pressing **14** (**RDM**) button, “**RDM**” will appear on the **LCD**, the unit plays any track at random. Press **RDM** button again to return to normal playing from the first track, **LCD** does not show **RDM**.

Note:

- * Pressing “**4**” button of **10** on the card remote control performs the same function.

CD/MP3/USB Operation

1. Playing CDs

While playing CD、MP3 discs, insert a CDs (with labeled side up) into ⑬ (Disc Loading Slot)(shown as picture), the mechanism will automatically switch on. If a CDs is loaded, press ⑤ (MODE) button to start playing.

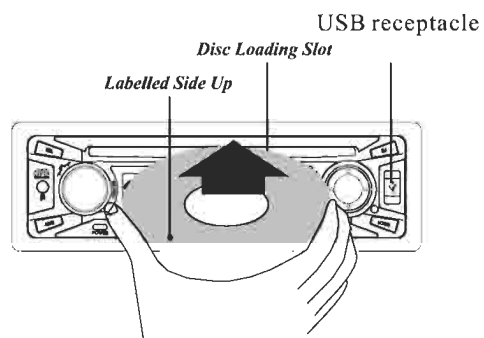

When playing USB, firstly unstop the rubber plug, then insert USB in USB receptacle, the mechanism will automatically play. If USB have been inserted, press (MODE) to switch to USB playing mode.

Note:

* the **USB** must contain music files of CD,MP3.

2. Selecting Tracks

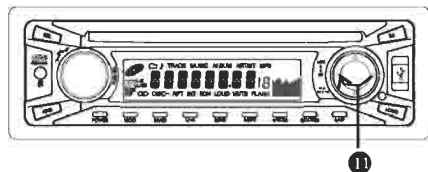

During playback mode, you can choose your favorite track by pressing ⑪ (▶▶) or (◀◀) button upward or downward respectively. Press and hold ⑪ (▶▶) or (◀◀) button to play the track fast upward or downward.

Note:

* Pressing ⑭ (◀▶) button on the card remote control performs the same operation.

Radio Operation

1. Band Selector

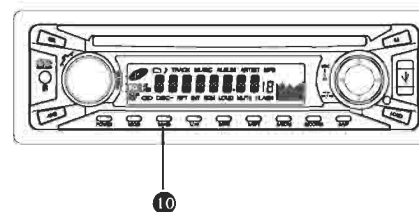

During radio mode, repeatedly press ⑩ (BAND) button to select bands in the following order:

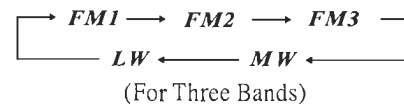
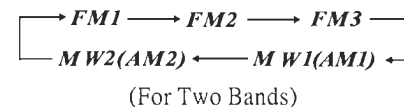

Note:

* Pressing ⑤ **BND** button on the card remote control performs the same operation.

2. Manual/Automatically Tuning

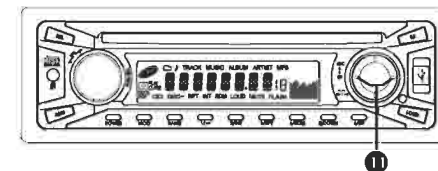

① **Manual Tuning:** Press ⑪ button continuously to select a station downward or upward respectively.

② **Automatically Tuning:** Press and hold ⑪ button for more than 2 seconds, the radio automatically searches stations downward or upward respectively and plays when it finds a station.

Note:

* Pressing ⑭ (◀▶) on the card remote control performs the same operation.

3.Scanning/Memorizing Stations Automatically

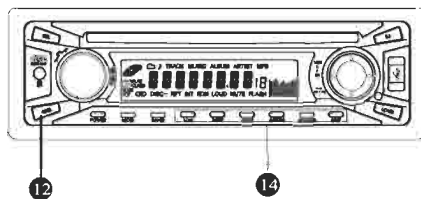

Press **12** (**AMS**) button to scan each stored station 5 seconds respectively which were stored in **14** **Number Buttons**. You can press corresponding number buttons or **12** button when your desired station is charged, the station will be played.

When pressing and hold **12** (**AMS**) button for more than 2 seconds, it will activate automatically memory storing function. The radio will automatically select stations and store them in **14** **Number Buttons**.

Note:

- * Pressing **12** **AMS** button on the card remote control performs the same operation.
- * The unit can be stored up to 6 stations for each band.
- * Regarding the function of Number Buttons, refer to **4.Number Buttons** for more information.

4.Number Buttons

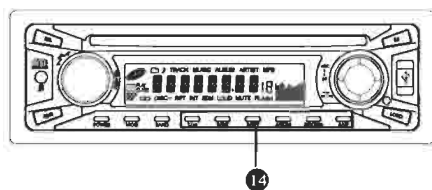

1 **Listen to the radio:** Under radio mode, press **(1-6) Number Buttons** to listen to the stations stored.

2 **Memorizing Stations:** You can store your favourite stations by using **Number Buttons**. You can follow the steps as following:

- * When receiving a station through **11** (▶▶ or ◀◀) button, press and hold one of the number buttons until **LCD** shows the number, which indicates that station is already stored in the corresponding number button.
- * Pressing **12** (**AMS**) button can scan stations and store them in the **(1-6) Number Buttons** automatically.
- * When you are listening to a station stored in a number button, pressing and holding another number button for more than 2 seconds can store the station into another number button at the same time.

Note:

- * Pressing **10** **Number Buttons** button on the card remote control performs the same operation.

5.MO/ST Selector

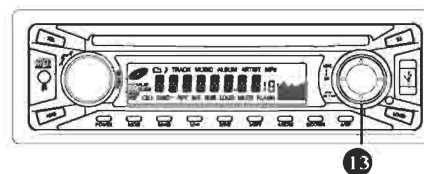

During radio mode, you can press **13** (**ST**) button on the remote control to select **MONO** mode or **STEREO** mode. **STEREO** appear in display, indicates receiving stereo program, **13** indicates radio reception, **MONO** indicates the current status is mono mode.

Note:

- * Pressing **13** button on the card remote control performs the same operation.
- * the unit will turn to the previous mode after 5 seconds no response.

6.Long/short distance Selector

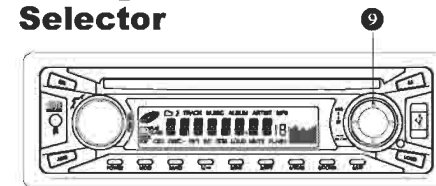

Press **9** (**LOC**) button to receive signal. If **LOCAL** appear in **LCD** display, means receiving the local broadcasting station only, if **DX**, indicates that both local and long distance broadcasting station can be received.

Note:

- * Pressing **7** button on the card remote control performs the same operation.
- * This function is also valid during playback mode.

Free Manuals Download Website

<http://myh66.com>

<http://usermanuals.us>

<http://www.somanuals.com>

<http://www.4manuals.cc>

<http://www.manual-lib.com>

<http://www.404manual.com>

<http://www.luxmanual.com>

<http://aubethermostatmanual.com>

Golf course search by state

<http://golfingnear.com>

Email search by domain

<http://emailbydomain.com>

Auto manuals search

<http://auto.somanuals.com>

TV manuals search

<http://tv.somanuals.com>