

**PYLE**<sup>®</sup>  
**view**

## Operating Instructions

### PLRD195IF



19" Flip Down Monitor w/Built In DVD/SD/USB player with  
Wireless FM Modulator/ IR Transmitter

## Specifications

### Contents

Caution. . . . .	1
Check Point. . . . .	2
<b>Name and Function of Each Part</b>	
Unit. . . . .	3
Remote Control. . . . .	4
Remote Control. . . . .	5
<b>Picture control</b>	
Picture Selections. . . . .	6
<b>Playing a Disc</b>	
Play DVD Player. . . . .	6
<b>Basic Operation</b>	
FM Channel. . . . .	6
<b>DVD Setup</b>	
System setting. . . . .	7
Language Setting. . . . .	8-9
<b>DVD Function</b>	
Playback Function. . . . .	10-11
Advanced Function. . . . .	12
USB/SD card Function. . . . .	12
<b>Installation</b> . . . . .	13
<b>Connect Diagram</b> . . . . .	13
<b>Disc Information</b> . . . . .	14
<b>Cautions of Use</b> . . . . .	15
<b>Trouble Shooting</b> . . . . .	16
<b>Specifications</b> . . . . .	17

Power	DC12V
Current Consumption	48W Max
Screen Format	16:10
Resolution	1440*900 pixel
System	NTSC/PAL
Video Input	1EA
Video Output	1EA
A/V Input	2EA
A/V Output	2EA
Disc Format	MP3/VCD/DVD/CD/CD-R CD-RW/DVD-R/DVD-RW
IR Transmitter	Yes
FM Transmitter	Yes
Dome Light	Yes
Remote Control	Yes
Dimensions (mm)	(W) 545* (D) 435* (H) 65

### Note:

This equipment can be generated, used and accordance with the instruction manual, and, if not installed and used in accordance with the instruction manual, may cause harmful interference to radio communications. Operation of this equipment in a residential area is likely to cause harmful interference in which case the user will be required to correct the interference at his own expense.

## Trouble Shooting

TROUBLE	ACTION
No power	Check to see that the AC power cable is connected properly.
No picture	Make sure that the equipment is connected properly. Check to see that the connected monitor is turned on
Stopped picture	Check to see that the video cable is connected. Check to see that the monitor is turned on.
The playback picture is poor	Clean the disc
No color	The color system set by this unit does not match the color system of the monitor. Check the color system of the unit.
Distorted sound	Adjust the video system by pressing the TV system button. (PAL, NTSC)
The remote control doesn't work properly	Remove any obstacles between the remote control unit and the remote control sensor. Operate the remote control at a shorter distance.
"DISK ERROR" is display on the screen	Set the power button to OFF and then back to ON alternatively, Turn off the power, disconnect the power plug, and then reconnect it.

### Check point

When a disc is brought from a cold environment to a hot one, there may be steam on the face of the disc, or water will appear on the pickup lens. It will affect the play.

1. Remove the disc from the DVD player.
2. Turn on the power and leave it on for an hour to vaporize the condensation.
3. You can operate the DVD player without any problem.

### Caution

Please read and observe all warnings and instructions in this owner's manual and those marked on the unit. Retain this booklet for future reference.

There are two kinds of alarm symbols as follows:

#### WARNING

The lightning flash with arrowhead symbol within an equilateral triangle is intended to alert the user to the presence of "dangerous voltage" within the product's enclosure that may be of sufficient magnitude to constitute a risk of electric shock to persons.

#### CAUTION

The exclamation point within an equilateral triangle is intended to alert the user to the presence of important operating and maintenance (servicing) instructions in the literature accompanying the product.

### WARNING

The driver should never operate these products while the vehicle is in motion!

Installation of all TV monitors must be out of the driver's field of vision!

Do not try and service these products yourself, seek only a qualified service center or factory service center.

Be careful not to drop or apply undue pressure to the front panel of your video monitor. If the screen cracks due to misuse your warranty will be void!

Make sure to keep products away from heater ducts or vents and out of direct sunlight. Do not mount forward of the driver's shoulders.

Be careful not to overload your cigarette lighter plug by adding more than one device at a time.

Use extra caution with any liquids in your car. If you or your child spill any liquid on these products, pull your vehicle to the roadside and turn the key off to disconnect or wipe the products with a towel. Do not operate the equipment until all liquids have either evaporated or you have had the monitor inspected at a service center by a qualified Technician. Severe harm or death can occur!

Use only a damp cloth to clean the screen and use only purified water on the cloth. Wring out all excess water prior to wiping the screen. Do not use any cleaners or chemicals to clean the screen. In most cases a dry cloth will do!

Do not mount the product where it will obstruct the deployment of the airbag or in an area where it would affect the vehicular control. Also be careful to avoid mounting the product where it can become hazardous during sudden stops or in the event of an accident.

### Caution

Quality installations are best performed by qualified and certified installers.

Watching the monitor for an extended period of time without the engine running may deplete the vehicle's battery charge

This product is designed for operation with a 12 Volt DC, negative ground vehicle. It is not suitable for operation under other conditions or voltages.

### Check Point

- 1 The operating temperature of this product is limited to  $-4^{\circ}\text{ F} \sim +176^{\circ}\text{ F}$ . Your vehicle can reach temperatures up to  $212^{\circ}\text{ F}$  in the summertime.
- 2 From time to time when your vehicle is extremely hot or cold you must allow time for your air conditioner or heater too cool or heat the vehicle and for operating temperatures to return to normal operating ranges. Your monitor will return to its normal functions when these operating ranges are achieved.
- 3 Your optimum picture quality is achieved when you are directly in front of the monitor (  $\pm 30$  degrees).
- 4 Do not open covers and repair yourself. Refer servicing to qualified personnel.
- 5 DVD Players use an invisible laser beam which can cause hazardous radiation exposure. Be sure to operate the unit correctly as instructed.
- 6 Do not cut the car power supply off while a disc is playing. It can cause damage to the DVD Player.

## Cautions on Use

### Handling

When holding with both hands



### Cleaning discs

Fingerprints or dust on discs may reduce sound or picture quality. remove them by gently wiping the disc from the center toward the edges using a soft cloth



- . Do not use damaged ( cracked or warped ) disc.
  - . Do not scratch signal surface or let it dirty.
  - . Do not attach paper or seals to discs.
  - . The player may be damaged if there is any exposed glue, etc. on discs.
- using such discs.  
Check carefully for any exposed glue before are often attached to the discs.  
For rental disc in particular, extra labels are often attached to the discs.  
Check carefully for any exposed glue before using such discs.

Do not use benzene. Thinner or other volatile chemicals.  
Do not use record spray or an antistatic spray either.  
We recommend using the separately sold cleaning set to clean discs.  
For tough dirt, apply some water to a soft cloth, wring out thoroughly, wipe off the dirt, then wipe off the disc with a dry cloth.

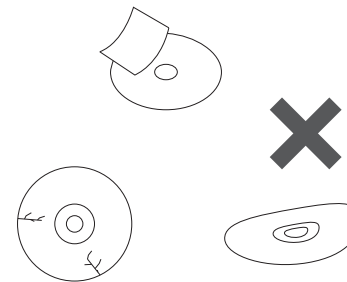

### Irregularly shaped discs

Irregularly shaped discs( heart-shaped discs, hexagonal discs, etc. ) cannot be played on this player.  
Doing so could damage the player.  
Never use such discs.

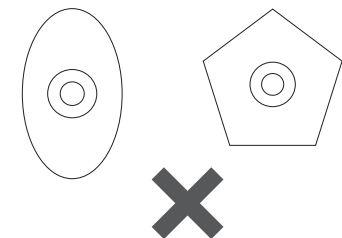

### Storing discs

Always place discs in their case and store them vertically.  
Avoid storing discs in hot or humid places, places exposed to direct sunlight and places in which the temperature is extremely low.

- . Read any cautions included with the disc carefully

## Disc Information

### DVD features

DVD disc provide high-resolution images with high- quality sound and surround sound effects. This DVD player can play not only DVD discs of various versions, but also S-VCD ,VCD , audio CD and MP3 discs.

Each disc plays only the information saved on it, and some functions cannot be utilized.

### Discs that cannot be played

DVD-RW, DVD- REM, CD-ROM, CD- EXTRA discs cannot be played on this unit. Also, a CD or a CD-RW which was recorded on special software cannot be played.

### Region code

Your DVD player is designed and manufactured to region management information that is recorded on a DVD disc. The region number of this DVD Player is 1 . This DVD player plays free code also.

### Copyright protection.

This product incorporates copyright protection technology that is protected by methods claims of certain U.S. patents and other intellectual property rights owned by the Macrovision Corporation and other rights.Owner's use of this copyright protection technology must be authorized by the Macrovision Corporation, and is intended for home and other limited viewing uses only unless otherwise authorized by the Macrovision Corporation.

### How to handle the disc

Don't touch the shiny side of the disc ( the side with the embedded information ).  
Don't stick a lable or a glue - based note on either side of the disc. Don't use discs that have glue or a damaged gluey label- it might result in damage to your DVD player, Don't put discs in the sunshine. Park your car in the shade.

### Caution

Wipe softly with a wet cloth and then with a dry one.  
Before playback, wipe the disc outward from the center with a clean cloth.  
Do not use any type of solvent such as thinner, benzene, coommercially - available cleannners or antistatic spray.

To avoid damaging your DVD player, don't use a scratched disc.

## Name and function of each part

### UNIT

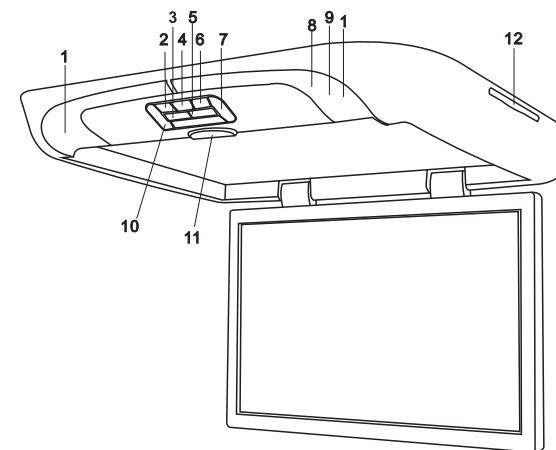

- |                                       |                  |
|---------------------------------------|------------------|
| 1. IR wireless transmitter/Dome light | 2. Up button     |
| 3. PLAY/PAUSE button                  | 4. Menu button   |
| 5. EJECT button                       | 6. Down button   |
| 7. Dome light switch                  | 8. Power led     |
| 9. Remote control                     | 10. Power button |
| 11. Monitor release button            | 12. Disc tray    |



- |                       |                      |                 |
|-----------------------|----------------------|-----------------|
| 13.Right audio output | 14.Left audio output | 15.video output |
| 16.SD card slot       | 17.USB port          |                 |

## Name and function of each part

### Remote Control Unit

#### 1. MENU button

Press this button to display the LCD's menu screen.

#### 2. EJECT button

Press this button to slide the disc out and in.

#### 3. NUMBER buttons

Press these buttons to input numbers.

#### 4. REV/FWD-Scan buttons

Use these buttons to scan forward and backward through pictures or sound.

#### 5. TITLE button

Press this button to display the DVD's title.

#### 6. MENU button

Press this button to display the DVD's menu screen.

#### 7. ZOOM button

Zoom in or zoom out the picture on screen.

#### 8. ANGLE button

Press it to switch the picture's angle.

#### 9. SLOW button

Press this button slow playback at 1/2 , 1/4 , 1/6 , 1/8 speed.

#### 10. Program button

Use this button to program individually.

#### 11. VOL+ button

Press this button to volume up.

#### 12. PBC button

Playback control.

#### 13. POWER button

The power turns on and off when this button is pressed.

#### 14. Play/Pause button

Use this button to play picture or sound or stop temporarily.

#### 15. STOP button

Press this button to stop playback of the picture or sound

#### 16. 10+ button

Press this button to select a program of which the sequence number on the disc is more than 10.

#### 17 . DVD/AV buttons

Press these buttons to DVD/AV functions switch screen.

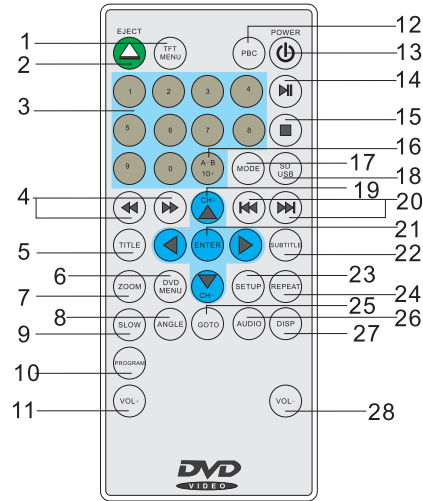

## Installation (Professional installation recommended)

1. Unpack and check the contents. Disassemble the metal support bracket from the unit as shown in the illustration, by unscrwing the six screws on the unit body.

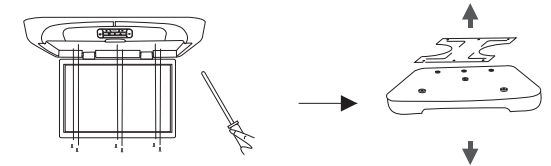

2. Tighten the metal support bracket to the ceiling support beam(s), using the supplied screws. Take extra care to not penetrate the roof of your car.

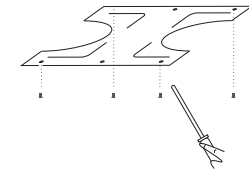

3. Connect the wiring harness, according to the diagram under "Connection Diagram" on the following diagram. to the wires located in the dome light of your vehicle.

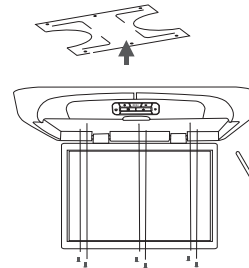

4. Flip the monitor screen down and tighten the monitor to the support bracket, using the supplied screws.

## Connection Diagram

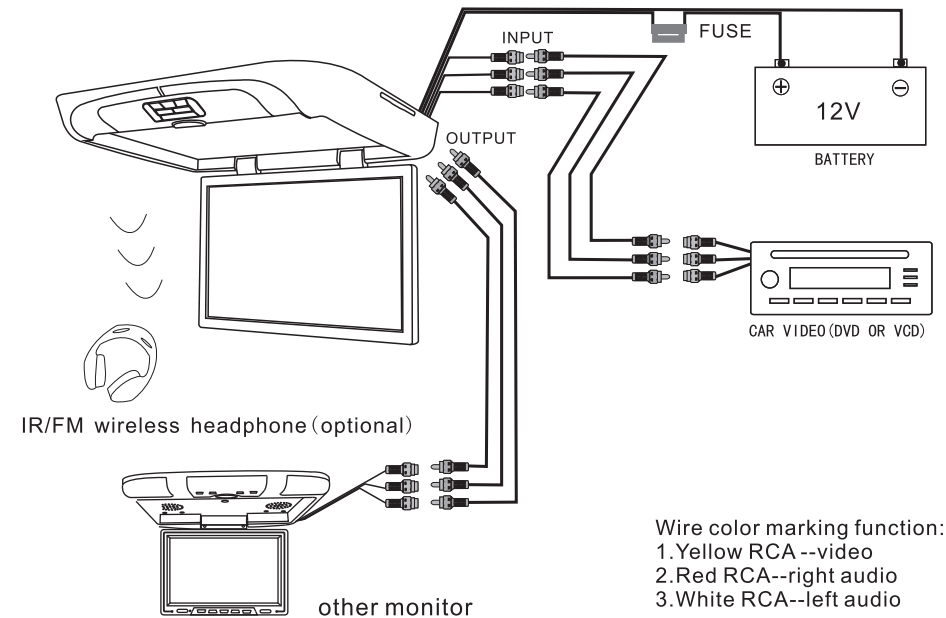



## Advanced Functions

### Viewing in slow motion DVDs and video CDs

Press the SLOW button during playback, the playback speed becomes 1/2 , 1/4 , 1/6 , or 1/8 of the normal speed each time you press the SLOW button.

### Repeat play DVDs, Video CDs and CDs

#### . Repeat a TITLE, CHAPTER, or TRACK

Press the REPEAT button.

Select the title, chapter, or track you want to repeat.

#### . Repeat a section between Point A and B.

During playback, press A-B button on the remote control at the starting point of the Section you want to repeat. ( Point A)

Press A-B button again at the ending point of the section you want to repeat. ( Point B )

Press A-B button again to cancel the A-B repeat function.

#### . Selecting the DVD's angle ( multi-angle)

Press the ANGLE button while playing back a scene record with multiple angels.

If your DVD is not recorded with multiple angles. Press ANGLE button will not have any effect.

### SD card & USB play

While in DVD source , Insert MMC/SD/MS or connect USB , Press <SD/USB> button , when MMC/SD/MS or USB found . You can select media and then choose MMC/SD/MS or USB to play.

Note: please do not use the removable hard disk . This will lead to abnormal working.

#### .SD card & USB play interface

- 1.Music display window
- 2.Display music played currently
- 3.Display folder played currently
- 4.Folder window
- 5.Music
- 6.Picture
- 7.Video

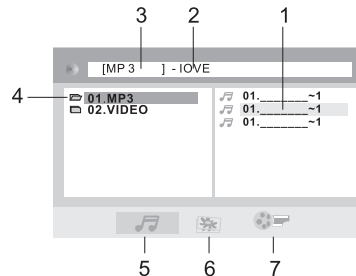

#### .Switch Music/picture/video play

Press [◀/▶] of the remote control to move the cursor leftwards/rightwards to select music, picture or video . Red shows that it has been selected , press [ ] button to confirm selection .

Press [▲/▼] of the remote control to select upwards/downwards music or folder to play.Red shows that it has been selected , press [ ] to confirm selection.

#### .Previous/Next

Press [◀◀]/[▶▶] of the remote control to play the previous/next music

#### .Fast Forward/Fast Back

Press [◀◀◀]/[▶▶▶] of the remote control to realize x2,x4,x8,x20 fast forward/fast back play.

#### .Pause/Play

Press [⏮] of the remote control to play or pause play.

#### .Stop

Press [■] of the remote control to stop play.

#### 18. SD CARD & USB button

Press the button to select disc/SD card/USB input.

#### 19. CURSOR▲/▼, ◀/▶ [LCD menu adjustment button

Use these buttons when select setting items to move the cursor up, down, left and right. Press up , and down buttons to change TV channels.

#### 20. PRE/ NEXT buttons

Use these buttons to search for the beginnings of tracks or chapters.

#### 21. ENTER button

Press it to enter setting.

#### 22. SUBTITLE button

Press it to switch the DVD's subtitle languages.

#### 23. SETUP button

Press it to enter or quit the SETUP Menu.

#### 24. REPEAT button

For DVDs use it to play title or chapters repeatedly.  
For CDs, use it to play tracks or the entire disc repeatedly.

#### 25. GOTO button

Press this button , select time or chapter to goto and play when disc is playing.

#### 26 . AUDIO button

Press it to switch the audio Languages.

#### 27. DISPLAY button

Press it to display the disc information.

#### 28. VOL- . button

Press this button to volume down.

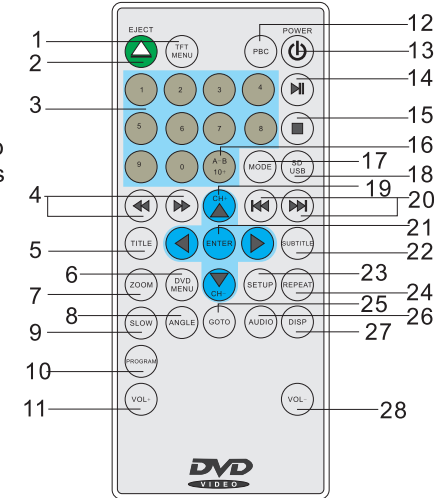

## Picture control

---

### Picture selections:

use to achieve the desired settings.

1. Press the MENU (Unit or Remote) button to bring up the on-screen picture control menu.
2. Select the desired menu by pressing the UP (Unit, Remote) buttons to change PICTURE, AUDIO, FUNCTION, OSD.
3. Adjust the current settings with the DOWN (Unit, Remote) buttons, press UP buttons, then press UP or DOWN on the unit to achieve the desired settings.

## Playing a disc

---

### Playing DVD player

1. Press the POWER (Unit, Remote) buttons.
  2. Load a disc in the disc loading slot with the label side front.
- Insert a disc in the disc loading slot and it will be played automatically.

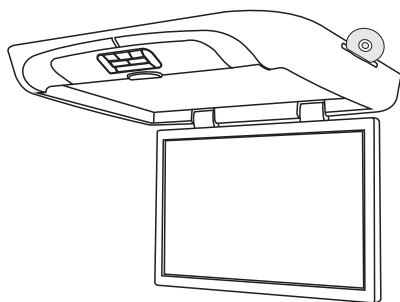

## Basic operation

---

### FM channel:

press menu button, press (unit +) or (remote right) button, then press (unit AV) or (remote down) to select the AUDIO CONTROL item, press + or - to adjust of FM . press (unit AV) or (remote down) button, press + or - to select FM channel.

## Playback Functions

---

### .Stopping the disc

Press the STOP button.

Resume function (DVDs and Video CDs)

Playback will be stopped when the STOP button is pressed, when the play button is pressed.

Playback starts from the position at which it was stopped. When the disc is removed or the STOP button is pressed again, the resume function is cancelled.

### .Hint:

For some discs, playback may not start from the position at which was stopped. If the STOP button then the previous is pressed while the resume function is on, playback starts from the beginning of the title.

### . Pausing the disc

Press the play/pause button.

Press the button again to resume playback.

### .Scanning forward and backward

During playback, press the previous or next button.

Reverse direction

Forward direction

### .Returning to the previous chapter or track DVDs ,Video CDs and CDs

Press the previous button during playback.

When pressed, playback returns to the beginning of the previous chapter or track.

### .Moving ahead to the next chapter or track DVDs, Video CDs and CDs

Press the next button during playback.

When pressed once, playback moves forward to the next chapter or track.

### . Removing discs

1. Press the STOP button.

2. Press the EJECT button to open the disc.

3. Remove the disc.

### .Note:

With CDs or on-sided DVDs, you do not have to worry about touching the label (printed) side or the disc with your finger. Two-sided DVDs, however, have signals recorded on both sides, so be careful not to scratch them when removing them from the player.

### .Search for a specific scene

1. Press the SEARCH button.

2. Press the number button to select specific time or title chapter.

3. Press the ENTER button and playback starts from the specific chapter number



Playback Functions

Playing disc

1. Loading the disc

- . One of the following messages appears on the LCD: DVD , VCD , CD.
- . For some discs, playback starts automatically when the disc is close.
- . When discs for which program memories are set, playback starts automatically in the order.

2. Press the PLAY/ PAUSE button

- . Playback starts.
- For some discs, a menu screen appears. For video CDs, playing the disc according to the instructions on the disc's menu screens I called PBC ( playback control) playback.

3.Hint:

- . For video CDs, it is also possible to play a disc without displaying the menu screen. For example, to play from track 1 , press the 1 number button while in the stop mode. \*When play CD disc or MP3 discs, you are recommended to turn off the TFT LCD screen to save power. ( Please make reference of" TFT ON/ OFF Function" on Page 10 and Page 12.)

If a menu screen appears

For DVDs with menu screen or video CDs with playback control ( PBC) , a menu screen appears.

DVD

Use the cursor buttons to select the item, then press the ENTER button. Press the number button on the remote control unit to select item. Example: For DVDs with menu screen.

TITLE MENU  
1 POP  
2 JAZZ  
3 COUNTRY  
4R&B  
5 CLASSICAL

1 POP  
2 JAZZ  
3 COUNTRY  
4R&B  
5 CLASSICAL

Video CD

Press the number button on the remote control unit to select item.

To display the menu screen

The way in which the menu screen is displayed differs from disc to disc .Press the MENU, TITLE button during playback or DVDs , the RETURN button during PBC playback of video CDs. For details, refer to documentation included with the disc.

How To Setup Menu

You can easily modify setup information on the setup menu.

System Setting

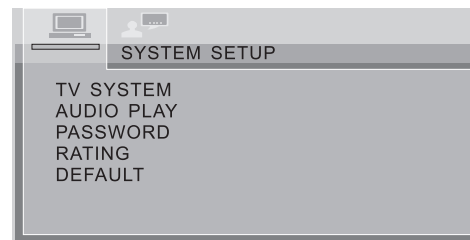

Please press setup button, then press ▲/▼ to select [SYSTEM] items.

Still Mode Setting

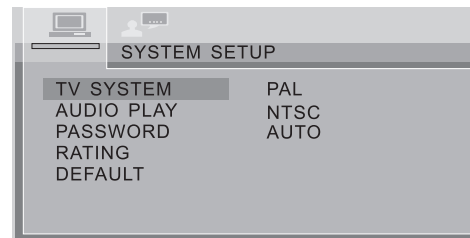

2. STILL MODE  
To setup display mode of still pictures. There are three options[AUTO] [FIELD] and [FRAME].

Auto Play Setting

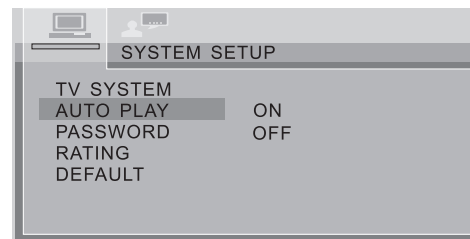

3. AUTO PLAY  
To setup DISC auto play mode.

**Parental Lock Password Setting**

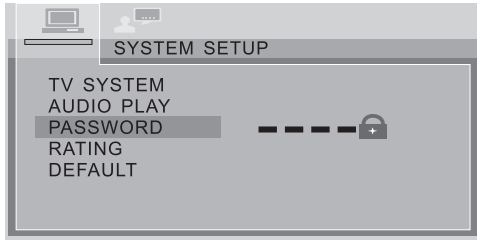

5. PASSWORD  
Setup parental lock password. It is acceptable to input new password with 4 numeral to re-setup the parental lock.

**Parental Lock Setting**

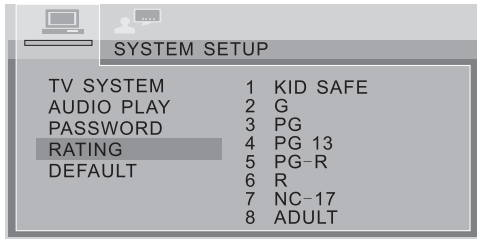

4. RATINGS  
According to different grade, setup the parental lock.  
Hint:  
Normally, the grade is set as [0 LOCK ALL]

**DEFAULTS Setting**

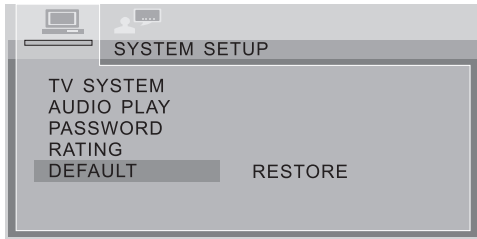

2. DEFAULTS  
Setup all menus to the initial setting of factory.

**Language Setting**

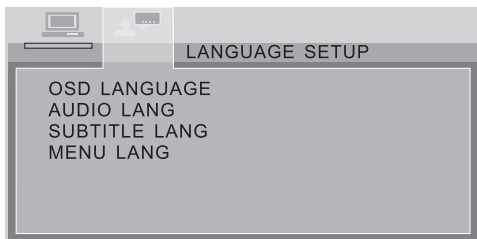

Please press setup button, then press ◀/▶ to select [LANGUAGE] items.press ▲/▼ to select language menu.

**OSD Language Setting**

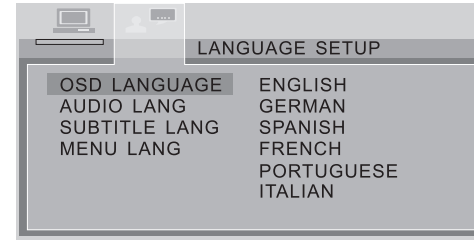

LANGUAGE  
To setup OSD languages

**Audio Language Setting**

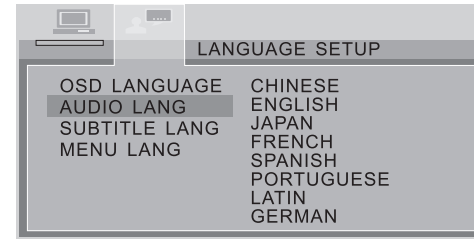

1. AUDIO  
To setup disc output languages.

**Subtitle Language Setting**

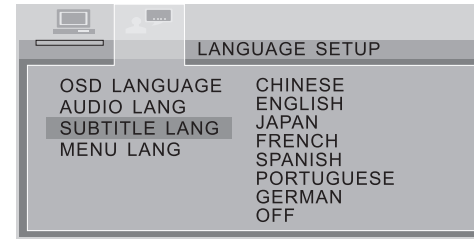

2. SUBTITLE  
To setup disc subtitle languages.

**MENUS Language Setting**

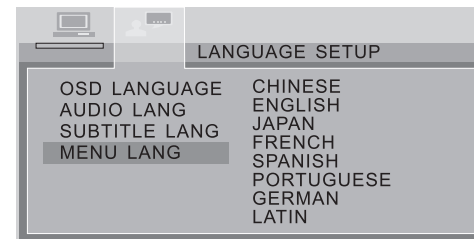

3. MENUS  
To setup DISC MENU languages

## Free Manuals Download Website

<http://myh66.com>

<http://usermanuals.us>

<http://www.somanuals.com>

<http://www.4manuals.cc>

<http://www.manual-lib.com>

<http://www.404manual.com>

<http://www.luxmanual.com>

<http://aubethermostatmanual.com>

Golf course search by state

<http://golfingnear.com>

Email search by domain

<http://emailbydomain.com>

Auto manuals search

<http://auto.somanuals.com>

TV manuals search

<http://tv.somanuals.com>