

# **OWNER'S MANUAL**

# **PYLE®**

ANTI-SHOCK COMPACT DISC PLAYER  
AUXILIARY INPUT AND  
SUPER POWER OUTPUT  
FOLD-DOWN FACE DETACHABLE PANEL  
FM-AM FM-MPX RADIO RECEIVER  
WITH REMOTE CONTROL

**MODEL : PLCD38**

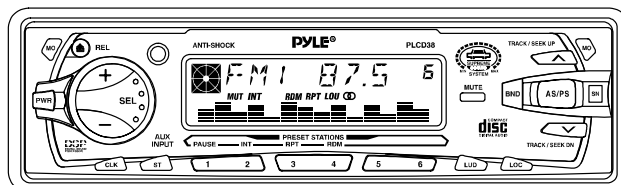

P / N : 570-981812-05

## LOCATION OF CONTROLS

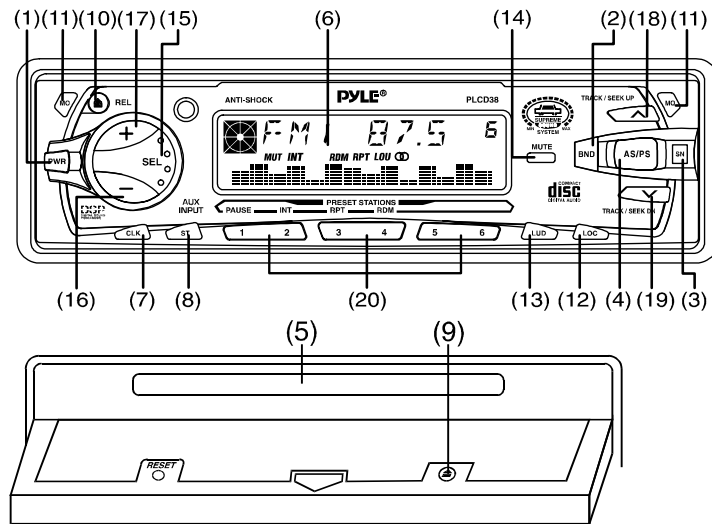
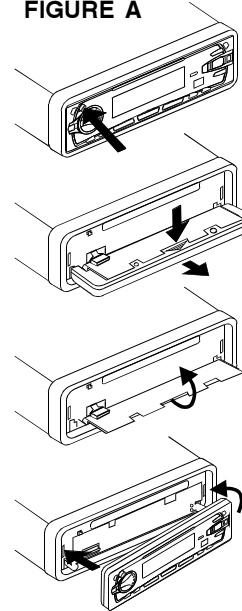

FIGURE A



## OPERATING INSTRUCTIONS

### 1. POWER ON/OFF CONTROL

Press the button to turn the power "ON" or "OFF".

**Note :** The unit can be turn on by pressing any keys on the panel (except panel release button & disc eject button). It will help the user who cannot find the power button in dark.

### 2. BAND SELECTOR

Each time this button is pressed, the radio band is changed. The indication "FM1", "FM2", "FM3", "MW1" or "MW2" will appear on the display according to your selection.

### 3. SCAN CONTROL

Press this button to scan the receivable FM / MW stations. When receivable stations are tuned in, they are monitored for approximately 5 seconds before advancing to the next receivable station. Press SCAN button once again to stop scanning as desired.

### 4. PRE-SCAN/AUTO-STORE BUTTON

This button allows you to enjoy "Preset Memory Scan" function by pushing it shortly, and "Auto-Store Memory" function by pushing it more than 2 seconds.

\* PS (PRESET MEMORY SCAN) - It calls the memorized station frequencies ( from 1-6 ) automatically every 5 seconds.

\* AS (AUTO-STORE MEMORY) - It searches all station frequencies upward and memorize automatically 6 stations by catching the frequency which has scan-stop level, the memorized station is shown on LCD as "CH1...6". After memorizing, auto-store memory function will be changed to "Preset Memory Scan" function automatically.

### 5. DISC SLOT

Holding the disc and insert into the disc slot. The CD mechanism will automatically engage into CD play mode.

### 6. LCD DIGITAL DISPLAY

The unit utilizes a digital type display which shows numerical indication of station FREQUENCY and other FUNCTIONS.

### 7. CLOCK CONTROL

During radio and CD operation, press this button to call the time display on the incorporated quartz clock.

#### SETTING CLOCK TIME

1. Press CLOCK button and hold it until the display flash and release.
2. Press "+" button to set HOUR and press "-" to set MINUTE.

### 8. STEREO/MONO CONTROL

Press this button to select "FM STEREO" or "MONO" reception.

- 9. EJECT BUTTON**  
Press the button to eject the disc inside disc slot.
- 10. PANEL RELEASE BUTTON (FIGURE A)**  
To detach the front panel, press the release button so that the panel fold down from vertical position to horizontal position and then pull it off of the chassis at horizontal position.  
To re-attach the panel, push the fold-down metal frame forward until it locks to the original position. Then, put the panel at the right side of the position first and then press the left side of the panel until the mechanism lock it into place.
- 11. MODE SELECTION**  
Press this button to select Radio (TUNER), CD (S-CDP), or Auxiliary input (AUX) mode.
- 12. LOCAL/DISTANT SELECTOR**  
Press this button to prevent strong local stations from overlapping weaker stations. For normal operation, press this button again for distance.
- 13. LOUD CONTROL**  
Press this button to activate the loudness circuitry which compensates for loss of high and low frequencies during low volume levels.
- 14. MUTE CONTROL**  
Press this button to mute the volume control and "MUT" will appear on LCD display.
- 15. AUDIO / SETTING SELECT**  
Briefly press the button to select volume, bass, treble, balance or fader adjustment in cyclical mode. When pressing the button for more than 2 seconds, it activates as unit setting selection in cyclical mode as following. The unit setting can be changed by using either "VOL +" or "VOL -" button.
- DSP OFF/ POP M/ ROCK M/ CLASS M/ FLAT M
  - BEEP OFF/BEEP ON (not available for this model)
  - SEEK 1 (tune up/down button performs fast tune function) / SEEK 2 (performs auto tuning function when tune up/down button pressed more than 1 second)
  - COLOR 1 / COLOR 2 (not available for this model)
  - VOL LAST / VOL ADJ (preset volume level when unit turn on)
- 16/17. AUDIO LEVEL DOWN/UP CONTROL (- Button) / (+ Button)**  
Press "SEL" button shortly and then pressing "+" or "-" button to adjust level of volume, bass, treble, balance or fader.
- VOLUME - Press the (+) button to increase, or (-) button to decrease volume level.
  - BASS - While "BASS" is being displayed, press (+) button to increase or (-) button to decrease the bass level.
  - TREBLE - While "TREB" is being displayed, press (+) button to increase or (-) button to decrease the treble level.
  - BALANCE - While "BAL" is being displayed, press (+) or (-) button to level balance of speaker right and left.
  - FADER - While "FAD" is being displayed, press (+) or (-) button to level fader of speaker front and rear.
- 18/19. MANUAL UP/DOWN TUNING / TRACK SEEK UP/DOWN CONTROL**  
On radio mode, press the button will tune one frequency step higher or lower. Pressing the button more than 1 second can performs fast tuning function or auto tuning function.
- On CD mode, press this button will locate the beginning of the track being played or will locate the beginning of the next track. When pressing more than 2 seconds, it will move fast forward or fast backward to a specific position of a CD track.
- 20. STATION PRESET BUTTON (1-6)**  
The PRESET BUTTONS on the unit are used to store station frequencies which you may wish to recall. Each preset button can store FM1, FM2, FM3, MW1, MW2 station frequency. Pressing the button momentarily recalls the station frequency which was memorized. There are 6 preset buttons, giving you capability of storing 18FM / 12MW.
- NOTE:** When the preset button to be memorized is kept pressed for more than 2 seconds, the receiving station frequency will be stored in the button pressed. After this, the memorized station can be recalled by pressing the button once.
- On CD Mode**
- **Preset 1** - press this button to pause the disc played.
  - **Preset 2** - press this button to scan the first 10 seconds of all the tracks on the currently selected disc.
  - **Preset 3** - press this button to repeat the current track of the disc.
  - **Preset 4** - press this button to play disc at random order - Disc shuffle play.

## WIRE CONNECTION

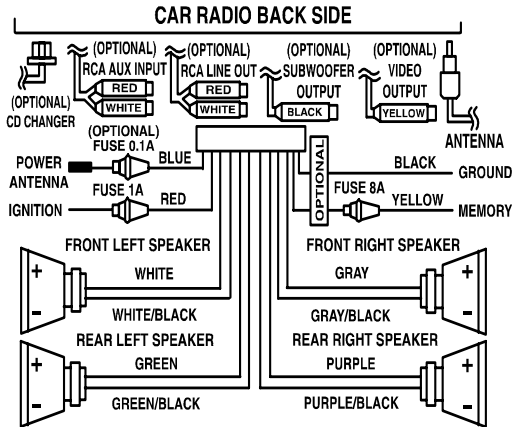

**CAUTION :** Do not connect the speaker wires to chassis or car body. Each speaker wire cannot be soldered together with other wires. Otherwise, the unit will be damaged and no sound will come out anymore.

## REMOTE CONTROL

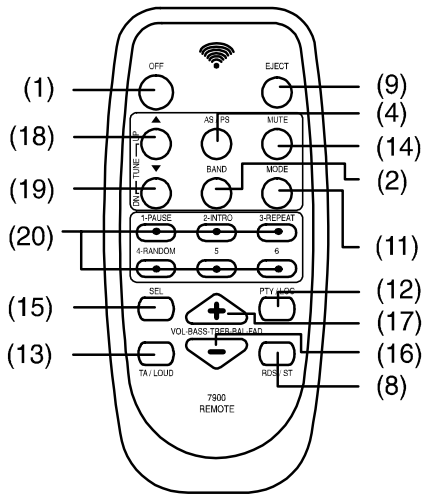

## UNIT REMOVAL

1. Remove Front Control Panel.
2. Slightly insert the key into the slot and gently to release.
3. Separate the sleeve from the unit. Keep release key in a safe place as you may need for future removal of unit.

P/N : 570-981812-05

## RESET FUNCTION

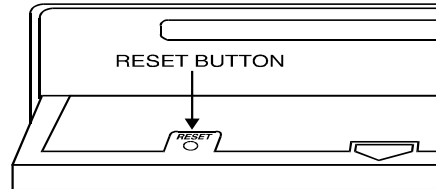

The RESET button is located at the back of the panel. It is recessed in order to prevent accidental engagement, and can be activated with the tip of a ball-point pen or any similar pointed object. This reset circuitry is provided in order to protect the unit's microprocessor, and should only be activated under the following conditions :

- a) Initial installation after all wiring is completed.
- b) Abnormal operation is encountered such as numerical indication on display is erratic.
- c) Whenever the reset button is activated, all preset memory content will be erased and must be reprogrammed.

## INSTALLATION

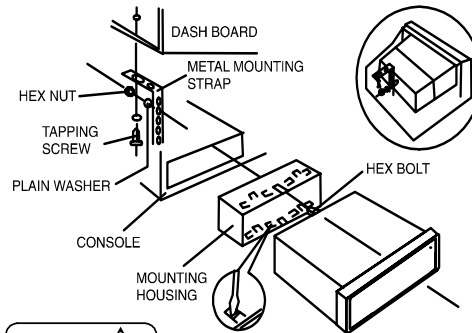

**CAUTION :** DO NOT PLACE THE UNIT OVER THE MAXIMUM INSTALLATION ANGLE OF 30°. OTHERWISE, THE UNIT MAY NOT WORK PROPERLY.

### WARNING!!

Due to protection of CD Mechanism, two small screws on the top of the unit must be released before operate the unit. Otherwise, the CD Mechanism can not be working properly.

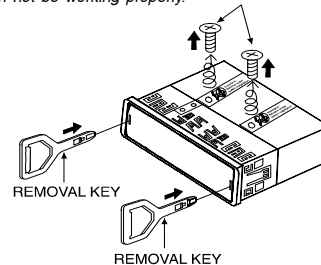

## Free Manuals Download Website

<http://myh66.com>

<http://usermanuals.us>

<http://www.somanuals.com>

<http://www.4manuals.cc>

<http://www.manual-lib.com>

<http://www.404manual.com>

<http://www.luxmanual.com>

<http://aubethermostatmanual.com>

Golf course search by state

<http://golfingnear.com>

Email search by domain

<http://emailbydomain.com>

Auto manuals search

<http://auto.somanuals.com>

TV manuals search

<http://tv.somanuals.com>