

## OWNER'S MANUAL

---

### Mobile Video System

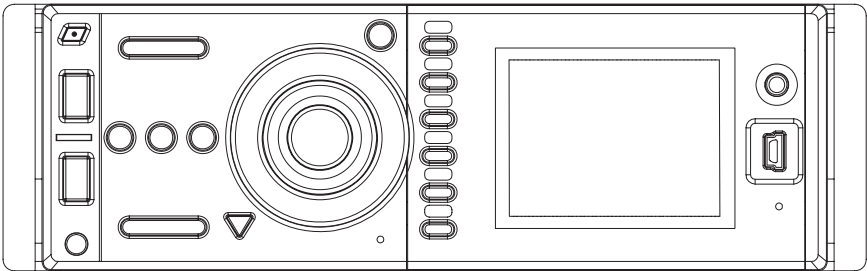

- **Motorized Slide Down Panel**
- **2.5 Inch TFT Color Monitor**
- **Car DVD/VCD/CD/MP3 Player/TV Tuner**
- **AM/FM Digital PII Tuning Radio**
- **MPEG4 Player**
- **USB Connect**
- **Remote Control**

# CONTENTS

---

<b>Safety Information</b> .....	<b>2</b>
<b>Disc Notes</b> .....	<b>3</b>
<b>Installation</b> .....	<b>4</b>
<b>Change Angle</b> .....	<b>6</b>
<b>Electric Connection</b> .....	<b>7</b>
<b>Remote Control</b> .....	<b>8</b>
<b>Basic Operation</b> .....	<b>10</b>
MP3/WMA/JPEG Disc Play .....	13
AUX Operation .....	13
TFT Monitor Operation .....	14
Rear View Camera .....	14
MPEG4 Disc Play .....	14
USB Operation .....	15
On-Screen Display Function .....	15
Multi-Audio Language Function .....	16
Multi-Subtitle Language Function .....	16
Multi-Angle Function .....	16
Title Menu Function .....	16
TV Operation .....	16
<b>Setup</b> .....	<b>17</b>
General Setup .....	17
Speaker Setup .....	19
Dolby Digital Setup .....	19
Preferences Setup .....	20
Defaults Table .....	21
<b>Specifications</b> .....	<b>22</b>
<b>Trouble Shooting</b> .....	<b>23</b>

# SAFETY INFORMATION

---

## **CAUTION:**

THIS DVD PLAYER IS A CLASS I LASER PRODUCT. HOWEVER THIS DVD PLAYER USES A VISIBLE/INVISIBLE LASER BEAM WHICH COULD CAUSE . HAZARDOUS RADIATION EXPOSURE IF DIRECTED. BE SURE TO OPERATE THE DVD PLAYER CORRECTLY AS INSTRUCTED.

USE OF CONTROLS OR ADJUSTMENTS OR PERFORMANCE OF PROCEDURES OTHER THAN THOSE SPECIFIED HEREIN MAY RESULT IN HAZARDOUS RADIATION EXPOSURE. DO NOT OPEN COVERS AND DO NOT REPAIR YOURSELF. REFER SERVICING TO QUALIFIED PERSONNEL.

## **WARNING:**

TO REDUCE THE RISK OF FIRE OR ELECTRIC SHOCK, DO NOT EXPOSE THIS EQUIPMENT TO RAIN OR MOISTURE.

TO REDUCE THE RISK OF FIRE OR ELECTRIC SHOCK, AND ANNOYING INTERFERENCE, USE ONLY THE RECOMMENDED ACCESSORIES.

THIS DEVICE IS INTENDED FOR CONTINUOUS OPERATION.

This product incorporates copyright protection technology that is protected by method claims of certain U.S. Patents and other intellectual property rights owned by Macrovision Corporation and other rights owners. Use of this copyright protection technology must be authorized by Macro vision Corporation, and is intended for home and other limited viewing uses only unless otherwise authorized by Macrovision Corporation. Reverse engineering or disassembly is prohibited.

## **REGION MANAGEMENT INFORMATION:**

This DVD Player is designed and manufactured to respond to the Region Management Information that is recorded on a DVD disc. If the Region number described on the DVD disc does not correspond to the Region number of this DVD Player, this DVD Player cannot play this disc.

# DISC NOTES

## Disc formats supported by this player



DVD  
12 cm disc  
(Single-sided disc only)



Video CD  
12 cm disc



CD  
12 cm disc  
MP3



12 cm disc

## Discs which cannot be played with this player

- DVD-ROM
- DVD-R/DVD-RAM
- CDV
- CD-G

## Handling and Cleaning

- Dirt, dust, scratches and warping disc will cause misoperation.
- Do not place stickers or make scratches on discs.
- Do not warp discs.
- A disc should always be kept in its case when not in use to prevent from damaging.
- Do not place discs in the following places:
  1. Direct sunlight
  2. Dirty, dusty and damp areas
  3. Near car heaters
  4. On the seats or dashboard

## Disc Cleaning

Use a dry soft cloth to wipe the surface. If the disc is quite dirty, use a soft cloth slightly moistured with isopropyl (rubbing) alcohol. Never use solvents such as benzine, thinner or conventional record cleaners as they may mar the surface of the disc.

### Note:

A disc may become somewhat scratched (although not enough to make it

unusable) depending on your handle it and conditions in the usage environment. Note these scratches are not an indication of any problem with the player.

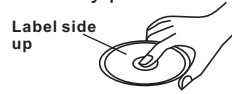

Label side up



Do not touch the underside of the disc



Do not bend

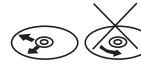

Wipe the disc from center toward the outside edge

## Preparing New Discs with Rough Spots

A new disc may have rough edges on its inside and outside edges. If a disc with rough edges is used, the proper setting will not be performed and the player will not play the disc. Therefore, remove the rough edges in advance by using a ball point pen or pencil as shown on the right. To remove the rough edges, press the side of the pen or pencil against the inside and outside edges of the disc.

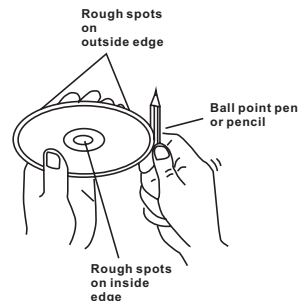

Rough spots on outside edge

Ball point pen or pencil

Rough spots on inside edge

# INSTALLATION

---

## NOTES:

Choose the mounting location where the unit will not interfere with the normal driving function of the driver.

Before finally installing the unit, connect the wiring temporarily and make sure it is all connected up properly and the unit and the system work properly.

Use only the parts included with the unit to ensure proper installation. The use of unauthorized parts can cause malfunctions.

Consult with your nearest dealer if installation requires the drilling of holes or other modifications of the vehicle.

Install the unit where it does not get in the driver's way and cannot injure the passenger if there is a sudden stop, like an emergency stop.

If installation angle exceeds 30 from horizontal, the unit might not give its optimum performance.

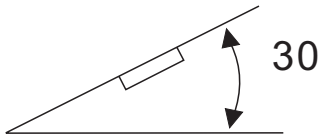

Avoid installing the unit where it would be subject to high temperature, such as from direct sunlight, or from hot air, from the heater, or where it would be subject to dust, dirt or excessive vibration.

## DIN FRONT/REAR-MOUNT

This unit can be properly installed either from "Front"(conventional DIN Front-mount) or "Rear"(DIN Rear-mount installation, utilizing threaded screw holes at the sides of the unit chassis). For details, refer to the following illustrated installation methods.

# INSTALLATION

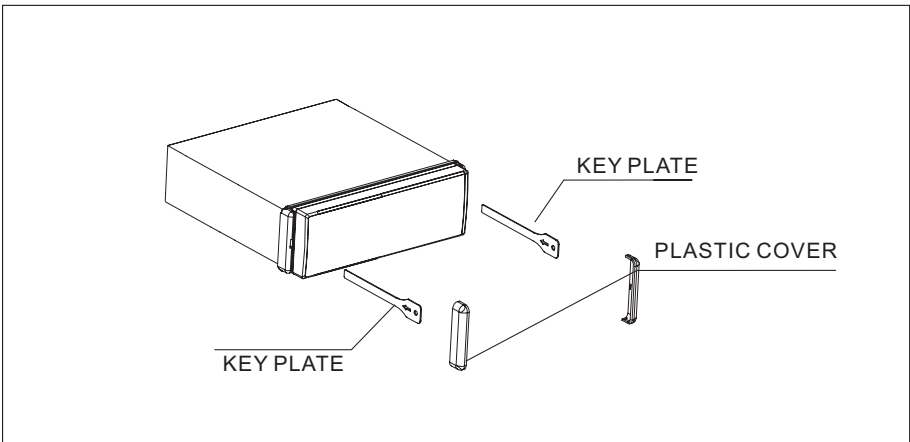
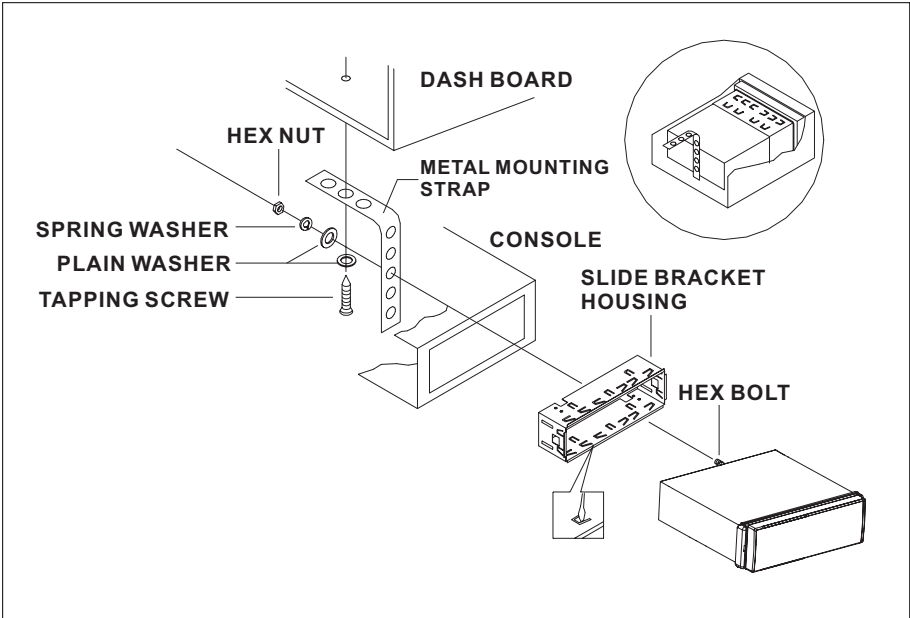

If you want to take CHASSIS out of the SLIDE BRACKET HOUSING, first remove the PLASTIC COVER of the both sides away, then insert the two KEY PLATE into left and right side of chassis as above illustration.

# CHAGNE ANGLE

---

## CHANGING THE CONTROL PANEL ANGLE

When you want to change the angle to play, you can press repeatedly the  (angle) button to select the desired angle as follows:

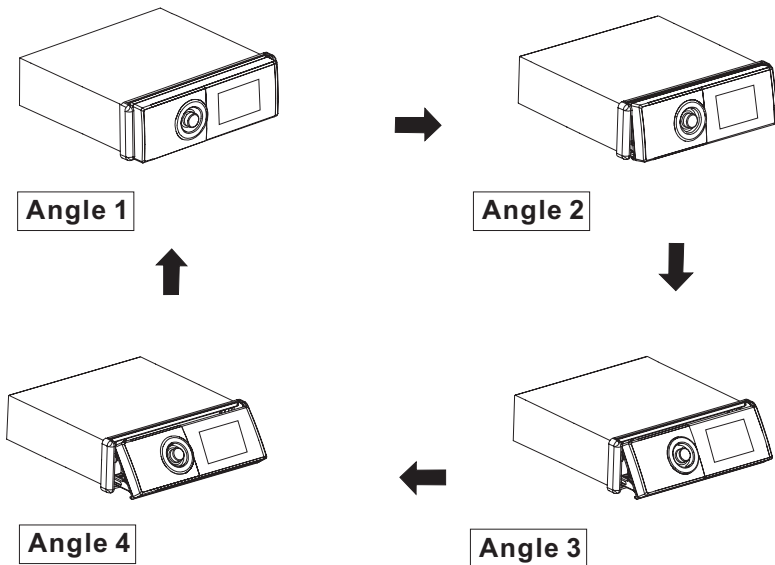

### Caution:

Do not insert your finger behind the control panel

# ELECTRIC CONNECTION

## WIRING CONNECTION

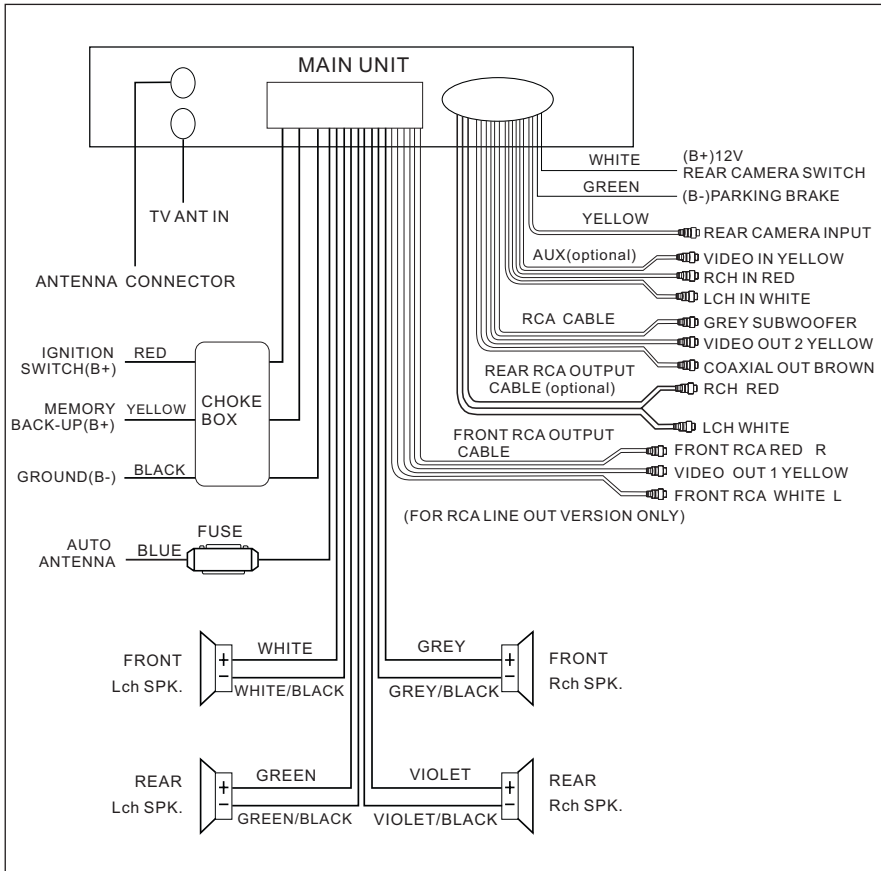



# REMOTE CONTROL

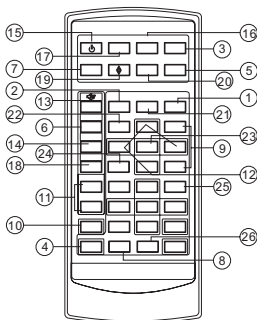

- |   |   |
|---|---|
| <p><b>1.CLK</b><br/> <b>2.MODE</b><br/> <b>3.STOP</b><br/> <b>4.SETUP</b><br/> <b>5.MO/ST(AUDIO)</b></p> <p><b>6. SUBTITLE<br/>LO/DX</b></p> <p><b>7.REPEAT</b><br/> <b>8.GOTO</b><br/> <b>9. ⏮ / ⏭</b></p> <p><b>10.SEL</b></p> <p><b>11. VOL+/VOL-<br/>12. ▲/▼/▶/◀</b></p> <p><b>13.MENU<br/>SUB WOOFER</b></p> <p><b>14.BAND(OSD)</b></p> <p><b>15.POWER</b><br/> <b>16.PLAY/PAUSE</b><br/> <b>17.MUTE</b><br/> <b>18.TITLE/PBC<br/>(A/P)</b></p> <p><b>19. ⬆</b><br/> <b>20.ANGLE</b><br/> <b>21.EQ</b><br/> <b>22.SEARCH ▶▶</b></p> <p><b>23.ENTER</b></p> <p><b>24.SKIP ◀◀</b></p> <p><b>25. 0 - 9</b><br/> <b>26.+10</b></p> | <p>Press it to change the display to clock display.</p> <p>Press it to change between TV, RADIO ,DISC and AUX IN mode.</p> <p>Press it to stop playback.<br/>Display the SETUP menu.</p> <p>In radio mode, press it to select STEREO or MONO mode (In disc mode, press it to changing of the AUDIO soundtrack on multi-audio soundtrack DVD disc. Changing of the sound mode of the VCD/CD disc)</p> <p>Changing of the SUBTITLE language on multi-subtitle language DVD disc. In radio mode,. Press this button for distance reception when you are located at weak signal location, depress it for stronger signal.</p> <p>Switch the Repeat mode of DVD/VCD/CD/MP3 disc.</p> <p>Disc search button, cooperatively used with numeric buttons<br/>Press ▶▶ to skip to the next track &amp; press ⏮ to skip back one track.<br/>(Note:In DVD mode, press continually the ⏮ twice to skip back one track.)</p> <p>Press it repeatedly to change mode through volume , bass, treble, balance , fader, color, bright, contrast and tint modes.</p> <p>Press it to adjust volume level<br/>Cursor buttons in MENU mode. Note: For models without built-in FM Modulator, the ▲/▼ buttons can be used for volume up/down control. In TV mode, press ▶ / ◀ to fine tune. Press the ▲ / ▼ to select channel upward and downward.</p> <p>Press it to display the root menu of the DVD disc. Press and hold for more than 2 seconds can have SUBWOOFER, press it again for more than 2 seconds to release this mode.</p> <p>Display statistical disc information during playback (To change the band in radio stations)</p> <p>Press it to turn on the unit ,press it again to turn off.</p> <p>Press once to pause a play, press again to resume playback.</p> <p>Press it to mute down sound.</p> <p>Display the TITLE menu that is stored in DVD disc changing between PBC ON and PBC OFF on the VCD disc.(Auto store and preset scan function in radio stations .)</p> <p>Press it to change the view angle.</p> <p>Changing of the view angle on multi-angle DVD disc.</p> <p>Press it to turn to equalization function.</p> <p>In TV mode, Press it to search TV channel automatically.<br/>In DISC mode, Press it to start forward rapidly.</p> <p>Confirm the Track/Chapter selected with the number key or selected with the cursor buttons on TV screen.</p> <p>In TV mode, press it to ADD and DELETE channel .<br/>In DISC mode, press it to reverse rapidly</p> <p>Numeric buttons.<br/>Tens digit select button, cooperatively used with numeric buttons.</p> |
|---|---|

# REMOTE CONTROL

---

## Preparing the Remote Control

### Inserting the Batteries

1. First push to inside as the direction indicated by the arrow (See ①) And then Remove the battery holder as the direction indicated by the arrow (See ②).
2. Replace the battery Set a new battery property with (+)side up as illustrated (See ③).
3. Insert the battery holder. Push in the holder to the original position(See ④).

### Using the Remote Control

Face the remote control towards the player front face IR mark (remote control signal receiver).

Operation angle: About  $\pm 30$  degree in each the direction of the front of the IR mark.

To prevent damage to the unit, be sure to follow the connection diagram (page 7).

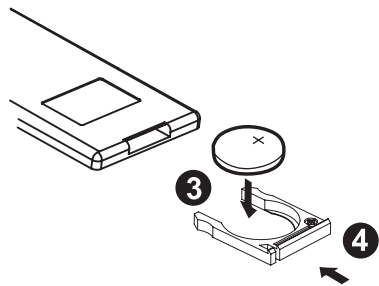
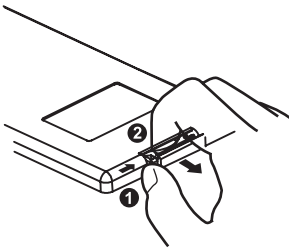

# BASIC OPERATION

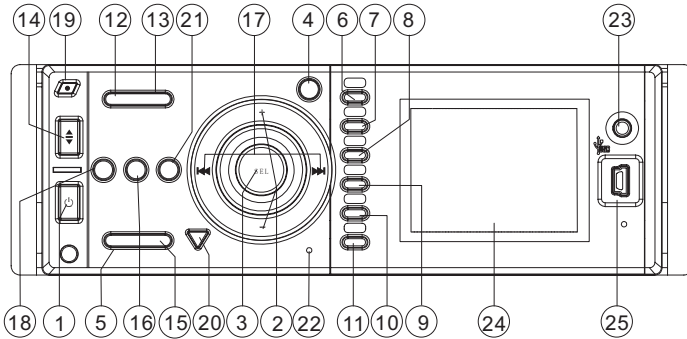

## 1. PWR BUTTON

Press it to turn on the unit. Press it again to turn off.

## 2-3. VOL+/VOL- & SEL BUTTON

Press sel button repeatedly to change mode through volume, bass, treble, balance, fader, color, bright, contrast and tint modes. Face up or down swing the SEL knob VOL + /VOL- to adjust the selected mode.

(The corresponding value will show on the display.)

When mode has not been adjusted for several seconds, display returns to normal radio or CD display.

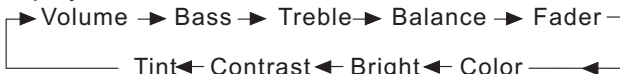

**A. Volume:** Adjust volume level by using VOL + / VOL - button.

Note: The unit is initially set to volume mode.

**B. Bass:** Press SEL button one time. Adjust bass level by using VOL + / VOL - button.

**C. Treble:** Press SEL button two times. Adjust treble level by using VOL + / VOL - button.

**D. Balance:** Press SEL button three times. Adjust sound balance between left and right speakers by using VOL + / VOL - button.

**E. Fader:** Press SEL button four times. Adjust sound balance between front and rear speakers by using VOL + / VOL - button.

(NOTE: the function of the Color, Bright, Contrast and Tint. Please see 14 page.)

## 4. BAND BUTTON

In RADIO mode, press the BAND button on the front panel or on the remote controller to select your desired radio band and word which band is selected will be displayed on LCD. Press it to change the bands as below :



## 5. EQ BUTTON

Press it to turn to equalization function and to select desired audio mode.

There are four kinds of mode as below:



## 6-7-8-9-10-11. PRESET STATION

A. To memorize the current frequency, press any one of the six preset buttons [1-6] on the front panel or on the remote controller hold for more than 2 seconds.

# BASIC OPERATION

- B. To recall the preset memory, press one of the preset buttons [1-6].  
C. Press **1/TOP(6)** button to select the first track/chapter to play.  
a. In the state of VCD/CD/MP3 disc playing, press the button on the front panel to select the first track/chapter to play. (depend on the disc used for VCD)  
b. In the state of DVD disc playing, the **1/TOP** button is not available.  
D. Long Press **2/RPT(7)** button to select repeat mode as follow.

DVD:



VCD/CD:



- a. Continuously repeat at the current chapter/track, when selected **REP-ONE** mode.  
b. Select **REP-ALL** mode to continuously repeat all chapter/track on the current disc.  
c. **REPEAT** feature does not support VCD2.0 (with PBC ON).  
E. Long Press **3/INT(8)** button to scan disc.  
a. In the state of CD disc playing, press the **3/INT** button to play the previous 6 seconds part of each track/chapter on disc.  
b. In the state of Mp3 disc playing, the **3/INT** button is not available.  
c. In the state of VCD disc playing, long press the **3/INT** button, the screen will display as follow (long press it again will release this mode.):

```
SELECT DIGEST TYPE:
TRACK DIGEST
DISC INTERVAL
TRACK INTERVAL
```

- 1). you can use the **▲/▼/▶/◀** buttons on the remote control to select the item, and then press the **ENTER** button to confirm .  
2). **In Track Digest OR Disc/Track Interval MODE.**  
You can use the **▲/▼/▶/◀** buttons to select the items, and then press the **ENTER** to confirm .  
You can also select the items using the corresponding number buttons, and then press the **ENTER** to confirm .  
d. In the state of DVD disc playing, long press the **3/INT** button, the screen will display as follow (long press it again will release this mode.):

```
SELECT DIGEST TYPE:
TITLE DIGEST
CHAPTER DIGEST
TITLE INTERVAL
CHAPTER INTERVAL
```

- 1). You can use the **▲/▼/▶/◀** buttons on the remote control to select the item, and then press the **ENTER** button to confirm .  
2). **In Title/Chapter Digest OR Title/Chapter Interval MODE.**  
You can use the **▲/▼/▶/◀** buttons to select the items, and then press the **ENTER** to confirm .  
You can also select the items using the corresponding number buttons, and then press the **ENTER** to confirm .  
F. Long Press **4/RDM(9)** to play disc in random.  
In the DVD/VCD/CD/MP3 disc playing, press the **4/RDM** button on the front panel to play in random (depend on the disc used for VCD).

# BASIC OPERATION

---

## 12. AS/PS BUTTON

When shortly pressing the APS button on the front panel or the A/P button on the remote controller, the radio searches for each preset station. When the field Strength level is more than the threshold level of stop level, the radio is holding at that preset number for few seconds with releasing mute, and then searches again. In FM band, FM 1, FM 2 and FM 3 is checked one at a time. When long pressing the APS or A/P button (more than 1 second), the radio searches from the current frequency and checks the signal strength level until 1 cycle search is finished. And then 6 strongest stations are preset to the corresponding preset number. The AS operation is implemented in the each band of selected band. When the AS operation is finished, the radio executes the preset scan.

## 13. MU BUTTON

Press it to mute down sound. Press it again to release this mode and recover previous volume level.



## 14. (ANGLE) BUTTON

Press it to change the view angle, you can adjust the angle for your desired



## 15. CLK BUTTON

Press it to change the display to clock display. Press it again to return to previous display. In clock display, press and hold for about 2 seconds until the hour display flashes. Face up or down swing the SEL Knob VOL+/- to adjust hours, press CLK button to flash minute then use VOL+ /VOL- to adjust minutes.

## 16. BUTTON



Pressing  during playback will stop play temporary. Return to normal playback, press  once again.



## 17. / BUTTONS

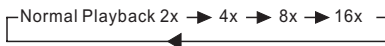

A. When face right or left swing the SEL knob  /  button (more than 2 seconds) during play. The speed of rapid forward/reverse changes according to the disc as follow.

DVD/VCD/CD/MP3:



B. Face right or left swing the SEL knob the  /  button during playback to skip to next track or back one track. (Note: In DVD mode, face left swing continually the SEL knob the  button twice during playback to skip back one track.)

Note: For some VCD 2.0 discs (PBC-playback control),  and  buttons may be unavailable.

C. Press UP or DN button on the remote controller or face right or left swing the SEL knob  /  on the front panel to manually tune up or down for your desired station. Press them hold for more than 2 seconds to automatically tune up or down for the stronger station.

## 18. MOD BUTTON

Press it repeatedly select TV, AUX IN, RADIO and DISC mode. In USB during playback, you can press STOP button and then press the GOTO button to select the DISC mode.

## 19. EJECT BUTTON

Press the eject button to turn downward the front panel and eject the disc from the disc compartment. Also you can insert the disc to the compartment.

# BASIC OPERATION

## 20. ST BUTTON

Press ST button to select STEREO or MONO reception for radio stations.

## 21. MENU BUTTON

Press it to display the root menu of the DVD/VCD(Only when PBC not in use) disc.

## 22. RESET BUTTON

RESET button is placed on the housing and must be activated with either a ballpoint pen or thin metal object. The RESET button is to be activated for the following reasons:

- A. Initial installation of the unit when all wiring is completed.
- B. All the function buttons do not operate.
- C. Error symbol on the display.

Note: If press RESET button, the unit can't work yet, please use a cotton swab soaked in isopropyl alcohol to clean the socket on the back of the front panel.

## 23. AUX INPUT JACK

When the unit connect external A/V, you can press MODE to switch the AUX input mode.

## MP3/WMA/JPEG DISC PLAY

1. When inserting an MP3/WMA/JPEG disc

Ex: When Mp3 file is detected.

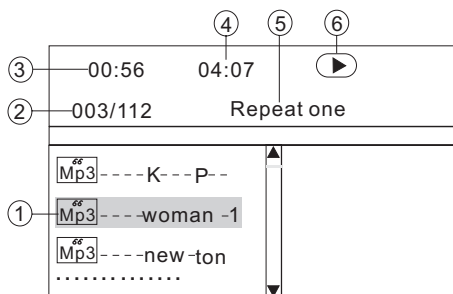

- ①. Current track(file)(highlighted bar)
- ②. Current track (file) number/total number of tracks(files) in the current folder.
- ③. Elapsed playing time of the current track(not available for JPEG disc)
- ④. total playing time.( not available for JPEG disc)
- ⑤. Selected playback mode
- ⑥. Operation mode icon. ▶ (Play), ■ (stop), || (pause), ►► (forward) ◀◀ (reverse).

In stop mode, use ▲/▼/▶/◀ on the remote control to select the item or folder, then press ENTER button to confirm.

Pressing REPEAT button repeatedly can select two kinds of repeat play mode.

2. REP-ONE:

Play the same song over and over again.

3. REP-ALL:

Play all songs in the discover and over again.

In the playback, use ►► or ◀◀ to skip an item ahead or back.

In the playback, face right or left swing the SEL knob ►►/◀◀ button (more than 2 seconds) on the front panel or short press ►►/◀◀ on the remote control to rapid forward/reverse.

# BASIC OPERATION

## TFT MONITOR OPERATION

1. Press the SEL button(3) repeatedly during DVD/VCD mode to display the adjustment items on the screen(24). and then face up or down swing the VOL+/- buttons to adjust the selected item. (The corresponding value will show on the display.)

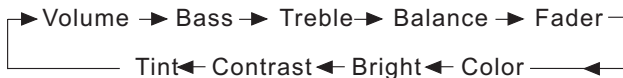

## 2.ADJUSTABLE ITEMS:

COLOR: 0 to 32

Adjust the color fo the picture-lighter or darker.

BRIGHT: 0 to 32

Adjust if the picture is too bright or too dark.

CONTRAST: 0 to 32

Adjust the contrast of the bright ans dark portion.

TINT: 0 to 32

Adjust the tint if the human skin color is unnatural.

-Adjustable when "NTSC " is selected for "NTSC/PAL " .

(The function of the VOLUME, BASS, TREBLE, BALANCE and FADER, Please see page 10.)

## REAR VIEW CAMERA

When connecting the rear view camera.the mirror image of the rear view through the rear view camera is automatically displayed on the monitor when you change the gear to the back position.(The monitor on the unit only.)

## NOTE(for the brake function)

if the parking brake is not engaged, "parking brake" flashes on the monitor, and no playback picture will be shown.only the audio will be heard.

-This warning appears only when the parking brake wire is connected to the parking brake system built in the car. (See page .7)

## MPEG4 DISC PLAY

MPEG4 disc is playing as the format of FILE . For example:

In stop mode , use ▲/▼/▶/◀ on the remote control to select the item , then press ENTER button to confirm. Pressing REPEAT button repeatedly can select three kinds of repeat play mode.

REP-ONE:

Play the same song over and over again.

REPEAT ALL:

Play all songs in the current directory in sequence, over and over again.

DISC REPEAT:

Play all songs in the discover and over again.

In the playback, use ▶▶ or ◀◀ to skip an item ahead or back.

In the playback, face right or left swing the SEL knob ▶▶ / ◀◀ button (more than 2 seconds ) on the front panel or short press ▶▶ / ◀◀ on the remote control to rapid forward/reverse.

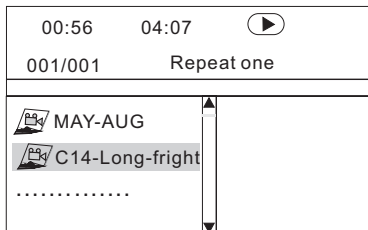

# BASIC OPERATION

## USB Operation

- A. Plug the USB connect line to the USB socket (see number 25) of the unit properly, (See fig.1) when the USB appliance connect to the USB port of the connect line, the system start playing track of the USB appliance automatically.
- B. IN USB playing , you can press the cursor button to select the item. Then press ENTER button to playing. also press numeric to play the corresponding track directly. Press the ►►/◄◄ button to skip to the next track or skip to the back one track Press the ►►/◄◄ button to fast forward or fast reverse.  
Press the REPEAT button to select repeat play mode.  
You can press the EJECT button to eject the disc or insert the disc into the compartment.  
When insert the disc, the unit will play the disc automatically .
- C. In USB mode (when the disc in the unit) Press the STOP button once , and then press the GOTO button, the unit will change the DISC mode to play, In DVD/VCD/CD mode,  
Press the STOP button twice, and then press the GOTO button, the unit will change the USB mode to play In MP3 mode,  
press the STOP button once, and then press the GOTO button, the unit will change the USB mode to play.

### Note:

- a: To prevent damage to the USB , during the playback don't pull out.  
b: In the state of the DISC playing , Best to pull out the USB.

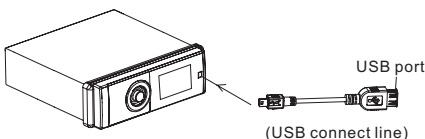

(Fig.1)

## On-Screen Display Function

Press the OSD button during playback to display the contents of the current disc on the screen.

A. Example for DVD:

a. Press OSD for the first time:

TITLE ELAPSED
TT 01/01 CH 01/38 0:02:06

Title Number, Total Title Number, Chapter Number, Total Chapter Number of this Title of the disc currently being played will be shown on the screen, along with the elapsed time.

b. Press OSD for the second time:

TITLE REMAIN
TT 01/01 CH 01/38 3:24:36

c. Press OSD for the third time:

CHAPTER ELAPSED
TT 01/01 CH 01/38 0:02:56

d. Press OSD for the fourth time:

CHAPTER REMAIN
TT 01/01 CH 01/38 0:04:32

e. Press OSD for the fifth time:

The message on the screen will be cleared.

B. Example for VCD/SVCD/CD:

a. Press OSD for the first time:

SINGLE ELAPSED
TRACK 01/16 00:49

b. Press OSD for the second time:

SINGLE REMAIN
TRACK 01/16 02:45

c. Press OSD for the third time:

TOTAL ELAPSED
TRACK 01/16 00:60

d. Press OSD for the fourth time:

TOTAL REMAIN
TRACK 01/16 78:46



# BASIC OPERATION

e. Press **OSD** for the fifth time:  
The message on the screen will be cleared for SVCD and VCD.  
C. Example for MP3:  
Each time OSD is pressed, the message displayed on screen changes as follows:



## Multi-audio Language Function

### For DVD:

Press **AUDIO** during playback.  
Each time the button is pressed, number of the audio soundtrack language changes on sequential order.

#### NOTES:

- The language number is different according to the disc.
- Some disc only contain one language soundtrack
- When no different language soundtrack are recorded, will be display at screen left top corner.

### For VCD/CD:

Press **AUDIO** during playback. It is possible to switch the sound between monaural and stereo sound.

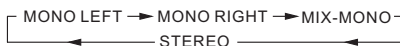

## Title Menu Function

### For DVD:

If the DVD has multiple titles recorded on the disc. It can select preferred title from the title menu to start playback.

- Press **TITLE** during playback. The title menu is display.
- Press the cursor button shown in TV screen, select preferred title by the cursor button and confirmed by **ENTER** key.

### For VCD:

Press **TITLE/PBC** button on the remote control while the disc is playing, you can switch between "PBC on" and "PBC off" mode.

## Multi-subtitle Language Function (for DVD Only)

Press **SUBTITLE** during playback.  
Each time the button is pressed, number of the subtitle language changes in sequential order.

#### Notes:

- The language number is different according to the disc.
- Some discs only contain one subtitle language.
- When no different subtitle language are recorded, will be displayed at screen left top corner.

## Multi-angle Function (for DVD Only)

Press **ANGLE** during playback. Each time the button is pressed, number of the angle changes in sequential order.

#### Notes:

- The angle number is different according to the disc.
- The function only work for disc having scenes recorded at different angles.
- When no different angle are recorded, will be displayed at screen left top corner.

## TV Operation

### Switching to TV mode

1. Connect the TV antenna to the TV.IN (from Ant) jack on the back of the unit.
2. Press the mode button on the remote control to select the TV mode.

### Auto searching TV channels

Press the **SEARCH** button on the remote controller to star search channel automatically.

### Selecting channel

- Press the **▲ / ▼** button to choose the channel upward and downward.
- The numeric button (0-9) allow you to select the corresponding channel directly.

#### Note:

In TV mode, the +10 button is not available.

### Fine TV channel

You can press **► / ◀** button on the remote controller to fine TV channel. It can be improve the picture quality .

### Channel ADD/DEL

In TV mode ,after search channel automatically, when you want delete the no sign channel, press the **SKIP** button (the screen display **SKIP**),the channel will be deleted. Also, you can press numeric button to select channel, then press **SKIP** to add channel(the screen display **SAVE**).

# SETUP

## GENERAL SETUP

--- GENERAL PAGE ---

----General setup page----	
TV Display	LB
Angle Mark	ON
OSD Lang	ENG
Spdif Output	SPDIF/RAW
Captions	ON
Screen Saver	ON
Last Memory	ON
Go To General Setup Page	

----General setup page----	
TV Display	Normal/PS
Angle Mark	Normal/LB
OSD Lang	Wide
Spdif Output	
Captions	
Screen Saver	
Last Memory	
Set TV Display Mode	

1. Press **SETUP** button on the remote control .
2. The **SETUP** menu is displayed.
3. Select the preferred item by using the **▶ / ◀ / ▼ / ▲** buttons
4. Press **ENTER** button.

### a. GENERAL SETUP

This setup page includes the item of TV display & audio output feature. The detail please refer to **GENERAL SETUP MENU**.

### b. SPEAKER SETUP

This is to activate the audio output from DOLBY AC3 5.1 DOWNMIX to 2 channel mode. Please refer to **SPEAKER SETUP MENU**.

### c. DOLBY DIGITAL SETUP

Please refer to **DOLBY DIGITAL SETUP**.

### d. PREFERENCE SETUP

This setup page includes all the configuration of support feature. The detail please refer to **PREFERENCES SETUP MENU**.

Video Material	TV Screen			
	Normal	Pan Scan	Letter-box	Wide(16:9)
4:3				
16:9				

## 1. TV DISPLAY SETUP

This is to select the appropriate TV aspect (4:3 or 16:9) according to the connected TV set.

### Normal/PS (For 4:3 TV)

Played back in the PAN & SCAN style. (If connected to wide-screen TV, the left and right edges are cut off.)

### Normal/LB (For 4:3 TV)

Played back in letterbox style. (If connected to wide-screen TV, black bands appear at top and bottom of the screen.)

### Wide (For 16:9 TV)

Select when a wide-screen TV set is connected.

# SETUP

-----General setup page-----

TV Display	
Angle Mark	ON
OSD Lang	OFF
Spdif Output	
Captions	
Screen Saver	
Last Memory	

Set Angle Mark

## 2. ANGLE MARK DISPLAY SETUP

If it is set to ON, when the multi-angle DVD disc is playing,  (the angle mark) will appear on the screen; if it is set to OFF, the mark will not appear.

-----General setup page-----

TV Display	
Angle Mark	
Osd Lang	
Spdif Output	SPDIF OFF
Captions	SPDIF/RAW
Screen Saver	SPDIF/PCM
Last Memory	

Setup SPDIF

## 4. SPDIF OUTPUT

This is to activate the audio output from SPDIF OFF mode to SPDIF/RAW mode to SPDIF/PCM mode.

-----General setup page-----

TV Display	
Angle Mark	English
OSD Lang	French
Spdif Output	German
Captions	Spanish
Screen Saver	Italian
Last Memory	Portuguese

Set OSD Language

## 3. OSD LANG TYPE SETUP

Select the preferred OSD language by using the ▲ / ▼ buttons.

-----General setup page-----

TV Display	
Angle Mark	
OSD Lang	
Spdif Output	ON
Captions	OFF
Screen Saver	
Last Memory	

Closed Caption

## 5. CAPTIONS SETUP

Activate the CAPTIONS feature by selecting ON. And release this feature by selecting OFF.

# SETUP

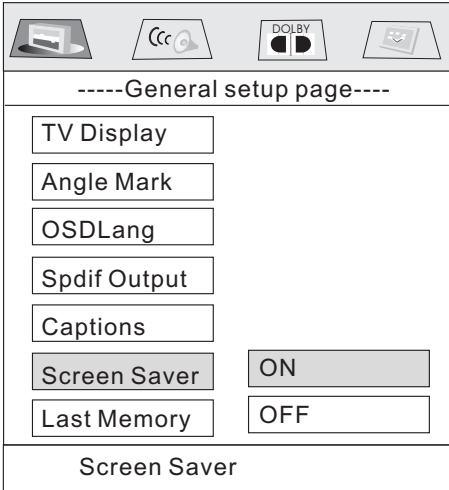

## 6. SCR SAVER SETUP

Select the SCR SAVER output ON/OFF.

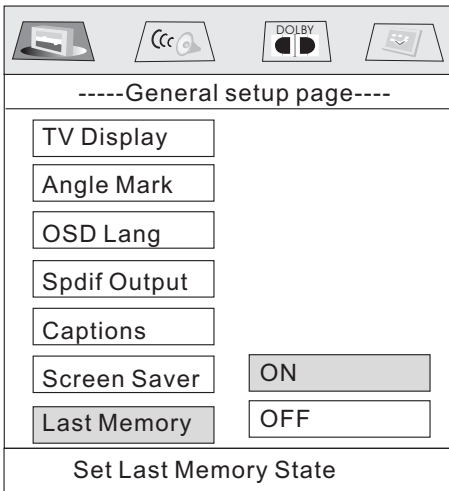

## 7. LAST MEMORY SETUP

Select the LAST MEMORY output ON/OFF.

## SPEAKER SETUP

--- SPEAKER SETUP PAGE ---

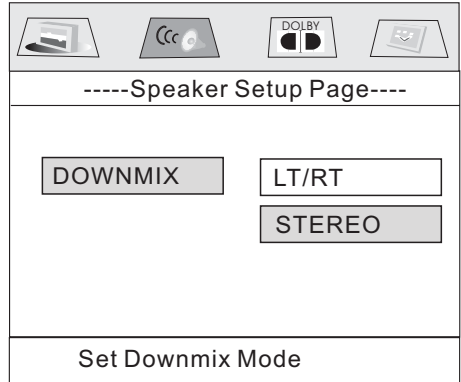

This is to activate the audio output from DOLBY AC3 5.1 DOWNMIX to 2 channel mode. Select the preferred SPEAKER connection by using the cursor buttons. Select the LT/RT to activate the Dolby surround compatible output. Select the STEREO to activate simple stereo mode.

## DOLBY DIGITAL SETUP

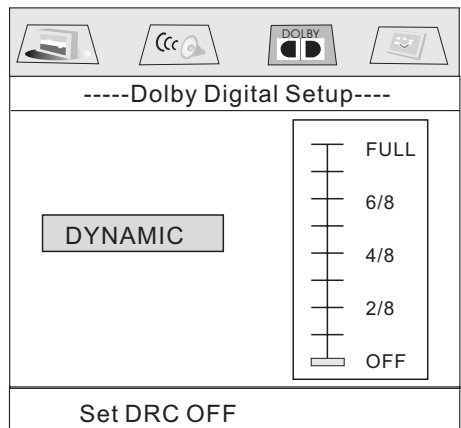

## DYNAMIC RANGE CONTROL

Select DRC and adjust the dynamic range of a Doby Digital encoded program. There are 8 steps between full compression and off compression.

# SETUP

## PREFERENCES SETUP

--- PREFERENCES PAGE ---

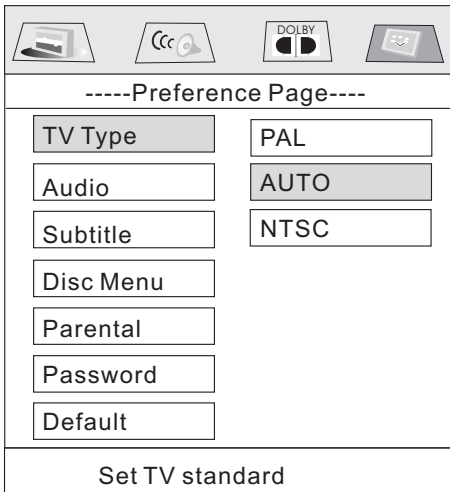

-----Preference Page-----

TV Type	PAL
Audio	AUTO
Subtitle	NTSC
Disc Menu	
Parental	
Password	
Default	

Set TV standard

### 1. TV TYPE SETUP

This player can play discs recorded in either PAL or NTSC format. Select NTSC format, when you connected to NTSC TV. Select PAL format, when you connected to PAL TV. Select AUTO format, the player TV output format will according to the DVD disc format..

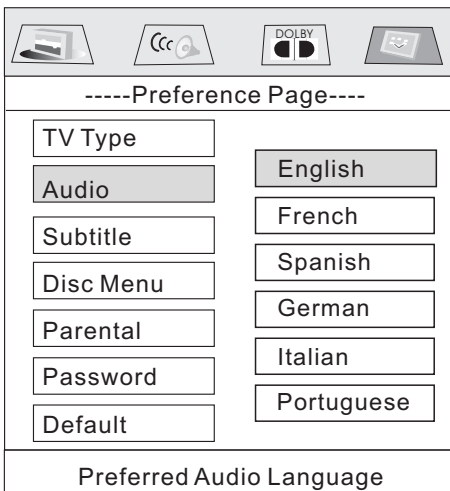

-----Preference Page-----

TV Type	
Audio	English
Subtitle	French
Disc Menu	Spanish
Parental	German
Password	Italian
Default	Portuguese

Preferred Audio Language

### 2. AUDIO LANGUAGE SETUP

Select the preferred AUDIO sound-track by using the cursor buttons.

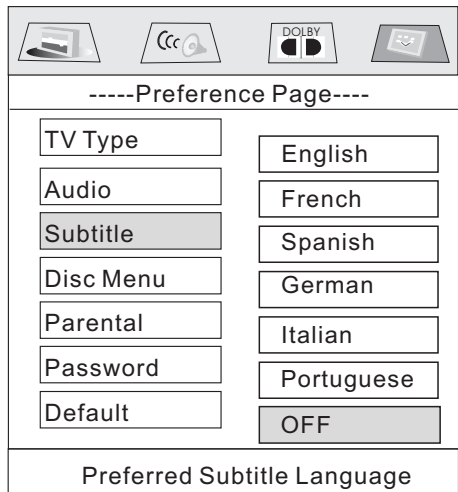

-----Preference Page-----

TV Type	English
Audio	French
Subtitle	Spanish
Disc Menu	German
Parental	Italian
Password	Portuguese
Default	OFF

Preferred Subtitle Language

### 3. SUBTITLE LANGUAGE SETUP

Select the preferred SUBTITLE language by using the cursor buttons.



-----Preference Page-----

TV Type	
Audio	English
Subtitle	French
Disc Menu	Spanish
Parental	German
Password	Italian
Default	Portuguese

Preferred Menu Language

### 4. DISC MENU LANGUAGE SETUP

Select the preferred DISC MENU language by using the cursor buttons.

# SETUP

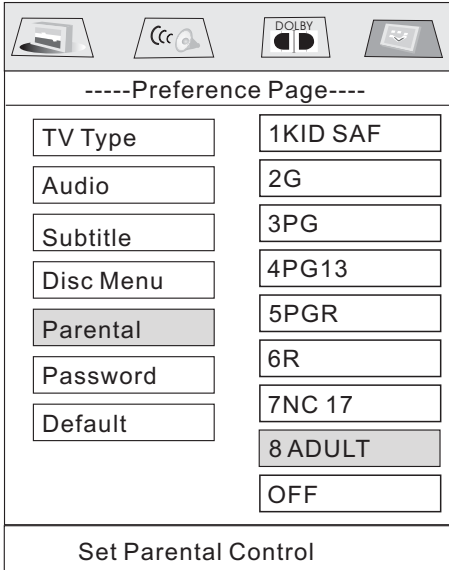

-----Preference Page-----

TV Type	1KID SAF
Audio	2G
Subtitle	3PG
Disc Menu	4PG13
Parental	5PGR
Password	6R
Default	7NC 17
	8 ADULT
	OFF

Set Parental Control

## 5. PARENTAL

Select suitable parental guidance by the cursor buttons and conformed by pressing ENTER button.

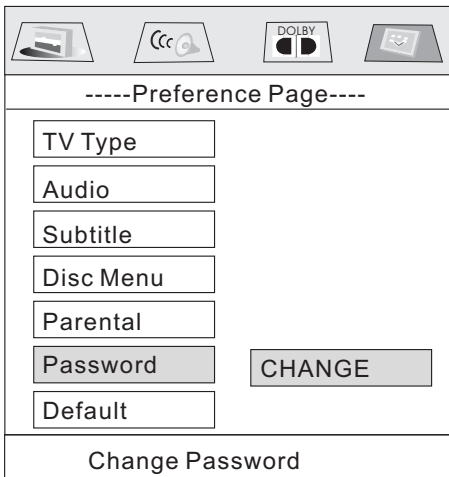

-----Preference Page-----

TV Type	
Audio	
Subtitle	
Disc Menu	
Parental	
Password	CHANGE
Default	

Change Password

## 6. PASSWORD

Select the change and press ENTER button. Type the old password (The initial factory code is **1379**) and key in 4 characters password now you want to use, and retype again to confirm key in correctly.

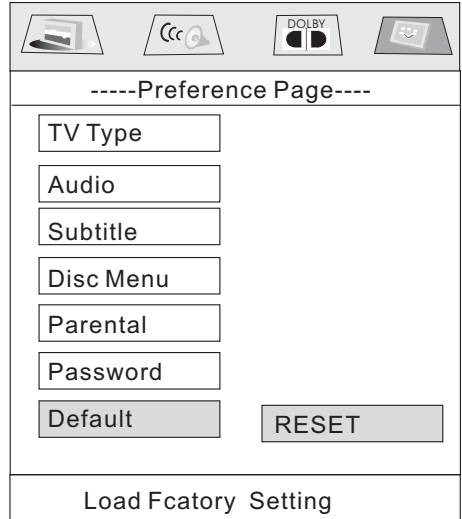

-----Preference Page-----

TV Type	
Audio	
Subtitle	
Disc Menu	
Parental	
Password	
Default	RESET

Load Factory Setting

## 7. DEFAULTS

Select reset to become factory initial setting.

## DEFAULTS TABLE

GENERAL SETUP	TV DISPLAY	NORMAL/LB
	ANGLE MARK	ON
	OSD LANGUAGE	ENGLISH
	SPDIF OUPUT	SPDIF/RAM
	CAPTIONS	ON
	SCR SAVER	ON
	LAST MEMORY	ON
SPEAKER SETUP	DOWNMIX	STEREO
DOLBY DIGITAL	DYNAMIC	OFF
PREFERENCES	TV TYPE	AUTO
	AUDIO	ENGLISH
	SUBTITLE	OFF
	DISC MENU	ENGLISH
	PARENTAL	8 ADULT
	PASSWORD	1379

# SPECIFICATION

---

## GENERAL

Supply Voltage : 12v Dc (11v-15v)

Current Consumption : More Than 10 A

**SIGNAL SYSTEM** : Compositive Video 1.0vp-p 75Ω

## DISCS PLAYED

(1) Dvd-video Disc

5"(12 Cm) Single-sided, Single-layer

5"(12 Cm) Single-sided, Double-layer

(2) Compact Disc (cd-da, Video Cd)

5"(12cm) Disc

## AUDIO SIGNAL OUTPUT CHARACTERISTICS

: 2ch&4ch Line Out

(1) Frequency Response 20 Hz - 20 Khz

(2) S/n Ratio 90 Db (jis)

(3) Wow And Flutter

Below Measurable Limits

## RADIO

### FM TUNER SECTION

Tuning Range : 87.5-107.9MHz

IF Range : 10.7MHz

Usable sensitivity(30dB) : 15dB

### AM TUNER SECTION

Frequency Range : 530-1710KHz

IF Range : 450KHz

Usable sensitivity(30dB) : 45dB

## TV TUNER

TV System : NTSC or PAL

TV Sensitivity : 45dBμV @CH25 in average

## TFT MONITOR

Monitor Screen Size : 2.5 Inch Wide

Number of Pixels : 480 X 234 pixes

Color System : NTSC/PAL

## NOTE:

Specifications and design are subject to modification, without notice, due to improvements in technology.

# TROUBLE SHOOTING

Before going through the check list, check wiring connection. If any of the problems persist after check list has been made, consult your nearest service dealer.

SYMPTOM	CAUSE	SOLUTION
No power	The car ignition switch is not on	If the power supply is properly connected to the car accessory terminal, switch the ignition key to "ACC"
	The fuse is blown	Replace the fuse
Disc can not be loaded or ejected	Presence of disc inside the player.	Remove the disc in the player, then put a new one
	Inserting the disc in reverse direction	Insert the compact disc with the label facing upward
	The disc is extremely dirty or defective	Clean the disc or try to play a new one
	Temperature inside the car is too high	Cool off or until the ambient temperature return to normal
Television/video image appears black-white	The color system is set incorrectly	Please switch to correct color system from menu
No television/video image appears	The unit is not connected to the parking brake detection switch	Make proper connection according to "wire connection"
	The parking brake is not engaged	For safety reasons no television /video images are displayed while the vehicle is moving. Engaging the parking brake will cause images to be displayed.
No color in picture	The disc format is not according to the TV-set used (PAL/NTSC)	Please the television mode of the choice accommodation
JPEG disc can not be played back	No JPEG files are recorded on the disc.	Change the disc
	JPEG files are not recorded in a compliant format	Change the disc Record JPEG files using a compliant application
The operation keys do not work	The built-in microcomputer is not operating properly due to noise	Press the RESET button. Front panel is not properly fixed into its place
The radio does not work	The antenna cable is not connected	Insert the antenna cable firmly
	The signals are too weak	Select a station manually



## Free Manuals Download Website

<http://myh66.com>

<http://usermanuals.us>

<http://www.somanuals.com>

<http://www.4manuals.cc>

<http://www.manual-lib.com>

<http://www.404manual.com>

<http://www.luxmanual.com>

<http://aubethermostatmanual.com>

Golf course search by state

<http://golfingnear.com>

Email search by domain

<http://emailbydomain.com>

Auto manuals search

<http://auto.somanuals.com>

TV manuals search

<http://tv.somanuals.com>