

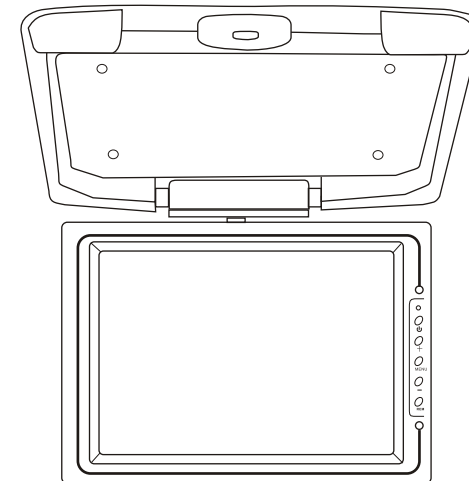

PYLE® view

INSTRUCTION MANUAL



PLVWR910R

8.8 ROOF MOUNT TFT LCD MONITOR

**WARNING: DO NOT WATCH WHILE VEHICLE IN MOTION,
IT CAN BE HAZARDOUS**



Congratulations on your purchase of our 8.8 inch TFT LCD monitor.

This monitor has been built to deliver the highest quality video reproduction.

We are sure you`ll enjoy watching your favorite movies with this component as a part of your multimedia.

For best please consult a professional mobile electronics installer for application advice or troubleshooting.

SPECIFICATIONS

Screen size: 8.8inch
System: PAL&NTSC
Display Method:..... TFT Active matrix system
Display ratio:..... 4:3
Power supply:..... DC 12V
Power consumption:..... 10W
Weight:..... 900g

ACCESSORIES

Metal mounting plate Mounting screws Remote controller
6 pin din cable Instruction manual

1. Power indicator

It turns on when power is connected

2. Power On/Off

Press it to turn on/off the monitor

3. +: Positive adjustment

Press it to adjust the values positively.

4. MENU: active menu

Press it to active the menu, it shows

VOLUME-BRIGHTNESS-CONTRAST-SATURATION-HUE-SOURCE INPUT-AV INVERSE-AV MIRROR

5. -: Negative adjustment

Press it to adjust the values negatively.

6. REM: IR sensor

7. Dome lights

















8. Monitor release button

Press it to release the monitor.

9. Dome light switch

Press it to turn On/Off the dome lights.

REMOTE CONTROL

-  Power On/Off the monitor
-  Brightness negative adjustment
-  Brightness positive adjustment
-  Contrast negative adjustment
-  Contrast positive adjustment
-  Saturation negative adjustment
-  Saturation positive adjustment
-  Negative adjustment
-  Active the OSD menu and shows CONTRAST-BRIGHTNESS-SATURATION-HUE-VOLUME-SOURCE V1 OR V2
-  Positive adjustment
-  No use
-  No use
-  Switch between V1 and V2
-  No use
-  Only Shown on the screen menu but without function
-  Volume negative adjustment
-  Volume positive adjustment



Thank you for the purchase of this roof mounting 8.8 inch TFT-LCD monitor. Before operating the unit, please read this manual thoroughly and keep it for future reference.

PREAUTIONS

The set is for use in DC 12V, negative ground vehicles.

Do not operate the set in ways other than described in this guide. Doing so may damage it and may void your warranty.

SAFETY FIRST! FOR REAR SEAT USE ONLY. Do not install on dashboard or anywhere else that would permit monitor to be viewed by the driver. Monitor must never be used in any manner that will distract driver or interfere with the driver's safe operation of the motor vehicle.

Be careful not to run down the car battery while using the set with the car stopped.

Do not disassemble or modify the set. Doing so may damage it and voids your warranty.

Keep drinks and drops from umbrellas away from the set. Water may damage the internal circuitry.

Do not let the set become hot. If temperature in the car is high or the set has been exposed to direct sunlight and is hot, lower the temperature before using it.

In extremely cold temperatures, the movement of the picture may be slow and the picture may be dark, but this is not a malfunction. The set will work normally once the temperature increases.

Small Black and shiny dots inside the liquid crystal panel are normal for liquid crystal product.

Front panel

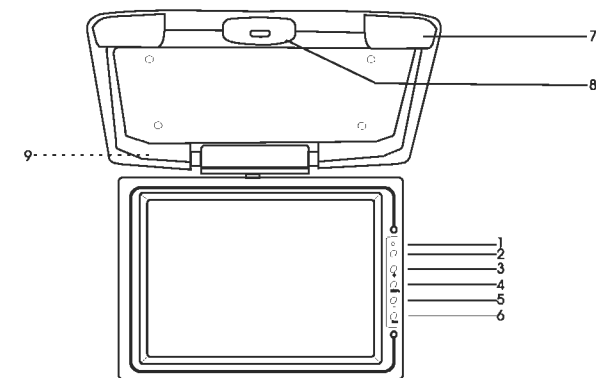

Contents and specifications can be subject to change without prior notice.

REMOTE CONTROL BATTERY

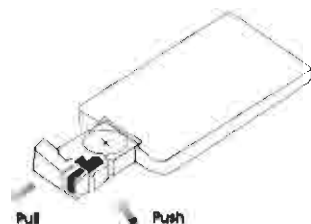

1. Always use new batteries when replacing the old set.
2. Do not attempt to charge, short-circuit, disassemble, heat or burn used batteries.
3. Battery replacement is necessary when remote control acts sporadically or stops operating this device.
4. Do not place objects between the remote control and remote receiver.
5. If the Monitor does not operate even when operating the remote control from a close range, it is time to replace the batteries (Product number: (cr2025).

INSTALLATION

The device is an overhead, fold-down 8.8 inch monitor with an Infrared IR eye. It will accept a video signal from any video source with composite video out.

1. look over the vehicle for a location for the monitor. Each vehicle is different And locations will vary. Make sure the monitor will not interfere with the Driver.
2. once a location has been determined, connect the IR, A/V RCA's end Power cables to the designated sources.
3. Feed the cables through the hole in the mounting bracket and screw the bracket to the headliner. Use short screws so as not to damage the roof.
4. Plug the cable into the monitor's 6 Pin Din connector. Mount the monitor with the provided hardware.

WIRING

Read all wiring precautions. If you are not sure of the connections, contact your authorized dealer.

1. Disconnect the negative (-) lead of the battery before making any power connections.
2. When creating passage holes for the power wires, use grommets to eliminate any sharp edges created during drilling. This will protect the wire from being nicked and causing a short circuit.
3. When connecting the ground lead, fasten the ground lead (black) securely to a clean metal plate on the vehicle.

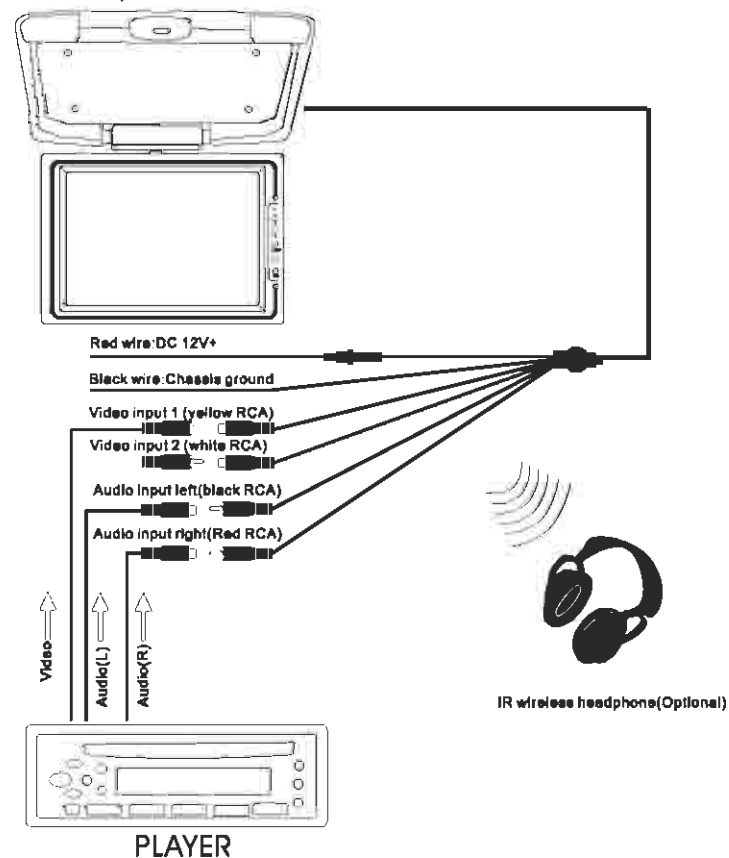

Free Manuals Download Website

<http://myh66.com>

<http://usermanuals.us>

<http://www.somanuals.com>

<http://www.4manuals.cc>

<http://www.manual-lib.com>

<http://www.404manual.com>

<http://www.luxmanual.com>

<http://aubethermostatmanual.com>

Golf course search by state

<http://golfingnear.com>

Email search by domain

<http://emailbydomain.com>

Auto manuals search

<http://auto.somanuals.com>

TV manuals search

<http://tv.somanuals.com>