

# PYLE®

OWNER'S MANUAL

# PYLE®

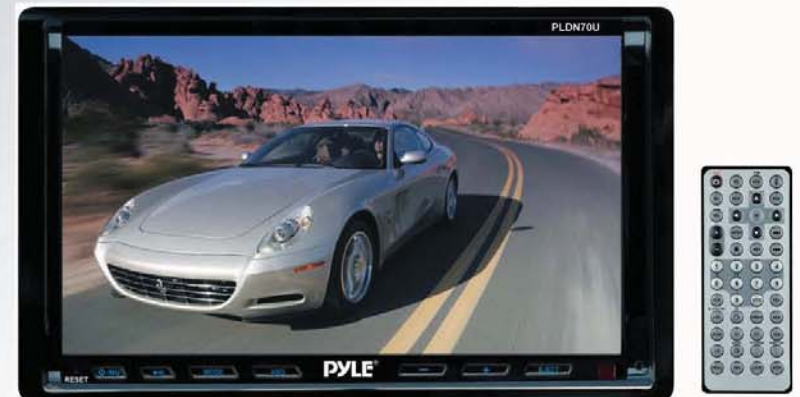

**PLDN70U**

[www.pyleaudio.com](http://www.pyleaudio.com)

7" Double DIN TFT Touch Screen  
DVD/VCD/CD/MP3/MP4/CD-R  
USB/SD-MMC Card Slot/AM/FM

## PRECAUTION

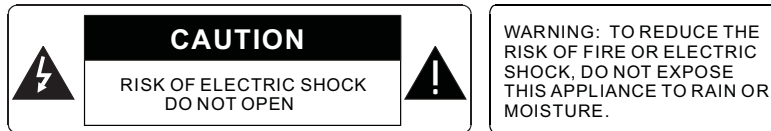

WARNING: TO REDUCE THE RISK OF FIRE OR ELECTRIC SHOCK, DO NOT EXPOSE THIS APPLIANCE TO RAIN OR MOISTURE.

CAUTION: TO REDUCE THE RISK OF ELECTRIC SHOCK, DO NOT REMOVE COVER (OR BACK). NO USER SERVICEABLE PARTS INSIDE. REFER SERVICING TO QUALIFIED SERVICE PERSONNEL.

 The lightening flash with arrowhead symbol, within an equilateral triangle, is intended to alert the user to the presence of uninsulated dangerous voltage within the products enclosure that may be of sufficient magnitude to constitute a risk of electric shock to persons.

 The exclamation point within an equilateral triangle is intended to alert user to the presence of important operating and maintenance (servicing) instructions in the literature accompanying the appliance.

### CLASS 1 LASER PRODUCT

Laser product symbol: located on the rear panel of the unit, indicate this player is a class laser product, only use weak laser and no hazardous radiation outside of the unit.

1. Read through this instruction manual before installation and use.
2. Do not touch the power plug with wet hand.
3. Switch off the main power when the unit is not in use. (Disconnect the power plug from the power outlet when you do not intend to use the unit for a prolonged period of time.) Before moving the unit, remove the disc from the unit/ tray first.
4. Do not open the cover or touch any of the components exposed out of the unit, only for qualified technicians.
5. Do not expose the unit under direct sunlight or nearby objects that radiate heat to avoid damage the unit.
6. Do not place the unit in moist and humid conditions, which effect the pick-up of the unit lead to out of work.
7. Place the unit on a flat surface and ventilative condition. Please ensure the ventilation holes are not covered to avoid overheating and malfunction.
8. Clear the panel and case with soft dry cloth only, do not apply any kind of thinner, alcohol or sprays.
9. The apparatus shall not be exposed to dripping or splashing and that no objects filled with liquids, such as vases, shall be placed on the apparatus .

## 6. Specification

### General Specification

Power Supply Requirement.....DC 12V  
 Maximum Power Output.....4 x 80W(measured at DC 14.4 V)  
 Dimensions(w x h x d).....178 x 50.5 x 162mm

### DVD Deck Specification

Format.....DVD/VCD/JPEG/MP4/MP3/WMA/CD  
 Video System.....NTSC/PAL/PAL-M/PAL-N/AUTO(optional)  
 Audio System.....24 bit/96KHz  
 Loading System.....Auto Loading  
 Mounting Angle.....0 to +/-30

### Video Specification

Video Type.....16:9 and 4:3  
 Video Output level.....Composite:1.0± 0.2Vp-p  
 Load impedance: 75 ohms  
 Horizontal Resolution.....500

### Audio Specification

Audio Output(Analog audio).....2.0<sup>+0</sup><sub>-1.0</sub> Vrms  
 Frequency Response.....20Hz ~ 20KHz(at 1KHz 0 dB)  
 S/N Ratio(Audio).....≥90dB(at 1KHz 0 dB)  
 Separation.....50dB

### Radio Specification

FM Section  
 Frequency range.....87.5MHz - 107.9MHz  
 Usable sensitivity.....3uV  
 I.F Frequency.....10.7MHz

### AM Section

Frequency.....530KHz - 1710KHz

## Contents

1. Before Operation.....	3
1.1 Glossary.....	3
1.2 Precautions.....	3
1.3 Maintenance and Cleaning of Discs.....	4
1.4 Battery Information of the Remote Control.....	4
1.5 The Remote Control Description.....	5
1.6 The Locations and Names of Controls on or in the unit.....	6
1.7 Wires Connection Description.....	7
1.8 Unit Installation.....	8
2. Common Operation.....	9
3. Radio Operation.....	10
4. Disc, USB and Card Operation.....	11
4.1 Load/unload Disc, USB or Card.....	11
4.2 Pause Playback.....	13
4.3 Stop Playback.....	13
4.4 Select Chapter/Track with the >> / << Buttons.....	13
4.5 Select Chapter/Track with the Number Buttons.....	13
4.6 Select Chapter/Track with the Root/PBC Menu.....	13
4.7 Playback with Speed.....	14
4.8 Playback with Slow Speed.....	14
4.9 Display Still Frame Step by Step.....	15
4.10 Playback Repeatedly.....	15
4.10.1 One/All Repeat.....	15
4.10.2 A-B Repeat.....	15
4.11 Playback in Scan Mode.....	16
4.12 Playback from a specified Chapter/Track or a Specified Time.....	16
4.13 Playback in Random.....	16
4.14 Playback in Different View-Angle.....	16
4.15 Playback in Zoom Mode.....	16
4.16 Change the Caption Language.....	17
4.17 Change the Audio Language.....	17
4.18 Change the Video Signal System.....	17
4.19 Look over the Playback Status.....	17
4.20 Program Playback.....	18
4.21 Playback IMAGE files.....	18
4.22 Playback MP4 files.....	19
4.23 ESP and ID3 Function.....	19
4.24 The DVD System Menu Setup Operation.....	19
* The Region Code.....	23
5. The Trouble Shooting.....	24
6. Specification.....	25

## 1. Before Operation

### 1.1 Glossary

#### PBC (playback control)

It is a kind of signal(menu) recorded in the disc with SVCD or VCD2.0 format used for the playback control. For the discs contained PBC, It can playback interactive software with the menu displayed on monitor screen. If the disc contain still images, it can playback high definition of still image.

#### Title

Generally, the title is the important part of DVD disc. for example, the theme part of movie is title 1, the part described how to make movie is title 2, the cast is title 3, etc. Every title contain a serial number that is easy to look up.

#### Chapter

A title can be divided into several blocks, so that every block can be operated as a unit, the unit is called chapter. The chapter contain a unit at least.

#### Track

It is the biggest component of VCD. Generally, every song of karaoke disc is a track.

## 1.2 Precautions

### Safety

1. Power Source: The unit should be connected to power supply only of the type described in the operating instructions or as marked on the unit.
2. The unit is designed for negative terminal of the battery which is connected to the vehicle metal. Please confirm it before installation.
3. Do not allow the speaker wires to be shorted together when the unit is switched on. Otherwise it may overload or burn out the power amplifier.
4. Do not install the detachable panel before connecting the wire.

### Environment

1. Do not use this unit when water and moisture is near it.
2. If moisture forms inside the Lens, it may not operate properly. To correct this problem, wait about one hour for the moisture to evaporate.
3. If the car interior is extremely hot, do not use the player until the car has been driven for a while to cool off the interior.

## 5. The Trouble Shooting

Please read the user's manual carefully before using the DVD player. If you have any troubles in using this player, try to solve the problems by the suggestions mentioned below. If you can not remove the trouble after using all the suggestions, please contact the company or the technical service center authorized by us. For the sake of your safety, please do not open the cover and repair the player by yourself, if that, it may cause electric shock.

### NO PICTURE, SOUND AND INDICATION

- \* Ensure that the power switch is on.
- \* Ensure that the wall inlet is ok.
- \* Ensure that the power cord is not damaged or the fuse is not blown.
- \* Ensure that the power plug is connected to the inlet tightly.

### NO SOUND BUT HAVE PICTURE

- \* Ensure that the player's audio output has a good connection with monitor's audio input.
- \* Check whether the audio connector is damaged.
- \* Check whether you have turned down the volume.
- \* Ensure that you have set the right AUDIO setup of the player.
- \* Ensure that the audio is not under mute.

### NO PICTURE BUT HAVE SOUND

- \* Ensure that the player's video output has a good connection with monitor's video input.
- \* Ensure that you have turned your monitor to the AV input channel connecting to your player.
- \* Check whether the video connector is damaged.
- \* Ensure that you have set the right VIDEO settings of the player.

### BLACK AND WHITE PICTURE OR SCREEN ROLLING

- \* Ensure that you have set the right TV SYSTEM (e.g. PAL, NTSC) setting.

### FLAWS OF PICTURE OR SOUND

- \* Check whether the setting of AUDIO is right.
- \* Check whether the disc is scratched or stained.
- \* Check whether the AV connector and the output terminal is stained.
- \* Check whether there is condensation inside the Lens. If so, leave the player off for an hour or so, then try again.
- \* Check whether the installation angle is less than 30° .

### DISPLAY NO DISC OR BAD DISC

- \* Ensure that you have put the disc on the tray.
- \* Check whether the disc is put in the reverse side.
- \* Check whether the disc is distorted.
- \* Check whether the disc is stained or scratched badly.
- \* Ensure that the disc format is compatible to the player.
- \* Ensure that the temperature inside the car is not too high. If so, cool off till the ambient temperature returns to normal.
- \* Replace another disc to insert it into the disc compartment.

### REMOTE CONTROL IS INSENSITIVE OR DOES NOT WORK

- \* Check the batteries of remote control and make sure that they are to be powerful and good conductivity.
- \* Direct the remote control to the IR sensor of the player.
- \* Check whether there are some obstacles between the remote control and IR sensor.

### SOME FUNCTION BUTTONS DO NOT WORK

- \* Turn off the power, then turn on again.
- \* Reset the unit to zero, then turn on again.
- \* Remove the front panel from the unit, then install it again and then turn on again.

### THE RADIO DOES NOT WORK

- \* Check whether the antenna cable is connected firmly. Or manually tune for a station.

### \* The Region Code

Q: Not begin to playback but to display REGION ERROR after inserting disc into disc compartment. Why ?

A: Because the DVD player and disc has respective region code. If the region codes of them are not match with each other, the DVD player can not play the disc.

Appendix: The region code of DVD:

The Motion Picture Association of America (MPAA) divided the world into 6 regions, and named every region a code, namely region code. The region codes and the countries or areas represented by the region codes as follows:

Region 1: America, Canada, East-Pacific Inlands;

Region 2: Japan, West Europe, North Europe, Egypt, South Africa, Middle East;

Region 3: South-east Asian countries include Taiwan, Hong Kong, South Korea, Thailand, Indonesia, etc.;

Region 4: Australia, New Zealand, Central South America, South Pacific Inlands;

Region 5: Russia, Mongolia, Indian Peninsula, Middle Asia, East Europe, North Korea, North Africa, North-west Asia etc.;

Region 6: China mainland.

Basically, when a DVD movie disc for the version of region 6 was decided not to issue, we need to purchase another DVD player that can play the DVD movie disc for the version of non-region 6. In order to view this disc, viewer who does not have the non-region 6 DVD player facilities will have to spend extra sum of money to buy it. The problems caused from the area code inconsistency between the disc and the DVD player has pushed for the production of Unlock-Version DVD player facilities, and some DVD disc sets allow user to modify the area codes for a limited number of times. But note that only the discs produced by the 8 biggest filmmaking companies of America restrict so, they are not one of original DVD format. That is to say, the DVD movie discs not produced by the 8 biggest filmmaking companies of America were not restricted by the rule of region code. Generally, they are called FreeRegionCode discs or Full Region discs. The 8 biggest filmmaking companies of America are as follows:

1. WarnerBros;
2. Columbia;
3. 20thCenturyFOX;
4. Paramount;
5. Universal;
6. UA(UnitedArtist);
7. MGM(MetroDogwynMayer);
8. WaltDisney

### 1.3 Maintenance and Cleaning of Discs

#### Disc Maintenance

1. To keep the disc clean, handle the disc by its edge, do not touch the disc surface of the play side.
2. Do not stick paper or tape on the disc. If there is glue (or analog) on the disc surface, must wipe it up before using.
3. Do not expose the disc to direct sunlight, or nearby heat sources such as caliduct, or leave it in a car parked in direct sunlight where there can be a considerable rise in temperature.
4. Put the disc inside disc case to keep temperature after finishing playback.

#### Disc Cleaning

1. Before playing, wipe the disc with a clean lint. wipe the disc outwards from the disc center.
2. Do not use petrol, thinner, commercially cleaner or anti-static spray can damage the unit.

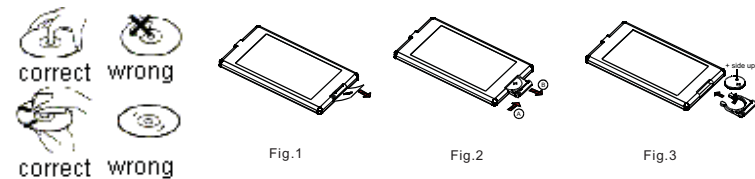

### 1.4 Battery Information of the Remote Control

#### Replace Battery in the Remote Control:

1. Before using the remote control for the first time, pull the insulating sheet out of the remote control as the direction indicated by the arrow.(see fig.1)
2. Press the movable block hold as the direction indicated by the A arrow (See fig.2), then pull the battery holder out of the remote control as the direction indicated by the B arrow(see fig.2).
3. Replace the old battery by a new battery with (+) polarity side upward. (See fig.3).
4. Insert the battery holder to the original position in remote control. (See fig.3).

#### Note about the Battery of the Remote Control:

1. Improper use of battery may cause overheating or explosion. so that Result in injury or fire .
2. Battery leakage may cause damage to the remote control(Battery Life: 6 months with normal use in normal room temperature).
3. Do not short the battery.
4. Do not throw the battery into the fire.
5. To avoid the risk of accident, keep the battery out of reach of children.

## 1.5 The Remote Control Description

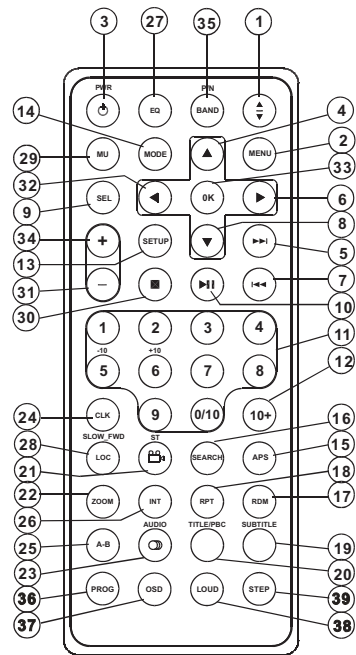

- |                                      |                         |
|--------------------------------------|-------------------------|
| 1. TILT BUTTON                       | 16. SEARCH BUTTON       |
| 2. MENU BUTTON                       | 17. RDM BUTTON          |
| 3. POWER BUTTON                      | 18. RPT BUTTON          |
| 4. ^ BUTTON                          | 19. SUBTITLE BUTTON     |
| 5. >>  BUTTON                        | 20. TITLE/PBC BUTTON    |
| 6. > BUTTON                          | 21. ANGLE/ST BUTTON     |
| 7.  << BUTTON                        | 22. ZOOM BUTTON         |
| 8. v BUTTON                          | 23. AUDIO BUTTON        |
| 9. SEL BUTTON                        | 24. CLK BUTTON          |
| 10. PLAY/PAUSE BUTTON                | 25. A-B BUTTON          |
| 11. NUMBER(0~10, +10<br>-10) BUTTONS | 26. INT BUTTON          |
| 12. 10+ BUTTON                       | 27. EQ BUTTON           |
| 13. SETUP BUTTON                     | 28. LOC/SLOW-FWD BUTTON |
| 14. MODE BUTTON                      | 29. MUTE BUTTON         |
| 15. APS BUTTON                       | 30. STOP BUTTON         |
| 16. SEARCH BUTTON                    | 31. VOLUME- BUTTON      |
| 17. RDM BUTTON                       | 32. < BUTTON            |
| 18. RPT BUTTON                       | 33. OK BUTTON           |
| 19. SUBTITLE BUTTON                  | 34. VOLUME+ BUTTON      |
| 20. TITLE/PBC BUTTON                 | 35. BAND AND P/N BUTTON |
| 21. ANGLE/ST BUTTON                  | 36. PROG BUTTON         |
| 22. ZOOM BUTTON                      | 37. OSD BUTTON          |
| 23. AUDIO BUTTON                     | 38. LOUD BUTTON         |
| 24. CLK BUTTON                       | 39. STEP BUTTON         |
| 25. A-B BUTTON                       |                         |
| 26. INT BUTTON                       |                         |
| 27. EQ BUTTON                        |                         |

### HUE

It is for adjusting the hue of the video output.

### SATURATION

It is for adjusting the saturation of the video output.

### SHARPNESS

It is for adjusting the sharpness of the video output.

#### 4.24.5 SPEAKER SETUP



### DOWNMIX

It is for selecting your desired sound effect when there is not central speaker and sub-woofer. There are 3 mode: LT/RT, STEREO, VSS.

LT/RT: When playing a disc with PRO LOGIC Dolby stereo effect, choose the item, so it will output audio signal with vivid theatre effect.

STEREO: If you choose the item, when outputting audio signal with 5.1 channels, it will output the left and right channels of signal ; when outputting audio signal with 2 channels, it will output the common 2 channels of stereo signal.

VSS: If you choose the item, when playing a disc recorded with 5.1 channels, the main channel speakers can output audio signal with VSS effect.

#### 4.24.6 DIGITAL SETUP



### OP MODE

It is for selecting audio output mode

LINE OUT: It can linearly compress the audio signal. So the volume level is lower. You should select the item at night.

RF REMOD: It can make the volume level higher. You should select it at daylight.

### DYNAMIC RANGE

After selecting the compression mode of LINE OUT, set the item, so you can adjust the linear compression ratio. If you set it to be FULL, the Peak-to-Peak value of the audio signal is the minimum; if you set it to be OFF, the Peak-to-Peak value is the maximum.

### DUAL MONO

It is for selecting a desired audio output mode for the left and right ways of signal.

It is mainly for Karaoke of Ac3. There are 4 modes in all as follows:

STEREO, MONO L, MONO R, MIX MONO.

#### 4.24.2 LANGUAGE SETUP

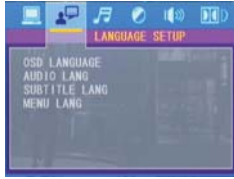

##### OSD LANGUAGE

This item is for selecting the language of the SYSTEM MENU and all operating prompt interface displayed during playback.

##### AUDIO LANG

This item is for selecting a audio language.

##### SUBTITLE LANG

This item is for selecting a subtitle language.

##### MENU LANG

This item is for selecting a disc menu language.

#### 4.24.3 AUDIO SETUP

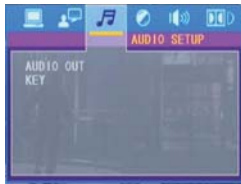

##### AUDIO OUT

there is only ANALOG mode, i.e. SPDIF/OFF, not optional.

##### KEY

It is for selecting your desired basic music tone(from low to high).

#### 4.24.4 VIDEO SETUP

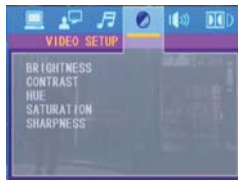

##### BRIGHTNESS

It is for adjusting the brightness of the video output.

##### CONTRAST

It is for adjusting the contrast of the video output.

#### 1.6 The Locations and Names of Controls on or in the unit

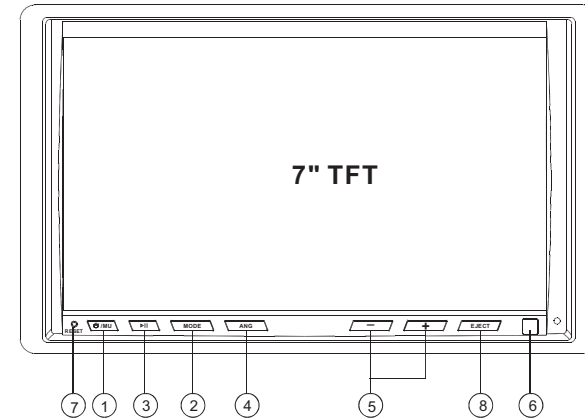

The Diagram of the Face of the Front Panel

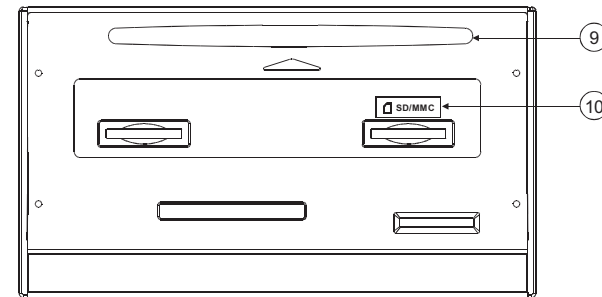

The Diagram of the Face of the Unit After Sliding down the Front Panel

- |                      |                      |
|----------------------|----------------------|
| 1. POWER/MUTE button | 6. IR remote sensor  |
| 2. MODE button       | 7. RESET button      |
| 3. PLAY/PAUSE button | 8. EJECT button      |
| 4. ANG button        | 9. Disc slot         |
| 5. + and - buttons   | 10. SD/MMC Card slot |

## 1.7 Wires Connection Description

### The Description of the Input/Output Interface of the Rear Cabinet

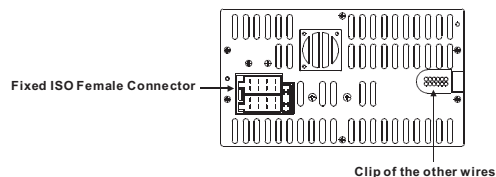

### The Description of the Other Wires Through the Clip

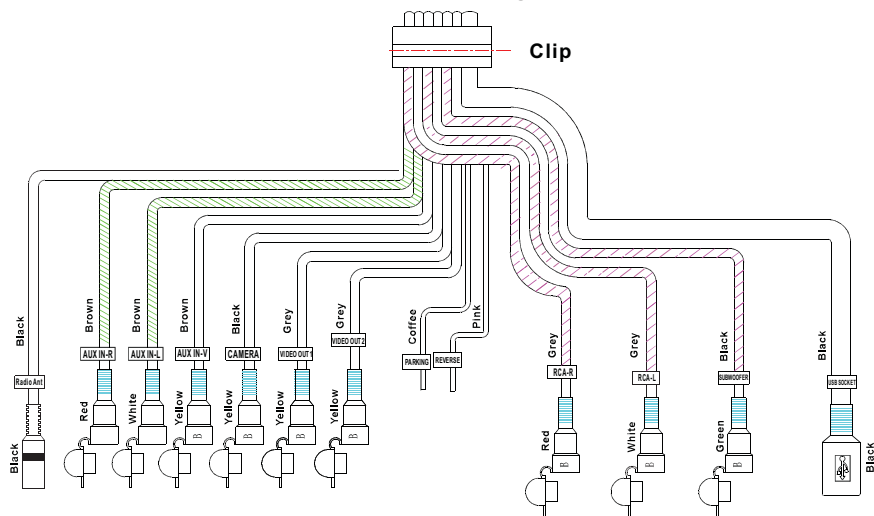

### The Description of the Fixed ISO Female Connector

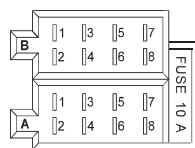

#### CONNECTOR A

1. Memory +12V
2. Auto Antenna Output
3. 12V (To Ignition Key)
4. GROUND

#### CONNECTOR B

1. Rear Right Speaker (+)
2. Rear Right Speaker (-)
3. Front Right Speaker (+)
4. Front Right Speaker (-)
5. Front Left Speaker (+)
6. Front Left Speaker (-)
7. Rear Left Speaker (+)
8. Rear Left Speaker (-)

For the DVD System Menu, there are 6 setup pages in all. They display as follows:

### 4.24.1 SYSTEM SETUP

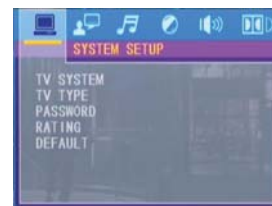

#### TV SYSTEM

This product supports output of various TV system. If your TV set has only NTSC or PAL system, the screen will blink and become colorless when a wrong TV system is selected. In this case, press the N/P button to switch the right TV system to match the TV color system.

#### TV TYPE

The setup item is for matching TV screen size.

4:3 PS: Choose the item when connecting a TV set with 4:3 screen. When playing the pictures with 16:9 size, the left and right parts of the video will be cut out, and display in full screen.

4:3 LB: Choose the item when connecting a TV set with 4:3 screen. When playing the pictures with 16:9 size, the top and bottom parts of the TV screen will be turned into a black square respectively.

16:9: Choose the item when connecting a TV set with 16:9 wide screen.

#### PASSWORD

This setup item is for locking or unlocking the rating level of the Parental Control. The defaulted state is locked. The defaulted password is 0000.

You can set a new password that you like: Select the PASSWORD item and then press the > button to enter it, then input the original password 0000, and then press the OK button to unlock it. Press the > button to enter it again, then input a new password that you like and then press the OK button to make it effective. Before the other persons see the Manual, you should get the password in mind and cut out the part of PASSWORD in the Manual.

#### RATING

The item is for setting a new rating level of the Parental Control.

1. Select the PASSWORD item and then press the > button to enter it, then input the password mentioned above, and then press the OK button to unlock the setting of the rating level of the Parental Control.
2. Select the RATING item and then press the > button to enter it, then use the direction buttons to select your desired rating level, then press the OK button to confirm.
3. Select the PASSWORD item again and then press the > button to enter it, then input the password, and then press the OK button to lock the new setting of the rating level of the Parental Control.

#### DEFAULT

This item is for making all setup items change back to original status.



- During IMAGE playback, press one of the >/</^/∨ buttons to change the angle of viewing picture that is displaying as follows:  
 >: 90 deg cw; <: 90deg ccw; ^:UP<-->DOWN; ∨: LEFT<-->RIGHT  
 During IMAGE playback, press the PROG button to change the mode of refresh picture.  
 During IMAGE playback, press the STOP button to stop playing and return to the root menu.

- \* During IMAGE playback, the following buttons are not available: SLOW-FWD, SUBTITLE, TITLE, ANGLE, AUDIO, RDM, INT and A-B.
- \* In IMAGE mode, the other operations are same as ones in MP3/WMA mode.

#### 4.22 Playback MP4 files

- The root menu is displayed on TV when beginning to switch on Mp4 mode, then it will automatically play the first file.  
 During playback, press the STOP button to stop playing and return to the root menu.
- When displaying the root menu, press the direction buttons to select your desired FOLDER, file or file sort icon, then press the OK or PLAY button to open the FOLDER, open the files of the file sort icon or play the selected file.  
 When displaying the root menu, you can also use the number buttons to select the serial number of the file and play the file.

- \* The ANGLE, PROG, RDM, INT and TITLE/PBC button are not valid.
- \* The other functions are same as ones in DVD mode; but the RPT function is same as one in MP3/WMA mode.

#### 4.23 ESP and ID3 Function

There is ESP function for all formats of discs.

In MP3/WMA mode, during playback, the information of the file name, folder name, song s title, artist and album will be scrolling on the LCD display. As long as the current playing MP3 music contains relevant ID3 tag information in version 1.0/2.0 format, the 3 items underlined above will be scrolling on the LCD display; otherwise, they will not.

#### 4.24 The DVD System Menu Setup Operation

- Press the SETUP button on the remote control to access the DVD System Menu on the monitor.
- There are 6 setup pages in all for the System Menu. Press the > or < button to select an desired setup page.
- Press the ^ or ∨ button to select an setup item in the selected setup page.
- Press the > button to enter the setup item. Then press the ∨ or ^ button to select a desired mode of the setup item, finally press the OK button to confirm it.

- \* Press the < button to return to the upper level.
- \* Press the SETUP button again or use the direction buttons to highlight the item of the EXIT SETUP and then press the OK button to exit the System Menu.

#### Description of Connecting the Parking Brake Line to the Parking Brake System Built in the Car

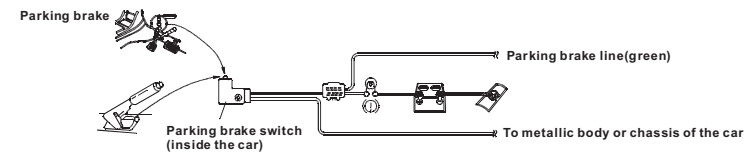

NOTE: after connecting the Parking Line, the video on the small monitor of the front panel will be display only after br aking the car.

## 1.8 UNIT INSTALLATION

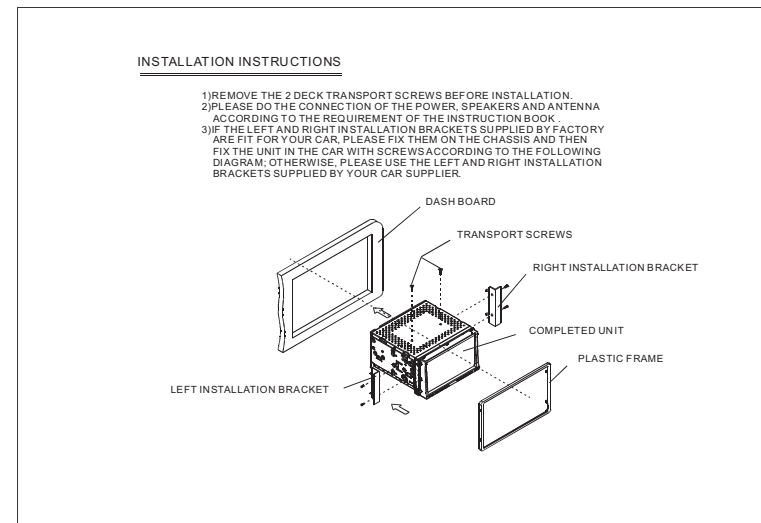

## 2. Common Operation

- To turn on/off the unit  
In power off mode, short press the POWER button to turn on the unit.  
In power on mode, long press the POWER button on the front panel or short press the POWER button on the remote control to turn off the unit.
- To select an optimal angle of the monitor of the Car Audio System  
To select an optimal angle of the monitor of the Car Audio System, press the ANG button on the front panel or TILT button on the remote control repeatedly.
- To select function mode  
Press the MODE button to select RADIO, DISC (After inserting a disc), USB (After inserting a USB storage), CARD (After inserting a card) or AUX mode.  
During playback, tapping the  icon after popping up Keyboard interface can pop up Mode Menu as right. then tap one icon in it to select your desired mode.
 

**Mode Menu**
- To adjust sound level  
press or hold the + or - button to directly adjust the volume level.
- To mute sound  
Press the MUTE button on the remote control to turn on/off MUTE mode.  
pressing the POWER button on the front panel shortly also can turn on/off MUTE mode.
- To display and adjust the clock time  
Press the CLK button to display clock time on the screen of the monitor.  
Long press the CLK button to change the color of the hour of the clock, then press the + or - button to adjust the hour; and then briefly press the CLK or SEL button to change the color of the minute of the clock, then press the + or - button to adjust the minute.
- To select a desired EQ mode  
Press the EQ button on the remote control to select one of the preset music equalizer curves: POP, ROCK, CLAS, FLAT. The sound effect will be changed.
- To turn on/off LOUD mode  
Press the LOUD button to turn on/off LOUD mode.  
When turning on LOUD mode, it will enhance bass level immediately when bass is not enough.
- To reset the player  
When the monitor display wrongly or some buttons are not available or sound is distorted, press the RESET button to rehabilitate the distorted program to zero.

## 4.20 Program Playback

It allows you to enter the order in which you want some chapters/tracks in DVD/VCD/MP3/WMA/CD to play.

- During playback, press the PROG button to enter a program interface as follows:

for DVD



for VCD/MP3/WMA/CD

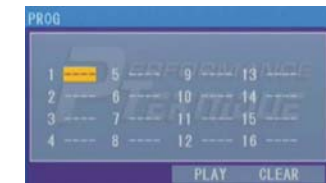

- Use the direction buttons to move cursor onto the desired place for inputting the sequence number.
- Use the number button to input desired sequence number of title/chapter/track with desired sequence.
- Use the direction button to move cursor onto Play item, then press the OK button to play the programmed titles/chapters/tracks in programmed order; only pressing the PLAY button also can play the programmed titles/chapters/tracks in programmed order.
- To exit program playback, firstly press the STOP button, then press the PLAY button to enter sequence playback; or press the PROG button twice again.
- To remove the all programmed sequence numbers, move the cursor onto Clear item, then press the OK button.
- To change the programmed sequence, move the cursor onto the item you want to change, input the desired sequence number.
- During VCD playback, if it is in PBC ON mode, at the same time of entering the state of program playback, it turns off PBC mode.

## 4.21 Playback IMAGE files

- The root menu is displayed on the monitor when beginning to switch on IMAGE mode. .  
In the root menu, the left file sort icon is for MP3/WMA file; the middle file sort icon is for IMAGE file; the right file sort icon is for VIDEO file. If one of these 3 file sort does not exist, you can not move cursor onto the file sort icon.
- When displaying the root menu, press the direction buttons to select your desired FOLDER, file or file sort icon, then press the OK or PLAY button to open the FOLDER, or play the selected file, or play only this sort of file.  
When displaying the root menu, you can also use the number buttons to select the serial number of the file and play the file.  
When you select the IMAGE file sort icon, press the ^ or > button to select the first IMAGE file, then press the v button to select the desired IMAGE file, finally press the OK or PLAY/PAUSE button to display the image in full screen from the selected IMAGE file.

ZOOMx2,ZOOMx3,ZOOMx4,ZOOMx1/2,ZOOMx1/3,ZOOMx1/4,ZOOM OFF.  
Press one of the ^/v/>/< buttons to select the area you want to enlarge.

#### 4.16 Change the Caption Language

In the state of DVD playing, press the SUBTITLE button repeatedly to select the language of the caption or turn off the caption.(depend on the media used.)

In the state of VCD/MP3/WMA/CD playing, the button is not available.

#### 4.17 Change the Audio Language

1. In the state of DVD playing, press the AUDIO button repeatedly on the IR remote control to select the desired language type. (depend on the media used)
2. In the state of VCD playing, press the AUDIO button repeatedly to select the sound mode of the MONO L, MONO R, MIX MONO and Stereo, no language function.
3. In the state of CD/WMA/MP3 playing, the AUDIO button is invalid.

#### 4.18 Change the Video Signal System

During playback of DVD/VCD , press the BAND(P/N) button repeatedly to change the VIDEO SIGNAL SYSTEM mode .

#### 4.19 Look over the Playback Status

1. In the state of DVD playing, press the OSD button repeatedly on the remote control to turn on/off the playback status. When it is on, it will display the information such as: the serial number of the playing title, the serial number of the playing chapter, the elapsed time of the playing chapter, the remained time of the playing chapter, the elapsed time of the playing title, the remained time of the playing title, etc.
2. In the state of VCD/CD playing, press the OSD button repeatedly on the remote control to turn on/off the playback status. When it is on, it will display the information such as: the serial number of the playing track, the elapsed time of the playing track, the remained time of the playing track, the elapsed time of the disc, the remained time of the disc.
3. In the state of MP3/WMA playing, press the OSD button repeatedly on the remote control to turn on/off the playback status. When it is on, it will display the information such as: the serial number of the playing track, the elapsed time of the playing track, the remained time of the playing track.

#### 11. To do general setup

To do general setup, first pop up Mode Menu as in item 2, then tap the  icon in the Mode Menu to pop up GENERAL SETUP interface as right.

In the interface, select one of CLOCK SET, RDS MODE , OSD LANG, RADIO FREQ and SENSE SET on the left side by tapping them, then set them by tapping some icons on the right side accordingly.

- \* SENSE SET is used to set the sensitivity of stopping auto searching for an available radio station. When you tap it, it will ask you to input a password. The password is 191713, after inputting it, you can set the item.



GENERAL SETUP

#### 12. To do calibration



To pop up Calibration interface during media playback, first press the STOP button twice, then press the ZOOM button, finally press the ^ and v buttons in turn.

In the interface, you can have calibration by accurately tapping the cross cursor.

#### 3. Radio Operation

##### 1. Enter RADIO mode

When you use MODE button or Mode Menu to enter RADIO mode, it will display RADIO interface as right.

In RADIO interface, tapping the  icon can enter Mode Menu; tapping the  icon can turn on or off TFT display; tapping the  icon can pop up AUDIO & VIDEO SETUP interface as right; the other icons are same as the corresponding buttons in the unit panel or in the Remote Control.



RADIO interface

In the AUDIO & VIDEO SETUP interface, you can adjust VOLUME, TREBLE, BASS, BALANCE, FADER, BRIGHTNESS, CONTRAST, COLOR, HUE; you can also turn on or off DBAS, MBP, LOUD; you can still select your desired transparency mode(by STD) and EQ mode(by EQ); tapping the  icon can return back to the previous status.



AUDIO & VIDEO SETUP interface

##### 2. BAND BUTTON

In RADIO mode, press the BAND button on the remote control to select your desired radio band of FM1, FM2, FM3, AM1 and AM2, and the word means which band is selected will be displayed on the small monitor of the front panel.

##### 3. TUNE/SEEK UP/DOWN BUTTONS

In RADIO mode:

- 1) Long press the >>|/|<< button to automatically search up/down for a available station from the current frequency.
  - 2) Briefly press the >>|/|<< button to manually search up / down with step by step for your desired station from the current frequency.
- ##### 4. APS BUTTON
- In RADIO mode:
- 1) When long pressing the APS button, the radio searches from the lowest frequency and checks the signal strength level until 1 cycle search is finished. And then the 6 strongest stations are preset to the corresponding preset number memory bank. The AS operation is implemented in the each bank of the selected band. When the AS operation is finished, it will scan each preset station for 5 seconds in FM or AM band from M1 as briefly pressing APS button. After

finishing a circle of scanning , it will resume broadcasting on the M1.(It can store 3x6 stations for FM and 2x6 stations for AM in all)

- 2) When briefly pressing the APS button, the radio will scan each preset station for 5 seconds in FM or AM band from M1. After finishing a circle of scanning, it will resume broadcasting on the M1.

NOTE: In FM band, FM1,FM2,FM3 is checked one at a time.  
In AM band, AM1, AM2 is checked one at a time.

#### 5. PRESET STATION [ 1-6 ] BUTTONS

In RADIO mode:

- 1) To memorize the current frequency on the current band, long press any one of the six preset buttons (1-6) .
- 2) To recall the preset memory on the current band, press one of the preset buttons [1-6] .

#### 6. STEREO/MONO BUTTON

Press the ST button on the remote controller to select the STEREO or MONO sound mode for FM band.

#### 7. LOC BUTTON

- 1) In RADIO mode, when the signal of the distance radio station are very weak and the receiving effect is bad during tuning, check whether there is the word LOC on LCD. If there is the word LOC on LCD, press this button to turn off the LOC function, then tune again for the distance radio station;
- 2) In RADIO mode, when the signal of the local radio station are too strong to lead that the interference to the receiving effect during tuning, press this button to turn on the LOC function to display the word LOC on LCD, then tune again for the local radio station.

### 4. Disc, USB and CARD Operation

#### 4.1 Load/unload disc, USB or CARD

To play files in a disc or card, press the EJECT button to slide down the monitor . Then insert the disc or card into the disc slot or SD/MMC Card slot.

To unload the disc or card, press the STOP button twice to stop playback, then press the EJECT button to slide down the monitor and eject disc in the disc slot and then remove the disc; or push the card firstly and pull it out of the card slot.

#### 4.11 Playback in Scan Mode

1. In the state of VCD(PBC OFF)/CD playing, press the INT button to play the previous 15 seconds part of each track on the disc. Press the INT button again to resume normal playback.
2. In the state of DVD/MP3/WMA playing, the INT button is not available.

#### 4.12 Playback from a specified chapter/track or a specified time

1. In the state of DVD playing, press the SEARCH button to display a interface and highlight the title item, then use the number buttons to input the serial number of the title; use the direction buttons to highlight the chapter item, then use the number buttons to input the serial number of the chapter; you can still use the direction buttons to highlight the time item, then use the number buttons to input the desired time to start playback; finally press the OK or PLAY button to play the selected chapter or play from the selected time.
2. In the state of VCD/MP3/WMA/CD playing, press the SEARCH button to display a interface and highlight the track item, then use the number buttons to input the serial number of the track; you can still use the direction buttons to highlight the time item, then use the number buttons to input the desired time to start playback; finally press the OK or PLAY button to play the selected track or play from the selected time.

#### 4.13 Playback in Random

In the state of DVD/VCD(PBC OFF)/MP3/WMA/CD playing, press the RDM button to switch between RANDOM (ON)/RANDOM OFF. When in RANDOM (ON) mode, it will play in random.

#### 4.14 Playback in Different View-Angle

1. In the state of VCD/MP3/WMA/CD playing, the VIEW-ANGLE button on the IR remote control is not available.
2. In the state of DVD playing, press the VIEW-ANGLE button repeatedly on the IR remote control to view in different angle.(This function is only for the DVD media with ANGLE function)

#### 4.15 Playback in Zoom Mode

In video/image mode, during playback, press the ZOOM button continuously to enlarge a certain area of the images on the screen with these multiples:

During slow forward, press the PLAY button to resume normal playback. The function is only for video.

#### 4.9 Display still frame step by step

If the unit is currently playing video, press the TEL button consecutively to display still frame step by step. Press the PLAY button to resume normal playback.

#### 4.10 Playback Repeatedly

##### 4.10.1 ONE/ALL Repeat

- In the mode of DVD playback:  
Press the RPT button to select REP CHAPTER, REP TITLE, REP ALL or REP OFF.
- In the mode of VCD(PBC OFF)/CD playback:  
press the RPT button to select REP ONE, REP ALL or OFF.

When it is in the state of PBC ON, during VCD disc playing, the RPT button are not available.

- In the mode of MP3/WMA playback:  
Press the RPT button to select REP ONE, REP DIR, REP ALL or OFF.

##### 4.10.2 A-B Repeat

Press the **A-B** button if you want to repeat a specific segment on a disc that you define:

- Press the **A-B** button at a point (A) where you want it to be the start point of the repeat segment. Press the **A-B** button again at a point (B) where you want it to be the terminal point of the repeat segment. Then it will play the segment repeatedly.
- To cancel the A-B repeat mode and resume normal playback, press the **A-B** button for the third time.



Note:

During VCD/MP3/WMA/CD playback, points A and B must be within the same track.











During DVD playback, points A and B can be selected from different chapters.

To play files in an USB, insert the USB into the USB jack connecting to the Rear cabinet.

To unload the USB, press the STOP button twice and then remove the USB .

**Remark:** If the disc or USB includes folder(for MP3/WMA/MP4/JPEG files), after loading, it will display a root as right. On the bottom side of the root, the  icon is for audio files; the  icon is for image files; the  icon is for Video files. If files of these 3 file sort does not exist, you can not move cursor onto the file sort icon.

**Remark:** During playback, tapping the  icon in the root (for MP3/WMA/MP4/JPEG) or any place on the screen (for CD/VCD/DVD/MP4/JPEG) can pop up the keyboard interface as right.

-  : Tapping it can pop up Mode Menu.
  -  : Same as the corresponding buttons on the Remote Control.(for MP3/WMA/MP4/JPEG)
  -  : Same as the corresponding button on the Remote Control.(for MP3/WMA/MP4/JPEG)
  -  : Same as the corresponding button on the Remote Control or on the front panel.
  -  : Same as the TITLE button on the Remote Control (available only for DVD).
  -  : Tapping it can stop playback and pop up the root.(exist only for MP4/JPEG)
  -  : Tapping one of them can select next or previous chapter/track.
  -  : Tapping one of them can switch on between the speed levels of fast backward or forward.
  -  : Tapping it can pop up the AUDIO interface of the SET Menu as right. In the interface, you can adjust the levels of VOLUME, BASS, TREBLE, BALANCE and FADER; can turn on or off LOUD, DBAS and MBP; can select your desired EQ mode. Tapping  icon can pop up the TFT VIDEO interface of the SET Menu as right. In the interface, you can adjust the levels of BRIGHTNESS, CONTRAST, COLOR and HUE; you can also adjust Transparency by tapping USER, STDY , BRIG, SOFT and SHAR.
- \* SET icon = SEL button.

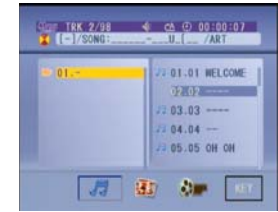

Root interface for MP3/WMA/MP4/JPEG



Keyboard interface-1



Keyboard interface-2

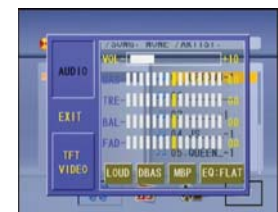

SET Menu-1

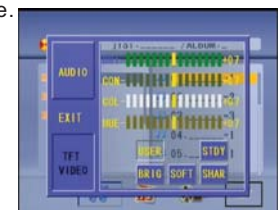

SET Menu-2

#### 4.2 Pause Playback

In the state of DVD/VCD/CD/MP3/WMA playing, press the PAUSE button on IR remote control to pause the playback, press the PLAY button to resume normal playback.

#### 4.3 Stop Playback

In the state of DVD/VCD/MP3/WMA/CD playing, press the STOP button once to pause the playback, then press the PLAY button to resume the normal playback; press the STOP button twice to full stop the playback, then press the PLAY button to start playback from the beginning of the first chapter/track.

#### 4.4 Select Chapter/Track with the >>|/|<< Button

Press the >>|/|<< button during playback to select the next or last chapter/track to playback.

Note: Press the >>|/|<< button multiple times to advance multiple chapters/tracks forward or backward.

#### 4.5 Select Chapter/Track with the Number Buttons

In the state of DVD/VCD(PBC OFF)/MP3/WMA/CD playing, press one of the 1~9 and the 0/10 number buttons to directly select and play the 1st to 10th track/chapter (the 0/10 button is used as the 10 button).

If you want to play the track/chapter that's serial number is bigger than 10, use the 10+, 1~9 and 0/10 button. For example 1, to play the 13th track/chapter, firstly press the 10+ button once, then press the 3 button. For example 2, to play the 34th track/chapter, firstly press the 10+ button for 3 times, then press the 4 button.(the 0/10 button is used as the 0 button)

Note: long pressing the +10 or -10 button can play the next 10 or last 10 chapter/track(only for MP3/WMA/CD).

#### 4.6 Select Chapter/Track with the Root/PBC Menu (If the disc includes the root/PBC menu)

In the state of DVD playing

1. Press the TITLE button on the remote control to display the title list.

2. Press the direction buttons to select your desired title, and then press the OK or PLAY button to open the root menu of the selected title.
3. Press the direction buttons to select your desired chapter, finally press the OK or PLAY button to play the selected chapter. During playback, pressing the MENU button can directly display the root menu of the title that is playing.

In VCD mode

1. When starting to turn on the PBC function, it will play from the beginning of the disc till it display the PBC menu on TV screen if the disc include the PBC menu.
2. Press the number buttons to select your desired track to play.

In MP3/WMA mode

1. The root menu is displayed on the monitor screen all the time(and the TITLE or MENU button is not available).
2. Press the direction buttons to select your desired FOLDER, then press the OK or PLAY button to open the FOLDER, and then press the direction buttons to select your desired file, finally press the OK button to play the selected file.

In CD mode, the TITLE, PBC, MENU buttons are disabled.

#### 4.7 Playback with Speed

During normal playback, long press the >>|/|<< button on the remote control continuously to fast forwards or backwards at the following speeds: x2, x4, x8, x20, normal.

During speed playback, press the PLAY button to resume normal playback.

#### 4.8 Playback with Slow Speed

During playback, press the SLOW\_FWD button to execute the Slow Forward function.

With each consecutive pressing of the SLOW\_FWD button, the playback speed decreases. The speed levels in Slow Forward as follows: x1/2, x1/3, x1/4, x1/5, x1/6, x1/7, normal.

## Free Manuals Download Website

<http://myh66.com>

<http://usermanuals.us>

<http://www.somanuals.com>

<http://www.4manuals.cc>

<http://www.manual-lib.com>

<http://www.404manual.com>

<http://www.luxmanual.com>

<http://aubethermostatmanual.com>

Golf course search by state

<http://golfingnear.com>

Email search by domain

<http://emailbydomain.com>

Auto manuals search

<http://auto.somanuals.com>

TV manuals search

<http://tv.somanuals.com>