

PYLE®

PLDVD178USB

OWNER'S MANUAL

Mobile Video System

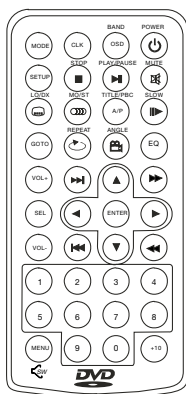
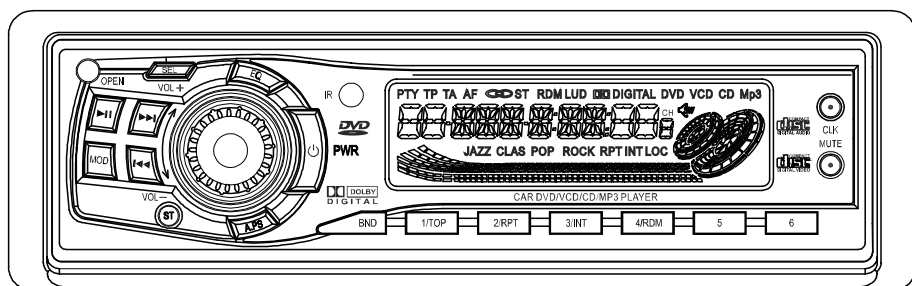

**DVD/VCD/CD/MP3 PLAYER WITH
AM/FM-STEREO DIGITAL PLL TUNING RADIO
WITH ANTI-THEFT FLIP DOWN DETACHABLE PANEL**

www.pyleaudio.com

Download from www.Somanuals.com. All Manuals Search And Download.

CONTENTS

Safety Information	2
Disc Notes	3
Installation	4
Electric Connection	7
Remote Control	8
Basic Operation	10
MP3 Disc Play	13
USB operation	14
On-Screen Display Function	14
Multi-audio Language Function	15
Title Menu Function	15
Multi-subtitle Language Function	15
Multi-angle Function	15
Setup	16
Initial Setup	16
General Setup	16
Speaker Setup	18
Audio Setup	18
Preferences Setup	19
Defaults Table	21
Specifications	22
Trouble Shooting	23

SAFETY INFORMATION

CAUTION:

THIS DVD PLAYER IS A CLASS I LASER PRODUCT. HOWEVER THIS DVD PLAYER USES A VISIBLE/INVISIBLE LASER BEAM WHICH COULD CAUSE HAZARDOUS RADIATION EXPOSURE IF DIRECTED. BE SURE TO OPERATE THE DVD PLAYER CORRECTLY AS INSTRUCTED.

USE OF CONTROLS OR ADJUSTMENTS OR PERFORMANCE OF PROCEDURES OTHER THAN THOSE SPECIFIED HEREIN MAY RESULT IN HAZARDOUS RADIATION EXPOSURE. DO NOT OPEN COVERS AND - DO NOT REPAIR YOURSELF. REFER SERVICING TO QUALIFIED PERSONNEL.

WARNING:

TO REDUCE THE RISK OF FIRE OR ELECTRIC SHOCK, DO NOT EXPOSE THIS EQUIPMENT TO RAIN OR MOISTURE.

TO REDUCE THE RISK OF FIRE OR ELECTRIC SHOCK, AND ANNOYING INTERFERENCE, USE ONLY THE RECOMMENDED ACCESSORIES.

THIS DEVICE IS INTENDED FOR CONTINUOUS OPERATION.

This product incorporates copyright protection technology that is protected by method claims of certain U.S. patents and other intellectual property rights owned by Macrovision Corporation and other rights owners. Use of this copyright protection technology must be authorized by Macrovision Corporation, and is intended for home and other limited viewing uses only unless otherwise authorized by Macrovision Corporation. Reverse engineering or disassembly is prohibited.

REGION MANAGEMENT INFORMATION:

This DVD Player is designed and manufactured to respond to the Region Management Information that is recorded on a DVD disc. If the Region number described on the DVD disc does not correspond to the Region number of this DVD Player, this DVD Player cannot play this disc.

DISC NOTES

Disc formats supported by this player



- DVD**
12 cm disc
(Single-sided disc only)
- Video CD**
12 cm disc
- CD**
12 cm disc
- MP3**
12 cm disc

Discs which cannot be played with this player

- DVD-ROM
- DVD-R/DVD-RAM
- CDV
- CD-G

Handling and Cleaning

- Dirt, dust, scratches and warping disc will cause misoperation.
- Do not place stickers or make scratches on discs.
- Do not warp discs.
- A disc should always be kept in its case when not in use to prevent from damaging.
- Do not place discs in the following places:
 1. Direct sunlight
 2. Dirty, dusty and damp areas
 3. Near car heaters
 4. On the seats or dashboard

Disc Cleaning

Use a dry soft cloth to wipe the surface. If the disc is quite dirty, use a soft cloth slightly moistured with isopropyl (rubbing) alcohol. Never use solvents such as benzene, thinner or conventional record cleaners as they may mar the surface of the disc.

Note:

A disc may become somewhat scratched (although not enough to make it unusable) depending on your handle it and conditions in the usage environment. Note these scratches are not an indication of any problem with the player.

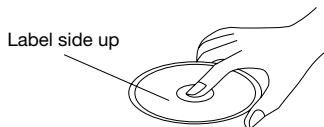

Label side up



Do not touch the underside of the disc



Do not bend

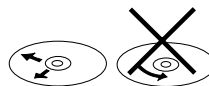

Wipe the disc from center toward the outside edge

Preparing New Discs with Rough Spots

A new disc may have rough edges on its inside and outside edges. If a disc with rough edges is used, the proper setting will not be performed and the player will not play the disc. Therefore, remove the rough edges in advance by using a ball point pen or pencil as shown on the right. To remove the rough edges, press the side of the pen or pencil against the inside and outside edges of the disc.

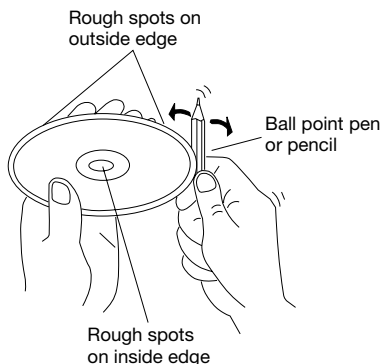

Rough spots on outside edge

Ball point pen or pencil

Rough spots on inside edge

INSTALLATION

Notes:

- Choose the mounting location where the unit will not interfere with the normal driving function of the driver.
- Before finally installing the unit, connect the wiring temporarily and make sure it is all connected up properly and the unit and the system work properly.
- Use only the parts included with the unit to ensure proper installation. The use of unauthorized parts can cause malfunctions.
- Consult with your nearest dealer if installation requires the drilling of holes or other modifications of the vehicle.
- Install the unit where it does not get in the driver's way and cannot injure the passenger if there is a sudden stop, like an emergency stop.
- If installation angle exceeds 30° from horizontal, the unit might not give its optimum performance.

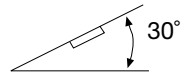

- Avoid installing the unit where it would be subject to high temperature, such as from direct sunlight, or from hot air, from the heater, or where it would be subject to dust, dirt or excessive vibration.

DIN FRONT/REAR-MOUNT

This unit can be properly installed either from “Front” (conventional DIN Front-mount) or “Rear” (DIN Rear-mount installation, utilizing threaded screw holes at the sides of the unit chassis). For details, refer to the following illustrated installation methods.

INSTALLATION

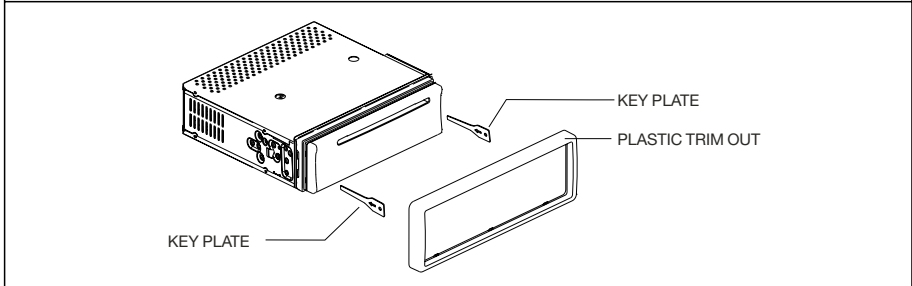
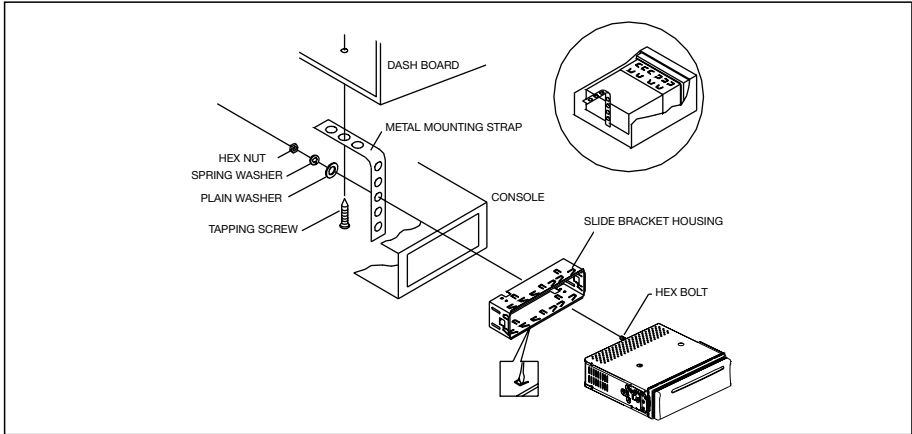

1. WHILE INSTALLING THE FRONT PANEL, PLEASE MOUNT THE LEFT SIDE FIRST, AND MAKE THE DIRECTION HOLE ON THE FRONT PANEL AIM AT THE LEFT GUIDE ON THE UNIT.
2. THEN PUSH THE RIGHT SIDE TO MOUNT THE RIGHT GUIDE.

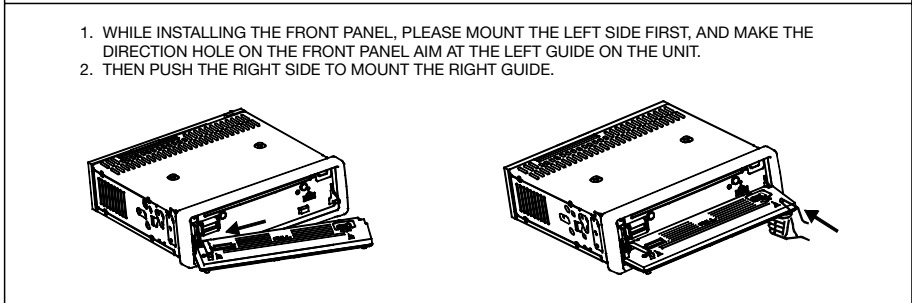

3. PUSH IT TO INSTALL THE FRONT PANEL COMPLETELY.

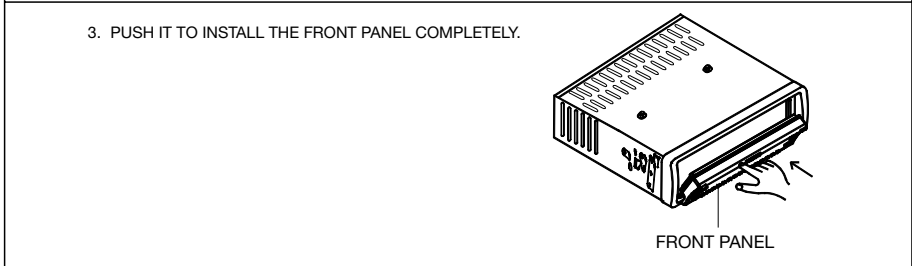

INSTALLATION

CAUTION: DO NOT INSTALL THE DETACHABLE PANEL BEFORE CONNECTING THE WIRE.

1. The unit is designed for negative terminal of the battery which is connected to the vehicle metal. Please confirm it before installation.
2. If the car interior is extremely hot, as after being parked in the sun, do not use the player until the car has been driven for a while to cool off the interior.
3. Press the OPEN button to flip down the front panel (see fig.1), Slide the guide knob to remove the right side first, then take away the front panel (see fig.2) and put it in the protective case (see fig.3) for safe keeping.
4. Install the front panel back into its bracket and then push it back to the position for playing (see fig.4).

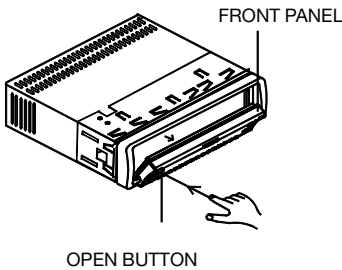

(FIG.1)

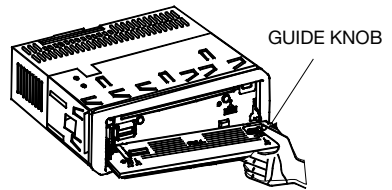

(FIG.2)

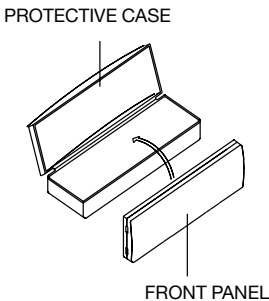

(FIG.3)

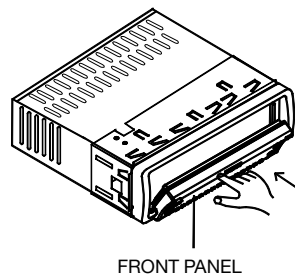

(FIG.4)

ELECTRIC CONNECTION

WIRING CONNECTION

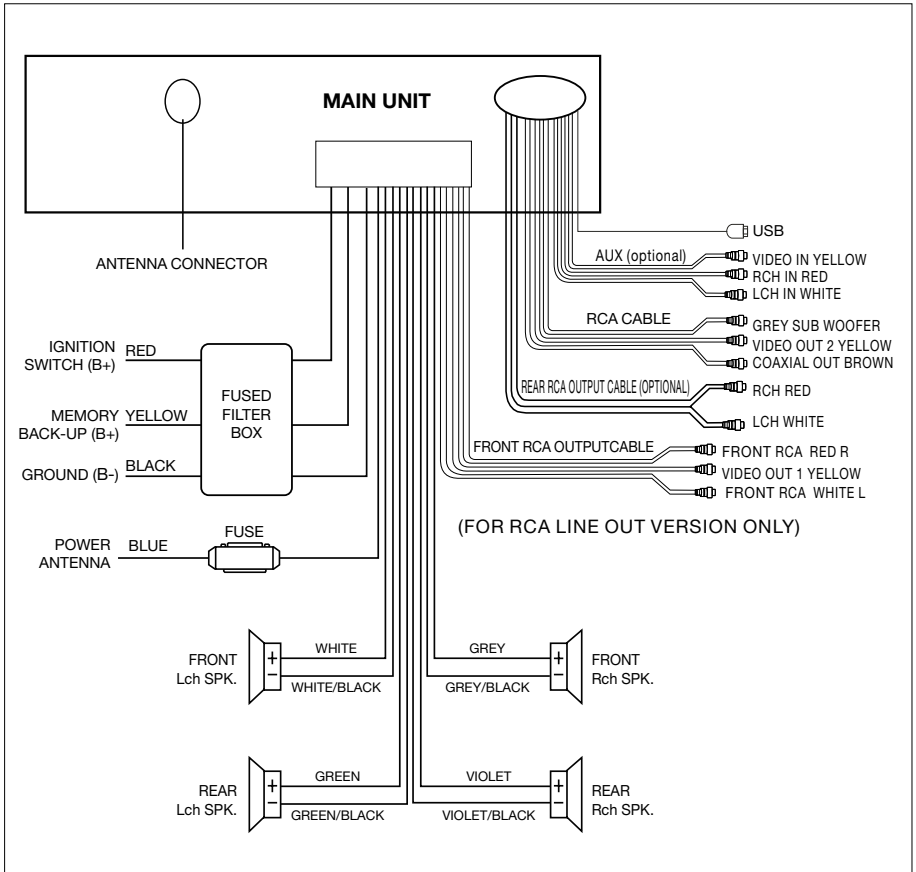

NOTE:

The accessory USB clip of this unit as below. On side clip the USB cable, the other side clip the proper place to fixed the USB cable.

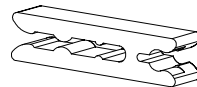

REMOTE CONTROL

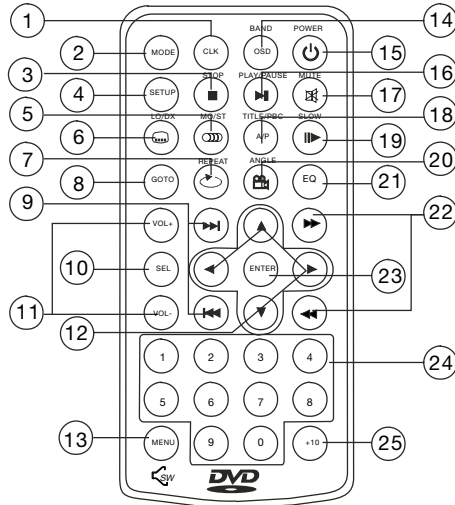

- | | |
|--|---|
| <ol style="list-style-type: none"> 1. CLK 2. MODE 3. STOP 4. SETUP 5. MO/ST (AUDIO) 6. LO/DX (SUBTITLE) 7. REPEAT 8. GOTO 9. ◀▶ 10. SEL 11. VOL+/VOL- 12. ▲▼▶◀ 13. MENU/SUBWOOFER 14. BAND(OSD) 15. POWER 16. PLAY/PAUSE 17. MUTE 18. TITLE/PBC (A/P) 19. SLOW 20. ANGLE 21. EQ 22. ◀◀/▶▶ 23. ENTER 24. 0 - 9 25. +10 | <p>Press it to change the display to clock display.</p> <p>Press it to change between radio or disc mode.</p> <p>Press it to stop playback.</p> <p>Display the SETUP menu.</p> <p>Press it to select STEREO or MONO (In disc stations, press it to changing of the AUDIO soundtrack on multi-audio soundtrack DVD disc. Changing of the sound mode of the VCD/CD disc)</p> <p>Changing of the SUBTITLE language on multi-subtitle language DVD disc. In radio mode, press this button for distance reception when you are located at weak signal location, depress it for stronger signal.</p> <p>Switch the Repeat mode of DVD/VCD/CD disc.</p> <p>Disc search button, cooperatively used with numeric buttons</p> <p>Press ▶▶ to skip to the next track & press ◀◀ to skip back one track.</p> <p>Press it to change audio mode through Volume, Bass, Treble, Balance and Fader modes.</p> <p>Press it to adjust volume level.</p> <p>Cursor buttons in MENU mode.</p> <p>Press it to display the root menu of the DVD disc./ Press and hold for more than 2 seconds can have subwoofer.</p> <p>Display statistical disc information during playback (To change the band in radio stations)</p> <p>Press it to turn on the unit, press it again to turn off.</p> <p>Press once to pause a play, press again to resume playback.</p> <p>Press it to mute down sound.</p> <p>Display the TITLE menu that is stored in DVD disc changing between PBC ON and PBC OFF on the VCD disc. (Auto store and preset scan function in radio stations.)</p> <p>Changing for slow forward/reverse playback motion.</p> <p>Changing of the view angle on multi-angle DVD disc</p> <p>Press it to turn to equalization function.</p> <p>Press ▶▶ to start forward rapidly & ◀◀ to reverse rapidly.</p> <p>Confirm the Track/Chapter selected with the number key or selected with the cursor buttons on TV screen.</p> <p>Numeric buttons</p> <p>Press it to select 10th digits</p> |
|--|---|

REMOTE CONTROL

Preparing the Remote Control

Inserting the Batteries

1. Open the battery compartment cover.
2. Insert the new batteries. Make sure that the positive and negative terminals of the batteries are oriented indicated.
3. Close the cover

Using the Remote Control

Face the remote control towards the player front face IR mark (remote control signal receiver).

Operation angle: About ± 30 degree in each the direction of the front of the IR mark.

To prevent damage to the unit, be sure to follow the connection diagram (page 7).

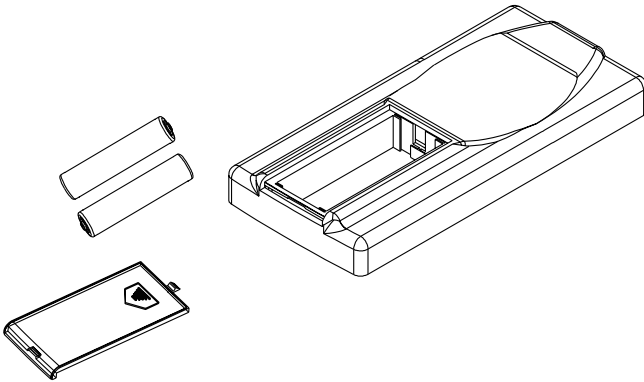

BASIC OPERATION

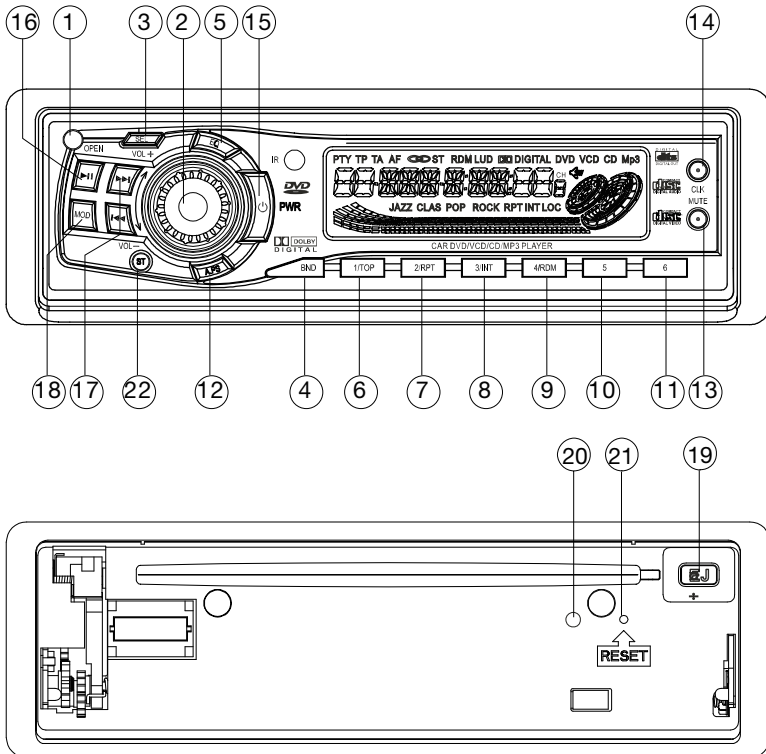

1. OPEN BUTTON

Press it to flip down the front panel. Then you can insert the CD disc into the CD compartment. And you can find the OPEN button. Press it to eject the disc.

2-3. VOL +/- VOL - & SEL BUTTON

Press it to change audio mode through volume, bass, treble, balance, and fader modes. Rotate VOL +/- VOL- knob to adjust the selected mode. When mode has not been adjusted for several seconds, display returns to normal radio or CD display.



- A. Volume:** Adjust volume level by rotating VOL +/- VOL- knob.
Note: The unit is initially set to volume mode.
- B. Bass:** Press SEL button one time. Adjust bass level by rotating VOL +/- VOL- knob.
- C. Treble:** Press SEL button two times. Adjust treble level by rotating VOL +/- VOL- knob.
- D. Balance:** Press SEL button three times. Adjust sound balance between left and right speakers by rotating VOL +/- VOL- knob.
- E. Fader:** Press SEL button four times. Adjust sound balance between front and rear speakers by rotating VOL +/- VOL- knob.

BASIC OPERATION

4. BAND BUTTON

In RADIO mode, press the **BAND** button on the front panel or on the remote controller to select your desired radio band and word which band is selected will be displayed on LCD. Press it to change the bands as below:



For 3 Bands (Europe)



For 2 Bands (Europe)

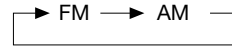

For 2 Bands (USA)

5. EQ BUTTON

Press it to turn to equalization function and to select desired audio mode. There are four kinds of mode as below:



6-7-8-9-10-11. PRESET STATION

- A. To memorize the current frequency, press any one of the six preset buttons [1-6] on the front panel or on the remote controller hold for more than 2 seconds.
- B. To recall the preset memory, press one of the preset buttons [1-6].
- C. Press **1/TOP** button to select the first track/ chapter to play.
 - a. In the state of VCD/CD/MP3 disc playing, press the button on the front panel to select the first track / chapter to play. (depending on the disc used for VCD)
 - b. In the state of DVD disc playing, the 1/TOP button is not available.
- D. Press **2/RPT** button to select repeat mode as follow:

DVD:



VCD/CD:

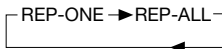

- a. Continuously repeat at the current chapter/track, when selected REP-ONE mode.
- b. Select REP-ALL mode to continuously repeat all chapter/track on the current disc.
- c. REPEAT feature does not support VCD2.0 (with PBC ON).
- E. Press **3/INT** button to scan disc.
 - a. In the state of VCD/CD disc playing, press the 3/INT button on the front panel to play the previous 10 seconds part of each track/chapter on disc. (depend on the disc used for VCD)
 - b. In the state of DVD/MP3 disc playing, the 3/INT button is not available.
- F. Press **4/RDM** to play disc in random.
 - a. In the state of VCD/CD/MP3 disc playing, press the 4/RDM button on the front panel to play in random or select DISC REP. (depend on the disc used for VCD)
 - b. In the state of DVD disc playing, the 4/RDM button is not available.

BASIC OPERATION

12. AS/PS BUTTON

When shortly pressing the APS button on the front panel or the A/P button on the remote controller, the radio searches for each preset station. When the field strength level is more than the threshold level of stop level, the radio is holding at that preset number for few seconds with releasing mute, and then searches again. In FM band, FM 1, FM 2 and FM 3 is checked one at a time. When long pressing the APS or A/P button (more than 1 second), the radio searches from the current frequency and checks the signal strength level until 1 cycle search is finished. And then 6 strongest stations are preset to the corresponding preset number. The AS operation is implemented in the each band of selected band. When the AS operation is finished, the radio executes the preset scan.

13. MU BUTTON

Press it to mute down sound. Press it again to release this mode and recover previous volume level.

14. CLK BUTTON

Press it to change the display to clock display. Press it again to return to previous display. In clock display, press and hold for about 2 seconds until the hour display flashes. Rotate VOL +/- button to adjust hours, press CLK button to flash minute then rotate VOL +/- button to adjust minutes.

15. PWR BUTTON

Press it to turn on the unit. Press it again to turn off.

16. PAUSE BUTTON

Pressing PAUSE during playback will stop play temporary. Return to normal playback, press PAUSE once again.

17. FAST FORWARD / FAST REVERSE BUTTON

A. When long pressing the FAST FORWARD / FAST REVERSE button (more than 2 seconds) during play, the speed of rapid forward/reverse changes according to the disc as follow.

DVD/VCD/CD/MP3:

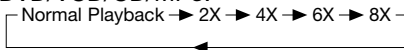

B. Shortly press the FAST FORWARD / FAST REVERSE button during playback to skip to next track or back one track.

Note: For some VCD2.0 discs (PBC-playback control), FAST FORWARD and FAST REVERSE buttons may be unavailable.

C. Press UP or DN button on the remote controller or FAST FORWARD / FAST REVERSE on the front panel to manually tune up or down for your desired station. Press them hold for more than 2 seconds to automatically tune up or down for the stronger station.

BASIC OPERATION

18. MOD BUTTON

Press it repeatedly select DISC, AUX IN, RADIO mode. In USB playing, you can press the stop button to stop playing, then press GOTO button to display the DVD dire and USB dev on the screen, press UP/DN button to select the DVD dire to select the DVD mode, then playing the DVD disc.

19. EJECT BUTTON

In CDP playing, press the eject button to eject the disc from the disc slot. If in USB playing, you must change the mode to the DVD mode to eject the disc, otherwise, you cannot eject the disc from the disc slot.

20. FLASHING LED

If the front panel is not on the main unit, LED will be flashing.

21. RESET BUTTON

RESET button is placed on the housing and must be activated with either a ballpoint pen or thin metal object. The RESET button is to be activated for the following reasons:

- Initial installation of the unit when all wiring is completed.
- All the function buttons do not operate.
- Error symbol on the display.

Note: If press RESET button, the unit can't work yet, please use a cotton swab soaked in isopropyl alcohol to clean the socket on the back of the front panel.

22. ST BUTTON

Press ST button to select stereo or mono reception for radio stations.

MP3 DISC PLAY

1. MP3 disc is playing as the format of FOLDER by FOLDER.

For example:

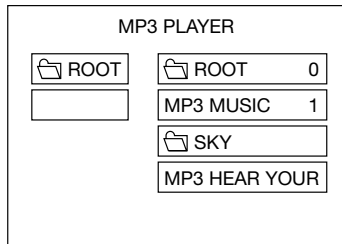

Use ▲/▼/▶/◀ to select the item or folder, then press **ENTER** button.

Pressing **REPEAT** button repeatedly can select three kinds of repeat play mode.

2. REP-ONE:

Play the same song over and over again.

3. FOLDER REPEAT:

Play all songs in the current directory in sequence, over and over again.

4. DISC REPEAT:

Play all songs in the disc over and over again.

In the playback, use ◀◀ or ▶▶ to skip an item ahead or back.

When long pressing the ▶▶/◀◀ to fast rapid forward/reverse.

Note: The FOLDER cannot be selected during playing. It can be selected after ■ (Stop) button pressed.

BASIC OPERATION

USB operation

- A. Connect the USB appliance to the USB port of the unit properly, when the USB appliance connect to the unit, the system starts playing track of the USB appliance automatically.
- B. Press the **▶▶/◀◀** button to skip to the next track or skip to the back one track. Press the **▶▶/◀◀** button to fast forward or fast reverse.
- C. In USB playing, you can press the cursor button to select the item. Then press ENTER button to play. Also press numeric button to play the corresponding track directly. Press the repeat button to select repeat play mode.
- D. In USB mode, you cannot take out of the disc from the disc compartment. You press the stop button then press the GOTO button and **▲/▼** button to select the mode between DISC and USB. You can press the eject button to eject the disc while selected DISC MODE.

On-Screen Display Function

Press the **OSD** button during playback to display the contents of the current disc on the screen.

A. Example for DVD:

a. Press **OSD** for the first time:

TITLE 01/03 CHAPTER 002/025
00:11:25

Title Number, Total Title Number, Chapter Number, Total Chapter Number of this Title of the disc currently being played will be shown on the screen, along with the elapsed time.

b. Press **OSD** for the second time:

TITLE REMAIN
01:20:25

c. Press **OSD** for the third time:

CHAPTER ELAPSED
00:20:15

d. Press **OSD** for the fourth time:

CHAPTER REMAIN
00:10:25

e. Press **OSD** for the fifth time:
The message on the screen will be cleared.

B. Example for VCD/SVCD/CD:

a. Press **OSD** for the first time:

SINGLE ELAPSED
00:00:25

b. Press **OSD** for the second time:

SINGLE REMAIN
00:04:25

c. Press **OSD** for the third time:

TOTAL ELAPSED
00:10:25

d. Press **OSD** for the fourth time:

TOTAL REMAIN
00:55:25

e. Press **OSD** for the fifth time:
The message on the screen will be cleared for SVCD and VCD.

C. Example for MP3:
Each time **OSD** is pressed, the message displayed on screen changes as follows:

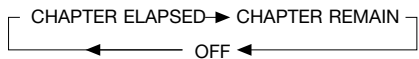

BASIC OPERATION

Multi-audio Language Function

A. DVD: Press AUDIO during playback. Each time the button is pressed, number of the audio soundtrack language changes on sequential order. Notes: The language number is different according to the disc. Some disc only contain one language soundtrack. When no different language soundtrack are recorded,  will be displayed at screen left top corner.

B. VCD/CD: Press AUDIO during playback. It is possible to switch the sound between monaural and stereo sound.



TITLE Menu Function

- A. DVD: If the DVD has multiple titles recorded on the disc. It can select preferred title from the title menu to start playback.
- a. Press TITLE during playback. The title menu is display.
 - b. Press the cursor button shown in TV screen, select preferred title by the cursor button and confirmed by ENTER key.

B. VCD: Press MENU button while the disc is playing, you can switch between "PBC on" and "PBC off" mode.

Multi-subtitle Language Function (For DVD only)

Press SUBTITLE during playback. Each time the button is pressed, number of the subtitle language changes in sequential order.

Notes: The language number is different according to the disc. Some discs only contain one subtitle language. When no different subtitle language are recorded,  will be displayed at screen left top corner.

Multi-angle Function (For DVD only)

Press ANGLE during playback. Each time the button is pressed, number of the angle changes in sequential order.

Notes: The angle number is different according to the disc. The function only work for discs having scenes recorded at different angles. When no different angle are recorded,  will be displayed at screen left top corner.

SETUP

INITIAL SETUP

--- MAIN PAGE---

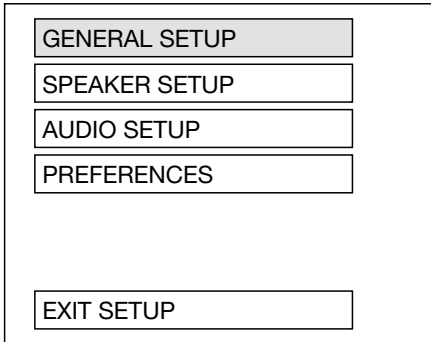

1. Press **SETUP** in the stop mode.
(Press the stop button twice to ensure the player under STOP mode.)

2. The initial SETUP menu is displayed.

3. Select the preferred item by using the ▲/▼ buttons.

4. Press ENTER buttons.

A. GENERAL SETUP

This setup page includes all the item of TV display & audio output feature. The detail please refer to **GENERAL SETUP MENU**.

B. SPEAKER SETUP

This is to activate the audio output from DOLBY AC3 5.1 DOWNMIX to 2 channel mode. Please refer to **SPEAKER SETUP MENU**.

C. AUDIO SETUP

This setup page includes all the items for AUDIO. Please refer to **AUDIO SETUP MENU**.

D. PREFERENCE SETUP

This setup page includes all the configuration of support feature. The detail please refer to **PREFERENCES SETUP MENU**.

GENERAL SETUP

--- GENERAL PAGE ---

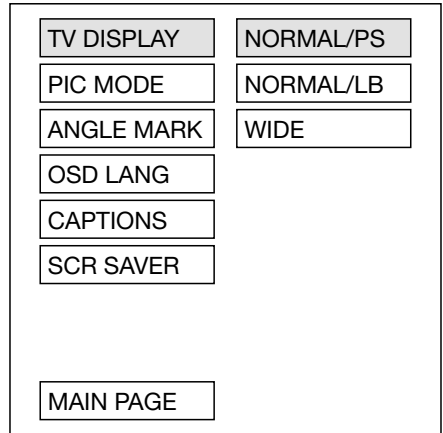

Video Material	TV Screen			
	4:3			Wide (16:9)
	Normal	Pan Scan	Letter-box	
4:3				
16:9				

1. TV DISPLAY SETUP

This is to select the appropriate TV aspect (4:3 or 16:9) according to the connected TV set.

Normal/PS (For 4:3 TV)

Played back in the PAN & SCAN style. (If connected to wide-screen TV, the left and right edges are cut off.)

Normal/LB (For 4:3 TV)

Played back in letterbox style. (If connected to wide-screen TV, black bands appear at top and bottom of the screen.)

Wide (For 16:9 TV)

Select when a wide-screen TV set is connected.

SETUP

--- GENERAL PAGE ---

TV DISPLAY	
PIC MODE	AUTO
ANGLE MARK	HI-RES
OSD LANG	N-FLICKER
CAPTIONS	
SCR SAVER	
MAIN PAGE	

2. PIC MODE SETUP

Select AUTO, the player PIC mode will depend on DVD disc.
Select HI-RES format for best image resolution.
Select N-FLICKER format on format on image or picture under noise affect.

--- GENERAL PAGE ---

TV DISPLAY	
PIC MODE	
ANGLE MARK	
OSD LANG	ENGLISH
CAPTIONS	FRENCH
SCR SAVER	GERMAN
	ITALIAN
	SPANISH
MAIN PAGE	

4. OSD LANG TYPE SETUP

Select the preferred OSD language by using the ▲ / ▼ buttons.

--- GENERAL PAGE ---

TV DISPLAY	
PIC MODE	
ANGLE MARK	ON
OSD LANG	OFF
CAPTIONS	
SCR SAVER	
MAIN PAGE	

3. ANGLE MARK DISPLAY SETUP

If it is set to ON, when the multi-angle DVD disc is playing, ∞ (the angle mark) will appear on the screen; if it is set to OFF, the mark will not appear.

--- GENERAL PAGE ---

TV DISPLAY	
PIC MODE	
ANGLE MARK	
OSD LANG	
CAPTIONS	ON
SCR SAVER	OFF
MAIN PAGE	

5. CAPTIONS SETUP

Activate the CAPTIONS feature by selecting ON. And release this feature by selecting OFF.

SETUP

--- GENERAL PAGE ---

TV DISPLAY	
PIC MODE	
ANGLE MARK	
OSD LANG	
CAPTIONS	
SCR SAVER	ON
	OFF
MAIN PAGE	

6. SCR SAVER SETUP

Select the SCR SAVER output ON/OFF.

SPEAKER SETUP

--- SPEAKER SETUP PAGE ---

DOWNMIX	LT/RT
	STEREO
MAIN PAGE	

This is to activate the audio output from DOLBY AC3 5.1 DOWNMIX to 2 channel mode. Select the preferred SPEAKER connection by using the cursor buttons.

- Select the LT/RT to activate the Dolby surround compatible output.
- Select the STEREO to activate simple stereo mode.

AUDIO SETUP

--- AUDIO SETUP ---

AUDIO OUT	ANALOG
OP MODE	SPDIF/RAW
DYNAMIC	SPDIF/PCM
LPCM OUTPUT	
MAIN PAGE	

1. AUDIO OUT

This is to activate the audio output from ANALOG mode to SPDIF/RAW mode to SPDIF/PCM mode.

--- AUDIO SETUP ---

AUDIO OUT	LINE OUT
OP MODE	RF REMOD
DYNAMIC	
LPCM OUTPUT	
MAIN PAGE	

2. OP MODE

There are two operating modes for the Dolby Digital decoder: LINE OUT and RF REMOD.

SETUP

--- AUDIO SETUP ---

AUDIO OUT	FULL 6/8 4/8 2/8 OFF
OP MODE	
DYNAMIC	
LPCM OUTPUT	
MAIN PAGE	

3. DYNAMIC RANGE CONTROL

Select DRC and adjust the dynamic range of a Dolby Digital encoded program. There are 8 steps between full compression and off compression.

--- AUDIO SETUP ---

AUDIO OUT	
OP MODE	
DYNAMIC	
LPCM OUTPUT	LPCM 48K
	LPCM 96K
MAIN PAGE	

4. LPCM OUTPUT

Select the LPCM OUTPUT between LPCM 48K and LPCM 96K.

PREFERENCES SETUP

--- PREFERENCES PAGE ---

TV TYPE	AUTO
AUDIO	NTSC
SUBTITLE	PAL
DISC MENU	
PARENTAL	
PASSWORD	
DEFAULTS	
SMART NAV	
MAIN PAGE	

1. TV TYPE SETUP

This player can play discs recorded in either PAL or NTSC format. Select NTSC format, when you connected to NTSC TV. Select PAL format, when you connected to PAL TV. Select AUTO format, the player TV output format will according to the DVD disc format.

--- PREFERENCES PAGE ---

TV TYPE	
AUDIO	ENGLISH
SUBTITLE	FRENCH
DISC MENU	SPANISH
PARENTAL	CHINESE
PASSWORD	JAPANESE
DEFAULTS	GERMAN
SMART NAV	ITALIAN
MAIN PAGE	

2. AUDIO LANGUAGE SETUP

Select the preferred AUDIO sound-track by using the cursor buttons.

SETUP

--- PREFERENCES PAGE ---

TV TYPE	
AUDIO	ENGLISH
SUBTITLE	FRENCH
DISC MENU	SPANISH
PARENTAL	CHINESE
PASSWORD	JAPANESE
DEFAULTS	GERMAN
SMART NAV	ITALIAN
MAIN PAGE	OFF

3. SUBTITLE LANGUAGE SETUP

Select the preferred SUBTITLE language by using the cursor buttons.

--- PREFERENCES PAGE ---

TV TYPE	1 G
AUDIO	2
SUBTITLE	3 PG
DISC MENU	4 PG 13
PARENTAL	5
PASSWORD	6 PG-R
DEFAULTS	7 NC-17
SMART NAV	8 ADULT
MAIN PAGE	NO_PARENTAL

5. PARENTAL

Select suitable parental guidance by the cursor buttons and confirmed by pressing ENTER button.

--- PREFERENCES PAGE ---

TV TYPE	
AUDIO	
SUBTITLE	ENGLISH
DISC MENU	FRENCH
PARENTAL	SPANISH
PASSWORD	CHINESE
DEFAULTS	JAPANESE
SMART NAV	GERMAN
MAIN PAGE	ITALIAN

4. DISC MENU LANGUAGE SETUP

Select the preferred DISC MENU language by using the cursor buttons.

--- PREFERENCES PAGE ---

TV TYPE	
AUDIO	
SUBTITLE	
DISC MENU	
PARENTAL	
PASSWORD	CHANGE
DEFAULTS	
SMART NAV	
MAIN PAGE	

6. PASSWORD

Select the change and press ENTER button. Type the old password (The initial factory code is **3308**) and key in 4 characters password now you want to use, and retype again to confirm key in correctly.

SETUP

--- PREFERENCES PAGE ---

TV TYPE
AUDIO
SUBTITLE
DISC MENU
PARENTAL
PASSWORD
DEFAULTS
SMART NAV
MAIN PAGE

RESET

7. DEFAULTS

Select reset to become factory initial setting.

--- PREFERENCES PAGE ---

TV TYPE
AUDIO
SUBTITLE
DISC MENU
PARENTAL
PASSWORD
DEFAULTS
SMART NAV
MAIN PAGE

NO MENU
WITH MENU

8. SMART NAV

In this item, you can select NO MENU mode or WITH MENU mode.

DEFAULTS TABLE

General Setup	TV Display	Normal/PS
	PIC Mode	AUTO
	Angle Mark	ON
	OSD Language	English
	Captions	ON
	SCR Saver	ON
Speaker Setup	Downmix	Stereo
Audio Setup	Audio Out	Analog
	OP Mode	Line Out
	Dynamic	
	LPCM Out	LPCM 96K
Preferences	TV Type	AUTO
	Audio	English
	Subtitle	English
	DISC Menu	English
	Parental	NO PARENTAL
	Password	3308
	Smart Nav	With Menu

SPECIFICATIONS

Supply voltage : 12V DC (11V-15V)
 Current consumption : Less than 10A
 Signal system : Compositive video 1.0Vp-p 75Ω
 Discs played : (1) DVD-VIDEO disc
 5”(12 cm) single-sided, single-layer
 5”(12 cm) single-sided, double-layer
 (2) Compact disc (CD-DA, VIEDO CD)
 5”(12 cm) disc
 Audio Signal Output : 2ch & 4ch line out
 Characteristics : (1) Frequency Response: 20 Hz-20 kHz
 (2) S/N Ratio: 90 dB (JIS)
 (3) Wow and Flutter: Below measurable limits

	For 3 Bands (Europe)	For 2 Bands (Europe)	For 2 Bands (U.S.A.)
	FM	FM	FM
Frequency Coverage	: 87.5 to 108 MHz	87.5 to 108 MHz	87.5 to 107.9 MHz
IF	: 10.7 MHz	10.7 MHz	10.7 MHz
Sensitivity (S/N = 30 dB)	: 15 dBu	15 dBu	15 dBu

	MW	MW	AM
Frequency Coverage	: 522 to 1620 KHz	522 to 1620 KHz	530 to 1710 KHz
IF	: 450 KHz	450 KHz	450 KHz
Sensitivity (S/N = 20 dB)	: 40 dBu	40 dBu	40 dBu

	LW
Frequency Coverage	: 144 to 290 KHz
IF	: 450 KHz
Sensitivity (S/N = 20 dB)	: 45 dBu

Note:

Specifications and design are subject to modification, without notice, due to improvements in technology.

TROUBLE SHOOTING

Before going through the check list, check wiring connection. If any of the problems persist after check list has been made, consult your nearest service dealer.

Symptom	Cause	Solution
No power.	The car ignition switch is not on.	If the power supply is properly connected to the car accessory terminal, switch the ignition key to "ACC".
	The fuse is blown.	Replace the fuse.
Disc cannot be loaded or ejected.	Presence of disc inside the player	Remove the disc in the player, Then put a new one
	Inserting the disc in reverse direction.	Insert the compact disc with the label facing upward.
	The disc is extremely dirty or defective	Clean the disc or try to play a new one.
	Temperature inside the car is too high.	Cool off or until the ambient temperature return to normal.
	Condensation.	Leave the player off for an hour then try again.
No sound.	Volume is in minimum.	Adjust volume to a desired level.
	Wiring is not properly connected.	Check wiring connection.
Sound skips.	The installation angle is more than 30 degrees.	Adjust the installation angle less than 30 degrees.
	The disc is extremely dirty or defective disc.	Clean the compact disc, then try to play a new one.
The operation keys do not work.	The built-in microcomputer is not operating properly due to noise.	Press the RESET button. Front panel is not properly fixed into its place.
The radio does notwork.	The antenna cable is not connected.	Insert the antenna cable firmly.
	The signals are too weak.	Select a station manually.

This product incorporates copyright protection technology that is protected by method claims of certain U.S. patents and other intellectual property rights owned by Macrovision Corporation and other rights owners. Use of this copyright protection technology must be authorized by Macrovision Corporation, and is intended for home and other limited viewing uses only unless otherwise authorized by Macrovision Corporation. Reverse engineering or disassembly is prohibited.

Free Manuals Download Website

<http://myh66.com>

<http://usermanuals.us>

<http://www.somanuals.com>

<http://www.4manuals.cc>

<http://www.manual-lib.com>

<http://www.404manual.com>

<http://www.luxmanual.com>

<http://aubethermostatmanual.com>

Golf course search by state

<http://golfingnear.com>

Email search by domain

<http://emailbydomain.com>

Auto manuals search

<http://auto.somanuals.com>

TV manuals search

<http://tv.somanuals.com>