

## OWNER'S MANUAL

### Mobile Video System

---

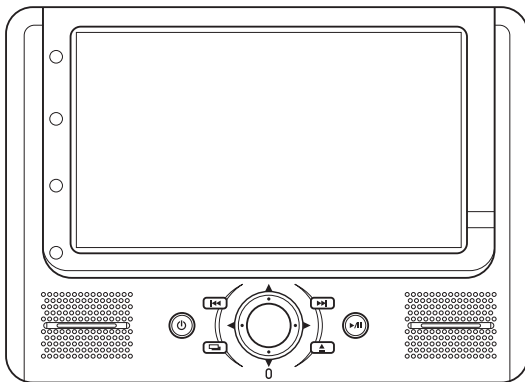
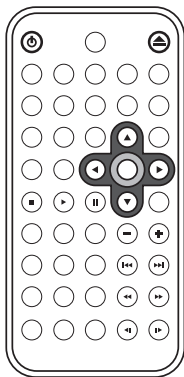

- **Digital Audio Out-Coaxial**
- **DVD Player**
- **Multi Color TFT Monitor**
- **Multi-subtitle Languages Function**
- **Multi-audio Languages Function**
- **Multi-angle Function**
- **Parental Control**
- **Remote Control**

# FEATURES

## **Compatible with PAL DVD (Video CD) and NTSC DVD (Video CD)**

This player can play discs recorded in either PAL or NTSC format.

- A single LSI chip now integrates all major DVD playback circuit functions including MPEG2 decoder, video D/A converter, and audio decoders.
- L/R stereo analog audio outputs for connection to existing head unit aux inputs. Video output is composite video.
- Supplied remote handles multi-function software (multi-language audio-track/subtitle, multi-angle, multi-story, etc.), plus all basic functions.

## **Use Authorized Service Centres**

Do not attempt to disassemble or adjust this precision product. Please refer to the Service Centre list included with this product for service assistance.

# USE THIS PRODUCT SAFELY

## **When Driving**

Keep the volume level low enough to be aware of road and traffic conditions.

## **When Car Washing**

Do not expose the product to water or excessive moisture. This could cause electrical shorts, fire or other damage.

## **When Parked**

Parking in direct sunlight can produce very high temperatures inside your vehicle. Give the interior a chance to cool down before starting playback.

## **Use the Proper Power Supply**

This product is designed to operate with a 12 volt DC, negative ground battery system (the regular system in a North American car).

## **Protect the Disc Mechanism**

Avoid inserting any foreign objects into the slot of this player.

Failure to observe this may cause malfunction due to the precise mechanism of this unit.

# CONTENTS

---

<b>Safety Information</b> .....	<b>4</b>
<b>Disc Notes</b> .....	<b>5</b>
<b>The Player</b> .....	<b>6</b>
<b>Installation</b> .....	<b>7</b>
<b>Electric Connection</b> .....	<b>8</b>
<b>Remote Control</b> .....	<b>9</b>
Location and Function of Keys .....	9
Preparing the Remote Control .....	11
<b>Loading/Ejecting a disc</b> .....	<b>11</b>
Loading a disc .....	11
Ejecting a disc .....	11
<b>Operation</b> .....	<b>12</b>
Basic Play .....	12
Menu Function .....	14
On-Screen Display Function .....	15
Multi-audio Language Function .....	16
Title Menu Function .....	16
Multi-subtitle Language Function .....	16
Multi-angle Function .....	16
MP3 Disc Play .....	17
<b>Setup</b> .....	<b>18</b>
Initial Setup .....	18
General Setup .....	18
Speaker Setup .....	20
Audio Setup .....	20
Preferences Setup .....	21
Defaults Table .....	23
<b>Trouble Shooting</b> .....	<b>24</b>
<b>Specifications</b> .....	<b>25</b>

# SAFETY INFORMATION

---

## CAUTION:

MOBILE DVD PLAYER IS A CLASS I LASER PRODUCT. HOWEVER THIS MOBILE DVD PLAYER USES A VISIBLE/INVISIBLE LASER BEAM WHICH COULD CAUSE HAZARDOUS RADIATION EXPOSURE IF DIRECTED. BE SURE TO OPERATE THE MOBILE DVD PLAYER CORRECTLY AS INSTRUCTED.

USE OF CONTROLS OR ADJUSTMENTS OR PERFORMANCE OF PROCEDURES OTHER THAN THOSE SPECIFIED HEREIN MAY RESULT IN HAZARDOUS RADIATION EXPOSURE.

DO NOT OPEN COVERS AND - DO NOT REPAIR YOURSELF. REFER SERVICING TO QUALIFIED PERSONNEL.

## WARNING:

- TO REDUCE THE RISK OF FIRE OR ELECTRIC SHOCK, DO NOT EXPOSE THIS EQUIPMENT TO RAIN OR MOISTURE.
- TO REDUCE THE RISK OF FIRE OR ELECTRIC SHOCK, AND ANNOYING INTERFERENCE, USE ONLY THE RECOMMENDED ACCESSORIES.
- THIS DEVICE IS INTENDED FOR CONTINUOUS OPERATION.

This product incorporates copyright protection technology that is protected by method claims of certain U.S. patents and other intellectual property rights owned by Macrovision Corporation and other rights owners. Use of this copyright protection technology must be authorized by Macrovision Corporation, and is intended for home and other limited viewing uses only unless otherwise authorized by Macrovision Corporation. Reverse engineering or disassembly is prohibited.

## Region Management Information

Region Management Information:

This Mobile DVD Player is designed and manufactured to respond to the Region Management Information that is recorded on a DVD disc. If the Region number described on the DVD disc does not correspond to the Region number of this Mobile DVD Player, this Mobile DVD Player cannot play this disc.

# DISC NOTES

## Disc formats supported by this player



**DVD**  
12 cm disc  
(Single-sided disc only)



**Video CD**  
12 cm disc



**CD**  
12 cm disc



**MP3**  
12 cm disc

## Discs which cannot be played with this player

- DVD-ROM
- DVD-R/DVD-RAM
- CDV
- CD-G

## Handling and Cleaning

- Dirt, dust, scratches and warping disc will cause misoperation.
- Do not place stickers or make scratches on discs.
- Do not warp discs.
- A disc should always be kept in its case when not in use to prevent from damaging.
- Do not place discs in the following places:
  1. Direct sunlight
  2. Dirty, dusty and damp areas
  3. Near car heaters
  4. On the seats or dashboard

## Disc Cleaning

Use a dry soft cloth to wipe the surface. If the disc is quite dirty, use a soft cloth slightly moistured with isopropyl (rubbing) alcohol. Never use solvents such as benzine, thinner or conventional record cleaners as they may mar the surface of the disc.

### Note:

A disc may become somewhat scratched (although not enough to make it unusable) depending on your handle it and conditions in the usage environment.

Note these scratches are not an indication of any problem with the player.

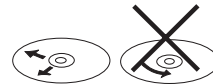
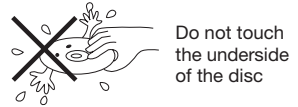
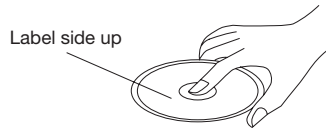

Wipe the disc from center toward the outside edge

## Preparing New Discs with Rough Spots

A new disc may have rough edges on its inside and outside edges. If a disc with rough edges is used, the proper setting will not be performed and the player will not play the disc. Therefore, remove the rough edges in advance by using a ball point pen or pencil as shown on the right. To remove the rough edges, press the side of the pen or pencil against the inside and outside edges of the disc.

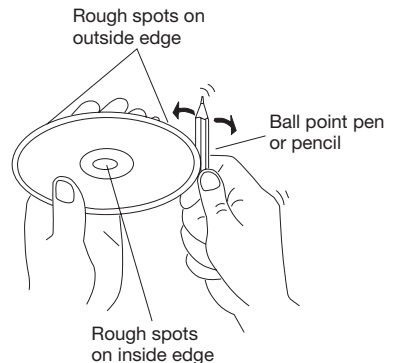

# THE PLAYER

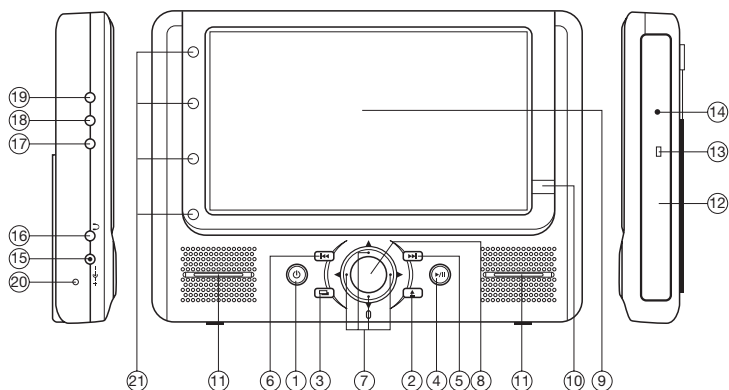

- |   |   |
|---|---|
| 1. POWER /STOP                                | 13. Data reading indicator  |
| 2. EJECT(▲)                                   | 14. Button for compulsively ejecting disc   |
| 3. SETUP                                      | 15. DC 12V IN   |
| 4. PLAY/PAUSE (▶/⏸) MODE                      | 16. Jack for earphone   |
| 5. NEXT(▶▶)                                   | 17. AV IN   |
| 6. PREV(◀◀)                                   | 18. DIGITAL AUDIO   |
| 7. ◀/▶, ▲/▼ cursor buttons<br>◀(VOL+)/▶(VOL-) | 19. AV OUT  |
| 8. OK   | 20. Reset button  |
| 9. 7 inch TFT Color Monitor                   | 21. Infrared transmitting area<br>(For the unit with infrared transmitting function only) |
| 10. Remote Sensor                             |   |
| 11. Speakers                                  |   |
| 12. Disc tray                                 |   |

## INSTALLATION

---

You can pull out the stand on the back of the DVD unit to place the unit on the desired position.

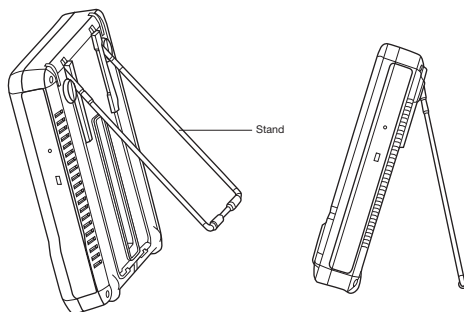

# ELECTRIC CONNECTION

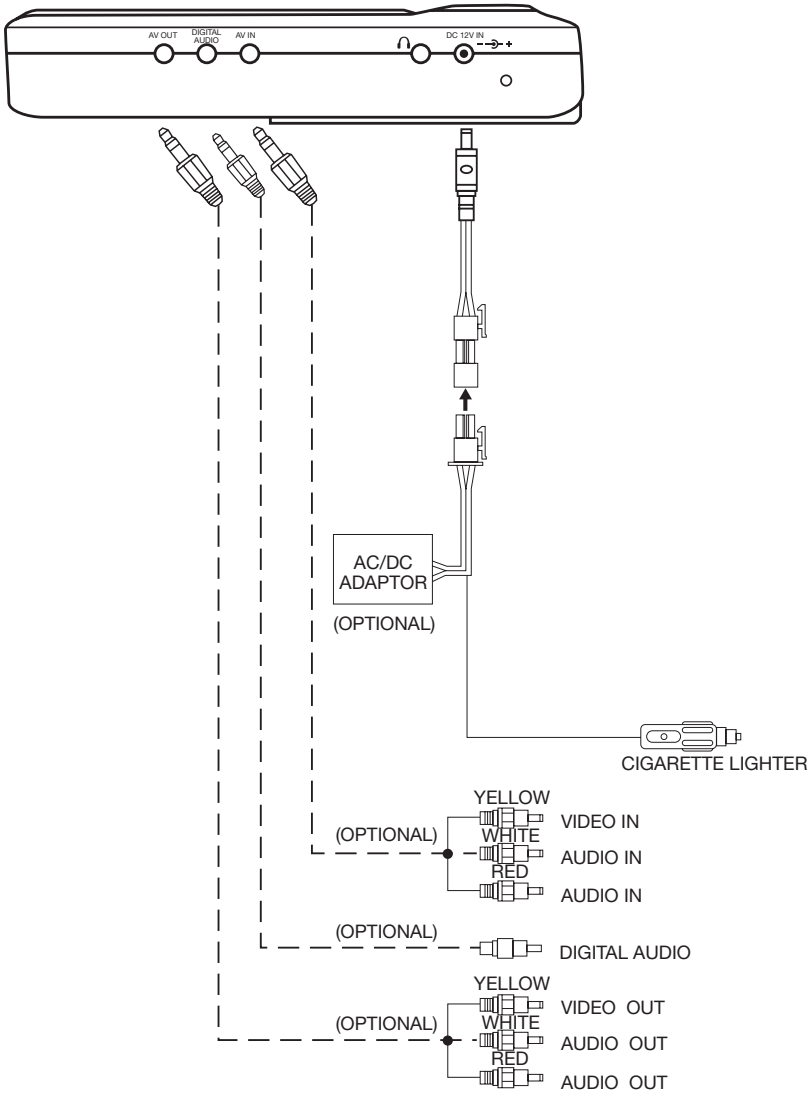



# REMOTE CONTROL

## LOCATION AND FUNCTION OF KEYS

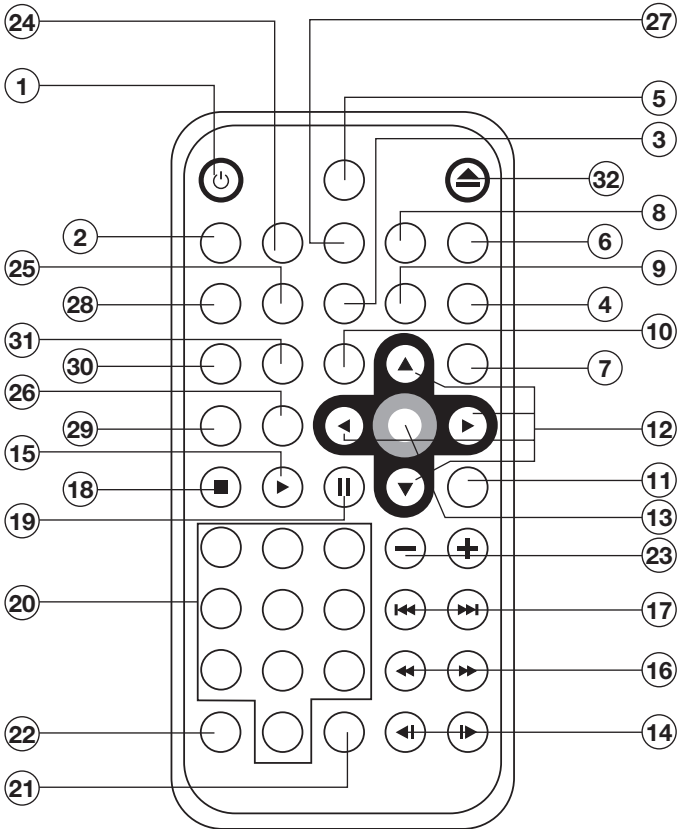

## REMOTE CONTROL

---

1. POWER OFF When the unit is on, press the button to turn the unit off.
2. MUTE Press to mute the sound.
3. SUB-T Changing of the SUBTITLE language on multi-subtitle language DVD disc.
4. ANGLE Changing of the view angle on multi-angle DVD disc.
5. DISPLAY Display statistical disc information during playback.
6. MODE Changing between DVD mode and AV mode.
7. SETUP Display the SETUP menu.
8. P/N Switch between PAL mode and NTSC mode.
9. AUDIO Changing of the AUDIO soundtrack on multi-audio soundtrack DVD disc. Changing of the sound mode of the VCD/CD disc.
10. TITLE Display the TITLE menu that is stored in DVD disc.
11. MENU Display the adjustment items, such as Bright, Contrast, Color, Tint, Screen and TX (for the unit with infrared transmitting function or for the unit with FM transmitter function).
12. ◀/▶ , ▲/▼ In case of MENU mode, ◀/▶ , ▲/▼ buttons served as cursor buttons to select item left/right, ahead/back.
13. OK Confirm the Track/Chapter selected with the numeric buttons or selected with the cursor buttons on screen display.
14. ⏪ / ◀ Changing for slow forward/reverse playback motion.
15. ▶ Press to play the disc.
16. ◀◀ / ▶▶ Press ▶▶ to search forward rapidly & ◀◀ to search reverse rapidly.
17. ▶▶/◀◀ Press ▶▶ to skip to the next track & press ◀◀ to skip back one track.
18. ■ Press it to stop playback.
19. ⏸ Press it to pause playback.
20. 0 - 9 Numeric buttons
21. 10+ Tens digit select button, cooperatively used with numeric buttons.
22. CLEAR When you input a number in error, press the button to clear it.
23. VOLUME+/- Press VOLUME+/- button to increase or decrease the volume level. Adjust the corresponding item when press MENU to select.
24. ZOOM Allows the picture to be increased in size.
25. RESUME When in stop mode, press the button, then play can be resumed from the stop point (only for CD).
26. GOTO Disc search button, cooperatively used with numeric buttons.
27. PBC Changing between PBC ON and PBC OFF on the disc.
28. SHUFFLE Allows the track played in random order.
29. PROGRAM Allows the track played in the order you programmed.
30. REPEAT Switch the Repeat mode of discs.
31. A-B A-B repeat allows a passage to be repeated continuously.
32. ▲ (EJECT) Press to eject the disc.

# REMOTE CONTROL

---

## Preparing the Remote Control

### *Inserting the Batteries*

1. Open the battery compartment cover.
2. Insert the new batteries. Make sure that the positive and negative terminals of the batteries are oriented indicated.
3. Close the cover  
Battery: one button cell lithium battery.

### *Using the Remote Control*

Face the remote control towards the player front face IR mark (remote control signal receiver).

Operation angle: About  $\pm 30$  degree in each the direction of the front of the IR mark.

## LOADING / EJECTING A DISC

---

### **Loading a Disc**

When you have installed the unit and all connections have completed, you can load a disc as follows:

1. Turn the ignition on the accessory position.
2. Press the POWER button on the front panel.
3. Press  $\blacktriangle$  (EJECT) button to eject the disc tray. The disc door is on the side of the unit.
4. Place the disc with printed side facing up on the tray, and then close the disc door.
5. The player will start playback automatically.

### **Ejecting a Disc**

Press  $\blacktriangle$  (EJECT) button to eject the disc.

**Note:** When the disc cannot be ejected by pressing  $\blacktriangle$  (EJECT) button (when the unit can't work normally or has no power), you can activate the button on the side of the unit with a pointed object to eject the disc compulsively.

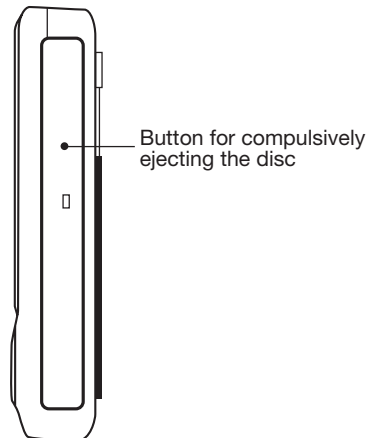



# OPERATION

## A-B

A-B repeat allows a passage to be repeated continuously. Press **A-B** button at the start of the required passage, then press **A-B** button again at the end of the passage. To revert to normal playing, press **A-B** button again. Each time the button pressed, the screen will display as follows:

A TO B SET A → A TO B SET B → A TO B CANCELLED

## Disc Search (GOTO)

FOR DVD

Press **GOTO** button twice, the screen will display the following message:

```
TITLE 01/01 TIME -- : -- : --
00:00:25
```

You can select the item you want to watch through TIME setting by using numeric buttons and ENTER key.

FOR CD/VCD (WITH PBC OFF):

Press **GOTO** button once, the screen will display the following message:

```
GOTO -- : --
00:00:25
```

Use numeric buttons to input the time directly.

## ZOOM

Allows the picture to be increased in size. Press **ZOOM** to toggle among 1.5 scale, 2.0 scale and 3.0 scale.

During Zoom mode, press **▲ / ▼**, **◀ / ▶** buttons to move pictures up, down, left or right direction.

## SHUFFLE

Press **SHUFFLE** button, track selection will be made in random order. The display screen will show "SHUFFLE ON" on the screen. Press **SHUFFLE** button again, "SHUFFLE OFF" appears and release the mode.

## PROGRAM

In stop mode, press **PROGRAM** button, the screen will display "PROGRAM P00:00". For example: press numeric button 4 and **▶** button, "PROGRAM P01:04" appears. It means track 4 will be played first.

## MODE SELECTION

Press and hold **PLAY/PAUSE (MODE)** button on the front panel of the unit for several seconds or press **MODE** button on the remote control to select among DVD and AV mode.

## VOLUME LEVEL ADJUSTMENT

Press and hold **▶ (VOL+)**/ **◀ (VOL-)** on the front panel for several seconds or press **VOLUME +/-** on the remote control to increase or decrease the volume level.

## JACK FOR EARPHONE (🎧)

There are one jack for earphone. You can connect an earphone to the jack to receive sound signal.

## REMOTE SENSOR

Point the remote handset to the remote sensor on the front panel. Receive the signal from remote handset.

## TURNING THE UNIT ON/OFF

When the power is off, press the **⏻ (POWER)** button on the front panel to turn on the unit.

When the power is on, press **POWER OFF** button on the remote control to turn off the unit.

## OPERATION

When the power is on, press **⏻ (POWER)** button on the front panel for several seconds will turn off the unit. Shortly pressing **⏻ (POWER)** button on the front panel is STOP function, and the function is the same with **■** button on remote control.

### RESET FUNCTION

Reset button and must be activated with either a ballpoint pen or thin metal object. The reset button is to be activated for the following reasons:

- Initial installation of the unit when all wiring is completed.
- All the function buttons do not operate.
- Error symbol on the display.

### INFRARED TRANSMITTING WINDOW (For the unit with infrared transmitting function only)

There are four infrared transmitting lights inside the window on the unit, the user can put on the infrared wireless headphones supplied with the unit and hear the sound signal emitting from the window.

### MENU FUNCTION

Press **SETUP** button on the unit shortly or press **MENU** on the remote control during DVD, AV mode to display the adjustment items on the screen.  
(For the unit with PAL system):

MENU	
BRIGHT	32
CONTRAST	32
COLOR	32
SCREEN	16:9
TX	OFF

(For the unit with NTSC system):

MENU	
BRIGHT	32
CONTRAST	32
COLOR	32
TINT	32
SCREEN	16:9
TX	OFF

Press **▲ / ▼** buttons on the DVD unit or **▲ / ▼** buttons on the remote control to select among Bright, Contrast, Color and Tint (For the unit with NTSC system) items and etc. Press **◀ / ▶** buttons on the DVD unit shortly or press **◀ / ▶** buttons on the remote control to adjust the corresponding item.

**Note:** When you set the TV TYPE item to "PAL" in "PREFERENCES SETUP", there is no "TINT" item to display. In Screen item, you can select appropriate TV aspect ratio (4:3 or 16:9) using the **◀ / ▶** buttons on the unit or **◀ / ▶** buttons on the remote control. The TX item is effective when the unit has the infrared transmitting function or the FM transmitter function.

- For the unit with infrared transmitting function:  
In TX item, there is ON or OFF to be selected. Press **◀ / ▶** buttons to select ON or OFF. When set it to ON, the sound signal can be emitted from the infrared transmitting window on the unit and you can use the infrared wireless headphone to hear the sound signal.
- For the unit with FM transmitter function:  
In TX item, use **◀ / ▶** buttons to select among OFF/90.1/98.1/106.1. (These three transmitting frequency are factory defaults.) When selected one frequency, press **OK** button, then there is red background shown on the selected frequency. Then use **◀ / ▶** buttons to adjust the frequency, when selected the desired frequency point, press **OK** button to confirm (then the red background on the frequency digits disappears.). Then the transmitting frequency of the unit is the frequency just set.

**Note:** The unit can't have the infrared transmitting function and the FM transmitter function together.

# OPERATION

## On-Screen Display Function

Press the **DISPLAY** button during playback to display the contents of the current disc on the screen.

Example:

DVD:

(1) Press **DISPLAY** for the first time:

```
TITLE 01/03 CHAPTER 002/025
00:02:25
```

Title Number, Total Title Number, Chapter Number, Total Chapter Number of this Title of the disc currently being played will be shown on the screen, along with the elapsed time.

(2) Press **DISPLAY** for the second time:

```
TITLE REMAIN
01:46:58
```

(3) Press **DISPLAY** for the third time:

```
CHAPTER ELAPSED
00:00:24
```

(4) Press **DISPLAY** for the fourth time:

```
CHAPTER REMAIN
00:01:39
```

(5) Press **DISPLAY** for the fifth time:  
The message on the screen will be cleared.

VCD:

(1) Press **DISPLAY** for the first time:

```
SINGLE ELAPSED
00:00:25
```

(2) Press **DISPLAY** for the second time:

```
SINGLE REMAIN
00:03:15
```

(3) Press **DISPLAY** for the third time:

```
TOTAL ELAPSED
00:00:25
```

(4) Press **DISPLAY** for the fourth time:

```
TOTAL REMAIN
00:40:35
```

(5) Press **DISPLAY** for the fifth time:

The message on the screen will be cleared.

CD:

(1) Press **DISPLAY** for the first time:

```
SINGLE ELAPSED
00:00:25

TRACK : 01/14
```

(2) Press **DISPLAY** for the second time:

```
SINGLE REMAIN
00:03:15

TRACK : 01/14
```

(3) Press **DISPLAY** for the third time:

```
TOTAL ELAPSED
00:00:25

TRACK : 01/14
```

# OPERATION

- (4) Press **DISPLAY** for the fourth time:

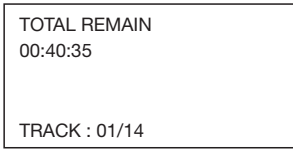

- (5) Press **DISPLAY** for the fifth time:  
The message on the screen will be cleared.

## MP3 (When set to NO MENU in SMART NAV item):

- (1) Press **DISPLAY** for the first time:

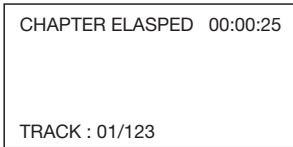

- (2) Press **DISPLAY** for the second time:

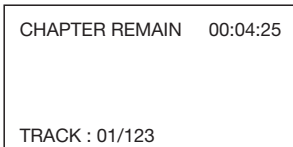

- (3) Press **DISPLAY** for the third time:  
The message on the screen will be cleared.

## Multi-audio Language Function For DVD:

Press **AUDIO** on the remote control during playback. Each time the button is pressed, the audio soundtrack language changes on sequential order.

Notes:

- The language number is different according to the disc.
- Some disc only contain one language soundtrack.
- When no different language soundtrack are recorded,  will be displayed at screen left top corner.

## For VCD/CD:

Press **AUDIO** on the remote control during playback. It is possible to switch

the sound between monaural and stereo sound.



## TITLE Menu Function (For DVD only)

If the DVD has multiple titles recorded on the disc. It can select preferred title from the title menu to start playback.

- Press **TITLE** during playback.  
The title menu is display.
- Press the cursor button shown in screen display, select preferred title by the cursor button and confirmed by **OK** button on the DVD unit or on the remote control.

## Multi-subtitle Language Function (For DVD only)

Press **SUB-T** during playback.

Each time the button is pressed, the subtitle language changes in sequential order.

Notes:

- The language number is different according to the disc.
- Some discs only contain one subtitle language.
- When no different subtitle language are recorded,  will be displayed at screen left top corner.

## Multi-angle Function (For DVD only)

Press **ANGLE** during playback.

Each time the button is pressed, the angle changes in sequential order.

Notes:

- The angle number is different according to the disc.
- The function only works for discs having scenes recorded at different angles.
- When no different angle is recorded,  will be displayed at screen left top corner.









# OPERATION

## MP3 Disc Play

MP3 disc is playing as the format of FOLDER.

For example:

SMART NAVI	
 ROOT	
 CD01	MP3 001 PLUMT
 CD02	MP3 002 RZID
 CD03	MP3 003 ASCIS
 CD04	MP3 004 DCYI
 CD05	MP3 005 BFZ
PLAY MODE	DISC

In stop mode, use **▲ / ▼**, **◀ / ▶** on the remote control to select the item or folder (such as CD01, CD02...), and press **OK** button on the DVD unit or on the remote control to confirm, then select the desired track (such as 001 PLUMT, 002 RZID...) on the current folder to play.

Pressing **REPEAT** button repeatedly can select three kinds of repeat play mode.  
REP-ONE:

Play the same song over and again.

FOLDER REPEAT:

Play all songs in the current directory in sequence, over and again.

FOLDER:

Play all songs in the current directory once.

When select PLAY MODE, press **▲ / ▼** to change between the following mode:

SINGLE → REP-ONE → FOLDER → FOLDER REP →  
DISC SCAN → **DISC** → DISC REP →  
SHUFFLE ON → PROGRAM PXXX

In the playback, use **▶▶** or **◀◀** to skip an item ahead or back.

**◀◀** : Rapid reverse, **▶▶** : Rapid advance.

Note: The FOLDER cannot be selected during playing. It can be selected after **■** (Stop) button pressed.

# SETUP

## INITIAL SETUP

SETUP MENU --- MAIN PAGE

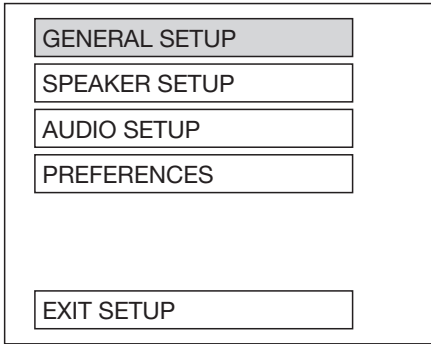

1. Press **SETUP** on the remote control in the stop mode. (Press the **■** button twice to ensure that the player is in STOP mode.)
2. The initial SETUP menu is displayed.
3. Select the preferred item by using the **▲/▼** buttons.
4. Press OK buttons.
  - a. **GENERAL SETUP**  
This setup page includes all the item of TV display & audio output feature. The detail please refer to **GENERAL SETUP MENU**.
  - b. **SPEAKER SETUP**  
This is to activate the audio output from DOLBY AC3 5.1 DOWNMIX to 2 channel mode. Please refer to **SPEAKER SETUP MENU**.
  - c. **AUDIO SETUP**  
This setup page includes all the items for AUDIO. Please refer to **AUDIO SETUP MENU**.
  - d. **PREFERENCE SETUP**  
This setup page includes all the configuration of support feature. The detail please refer to **PREFERENCES SETUP MENU**.

## GENERAL SETUP

--- GENERAL PAGE ---

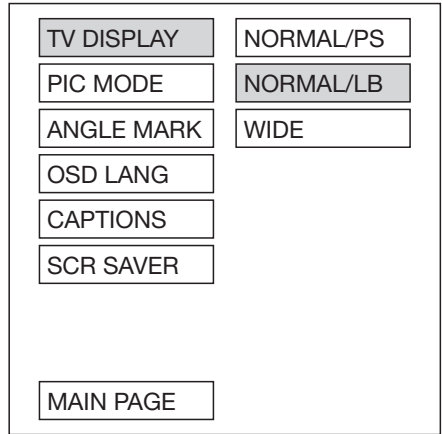

Video Material	TV Screen			
	4:3			Wide (16:9)
	Normal	Pan Scan	Letter-box	
4:3				
16:9				

### TV display setup

This is to select the appropriate TV aspect (4:3 or 16:9) according to the connected TV set.

#### Normal/PS (For 4:3 TV)

Played back in the PAN & SCAN style. (If connected to wide-screen TV, the left and right edges are cut off.)

#### Normal/LB (For 4:3 TV)

Played back in letterbox style. (If connected to wide-screen TV, black bands appear at top and bottom of the screen.)

#### Wide (For 16:9 TV)

Select when a wide-screen TV set is connected.

# SETUP

--- GENERAL PAGE ---

TV DISPLAY	
PIC MODE	AUTO
ANGLE MARK	HI-RES
OSD LANG	N-FLICKER
CAPTIONS	
SCR SAVER	
MAIN PAGE	

## PIC mode setup

Select AUTO, the player PIC mode will depend on DVD disc.  
Select HI-RES format for best image resolution.  
Select N-FLICKER format on image or picture with noise or distortion.

--- GENERAL PAGE ---

TV DISPLAY	
PIC MODE	
ANGLE MARK	
OSD LANG	ENGLISH
CAPTIONS	FRENCH
SCR SAVER	GERMAN
	ITALIAN
	SPANISH
MAIN PAGE	

## OSD LANG type setup

Select the preferred OSD (On Screen Display) language by using the ▲ / ▼ buttons.

--- GENERAL PAGE ---

TV DISPLAY	
PIC MODE	
ANGLE MARK	ON
OSD LANG	OFF
CAPTIONS	
SCR SAVER	
MAIN PAGE	

## ANGLE MARK display setup

If it is set to ON, when the multi-angle DVD disc is playing, ∞ (the angle mark) will appear on the screen; if it is set to OFF, the mark will not appear.

--- GENERAL PAGE ---

TV DISPLAY	
PIC MODE	
ANGLE MARK	
OSD LANG	
CAPTIONS	ON
SCR SAVER	OFF
MAIN PAGE	

## CAPTIONS setup

When play DVD disc, activate the CAPTIONS feature by selecting ON and the captions (such as the actor dialogue) appear on the screen; deactivate this feature by selecting OFF and the captions will not appear.

# SETUP

--- GENERAL PAGE ---

TV DISPLAY	
PIC MODE	
ANGLE MARK	
OSD LANG	
CAPTIONS	
SCR SAVER	ON
	OFF
MAIN PAGE	

## SCR SAVER setup

Select the SCR SAVER ON/OFF.

## SPEAKER SETUP

--- SPEAKER SETUP PAGE ---

DOWNMIX	LT/RT
	STEREO
MAIN PAGE	

This is to activate the audio output from DOLBY AC3 5.1 DOWNMIX to 2 channel mode. Select the preferred SPEAKER connection by using the cursor buttons.

- Select the LT/RT to activate the Dolby surround compatible output.
- Select the STEREO to activate simple stereo mode.

## AUDIO SETUP

--- AUDIO SETUP ---

AUDIO OUT	ANALOG
OP MODE	SPDIF/RAW
DYNAMIC	SPDIF/PCM
LPCM OUTPUT	
MAIN PAGE	

## AUDIO OUT

- Select ANALOG mode to activate analog audio output.
- Select SPDIF/RAW mode to activate raw digital audio output. And the digital audio format depends on the disc record format.
- Select SPDIF/PCM mode to activate PCM digital audio output.

--- AUDIO SETUP ---

AUDIO OUT	
OP MODE	LINE OUT
DYNAMIC	RF REMOD
LPCM OUTPUT	
MAIN PAGE	

## OP MODE

- LINE OUT: Line out mode, with digital dialog normalization.
  - RF REMOD: RF remodulation mode, with heavy compression and digital dialog normalization.
- It is recommended to select LINE OUT mode.

# SETUP

## --- AUDIO SETUP ---

AUDIO OUT	
OP MODE	
<b>DYNAMIC</b>	
LPCM OUTPUT	
	FULL
	6/8
	4/8
	2/8
	OFF
MAIN PAGE	

### Dynamic Range Control

Select DYNAMIC and adjust the dynamic range of a Dolby Digital encoded program. There are 8 steps between full compression and off compression.

## --- AUDIO SETUP ---

AUDIO OUT	
OP MODE	
DYNAMIC	
LPCM OUTPUT	LPCM 48K
	<b>LPCM 96K</b>
MAIN PAGE	

### LPCM OUTPUT

Select the LPCM (Line Pulse Code Modulation) OUTPUT between LPCM 48K and LPCM 96K. The higher the sampling frequency is, the better the output audio quality is. It is recommended to select LPCM 96K.

## PREFERENCES SETUP

### --- PREFERENCES PAGE ---

TV TYPE	AUTO
AUDIO	NTSC
SUBTITLE	PAL
DISC MENU	
PARENTAL	
PASSWORD	
DEFAULTS	
SMART NAV	
MAIN PAGE	

### TV type setup

This player can play discs recorded in either PAL or NTSC format.

Select NTSC format, when the unit is connected to NTSC TV.

Select PAL format, when the unit is connected to PAL TV.

Select AUTO format, the player TV output format will be according to the DVD disc format.

### --- PREFERENCES PAGE ---

TV TYPE	
AUDIO	ENGLISH
SUBTITLE	FRENCH
DISC MENU	SPANISH
PARENTAL	CHINESE
PASSWORD	JAPANESE
DEFAULTS	GERMAN
SMART NAV	ITALIAN
MAIN PAGE	

### AUDIO language setup

Select the preferred AUDIO soundtrack by using the cursor buttons.

# SETUP

--- PREFERENCES PAGE ---

TV TYPE	
AUDIO	ENGLISH
SUBTITLE	FRENCH
DISC MENU	SPANISH
PARENTAL	CHINESE
PASSWORD	JAPANESE
DEFAULTS	GERMAN
SMART NAV	ITALIAN
MAIN PAGE	OFF

## SUBTITLE language setup

Select the preferred SUBTITLE language by using the cursor buttons.

--- PREFERENCES PAGE ---

TV TYPE	1 G
AUDIO	2
SUBTITLE	3 PG
DISC MENU	4 PG 13
PARENTAL	5
PASSWORD	6 PG-R
DEFAULTS	7 NC-17
SMART NAV	8 ADULT
MAIN PAGE	NO_PARENTAL

## PARENTAL

Select suitable parental guidance by the cursor buttons and confirm by pressing OK button.

--- PREFERENCES PAGE ---

TV TYPE	
AUDIO	
SUBTITLE	ENGLISH
DISC MENU	FRENCH
PARENTAL	SPANISH
PASSWORD	CHINESE
DEFAULTS	JAPANESE
SMART NAV	GERMAN
MAIN PAGE	ITALIAN

## DISC MENU language setup

Select the preferred DISC MENU language by using the cursor buttons.

--- PREFERENCES PAGE ---

TV TYPE	
AUDIO	
SUBTITLE	
DISC MENU	
PARENTAL	
PASSWORD	CHANGE
DEFAULTS	
SMART NAV	
MAIN PAGE	

## PASSWORD

Select CHANGE and press OK button. Type the old password (The initial factory code is 3308) and key in 4 characters password now you want to use, and retype again to confirm key in correctly.

# SETUP

--- PREFERENCES PAGE ---

TV TYPE	
AUDIO	
SUBTITLE	
DISC MENU	
PARENTAL	
PASSWORD	
DEFAULTS	RESET
SMART NAV	
MAIN PAGE	

## DEFAULTS

Select RESET to revert to factory initial settings.

--- PREFERENCES PAGE ---

TV TYPE	
AUDIO	
SUBTITLE	
DISC MENU	
PARENTAL	
PASSWORD	
DEFAULTS	NO MENU
SMART NAV	WITH MENU
MAIN PAGE	

## SMART NAV

If select WITH MENU mode, when play a MP3 disc, the smart navigation menu will appear on the screen, then the user can select a track to play according to the menu hint.

If select NO MENU mode, when play a MP3 disc, there is no menu to display and it starts to play directly.

The user can adjust this item according to one's need.

## DEFAULTS TABLE

General Setup	TV Display	Normal/LB
	PIC Mode	AUTO
	Angle Mark	ON
	OSD Language	English
	Captions	ON
	SCR Saver	ON
Speaker Setup	Downmix	Stereo
Audio Setup	Audio Out	SPDIF/RAW
	OP Mode	Line Out
	Dynamic	FULL
	LPCM Output	LPCM 96K
Preferences	TV Type	AUTO
	Audio	English
	Subtitle	English
	DISC Menu	English
	Parental	NO Parental
	Password	3308
	Smart NAV	With Menu

## TROUBLE SHOOTING

---

If it appears that your DVD unit is faulty, first consult this checklist. It may be that something simple has been overlooked.

**Under no circumstances should you try to repair the player yourself, as this will invalidate the warranty. Only qualified service personnel can remove the cover or service this player.**

### **NO POWER**

- Check if the on/off button on the front of the player is set to on.
- Check if AC or DC power plug of the mains unit is properly connected.
- Check if there is power at the AC or DC outlet.

### **NO PICTURE**

- Check if the mode is set to proper state, such as DVD mode and AV mode.
- Check the video connection.

### **DISTORTED PICTURE**

- Check the disc for fingerprints and clean with soft cloth, wiping from centre to edge.
- Sometimes a small amount of picture distortion may appear. This is not a malfunction.

### **COMPLETELY DISTORTED PICTURE**

- The disc format is not according to the TV-set used (PAL/NTSC).

### **NO COLOR IN PICTURE**

- The disc format is not according to the TV-set used (PAL/NTSC).

### **DISC DOES NOT PLAY**

- Ensure the disc label is upwards.
- Clean the disc.
- Check if the disc is defective by trying another disc.

### **NO SOUND**

- Check audio connections.
- If using a HIFI amplifier, try another sound source.

### **DISTORTED SOUND FROM HIFI AMPLIFIER**

- Check to make sure that no audio connections are made to the amplifier phono input.

### **NO RETURN TO START-UP SCREEN WHEN DISC IS REMOVED**

- Press POWER to turn off the unit, then press it again to turn on the unit.
- Press Reset button on the side of the unit.

### **THE PLAYER DOES NOT RESPOND TO THE REMOTE CONTROL**

- Aim the remote control directly at the sensor on the front of the player.
- Avoid all obstacles which may interfere with the signal path.
- Inspect or replace the remote control batteries.

### **DISTORTED OR B/W PICTURE**

- The disc format is not according to the TV-set used (PAL/NTSC).

### **NO AUDIO AT DIGITAL OUTPUT**

- Check the digital connections
- Check the Digital Audio menu to make sure that the digital output is correctly set.
- Check if the audio format of the selected audio language matches your receiver's capabilities.

### **BUTTONS DO NOT WORK**

- Turn the player off and on with the power on/off button on the front of the player.
- Press Reset button on the side of the unit.



# SPECIFICATIONS

---

Supply Voltage	: 12V DC (7V-15V), test voltage 12V, negative ground
Current Consumption	: Less than 2A
Signal System	: Compositive video 1.0Vp-p 75 $\Omega$
Discs Played	: (1) DVD-VIDEO disk 5" (12 cm) single-sided, single-layer 5" (12 cm) single-sided, double-layer (2) Compact disc (CD-DA/CD-R/CD-RW/MP3) (3) 5" (12 cm) Video CD
Audio Output Level	: 10k $\Omega$ (2 ch 1.2 Vrms)
Audio Signal Output Characteristics	: (1) Frequency Response 20 Hz - 20 KHz (2) S/N Ratio 80 dB (JIS) (3) Wow and Flutter Below measurable limits

**Note:**

Specifications and design are subject to modification, without notice, due to improvements in technology.

**This product incorporates copyright protection technology that is protected by method claims of certain U.S. patents and other intellectual property rights owned by Macrovision Corporation and other rights owners. Use of this copyright protection technology must be authorized by Macrovision Corporation, and is intended for home and other limited viewing uses only unless otherwise authorized by Macrovision Corporation. Reverse engineering or disassembly is prohibited.**

## Free Manuals Download Website

<http://myh66.com>

<http://usermanuals.us>

<http://www.somanuals.com>

<http://www.4manuals.cc>

<http://www.manual-lib.com>

<http://www.404manual.com>

<http://www.luxmanual.com>

<http://aubethermostatmanual.com>

Golf course search by state

<http://golfingnear.com>

Email search by domain

<http://emailbydomain.com>

Auto manuals search

<http://auto.somanuals.com>

TV manuals search

<http://tv.somanuals.com>