

# **PYLE**

**MOTORIZED 7" IN -DASH  
LCD COLOR MONITOR  
WITH AM/FM STEREO RADIO**

**MODEL: PLR7N**

**OWNER' S MANUAL**

**Any changes or modifications in construction of this device which is not expressly approved by the party responsible for compliance could void the user's authority to operate the equipment.**



## **WARNING**

---

The exclamation point within an equilateral triangle and “WARNING” are intended to alert the user to the presence of important operating instructions. Failure to heed the instruction will result in severe injury or death.

### **DO NOT WATCH VIDEO WHILE DRIVING**

Watching the video may distract the driver from looking ahead of the vehicle and cause an accident.

### **DO NOT OPERATE ANY FUNCTION THAT TAKES YOUR ATTENTION AWAY FROM SAFELY DRIVING YOUR VEHICLE**

Any function that requires your prolonged attention should only be performed after coming to a complete stop. Always stop the vehicle in a safe location before performing these functions. Failure to do so may result in an accident.

### **DO NOT DISASSEMBLE OR ALTER**

Attempts to disassemble or alter may lead to an accident, fire and / or electric shock.

### **KEEP SMALL ARTICLES OUT OF THE REACH OF CHILDREN**

Store small articles (screws etc.) in places not accessible to children. If swallowed, consult a physician immediately.

### **USE THE CORRECT AMPERE RATING WHEN REPLACING FUSES**

Replace fuses only with fuses of the same ampere rating. Failure to do so may result in a fire and / or damage to the vehicle.

### **HALT USE IMMEDIATELY IF A PROBLEM APPEARS**

When problems appear, stop using the system immediately and contact the dealer from whom you purchased the equipment.



## CAUTION

---

The exclamation point within an equilateral triangle and “CAUTION” are intended to alert the user to the presence of important operating instructions. Failure to heed the instructions can result in injury or material damage.

### **DO NOT RAISE THE VOLUME EXCESSIVELY**

Keep the volume at a level, where you can still hear outside noises while driving .  
Driving while unable to hear outside could cause an accident.

### **DO NOT USE THIS EQUIPMENT OUTSIDE THE VEHICLE**

Do not use this equipment for purposes other than those listed for a vehicle.  
Failure to do so may result in an electric shock or an injury.

### **KEEP FOREIGN OBJECTS OUT OF THE MONITOR COMPARTMENT**

Keep foreign objects out of the monitor compartment.  
Also, avoid placing your hands in the area where it might interfere with the monitor's operation.

### **STOP THE VEHICLE BEFORE CARRYING OUT ANY OPERATION THAT COULD INTERFERES WITH YOUR DRIVING.**

If the operation of this unit (such as raising or lowering of the monitor, etc.) interferes with you driving, stop the vehicle in a safe location before attempting operation.

### **DO NOT MIX NEW BATTERIES WITH OLD BATTERIES. INSERT WITH THE CORRECT BATTERY POLARITY**

Do not mix new batteries with old batteries and do not replace with other than specified batteries. When inserting the batteries, be sure to observe proper polarity (+ and - ) as instructed. Battery rupture or chemical leakage can cause an injury or equipment malfunction.



## CAUTION

---

The exclamation point within an equilateral triangle and “CAUTION” are intended to alert the user to the presence of important operating instructions. Failure to heed the instructions can result in injury or material damage.

Operation of some of the functions of this unit is very complex. Because of this, it was deemed necessary to place these functions into a special SETUP screen. This will restrict operation of these functions to times when the vehicle is parked. This ensures the focus of the driver’s attention will be on the road and not on the unit. This has been done for the safety of the driver and passengers.

### TEMPERATURE

Be sure the temperature inside the vehicle is between +60° C (+140° F) and -5° C (+23° F) before turning your unit on.

### FUSE REPLACEMENT

When replacing the fuses, the replacement must be the same amperage as shown on the fuse holder. If the fuse(s) blow more than once, carefully check all electrical connections for shorted circuitry. Also have your vehicle’s voltage regulator checked.

### MAINTENANCE

If you have problems, do not attempt to repair the unit yourself. Return it to your purchasing dealer.

### INSTALLATION LOCATION

Make sure the unit will not be exposed to :

- ▶ Direct sun & heat
- ▶ High humidity
- ▶ Excessive dust
- ▶ Excessive vibrations



# REMOTE CONTROLLER

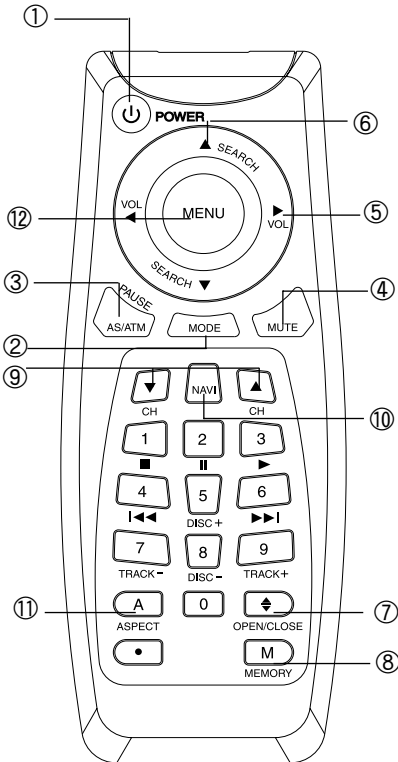

- ① POWER ON/OFF BUTTON
- ② MODE SELECTION BUTTON
- ③ AS/ATM BUTTON
- ④ SOUND MUTE BUTTON
- ⑤ VOLUME UP/DOWN BUTTON
- ⑥ SEARCH UP/DOWN BUTTON
- ⑦ OPEN/CLOSE BUTTON
- ⑧ MANUAL MEMORY BUTTON
- ⑨ CHANNEL UP/DOWN BUTTON
- ⑩ NAVIGATION BUTTON
- ⑪ ASPECT BUTTON
- ⑫ MENU SELECTION BUTTON

## REMOTE CONTROL UNIT

### Replacing battery

Applicable battery : Use two “AAA” sized dry batteries.

#### 1. Opening the battery cover.

Push and slide the cover in the arrow direction, and the cover will be removed.

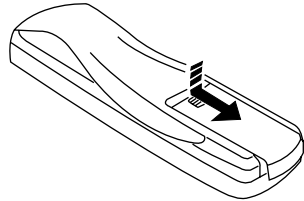

#### 2. Replacing the battery.

Remove the old batteries.  
Insert new ones matching the (+) and (-) polarities as shown in the diagram inside the unit.

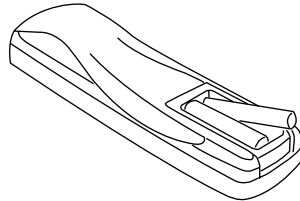

#### 3. Closing the cover.

Push the cover in the arrow direction until a click is heard.

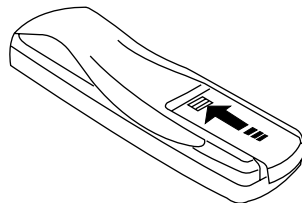



# BASIC OPERATION

## POWER ON / OFF

### RADIO MAIN MENU

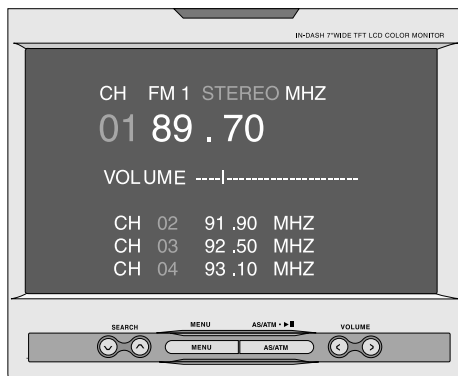

#### 1. POWER ON

- 1) Press the POWER button to turn the power on. But the monitor will not open.
- 2) You can also turn the power on by pressing the OPEN/CLOSE button. The power will be on and the monitor will open.

#### 2. POWER OFF

- 1) Press the POWER button again to turn the power off.
- 2) If you turn the power off by pressing the POWER button when the monitor opens, the monitor will not close.  
If the car key is pulled out, or the OPEN/CLOSE button is pressed the monitor will automatically close.

## OPENING THE MONITOR

Press OPEN/CLOSE button. The monitor will open.

### NOTE

If the OPEN/CLOSE button is pressed when the monitor is closed and the power is off, the monitor will open and the power will turn on.

## CLOSING THE MONITOR

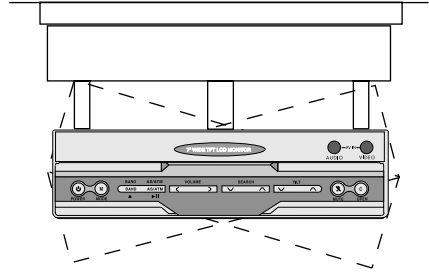
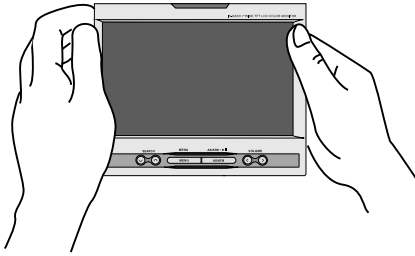

1. Hold left and right upper side of the monitor and set the left and right angle of the monitor parallel with the front of the unit as the picture.
2. Press OPEN/CLOSE button. The monitor will close.

### NOTE

1. If the left and right angle of the monitor is not parallel to the front of the unit, the monitor can not be closed.
2. If the OPEN/CLOSE button is pressed while radio or video is on, the monitor will close. But the sound is still on. Press the POWER button to turn the sound off.

## ADJUSTING THE TILT POSITION

1. Press the MENU button repeatedly on radio or AV mode until the USER SELECTOR menu is selected.
2. Press the SEARCH UP/DOWN button to select TILT POSITION.
3. Press the VOLUME ► or ◀ button. Each time you press the VOLUME ► or ◀ button, the monitor will slant forward or backward one step. The tilt position can be adjusted in 5 steps. For more information, see page 21 of owner' s manual.

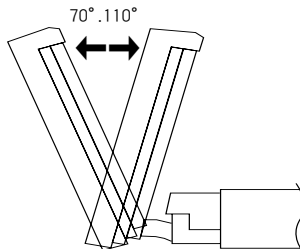

### NOTE

You can also adjust the TILT position by pushing the TILT UP/DOWN button on the unit. Each time you press the TILT UP/DOWN button, the monitor slants backward or forward one step. The tilt position can be adjusted in 5 steps.

## ADJUSTING THE SLIDE POSITION

1. Press the MENU button repeatedly on radio or AV mode until the USER SELECTOR menu is selected.
2. Press the SEARCH UP/DOWN button to select MOVE
3. Press the VOLUME ► button to select FORWARD. The monitor will slide one step (15mm) to the front.
4. Press the VOLUME ◀ button to select BACKWARD. The monitor will slide one step (15mm) to the back.

For more information, see page 21 of owner' s manual.

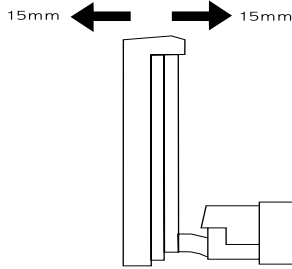

### NOTE

1. If the VOLUME ► button is pressed when FORWARD is selected, the monitor will not slide to the front.
2. If the VOLUME ◀ button is pressed when BACKWARD is selected, the monitor will not slide to the back.

## ADJUSTING THE LEFT/RIGHT VIEWING POSITION

The monitor' s left/right position can be adjusted for easier viewing by hand-operating.

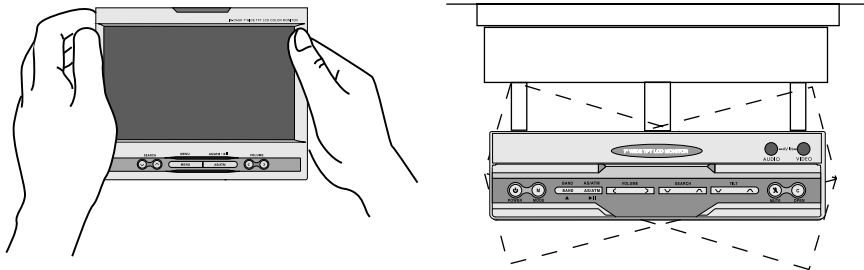

## SELECTING MODE

Press the MODE button to select the desired mode. Each time you press the button, the mode changes as follows.

RADIO -> AV1 -> AV2 -> AV3 (CD OR VCD CHANGER) -> AV4 (TV)



### NOTE

1. AV3 has only video input.
2. The CD/VCD changer must be connected to the 8 pin DIN socket on the rear of the unit with 8 pin DIN cable in our CD/VCD changer gift box.
3. The video output of VCD changer must be connected to AV3 video input.  
If the video output of VCD changer is not connected AV3 video input, AV3 video input can be used for video input of other video sources.

## ADJUSTING VOLUME

Press the VOLUME ◀ or ▶ button to adjust the volume level.

## AUDIO MUTE

Press the MUTE button to make the sound quite. Press the MUTE button again to return to the previous audio level.

## RESET

1. If the unit does not seem to be working right, press the RESET switch with a pencil or other pointed object. The RESET switch is mounted behind the small hole on the upper right of the front face, to the left of the AUDIO INPUT hole.
2. If the RESET switch is pressed, the power will be off, press the POWER button to turn power on.
3. If reset does not solve the problem, consult your installer.

## ADJUSTING THE TV/VIDEO PICTURE MODE (ASPECT)

Each time you press A (ASPECT) button, the picture mode switches between Normal, Full, Zoom and Wide.

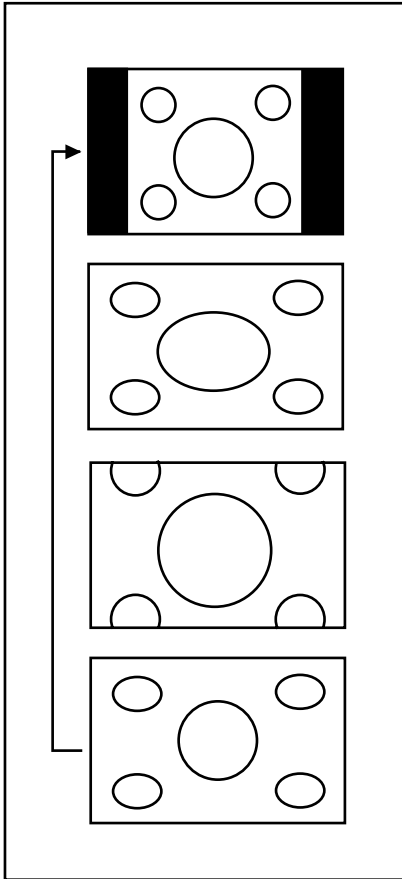

### **NORMAL MODE**

The monitor displays normal picture at the center of the screen with the proportion of 4 to 3. The screen shows a vertical black belt at each side.

### **FULL MODE**

The monitor displays normal picture wider by stretching out horizontally with the proportion of 16 to 9.

### **ZOOM MODE**

The monitor displays normal picture wider by stretching out horizontally and vertically with the proportion of 4 to 3. The screen doesn't show upper and down part of the picture slightly.

### **WIDE MODE**

The monitor displays normal picture wider by unevenly stretching out horizontally with the proportion of 16 to 9. The stretching proportion is bigger toward each side of the picture.

### **NOTE**

You can also select the picture mode manually by pressing the function button on the unit as follows.

1. Press the MODE button to select radio mode.
2. Press the MENU button repeatedly until RADIO SUB MENU is selected.
3. Press the SEARCH UP/DOWN button to select SCREEN.
4. Press the VOLUME ◀ or ▶ button to select the desired picture mode.

# RADIO CONTROL

Press the OPEN/CLOSE button to turn the power on and to open the monitor. The monitor shows following picture.

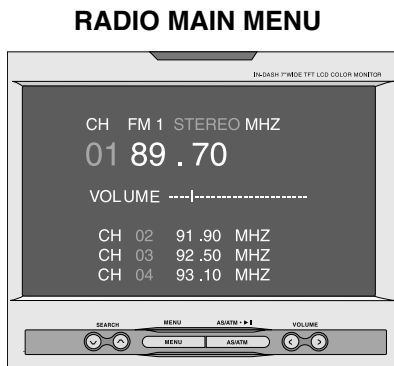

## NOTE

1. Each time you press the MENU button on RADIO MAIN MENU screen, the menu on the screen changes as follows.

RADIO SUB -> VOLUME -> USER SELECTOR -> PICTURE -> RADIO MAIN



2. You can select the items on each menu by pressing the SEARCH UP/DOWN button.
3. You can adjust the level of the selected items by pressing the VOLUME or CH UP /DOWN button.

## MANUAL TUNING

Press the CH UP/DOWN button to move downward or upward one step respectively until the desired station frequency is selected.

## MANUAL STORING OF STATION

1. Tune in the desired radio station you wish to store on the CH number.
2. Press the M(MEMORY) button to store the desired radio station.  
The station will be stored into the next CH number of the last CH number previously stored station.
3. They can be stored up to 30 radio stations in each band.  
FM1:30, FM2: 30, AM1:30, AM2:30 stations (total 120 stations).

## AUTO MEMORY OF STATION

1. Tune in desired radio station you wish to store on the CH number.
2. Press the AS/ATM button for at least 2 seconds. The frequency on the display continues to change while the auto memory is in progress.  
The tuner will automatically seek and can store up to 30 stations in each band in order of frequency signal. They can be stored in FM1: 30, FM2: 30, AM1: 30 and AM2: 30 stations (total 120 stations).
3. When the auto memory has been completed, the tuner goes to the station stored in the CH No.1.

### NOTE

On CD changer mode, you can pause or playback the current CD by pressing the AS/ATM button.

## TUNING TO THE STORED STATION

Press the SEARCH UP/DOWN button repeatedly until the desired station is selected.

## SELECTING THE BAND AREA FOR YOUR COUNTRY

1. Press the MENU button on radio mode. The monitor shows following picture.

### RADIO SUB MENU

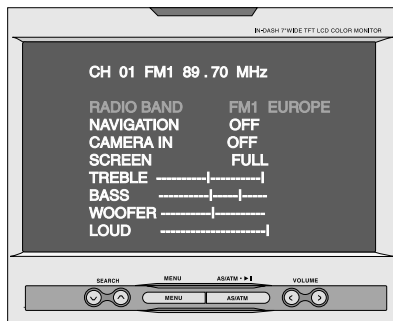

2. Press the SEARCH UP/DOWN button to select RADIO BAND.
3. When RADIO BAND is selected, press CH UP/DOWN button to select the radio band area (EUROPE or USA) for your country. Each time you press the CH UP/DOWN button, the band switches as EUROPE --> USA

## RADIO BAND

1. Press the SEARCH UP/DOWN button to select RADIO BAND.
2. When RADIO BAND is selected, press the VOLUME ◀ or ▶ button to select the band. Each time you press the VOLUME ◀ or ▶ button, the band switches as follows.

FM1 -> FM2 -> AM1 -> AM2



3. You can also select the band by pushing the BAND button on the unit. Each time you press the BAND button, the band switches as follows.

FM1 -> FM2 -> AM1 -> AM2



## TREBLE

1. Press the SEARCH UP/DOWN button to select TREBLE.
2. Press the VOLUME ◀ or ▶ button to adjust treble level.

## BASS

1. Press the SEARCH UP/DOWN button to select BASS.
2. Press the VOLUME ◀ or ▶ button to adjust bass level.

## SUB WOOFER

1. Press the SEARCH UP/DOWN button to select SUB WOOFER.
2. Press the VOLUME ◀ or ▶ button to adjust sub woofer level.

## LOUDNESS

1. Press the SEARCH UP/DOWN button to select LOUD.
2. Press the VOLUME ◀ or ▶ button to adjust loudness level.



## SETTING THE NAVIGATION

1. Connect a NAVIGATION system only to AV1 or AV2 Input terminals on the rear of the unit.
2. Press the MODE button to select radio mode.
3. Press the MENU button to select following picture.

### RADIO SUB MENU



4. Press the SEARCH UP/DOWN button to select NAVIGATION.
5. Press the VOLUME ◀ or ▶ button to select AV1 or AV2 that NAVIGATION system is connected to.

Each time you press this button, AV Input changes as follows

AV 1 -> AV2 -> OFF



## WATCHING THE NAVIGATION PICTURE

Press the NAVI button on radio, AV1, 2 or 3 mode. The monitor shows the navigation picture.

### NOTE

Do not select the AV mode connected to the NAVIGATION system with the MODE button. If AV Input connected to the NAVIGATION system is selected with the MODE button, the monitor does not show the NAVIGATION picture. The monitor shows the WARNING picture.

## SETTING THE CAMERA IN

1. Connect a Back View Camera video output only to AV1,2 or 3 video Input terminals on the rear of the unit.
  - \* When the VCD changer is connected to AV3 Video input, The back view camera can be connected only to AV1 or AV2 video input.
2. Press the MODE button to select radio mode.
3. Press the MENU button to select following picture.

### RADIO SUB MENU



4. Press the SEARCH UP/DOWN button to select CAMERA IN.
5. Press the VOLUME ◀ or ▶ button to select AV1,2 or 3 mode that Back View Camera is connected. Each time you press this button, AV Input changes as AV1 -> AV2 -> AV3 -> OFF

↑

## WATCHING THE BACK VIEW PICTURE

Set the rear gear on any mode. The monitor shows the back view camera picture.

## WIRING CONNECTION

Connect orange color connection wire named “REVERSE GEAR” to a switched power output terminal of the R (reverse) gear.

See page 26: BASIC CONNECTIONS.

### NOTE

If AV input connected to the Back view Camera is selected with the MODE button, the monitor does not show the back view camera picture. The Monitor shows only the WARNING picture.

# CD CHANGER CONTROL

When a CD (VCD) changer is connected to this unit with 8 pin DIN cable, AV3 mode changes to CDC mode and CDC control menu is displayed on the screen.

1. Press the MODE button to select CD CHANGER (AV3) mode.  
Each time you press this button, the display changes as follows.  
RADIO-> AV1-> AV2-> AV3 (CD or VCD CHANGER) -> AV4(TV)

2. When CD CHANGER (AV3) mode is selected, The monitor shows following picture.



3. Press the SEARCH UP/DOWN button to select the item.
4. Press the CH UP/DOWN button to adjust the level of the selected item. You can also adjust the level upward by pushing the BAND button on the unit.

## NOTE

1. Each time the MENU button is pressed on CDC mode, the menu on the screen changes as follows.

CD CHANGER -> VOLUME -> USER SELECTOR -> PICTURE -> OSD OFF

2. The CD (VCD) changer must be connected to the 8pin DIN socket on the rear of the unit with the 8pin DIN cable in our CD/VCD changer gift box.
3. The video output of VCD changer must be connected to AV3 video input.

## CD STATUS

This shows the current CD status (DISK CHECK, SEEK, PLAY, ETC)

## PLAY TIME

This shows playing time of the disc being played.

## DISK NUMBER

1. Press the SEARCH UP/DOWN button to select DISK NUMBER.
2. Each time you press the CH UP button, the disc in the CD changer will be selected forward and the displayed disc number increases by one.
3. Each time you press the CH DOWN button, the disc in the CD changer will be selected backward and the displayed disc number decreases by one.

## TRACK NUMBER

1. Press the SEARCH UP/DOWN button to select TRACK NUMBER.
2. Each time you press the CH UP button, the next track number will be selected forward and the displayed track number increases by one.
3. Each time you press the CH DOWN button, the previous track number will be selected and the displayed track number decreases by one.

## INTRO SCAN

1. Press the SEARCH button to select INTRO SCAN.
2. Press the CH UP/DOWN button to select the item.  
Each time you press the CH UP/DOWN button or the BAND button, the item changes as ONE -> ALL -> OFF



- ALL** : The first 10 seconds of first track of all the discs will be played in succession.  
**ONE** : The first 10 seconds of each track of the selected disc will be played in succession.  
**OFF** : INTRO SCAN will be off.

## REPEAT

1. Press the SEARCH button to select REPEAT.
2. Press the CH UP/DOWN button or the band button to select the item. Each time you press the CH button, the item changes as ONE -> ALL -> OFF



- ALL** : All the tracks on the current disc will be played repeatedly.  
**ONE** : The selected track on the current disc will be played repeatedly.  
**OFF** : REPEAT will be off.

## RANDOM

1. Press the SEARCH UP/DOWN button to select RANDOM .
2. Press the CH UP/DOWN button or the BAND button to select the item.  
Each time you press the button, the item changes as ONE -> ALL -> OFF



- ALL** : The tracks on all the discs in the CD/VCD changer will be played in random order.  
**ONE** : All the tracks on the current disc will be played in random order.  
**OFF** : RANDOM will be off.

## PAUSE

Press the AS/ATM button to pause playback. Press the button again to resume playback.

## DIRECT CD CHANGER CONTROL

On the CD changer mode, you can directly control CD changer functions just by pressing the buttons on the remote controller for our monitor unit.

- STOP ■** button : to make the playing of the disc stop.
- PAUSE ||** button : to stop the playing of the disc .  
press again to play again.
- PLAY ►** button : to make the disc play.
- REW |◀◀** button : to quickly move backward of the disc until you reach the desired section of the track.
- FF ►►|** button : to quickly move forward of the disc until you reach the desired section of the track.
- DISC +** button : to search forwards through the discs in a CD changer until you reach the desired disc.
- DISC -** button : to search backwards through the discs in a CD changer until you reach the desired disc.
- TRACK +** button : to search forwards through the tracks on the disc until you reach the desired track.
- TRACK -** button : to search backwards through the tracks on the disc until you reach the desired track.

### NOTE

1. The AS/ATM button on the remote controller can be used as the PAUSE button.
2. When the CD changer mode is selected again after switching the CD changer mode to other modes or the power of the monitor unit is tuned on again after tuned it off, the disc plays at the last played position.
3. When the ignition is switched on again after the car key is pulled out on CD changer mode, the disc plays at the beginning of the track last played.

## VOLUME ADJUSTMENT OF EACH CHANNEL

You can adjust the volume level of each channel of the radio or AV sources connected to this unit.

### ADJUSTING THE VOLUME OF EACH CHANNEL

1. Press the MENU button repeatedly on radio or AV mode until VOLUME MENU is selected  
The monitor shows following picture.



2. Press the SEARCH UP/DOWN button to select the audio channel that you want to adjust.
3. Press the VOLUME ◀ or ▶ button to adjust the volume level of the selected audio channel.

### DEFAULT

1. Press the SEARCH UP/DOWN button to select DEFAULT.
2. Press the VOLUME ◀ or ▶ button to select ON or OFF.  
Each time you press the VOLUME ◀ or ▶ button, the display changes as follows.  
ON -> OFF  
↑

## FINE ADJUSTMENT FOR CENTER FREQUENCY AND TILT/SLIDE POSITION

1. Press the MENU button when the monitor shows following picture.

### VOLUME MENU

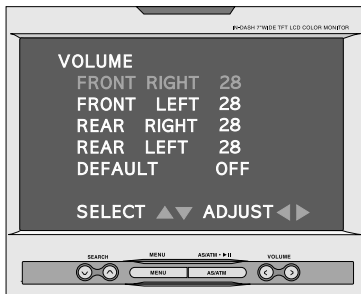

The monitor shows following picture.

### USER SELECTOR MENU

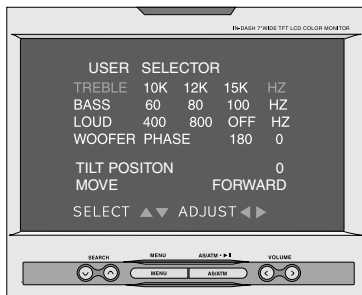

2. Press the SEARCH UP/DOWN button to select the items that you want to adjust.
3. Press the VOLUME ◀ or ▶ button to adjust the level of the selected item.

1. Press the MENU button when the monitor shows following picture.

## USER SELECTOR MENU

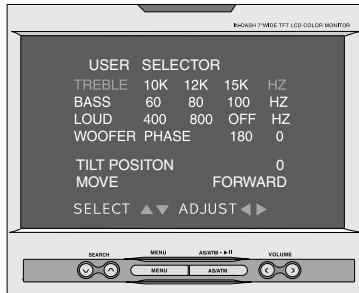

The monitor shows following picture.

## PICTURE MENU

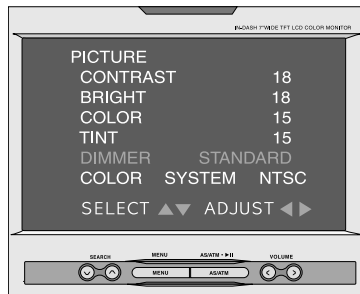

2. Press the SEARCH UP/DOWN button to select the items that you want to adjust.
3. Press the VOLUME ◀ or ▶ button to adjust the level of the selected item.



## SELECTING COLOR/SOUND SYSTEM

1. Press the SEARCH UP/DOWN button to select COLOR SYSTEM for the video source on PICTURE menu.

### PICTURE MENU

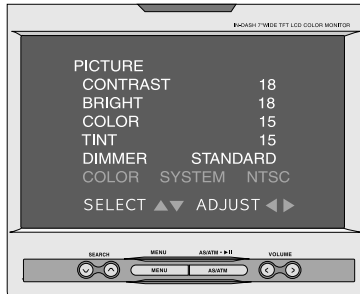

2. Press the VOLUME ◀ or ▶ button to select PAL or NTSC for the video source.

### NOTE

To select the color system for the TV when the TV tuner box is connected to the AV4 input of this unit,

1. Select color system (PAL or NTSC) for the video source at COLOR SYSTEM on PICTURE menu on radio mode first.
2. Select color and sound system again at COLOR SYSTEM on FUNCTION menu on TV mode. For more information, see page 5 & 6 "COLOR & SOUND SYSTEM" in owner's manual for the TV tuner.

### NOTE

If the monitor displays the picture in black & white color, select the color system again for the video source.

## VOLUME CONTROL ON AV MODE

To adjust audio level of AV sources on AV mode,

1. Press the VOLUME ◀ or ▶ button.

The monitor shows following picture.

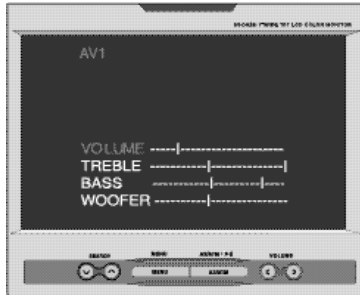

2. Press the SEARCH UP/DOWN button to select the items that you want to adjust.
3. Press the VOLUME ◀ or ▶ button to adjust the audio level of the selected item.

### NOTE

1. Each time the MENU button is pressed on AV1, 2 or 3 mode, the menu is selected as follows.  
VOLUME -> USER SELECTOR -> PICTURE  
↑
2. You can select the items on each menu by pressing the SEARCH UP/DOWN button.
3. You can adjust the level of the selected items by pressing the VOLUME ◀ or ▶ button.

## WARNING SCREEN

The monitor shows following warning picture when the parking brake is not set or when driving to prevent traffic accident that may be caused while watching the screen. The monitor shows the warning picture only and does not show any other pictures, but you can enjoy the sound only by adjusting the volume.



## AV INPUT FACE PLATE OF THE UNIT

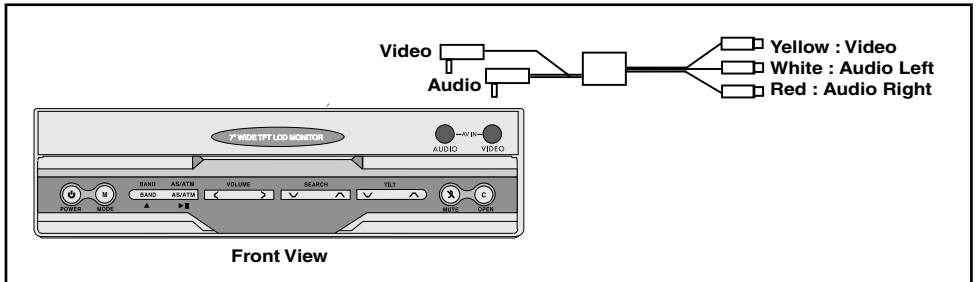

### NOTE

3.5  $\emptyset$  AV input on the front face of the unit is same input with AV1 input on the rear of the unit. If the sources are connected both input terminals, the 3.5  $\emptyset$  input has priority in working.

## PRECAUTIONS

Choose the mounting location carefully so that the unit will not interfere with the normal driving functions of the driver.

Avoid installing the unit where it would be subject to high temperatures, such as from direct sunlight or hot air from the heater, or where it would be subject to dust, dirt or excessive vibration.

Use only the supplied mounting hardware for a safe and secure installation.

Be sure to remove the front panel before installing the unit.

## Mounting angle adjustment

Adjust the mounting angle to less than 20°.

## MOUNTING EXAMPLE

Installation in the dashboard

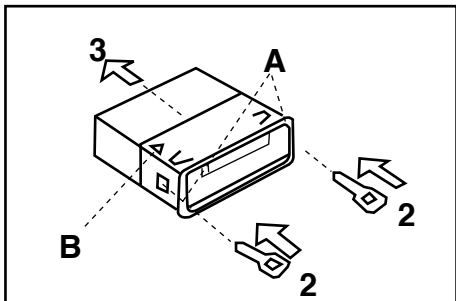
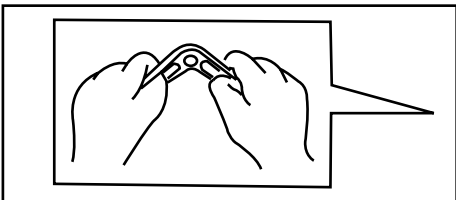
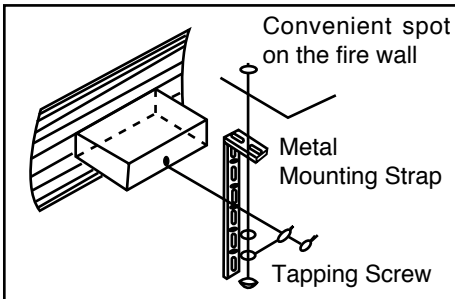

## Strap

Be sure to use the strap to secure the back of the unit in place to prevent sound cuts or skips.

The strap can be bent by hand to the desired angle.

## Holder

After inserting the holder into the dashboard, select the appropriate tabs according to the thickness of the dashboard material and bend them inwards to secure the holder in place.

## How to Detach the Mounting Frame

1. Insert release keys into the slots A.
2. Remove the frame B from the unit. Keep the release key in the safe place as you may need it in the future to remove the unit from the car.

NOTE : Keep the release keys in the safe place as you may need it in the future to move the unit from the car.

# BASIC CONNECTIONS

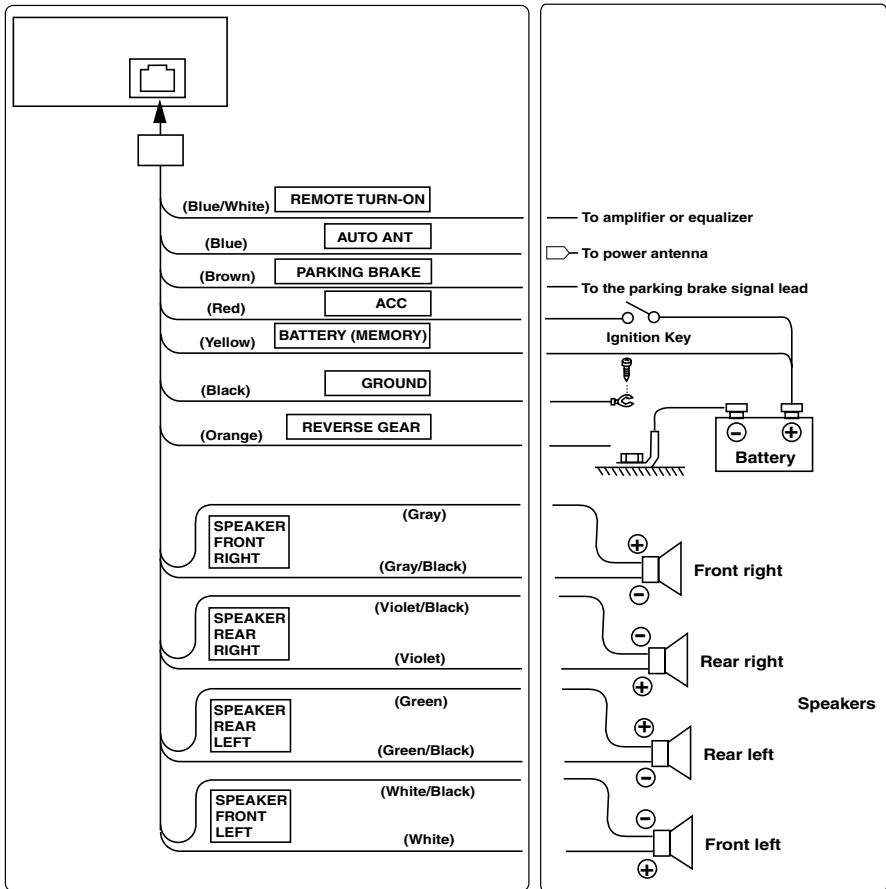

## NOTE

1. Be sure that the PARKING SENSOR WIRE must be grounded or opened. If it is connected to ACC (B+). The unit can be damaged.
2. Do not ground the POWER ANTENNA or REMOTE TURN ON wire. If it is grounded, the unit can be damaged.

# CONNECTING TO CD CHANGER AND TV TUNER BOX

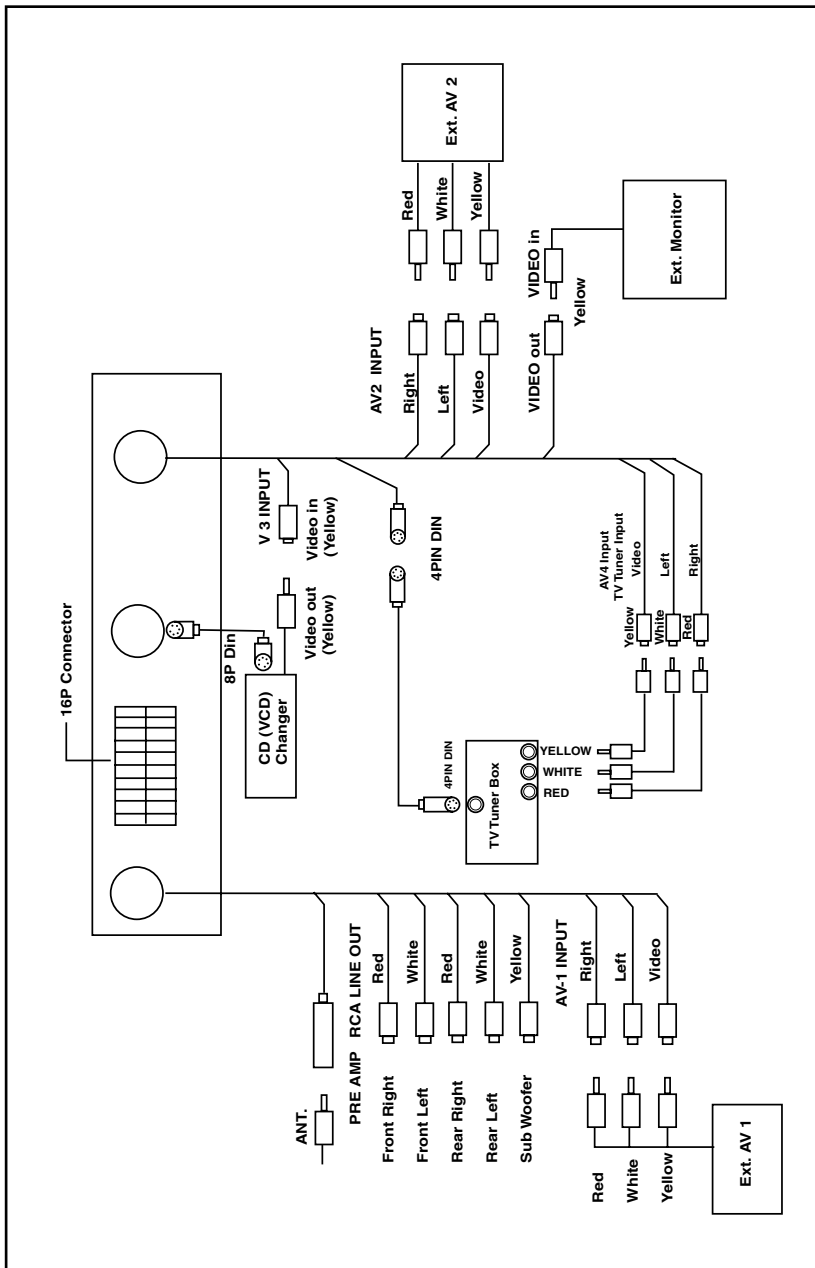

## AM SECTION

USA BAND Frequency Range	530-1710KHz
Frequency Step	10KHz
EUROPE BAND Frequency Range	522-1620KHz
Frequency Step	9KHz
Intermediate Frequency	450 KHz
Usable Sensitivity	32 dB
Image Rejection Ratio	45dB
IF Rejection Ratio	100dB

## FM SECTION

Frequency Range	87.5~108 MHz
Frequency Step Manual tuning	50 KHz
Seek tuning	100KHz
Intermediate Frequency	10.7MHz
Usable Sensitivity	12dB
Image Rejection Ratio	45dB
IF Rejection Ratio	60dB

## CD CHANGER

Signal/Noise Ratio	>80dB
Frequency Response	20kHz - 20kHz
Channel Separation	>60dB
D/A Converter	16Bit/CH

## AMPLIFIER

Total Max Power	200 Watts peak
Power Output	50W X 4

## GENERAL

Power Supply	DC 14.4V (11V - 15V)
Polarity	Negative Ground only
Speaker Impedance	4~8 Ω
Fuses	Fast blow (1A and 10A)
Dimensions	178(W)x 50(H)x 155(D)mm
Weight	Net
	Gross
	2.5Kg
	3.5Kg



## **WARNING**

**DO NOT HOLD THE LCD SCREEN PANEL WHILE IT IS OPENING OR CLOSING UNTIL IT IS COMPLETELY OPENED OR CLOSED. OTHERWISE, THE MOTORIZED MECHANISM WILL BE DAMAGED.**

**BEFORE WORKING THE UNIT, READ THE OWNER'S MANUAL CAREFULLY AND FOLLOW UP THE INSTRUCTIONS IN IT. ALWAYS WORK THE UNIT WITH THE REMOTE CONTROLLER OR THE FUNCTION BUTTONS ON THE UNIT. OTHERWISE, THE UNIT CAN BE DAMAGED.**

## Free Manuals Download Website

<http://myh66.com>

<http://usermanuals.us>

<http://www.somanuals.com>

<http://www.4manuals.cc>

<http://www.manual-lib.com>

<http://www.404manual.com>

<http://www.luxmanual.com>

<http://aubethermostatmanual.com>

Golf course search by state

<http://golfingnear.com>

Email search by domain

<http://emailbydomain.com>

Auto manuals search

<http://auto.somanuals.com>

TV manuals search

<http://tv.somanuals.com>