

PYLE® view

10.4" ROOF MOUNT TFT-LCD COLOR MONITOR
W/BUILT-IN DVD PLAYER

Instruction Manual



WARNING:

DO NOT WATCH MONITOR
WHILE VEHICLE IN MOTION, THIS
MAY RESULT IN SERIOUS INJURY OR DEATH.

PLRD103F

[HTTP://WWW.PYLEAUDIO.COM](http://www.pyleaudio.com)

封二空白

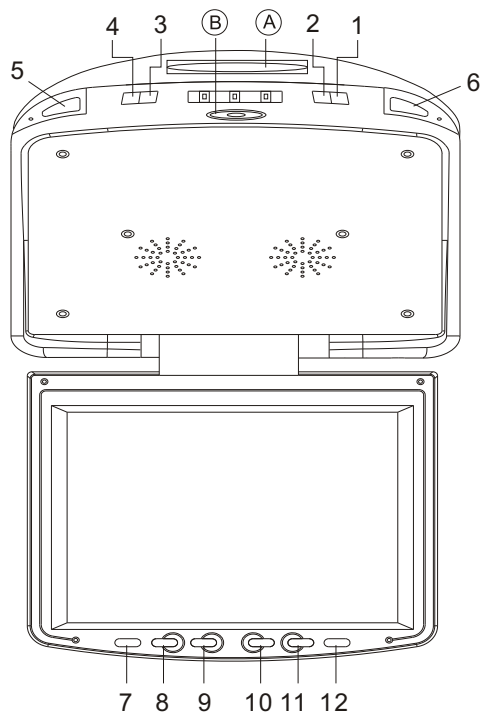

PANEL

- Ⓐ .DVD loader
- Ⓑ .Eject latch.
- 1. Open/Close
- 2. Play/Pause
- 3. Next
- 4. Previous
- 5.6. Dome Light and IR
- 7. Power indicator light
- 8. Power on/off
- 9. Adjustment(-)
- 10. Menu
- 11. Adjustment(+)
- 12. Remote control window

INSTALLATION DIAGRAM FOR FLIP DOWN SYSTEM

Step1:use mounting bracket (A) to cut out the size of ceiling to provide a mounting surface for the housing of the monitor to be attached to.

step2:use tapping screws or rivets on position (B) for mounting bracket (A) on the vehicles ceiling.

step3: use the 4 machine screws(C) to mount the housing of the monitor to mounting bracket (A)

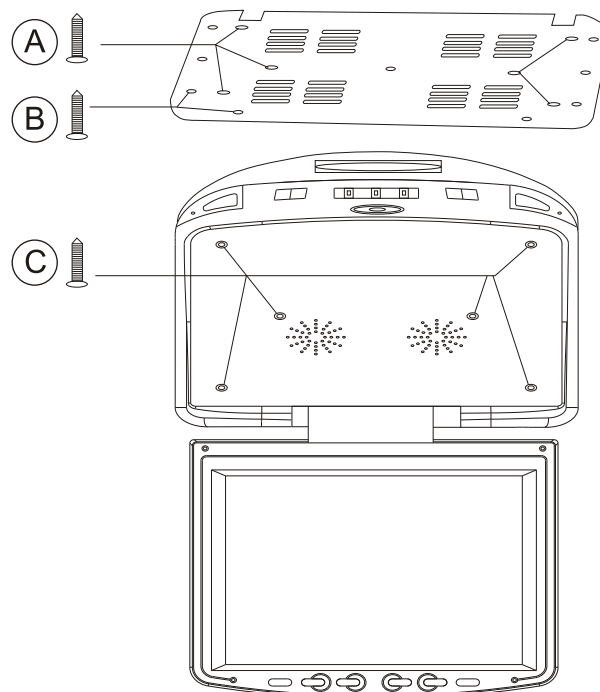

Place for setting plate

Affix the setting plate to the place shown above by screws, Then assembly the monitor to the setting plate.

Monitor function

Enter into MENU, Use +/- buttons to adjust the picture's BRIGHT, CONTRAST,COLOR,TINT and RESET.

DVD player

Load DVD: Insert DVD into player, The screen will display READING, Pls wait around 8second, DVD will loaded and start play DVD disc.

Pause/Resume: To pause DVD play, press ►|| button, To resume DVD play, press ►|| button again.

Fast Forward / Backward: Press ◀◀ / ▶▶ to fast forward and backward when playing DVD.

Press ◀◀ / ▶▶ to choose previous or next song by remote control.

Turn to appointed menu or time
press SEARCH key, will show following picture:

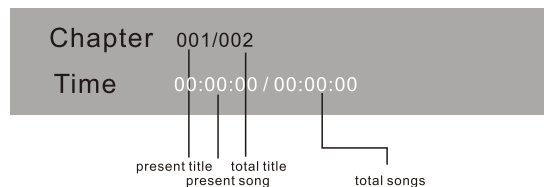

Press → on the remote control to present song ,then input the number of the song or the time you want closed by ENTER. If the number is 10 above, press 10 and then the number.

DVD Info:

Turn to DVD title by press TITLE on the remote control.

DVD Setting:

a) Video and audio setting

press SETUP to preset DVD of the video or audio. Attached is the main menu and sub menu.

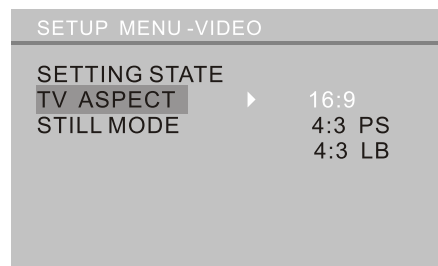
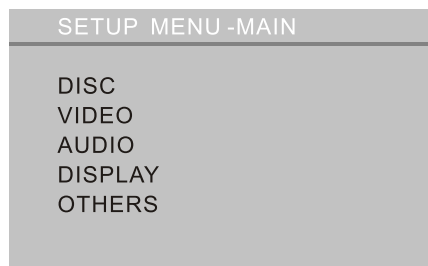

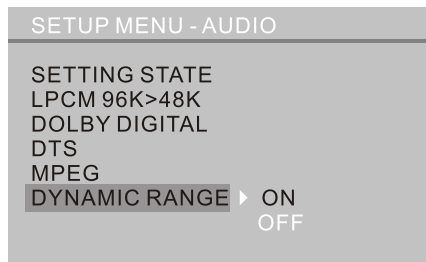
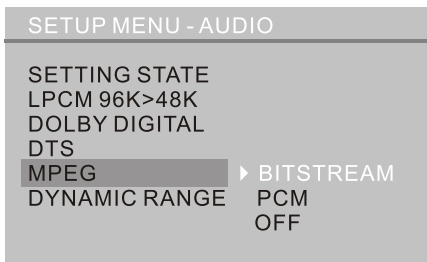
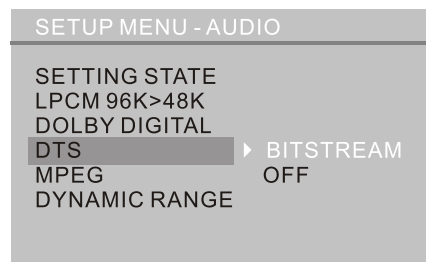
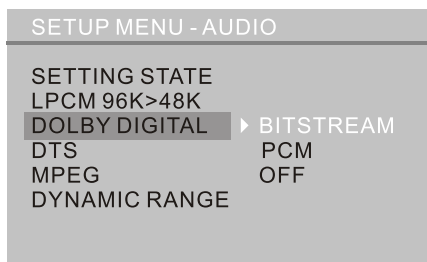
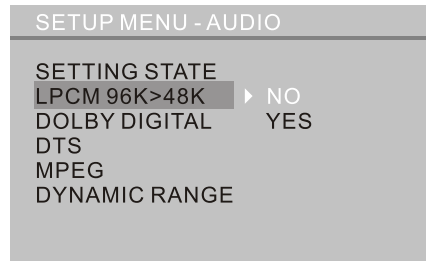
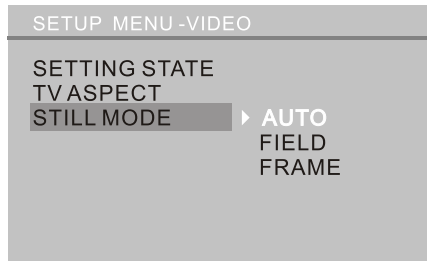

b) Language and others setting

press SETUP to setup the language or others info, attached is the main menu and sub menu:

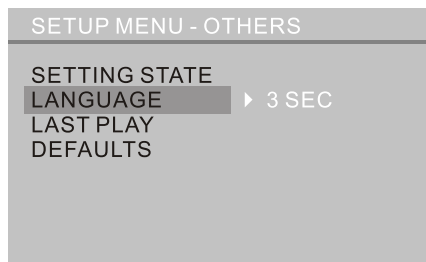
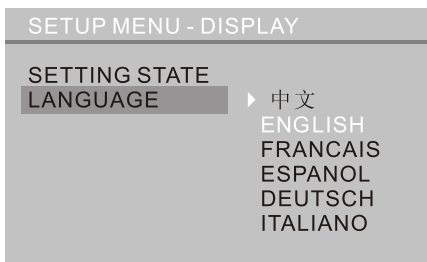

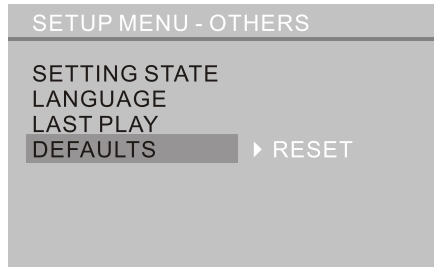
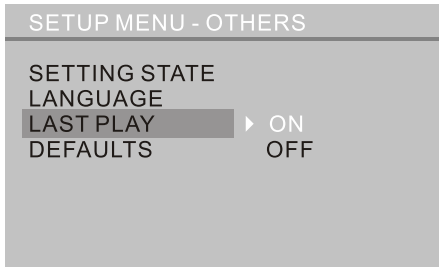

c)DISC setting

press SETUP to setup the disc info, attached is the main menu and sub menu:

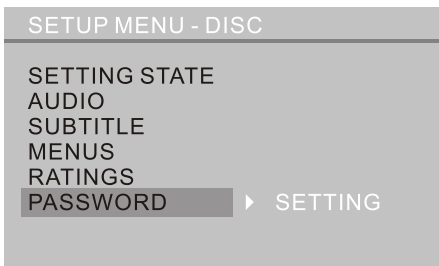
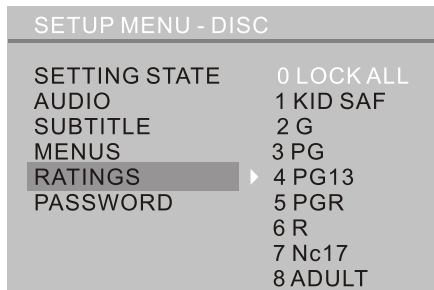
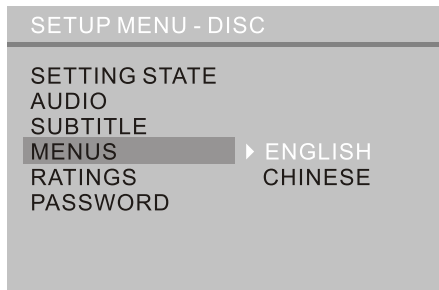
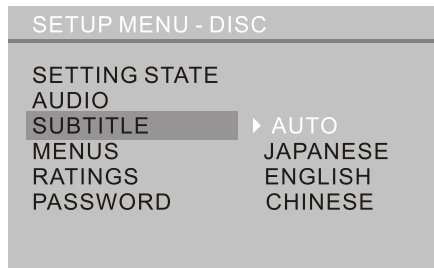
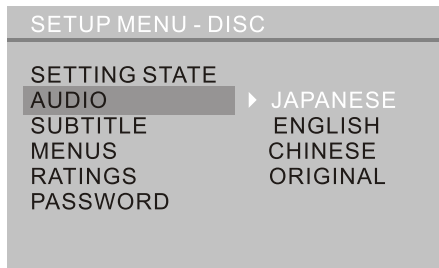

NOTICE:

- 1 .Use ◀ ▶ ▲ ▼ to select the items.Press ENTER to confirm the setting.
2. Do not change preset if unnecessary.
3. In USA always selection NTSC.
4. Original password:0000
5. Part of the functions are available only under certain conditions,
while some are not available right now.
- 6.This unit has position memory.

REMOTE CONTROL

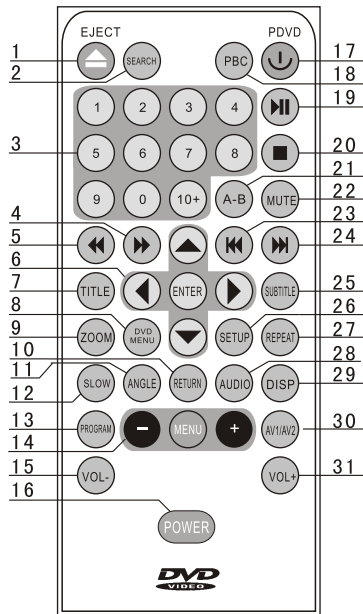

1. ▲ Enter/eject the disc
2. SEARCH: locates the title/chapter/time and play.
3. 1~ 10: input numbers.
4. Fast forward.
5. Fast backward.
6. ◀ ▶ ▲ ▼ : direction key, ENTER: enter.
7. TITLE: display the DVD title.
8. DVD-MENU: display the DVD menu screen.
9. ZOOM: zoom in or zoom out picture on the screen.
10. RETURN: return to previous item.
11. ANGLE: change picture angle.
12. SLOW: press the button to slow play to 1/2, 1/4, 1/8, 1/16, 1/32 speed.
13. PROGRAM: edit.
14. Picture adjustment menu.
15. VOL-: Volume lower.
16. POWER: power of this monitor.
17. PDVD: DVD power.
18. PBC: playback control.

19. ▶▶ : play or stop temporarily.
20. ■ : stop playing of picture or audio.
21. A-B: press the button during play to set point A and point B, then the program between point A and B will be played repeatedly. Press again to cancel.
22. MUTE: press the button during play to stop audio. Press the button again to resume.
23. ◀◀: Prev track or chapter.
24. ▶▶: Next track or chapter.
25. Subtitle: change the DVD's subtitle languages.
26. SETUP: enter or cancel the setup menu.
27. REPEAT: for DVD: play title or chapter repeatedly. for CD: play tracks or the entire disc repeatedly.
28. AUDIO: mode of audio.
29. DISP: display disc information.
30. AV1/AV2: DVD and external video selection.
31. VOL+: Volume louder.

BASIC TROUBLE SHOOTING

Symptom:	Cause:	Correction:
No Power	Open Fuse	Old fuses sometimes fail from fatigue, however, most failures indicate that a technician should verify that there are no pending catastrophic problems.
	Car voltage is low	
Inserted DISC does not play	Un-Playable DISC type inserted	
	Playable DISC type inserted	Eject and Re-insert DISC
	DISC is inserted upside-down	Re-insert DISC with label side up
	DISC is dirty	
	DISC is damaged	
Playback Picture has distortion or is un-viewable		Check SETUP options
Playback Freezes or Stops abnormally during playback	Dirty or Damaged DISC	Replace DISC
Remote Control does not work	Old batteries	Check batteries
		Point Remote Control directly at monitor
No Subtitles	DVD Contains no subtitles	No subtitles available for display
	Subtitles are turned off	Press the SUBTITLE button to select from the available subtitles
Subtitles will not appear	Playing DVD prohibits turning off of subtitles	
Audio language or subtitle language cannot be changed	Playing DVD prohibits language change	Cannot change language
	Playing DVD prohibits language change	

BASIC TROUBLE SHOOTING

Symptom:	Cause:	Correction:
Selected audio language or subtitle language is not used	A language not stored on the DVD playing was selected	A language not stored on the DISC cannot be selected
Aspect ratio selected during setup is not used	An aspect ratio not stored on the playing DVD was selected	An aspect ratio not stored on the playing DVD cannot be viewed
Viewing Angle cannot be switched	The DVD playing contains only one angle, or multiple angles are not available for the current scene	Angle cannot be switched if DVD does not contain multiple viewing angles See ANGLE MARK setup for notification of presence of multiple viewing angles
	The playing DVD is prohibiting viewing angle selection	

Attachment

1. Setup of DVD MONITOR:

- *Use normal round DVD, Insert DVD correctly, if DVD is inserted incorrectly the DVD player will lockup.
- *Make sure that the DVD is clean and scratch free.
- *Keep DVD in a clean and safe place.
- *Extreme temperature may be affect the DVD player, if that happens, turn off the unit for one hour in safe place.
- *If you leave DVD in car under sunlight it will warp and become unusable.
- *Forcing warped DVD into player will void warranty.

2. DVD-Disc

- *Some discs may not be compatible with this unit.
- *This unit can play recorded DVD-R/DVD-RW, some down loaded video may not be compatible.
- *Broken, dirty or wet disc can not be read by this unit.
- *Please use ◀ ▶ ▲ ▼ to choose the file when play MP3 disc, closed by ENTER.

3.REMOTE CONTROL:

- *Keep remote control away from direct sun light.
- *Summer high temperatures will distort the functions the remote control.
- *High heat and extreme cold will reduce the range of the remote control. Move remote closer to unit if this happens.

4.LCD

- *Do not press or touch LCD screen, this may cause distort on or failure.
- *Use dampd soft cloth to clean LCD screen (USE ONLY WATER).
- *Do not use cleanser or any type of chemical cleaners.
- *In extreme cold or heat, it is normal to see some red or blue pixels, this will correct when temperature gets to normal.

Accessories list

Item no	description	QTY
1	remote control	1
2	manual	1
3	mounting screws	1 bag

Specifications

Screen Size:	10.4 inch
Display Profile Ratio:	4:3
System:	PAL/NTSC
Power source/Consumption:	DC12V+/-20%, ≤1500mA
Video Input:	1way Composition Video signal
Video Output:	1way Composition Video signal
Audio Output:	1way L/R Output
Storage Temperature:	-30°C ~ +70°C
Display Method :	TFT Color LCD
Resolution(HxV):	640(H)x480(V)
Back light:	Cold Cathode Filament Tube
Monitor dimension:	285x295x45mm
Disc format:	MP3/DVD/VCD/CD/SVCD/CD-R/CD-RW/DVD-R/ DVD-RW
Disc zone:	Multizone

Cautions

- ※ Never connect this car monitor to cigarette lighters for such as trucks or buses which use 24V DC power.
- ※ Do not expose the monitor to high humidity,dust,steam,oily smoke, direct sunlight etc.
- ※ For your safety, turn power OFF when not in use.
- ※ Never attempt your own maintenance.Consult your TV dealer or the company.
- ※ Avoid dropping and strong impact.
- ※ For your safety,the driver should not watch the Monitor or operate the controls while driving.

WARNING:

DO NOT WATCH MONITOR WHILE VEHICLE IN MOTION, THIS MAY RESULT IN SERIOUS INJURY OR DEATH.

WIRING DIAGRAM

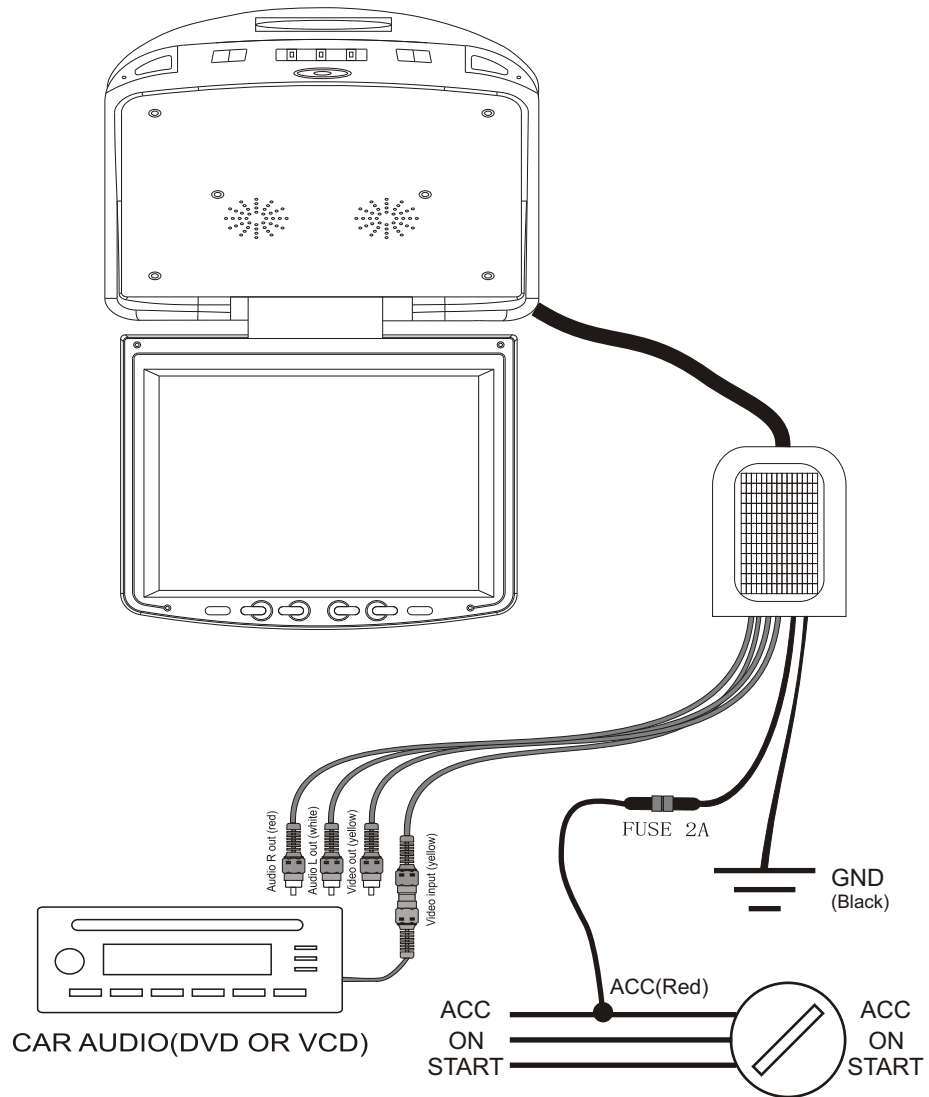



[HTTP://WWW.PYLEAUDIO.COM](http://www.pyleaudio.com)

Free Manuals Download Website

<http://myh66.com>

<http://usermanuals.us>

<http://www.somanuals.com>

<http://www.4manuals.cc>

<http://www.manual-lib.com>

<http://www.404manual.com>

<http://www.luxmanual.com>

<http://aubethermostatmanual.com>

Golf course search by state

<http://golfingnear.com>

Email search by domain

<http://emailbydomain.com>

Auto manuals search

<http://auto.somanuals.com>

TV manuals search

<http://tv.somanuals.com>