

PYLE®

OWNER'S MANUAL

PLTS72U



- 7" Motorized 16:9 TFT-LCD Display**
- Touch Screen Capable**
- Car DVD/VCD/MP4/CD/MP3 Player**
- Front Panel USB/SD port & Aux input**
- Built-in AM/FM Tuner & RDS**
- Switchable USA/Europe Radio Frequency**
- Wireless Remote Control**

INSTRUCTIONS

CONTENTS

Welcome	3
Warning.....	3
Note	4
Features	5
Basic Operation.....	6
Panel Arrangement	7
Basic Functions	8
Main Menu Touch Operation.....	12
OSD Setup	13
Adjust Mode.....	14
Remote Control Function	15
Loading	17
Disc Play Touch Operation.....	18
DVD Mode	19
RDS Touch Operation	21
Radio Operation	23
DVD Basic Operation.....	24
VCD Basic Operation.....	34
CD/MP3 Basic Operation	37
MP3/USB/SD Operation	39
Music Surroundings Setting/EQ Setting	40
Audio Frequency/Tone.....	41
Other Play Mode.....	42
Trouble Shooting	43
Wiring Diagram	44
Specifications	45

WELCOME

Thank you for enjoying our series of digital car A/V product.

To properly use this product, please go through this instruction manual for installation and operation, put it in a safe place for future use!

WARNING

1. Please keep the disc slot clean, wipe it off when there is some dirt on it. You should wipe off any dirt on the disc before you place it into the unit. If the disc is dirty and you place it inside the unit, it will cause the unit to go into an error and will not play the disc. Please ask professional to clean the laser.
2. Playing the radio at higher volumes for a long period of time may cause hearing issues. You should play this unit at a moderate listen level.
3. This unit is set up by precision parts. If you open up this unit, you will void any and all of your warranty.
4. Please do not touch LCD display with any hard object so that you prevent it from getting scratched or damaged.
5. To avoid an accident caused by watching the LCD screen. This unit has a vehicle lock out wire so that you will not be allowed to watch a video while driving down the road.
6. This unit is meant for a 12V power and negative ground system from a vehicle.

NOTE:

We keep improving this product all the time. There may be some changes in it that are not in this manual.

INSTRUCTIONS

NOTE

- This unit can play the following disc

MODE	ICON	CONTENT	DISC SIZE
DVD	DVD	Sound, image	12cm
VCD	VCD	Sound, image	12cm
MP3	MP3	Sound only	12cm
CD	CD	Sound only	12cm

Note: 1. This unit is compatible with MP4/DVD/VCD1.0/2.0/3.0 version, DVD, CD-R, CD-RW, MP3, WMA, JPEG.
2. When playing a DVD, VCD, MP3, CD disc the display will auto identify the disc and show corresponding word. When  appears on the display, that means that there is no function, please choose another mode.

- It may lead to accident if you are going to change unit.
- Playing disk during car run on bumpy road will damage laser. Playing substandard disc or damage disc will damage laser.
- The environment of inside car is not good, too much dirty, please clean the laser by laser cleanser timely.
- Do not work under terribly hot or cold environment, please ensure the temperature in car is in $-20^{\circ}\text{C} \sim 60^{\circ}\text{C}$.
- During operation, if  appear on LCD, that means unit do not support that function, operation is invalid.
- When unit is showing some abnormal, please refer to TROUBLE SHOOTING in this instruction manual, If you cannot find any solution, please press RESET to resume to initial status.

FEATURES

DVD PLAYER

1. International advanced MPEG-4 DECODE TECHNOLOGY
2. COMPATIBLE WITH MP4 (AVI/DIVX/5.X), DVD(DVD-R/DVD-RW), VCD, SVCD, CD-RW, WMA, MP3 JPG
3. Multiple subtitles, angles, languages supporting, Child lock function
4. 4 CHANNEL AUDIO OUTPUT MODE
5. PAUSE, PLAY, UP/DOWN, STOP, ZOOM, PBC FUNCTION
6. FM/AM RADIO TUNER
30 RADIO STATION (18FM, 12AM)

LCD DISPLAY

1. 7 inch, 16:9 TFT LCD display
2. Touch screen
3. Auto adotoried panel
4. Angle of turn adjustable

INSTRUCTIONS

BASIC OPERATION

1. SOURCE ON/OFF

Press SRC button on panel or PWR button on remote control quickly to power on.
Press SRC button on panel or PWR button on remote control longer to power off.

2. PLAYING SOURCE CHOOSE

Press SOURCE button on remote control, unit will switch sources in the following sequence: RADIO → DVD → AUX

3. MUTE CONTROL

Press MUTE button on panel or MUTE button on remote control shortly to turn off sound output, press again to back to sound output.

4. VOLUME ADJUSTMENT

- 1) Press VOL+/VOL- button on panel, VOL+/VOL- button on remote control or touch button on display to adjust volume level.
- 2) The volume setting on this unit is 0 - 39.

5. TONE MODE ADJUSTING (SEL)

Press SEL button on remote control or SEL button on the panel to choose your desired tune mode:

VOL → BAS → TRE → L/R → F/R
↑──────────────────────────┘

NOTE:

- 1) DVD playing mode, MBP & User will be automatically activated.
- 2) After 5 seconds you choose desired mode, do not adjust volume button. The mode will automatically take you back to status before adjustment.

6. RESET

- 1) If unit is not working correctly, you should press the RES button. This will reset the radio and should start working correctly afterwards.
- 2) After reset, all settings will resume back to the factory default settings.

PANEL ARRANGEMENT

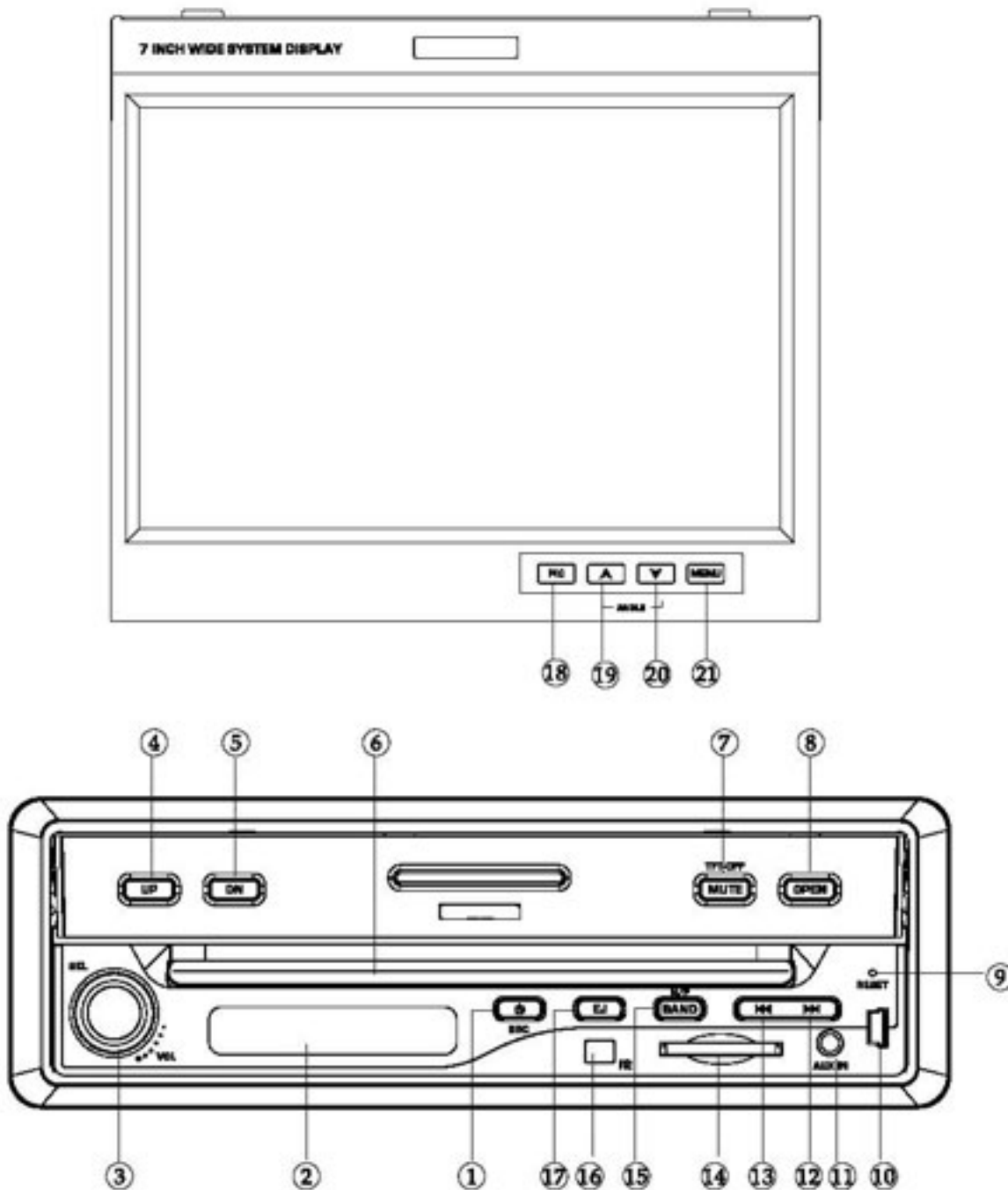

PANEL BUTTON CONTROL INSTRUCTION

- 1.SRC on/off/function MODE button
- 2.LCD Display window
- 3.(VOL/SEL)Volume adjustment mode
- 4 .UP Adjustment (TFT Screen)
5. DN Adjustment(TFT Screen)
- 6.Disk load slot
- 7.MUTE button/TFT ON/OFF
- 8.OPEN button
- 9.Reset button
- 10.USB Socket
- 11.AUX External Input
12. ▶ Selection/Next/Hang-up
13. ◀ Selection/Previous/hand-free
- 14.SD Socket
- 15 .Band button/N/P
- 16.Remote Controller Receiving Window
- 17.Disk Out button
- 18.PIC Color Selection button
19. ▲ UP Adjustment
20. ▼ Down Adjustment
- 21.MENU button

OUTLOOK AND BASIC FUNCTION

1.SRC on/off/function MODE button

Press this button for a short moment to turn on power, and long press it to turn off power. Every button-press activates mode change as follows:

Note:When the device without connecting to USB.SD,CDC or DVD no disc inside ,the system will automatically skip these related working mode.

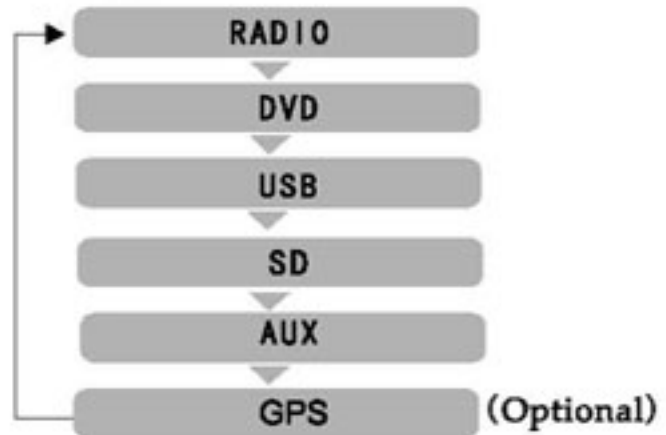

2.LCD Display Window

Under radio mode: channel and frequency are displayed; Under PLAY mode, the directory of the song and time elapsed are displayed.

3.(VOL/SEL)Volume adjustment mode

Repeat pressing this button can select the VOL.BAS .TRE,BAL,FAD adjustment mode. then can rotate the button to adjust Volume ,BAS,TRE,BAL,FAD as your likes.

4. UP Adjustment (TFT Screen)

After the display screen is extended, press this button to adjust the upward view angle of the screen in 5 steps of adjusting angle.

5. DN Adjustment (TFT Screen)

After the display screen is extended, press this button to adjust the downward view angle of the screen in 5 steps of adjusting angle.

6.Disk load slot

Opening for disks to enter or retreat.

7.MUTE button /TFT ON/OFF

Press this button for the first time to turn off audio output, and press again to restore to the original audio output. Press this button longer to turn on/off TFT LCD display.

INSTRUCTIONS

8. OPEN button

Press this button to extend the TFT screen from the device or retreat it back. The maximum angle of extension is 104 degree.

Attention: Under the disk playing mode, there is no image display at the moment of screen extension after the button is pushed. It will become normal in 3 seconds.

9. Reset button

Press this button to reset the device to its initial state.

10. USB Socket

This is a high-speed transmission interface, which can read high-capacity data in MP3 or MP4 format.

11. AUX External Input

External audio input socket.

12. ► Selection/Next

At the Radio state: short press this button can adjust the radio frequency down by single step, long press the button can seek down the radio station automatically. At TV state: short press this button to select next channel. Long press it can adjust the frequency step by step. In the play state: short press this button to select the next song. Long press it can do fast forward at X2.X4.X8.X16.X20's speed.

13. ◀ Selection/Previous

At the Radio state: short press this button can adjust the radio frequency by single step. long press the button can seek up the radio station automatically. At TV state: short press this button to select previous channel. Long press it can adjust the frequency step by step. In the play state: short press this button to select the previous song. Long press it can do fast backward at X2.X4.X8.X16.X20's speed.

14. SD Socket

This is a high-speed transmission interface, which can read high-capacity data in Mp3 or Mp4 format.

15. Band button/N/P

In radio state: short press this button can select the band switch. Each time's press. The sequence as following:



In Play state: Short press this button can select following 3 video system



In TV mode: Short press this button can select TV system:

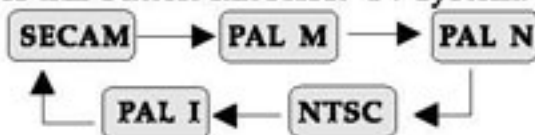

16. Remote Controller Receiving Window

It receives infra red signals from the remote controller which fits this device.

17. Disk Out button

Press this button to retreat the disk.

18. Pic Color Selection Button

Short press this button to chroma setup in the following level:

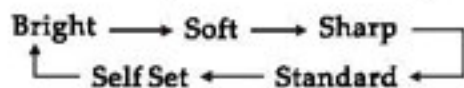

19. ▲ Up Adjustment

Operation and function are the same as in (4).

20. ▼ Down Adjustment

Operation and function are the same as in (5)

21. MENU button

Press this button shortly to turn off volume output, press again to resume former volume level.

INSTRUCTIONS

MAIN MENU TOUCH OPERATION (PIC 1)

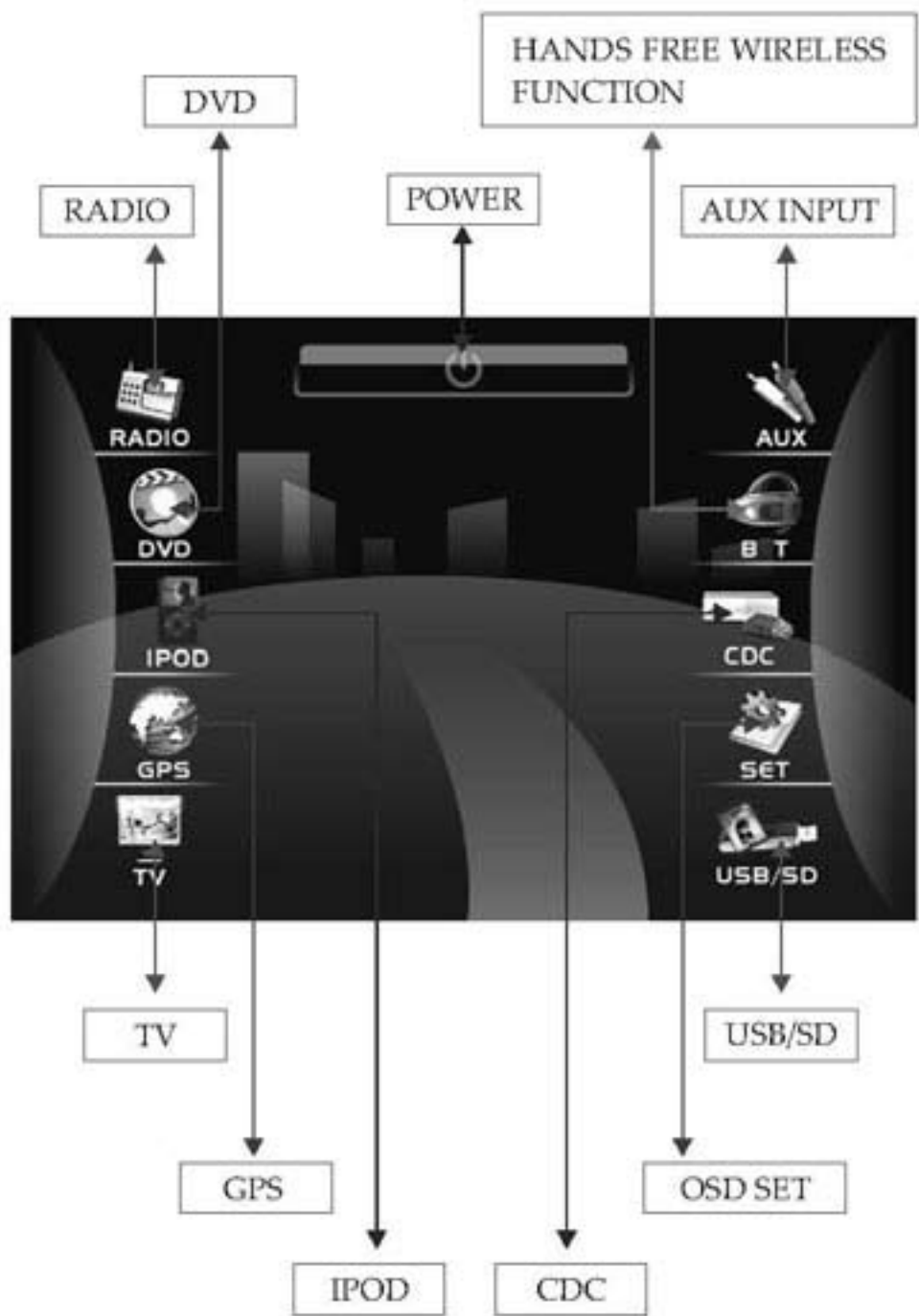

OSD SETUP (PIC 2)

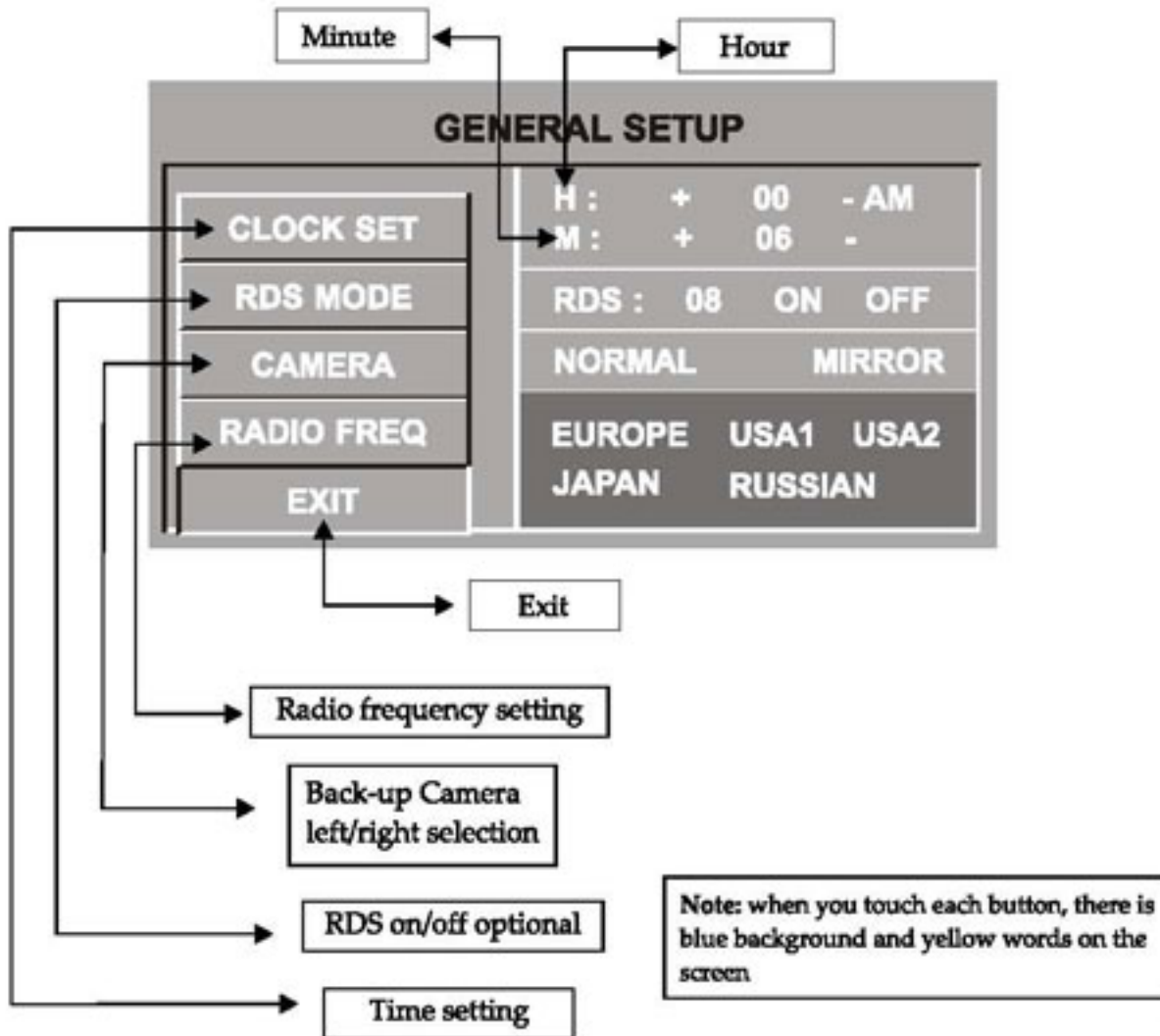

Note: There are 3 buttons automatically changed according to your setting change in radio state when you activate or exit RDS; Changes are as following: PTY ↔ LOUD ; TA ↔ EQ; AF ↔ ST

TIME DISPLAY AND ADJUST

Time display: Touch main menu into adjust mode, press time setup button, the corresponding function will be display in yellow words.

(1) Press "+" on hour to add hour, press "-" to reduce hour;

(2) Press "+" on minute to add minute, press "-" to reduce minute.

NOTE: Touch the correspondence function, will be display in green background.

The unit include two times system: Europe time (24 hour setup), America time (12 hour setup), when show the AM mark it indicate morning time, when appear the PM mark, it show the time of afternoon.

Remark: This unit is with RDS function, it will automatically adjust the time when you activate RDS function or have received RDS radio channels. At no received RDS radio channels or AM state, you should adjust the time.

INSTRUCTIONS

ADJUST MODE (PIC 3)

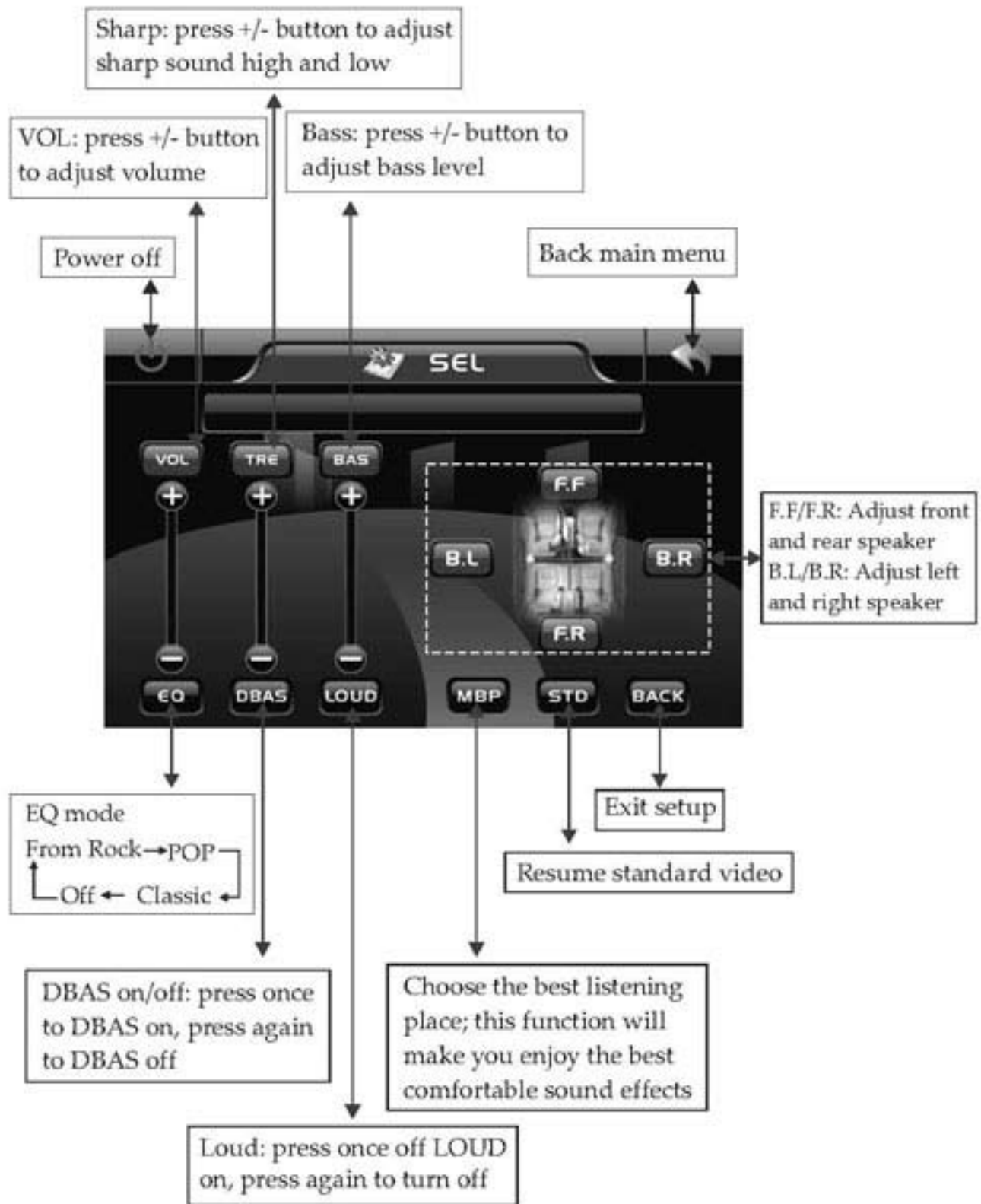

REMOTE CONTROL FUNCTION

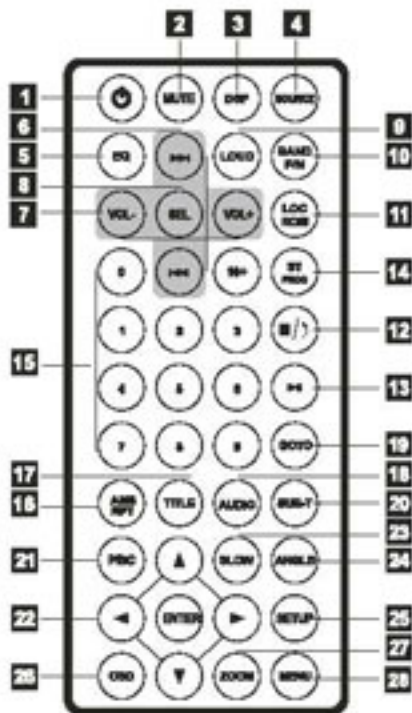

- | | |
|----------------|----------------------|
| 1 POWER ON/OFF | 15 0-10+ |
| 2 MUTE | 16 AMS/RPT |
| 3 TIME DISPLAY | 17 TITLE |
| 4 SOURCE | 18 AUDIO |
| 5 EQ | 19 SET PLAYING TIME |
| 6 SEEK+/SEEK- | 20 SUBTITLE |
| 7 VOL+/VOL- | 21 FBC/MENU |
| 8 SEL | 22 UP/DOWN/L/R ENTER |
| 9 LOUD | 23 SLOW |
| 10 BAND/ P/N | 24 ANGLE |
| 11 LOC / RDM | 25 SET UP |
| 12 STOP | 26 OSD |
| 13 PLAY/PAUSE | 27 ZOOM |
| 14 ST/PROG | 28 MENU |

1. POWER

Press once to switch on, press again to switch off.

2. MUTE Button

Press once to turn off audio output, press again to resume volume level.

3. DSP

Press this button to show the time.

4. SOURCE Button

Press this button to choose audio sources.

5. EQ Button

Press this button to choose POP, ROCK, EQ off.

6. SEEK + ($\blacktriangleright\blacktriangleright$) / SEEK - ($\blacktriangleleft\blacktriangleleft$) Button

Press this button to manual turning, speed or quick back, previous song and next song.

7. VOL + (\rightarrow) / VOL - (\leftarrow)

Press this button to increase or decrease volume level.

8. SEL Button

Press this button to choose sound feature.

9. LOUD Button

Press this button to startup LOUD function.

10. BAND - P/N Button

In radio mode, press this button to choose band. In VCD, DVD mode, press this button to choose AUTO, PAL or NTSC system.

11. LOC/RDM Button

In radio mode, press this button to switch between local and direction. In VCD, CD mode, press this key to randomly play.

12. STOP Button

Press this button to stop playing.

13. PLAY/PAUSE Button

Press this button to switch between play and pause. In stop mode, press this button to play.

14. ST/ PROG Button

In radio mode, press this button to choose stereo or mono station. In audio mode, it can help STOP button to programmed play.

INSTRUCTIONS

15. 0 - 10 + Button

Press this button to choose desired song, section, preset stations.

* Decimal numbers, for example the 19th song, press 1,9 button;

* Centesimal numbers, for example, the 120th song, press 1,2,0 button.

16. AMS / RPT Button

In radio mode, press this button to browse stored stations. In audio mode, press this button to play repeatedly.

17. TITLE Button

In DVD mode, press this button to play back to the top menu of disc.

18. AUDIO Button

In DVD mode, press this button to switch language of dialogue. In VCD mode, press this button to choose left track, right track, and stereo.

19. SET Playing Time

In DVD mode, press this button, you can define playing time.

20. SUBTITLE Button

In DVD mode, press this button to switch language of subtitle.

21. PBC Button

In VCD mode, press this button to display all song menus, work with number button to choose songs.

22. UP, DOWN, LEFT, RIGHT, ENTER Button

In DVD mode, press this button to move cursor up, down, left, right to choose item in menu. Press the enter button to confirm choice.

23. SLOW Button

In audio mode, press this button to slow backward and slow forward.

24. ANGLE Button

In DVD mode, press this button to change play angle.

25. SETUP Button

In audio mode, press this button to choose different set items.

26. OSD Display

Press this button to display the title chapter and the left time.

27. ZOOM Button

In DVD/VCD mode, press this button to ZOOM in. In CD/MP3/USB/SD mode, press this button to choose EQ.

28. MENU Button

Press button to back to the main menu.

BATTERY CHANGE

When control distance of remote control becomes shorter or no function, please change battery. Please confirm polarity before change.

One hand press stopper, then pull out battery.



Put battery into controller.



Insert battery holder into controller.



LOADING

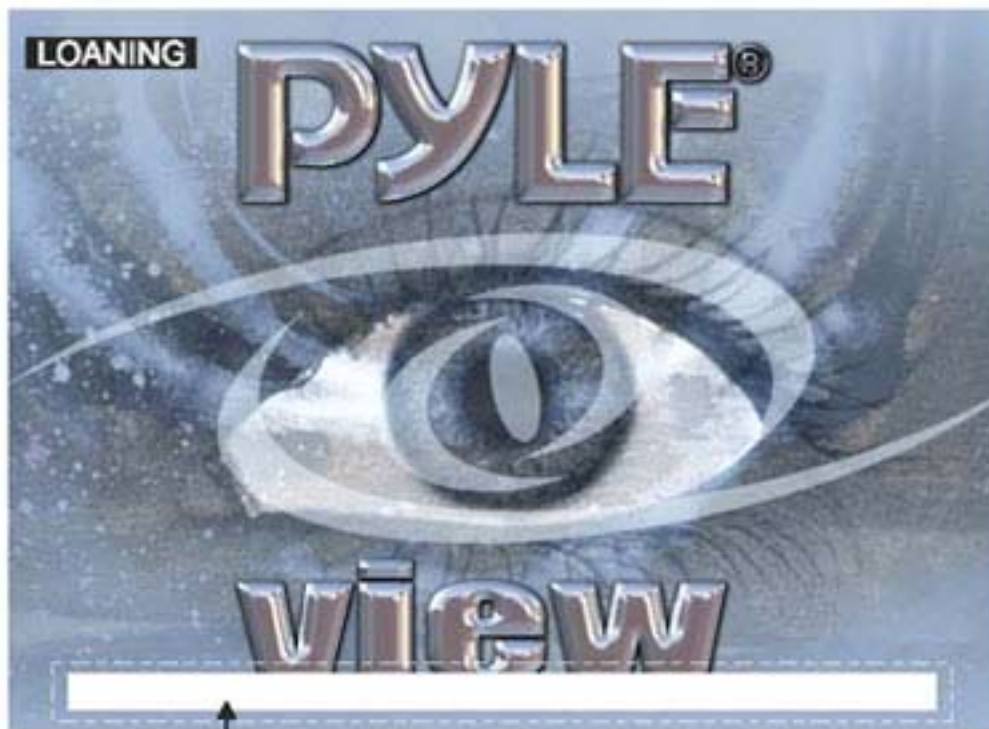

This white bar shows the rate of process of loading a disc.

Note: When loading a disc, touch screen function can not be used.

INSTRUCTIONS

DISC PLAY TOUCH OPERATION (PIC 4)

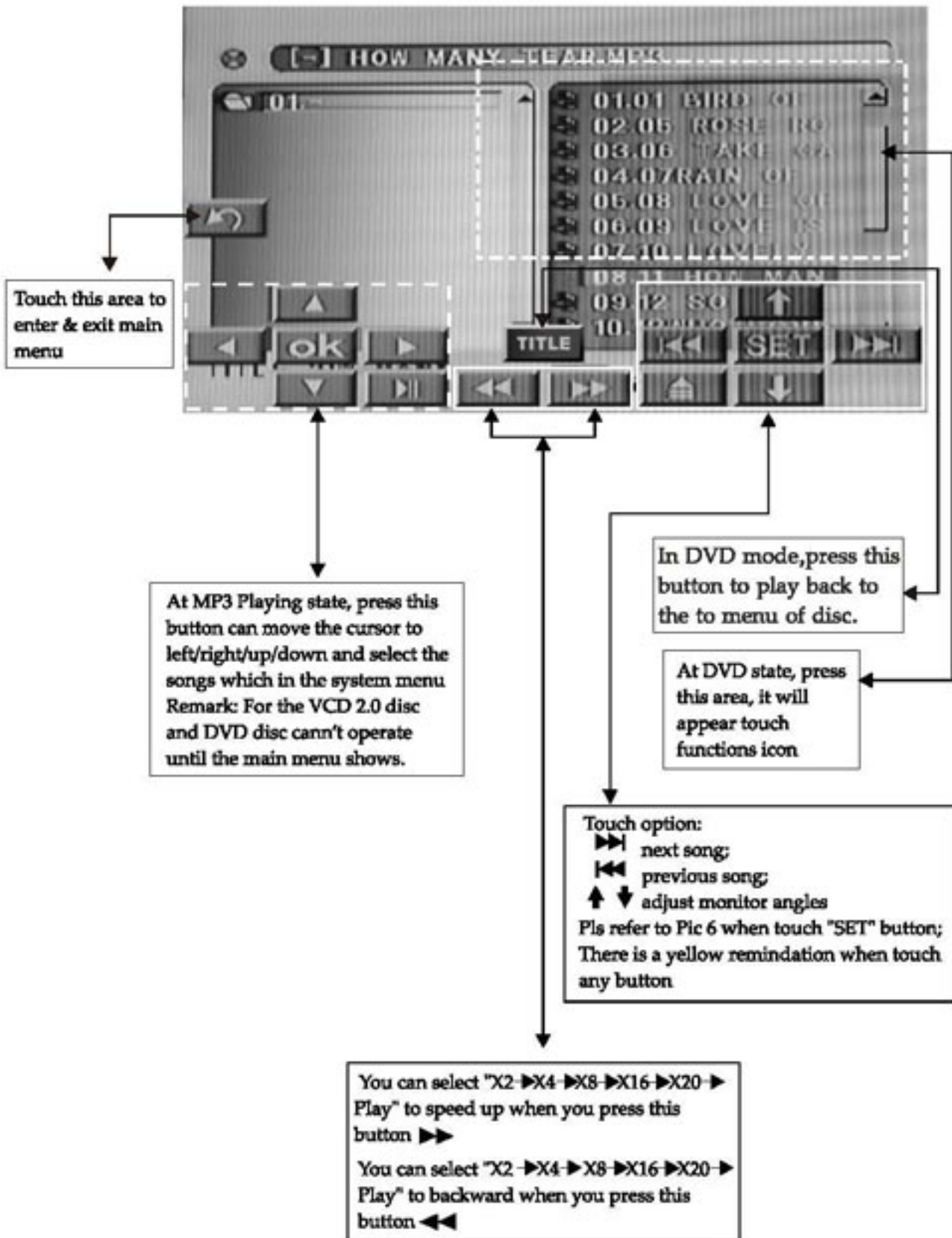

DVD MODE (PIC 5)

AUDIO SETTING ON TOUCH SCREEN

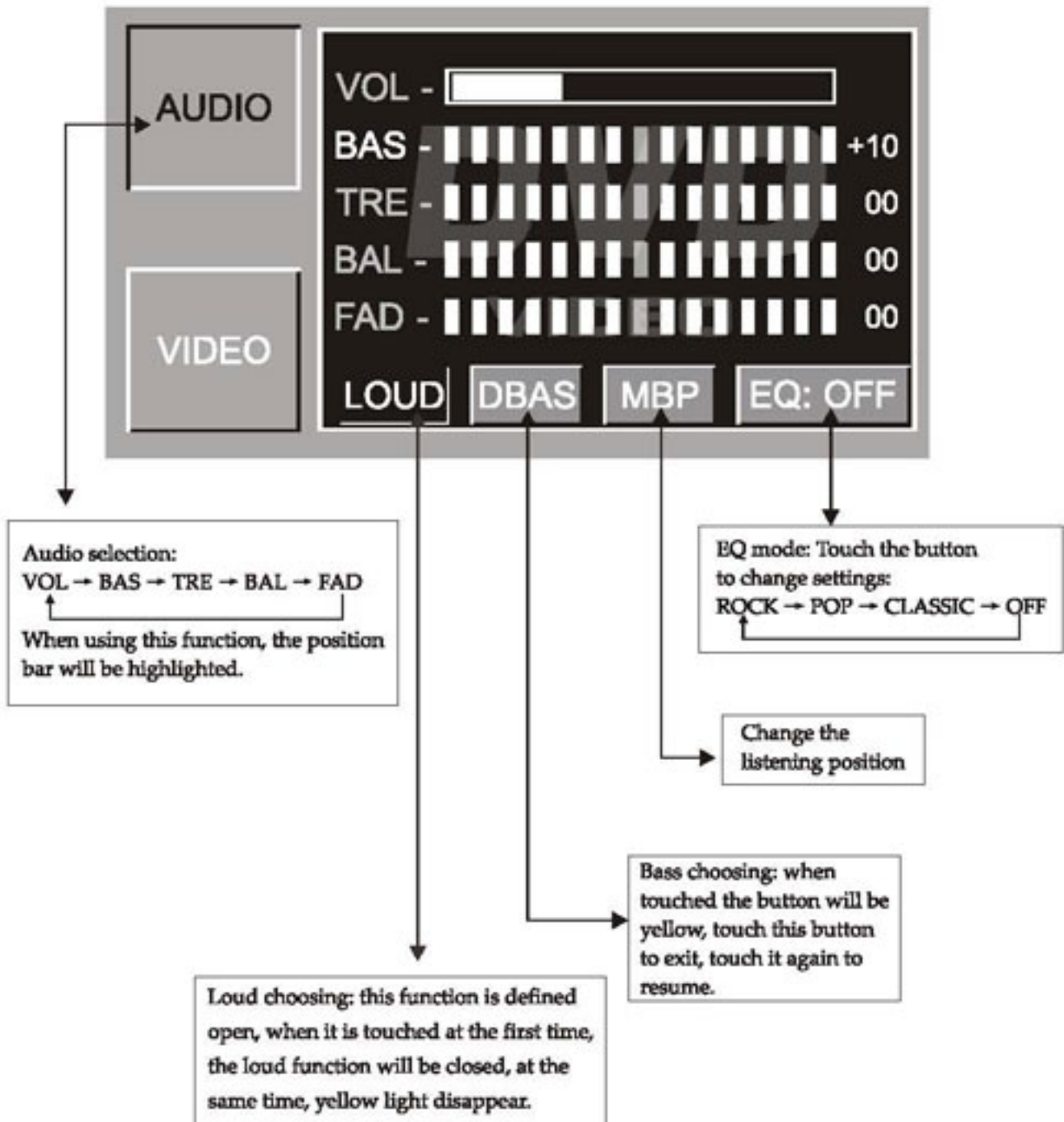

INSTRUCTIONS

VIDEO SETTING ON TOUCH SCREEN

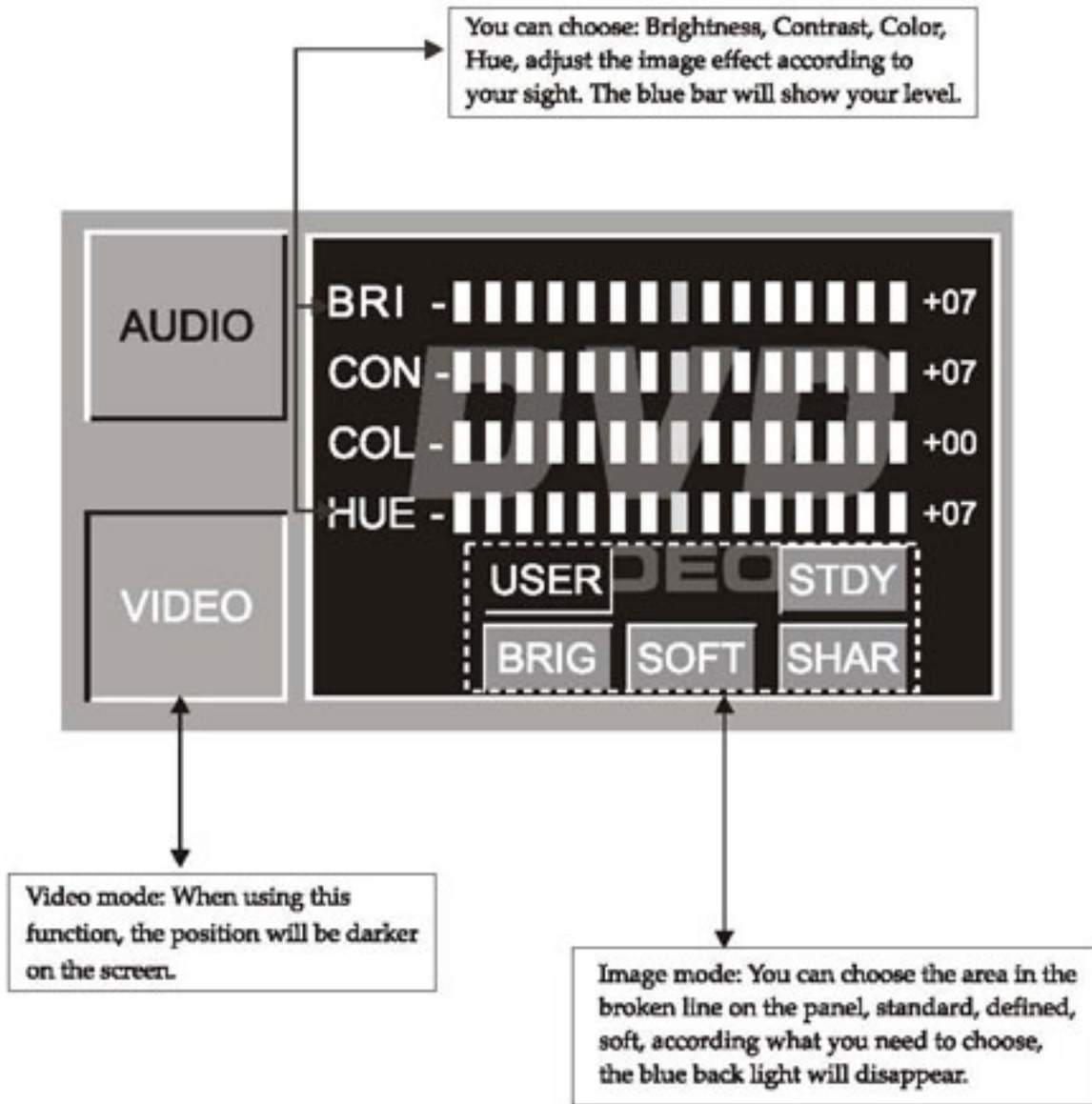

RDS TOUCH OPERATION (PIC 6)

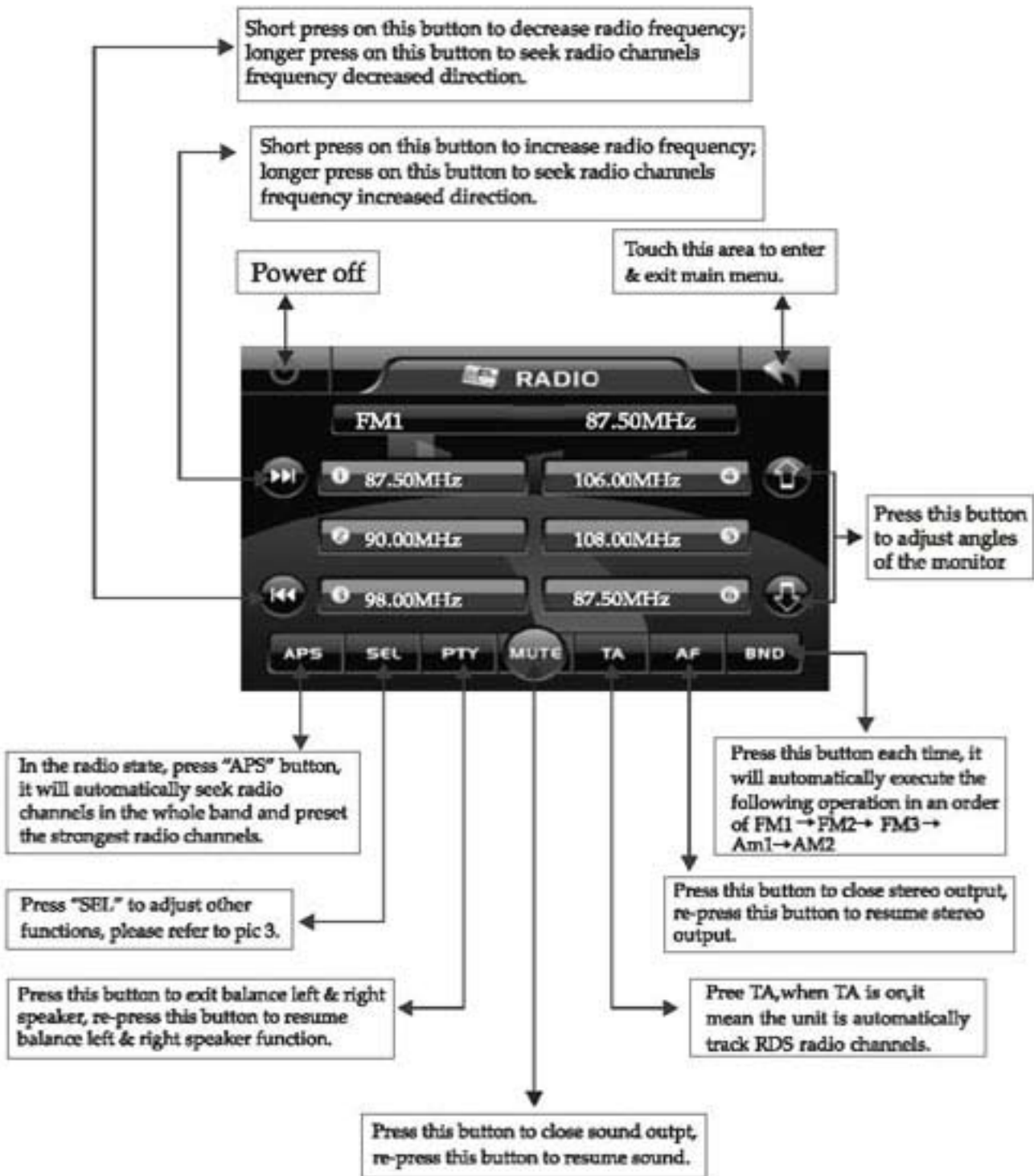

+ For details of RDS operation, please refer to other instruction

INSTRUCTIONS

RDS

1. EON(RDS Mark)

Indicate main unit is on auto tracking RDS mode

2. AF(RDS auto tracking mark)

Indicate radio is auto tracking RDS channel

3.TA(RDS signal increasing output)

Indicate RDS channel have signal increasing output

4.TP(RDS channel stereo mark)

Indicate RDS channel is on stereo playing mode

5.POP.M....(RDS channel mark)

Indicate RDS channel name

I . RDS Tracking System

Press AF button in FM mode, and then press **◀/▶** last 2 minutes, RDS will auto search channel up and down, it will stop searching when RDS channel be founded, but "AF" will keep shinning on the screen and wait for the next traffic emergency report.

II . RDS Tracking on playing mode

In playing mode, "AF" tracking system keep on opening and wait for traffic emergency report.

1). PTY: RDS button, press once will show music mode POP, press 1-6 function memery button, every group have 2 channel.

POP M	POCRM	EASYM
LJGHTM	CLASSICS	OTHETM
JAZZ	LOUNTRG	NATION

2).press PTY button twice, and then press 1-6 function memery button, every button have 3 channel.

NEWS	AFFAIPS	LIFO	SPORT
EDNEAEE	DRARNA	CULTURE	SEIENLE
CHILDREN	SOCIE	RETIGION	PHONEIN
TRAVEL			

Note: RDS channel in broken line is in available.

AF: RDS auto search button, in radio mode also can press this button shortly auto tracking RDS channel, press this button shortly also can cancel RDS function.

TA: In RDS mode, press this button can output TA signal, also can recongnize RDS channel is exist, if no RDS signal TFT will show "NO.TA.TP"

RADIO OPERATION (Please look at picture #6)

1. Band Selection

In radio mode, press BAND button, BAND/P/N button on remote control, or touch position on screen every time to choose band, the sequence is as follows:

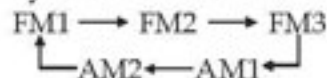

2. Adjust Frequency

Manually Adjust Frequency:

Press SEEK + button on remote control, or ►► touch button on display shortly every time, frequency will increase one step by one step till you get desired frequency. Press SEEK - button on remote control, or ◀◀ touch button on display shortly every time, frequency will decrease on step by step till you get desired frequency.

Search Station:

Press SEEK + / SEEK - button on remote control, or ►►/◀◀ touch button on display shortly every time to search station in up/down direction. When get one station, it will auto stop searching.

3. Browse / Auto Search and Store Station

1) In radio mode, press AMS/RPT button on remote control, or APS button on display shortly to browse preset station on 1-6;

2) In radio mode, press AMS/RPT button on remote control, or APS button on display longer to auto search in whole band from present frequency and store 6 most strong frequency on 1-6;

3) This unit has FM1, FM2, FM3, AM1, AM2 Bands. Each band can store 6 stations, so a total 30 preset stations.

Note: After preset station, unit will cancel the former preset stations.

4. Mono/Stereo Selection

In radio mode, press ST/PTOG button on remote control or ST touch position on display to choose mono/stereo program.

Note: In radio mode, start up the stereo function automatic, touch the ST button again on the display, the TFT display will show the ST OFF & MOMO mark, that is to turn off the stereo. When the right under foot appear the MONO mark, it show the MONO on.

5. Manual Preset and Store Station

In radio mode, press 1-6 button on remote control, or 1-6 position on display longer to store preset frequency into preset channel. For example, the present frequency is 89.8MHz, press 2 button longer, then 89.8MHz frequency is stored in 2 channel.

INSTRUCTIONS

DVD BASIC OPERATION (Please link with touch operation at pic 4)

Slide in DVD disc, unit will play it automatically. If disc is in slot, press DVD touch button on main menu to play disc.

1. Pause Play

In playing mode, press **⏸** button on remote control, or **⏸** on the display to pause. Press again to go back to normal play.

2. Stop Play

In playing mode, 1) Press **■/⏏** button on remote control to enter the pause mode, the position will be stored in unit. At that time, press **⏸** button on remote control or touch button on display to resume playing at the stored position.

2) Press **■/⏏** button on remote control twice to enter into stop mode, here, press **⏸** button on remote control or touch button on display, unit will play from the first song.

3. Fast Forward/Fast Backward Play

In playing mode, press **SEEK +** button on remote control, or **▶▶** touch button on display to speed play.

When you need quick back, press **SEEK -** button on remote control, or **◀◀** touch button on display to quick back play.

Note: Hold above button a bit longer to operate.

4. Previous/Next Song Play

In playing mode, press **SEEK + / SEEK -** on remote control, or **▶▶/◀◀** touch button on display to choose previous/next song.

5. Switch System

In playing mode, short press the **BAND/P/N** button on remote control, to select PAL, AUTO, NTSC TV system.

Note: This function can only be worked by the remote control.

6. Slow Play

Press **SLOW** button on remote control to slow play. The level of slow playing is as follows. Sequence is :

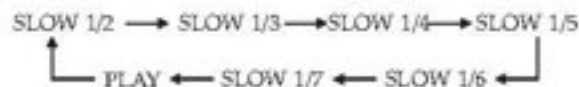

Note: This function can only be worked by the remote control.

7. Zoom In/Zoom Out

Press **ZOOM** button on remote control to zoom in / zoom out the picture. The levels are as follows:

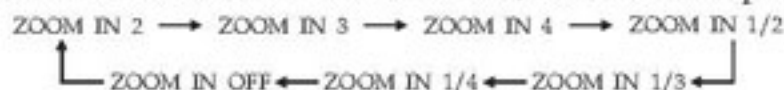

Note:

1. This function can only be worked by the remote control.
2. Image which is zoomed in can be moved by up/down/left/right cursor to move.
3. Image which is zoomed out cannot be moved.

8. OSD

In playing mode, short press OSD on remote control to show all information of present disc.

9. Repeatedly Play

In play mode, press AMS/RPT button on remote control to start up follow repeat function.



10. Angle Switch

If the DVD disc is recorded with multi-angles, you can press the ANGLE button to switch the angle during playing.

The sequence is as follow:

ANGLE 1 → ANGLE 2 → ANGLE 3

Note:

1. It just can be worked by the remote control.
2. It is only for the DVD disc which has multi-angle.
3. If there is a  sign on the cover of the DVD disc. The number in the sign means how many angles the disc has.
4. You can not switch the angle when slow playing.



11. Multi-Audio

There are different languages of dialogue and audio systems in DVD disc.

If the DVD disc is recorded with multi-audio, you can switch the language of dialogue and the audio systems when playing.

Press the AUDIO button repeatedly to change the language of dialogue.

Note



1. It just can be worked by the remote control.
2. It is only for the DVD disc which has multi-language.
3. If there is a  sign on the cover of the DVD disc,  means that it was recorded by multi-language/audio system.
4. In VCD mode, press the AUDIO button to select the L/R or STEREO track.

12. Multi-Subtitle

If the DVD disc is recorded with multi-subtitle, you can switch the languages of subtitle.

Press the sub-t button repeatedly to change the language.

Note:

1. It just can be worked by the remote control.
2. It only for the DVD disc which is recorded with multi-wubtitle.
3. If there is a  sign on the cover of the DVD disc  means theat it has several subtitle.

13. Title Select

In DVD mode, press TITLE button to back to the title menu. Display shows all the titles of the disc. You can select the chapter you want by the cursor, press play button to play the chapter.

Note: It just can be worked by the remote control.

INSTRUCTIONS

14. MENU Select

In playing mode, press PBC button on remote control to back to the menu, display will show chapter and section in disc. Work with ▲/▼ button on remote control or touch button on display to choose your desired song. Press ► button / ENTER button to play. Note: This function can only be worked by the remote control.

OPEN: Press OPEN button on panel to eject disc.

15. Program Play

In DVD mode, you can set the sequence of playing by the program function, the operation is as follow:

PROG	TC	TC	TC	TC			
1	01:03	5	__ : __	9	__ : __	13	__ : __
2	01:06	6	__ : __	10	__ : __	14	__ : __
3	__ : __	7	__ : __	11	__ : __	15	__ : __
4	__ : __	8	__ : __	12	__ : __	16	__ : __
		PLAY		DELETE			

When DVD is playing, press ST / PROG button, then display shows:

For example, program the first song, input 01, press ► button move the cursor to the second lattice, input desired song, for example, the third song. Program the second song, press ▼ button, move the cursor to 2___. input 01, press ► button move the cursor to the second lattice, input desired song, for example, the 6th song (press 6). Press ► button to program play. Back to the normal mode, press the ST/PROG button, then press ► button.

Note: This function can only be worked by the remote control.

16. Digital Album

Play the disc contains JPEG pictures, read the picture menu first.

1. Press ► button on remote control, the pictures will be browsed automatically. (It also can be worked to press number 6 button on the unit.)

2. Press ENTER button on the remote control, it can be manual browsed by SEEK + and SEEK -.

3. ZOOM in picture function: During auto browsing, press pause button stop the screen, press ZOOM button to zoom in or zoom out the picture. During manual browsing, you can press ZOOM button to zoom in or zoom out picture directly.

4. Under zoom in picture, you can move the picture by .

Note: You can not move picture in normal mode and zoom out mode.

17. Setup

Press SETUP button, display will show the system setup menu and the submenu, select the item you want by , after selecting the proper item, press ▲/▼/◀/▶ to press ENTER to confirm.

Note:

1. It just can be worked by the remote control.

2. Some function setting maybe different because of the different model or disc.

3. If the selected language is not recorded in the disc, then unit will show the appointed language,

4. About the "SETUP", please read the follow.

Press "SETUP" on the remote control, it will appear the following touch menu:

SYSTEM SETUP

1. Press ▲ or ▼ button

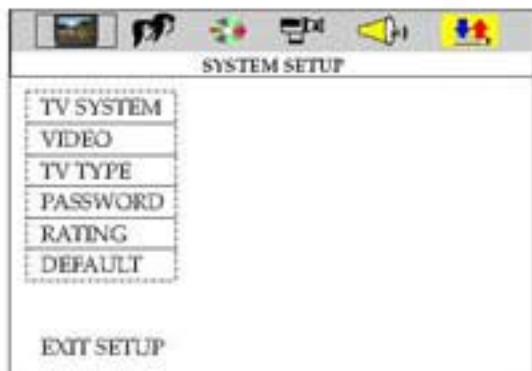

2. Press ▲/▼/◀/▶ button, then to enter.

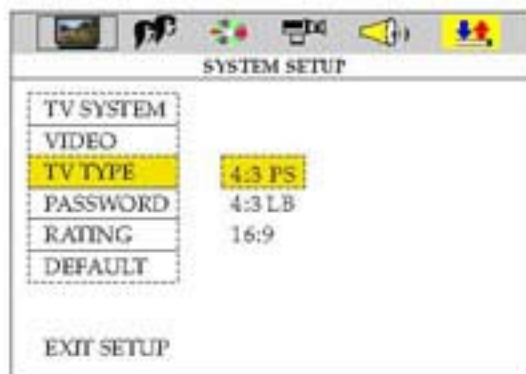
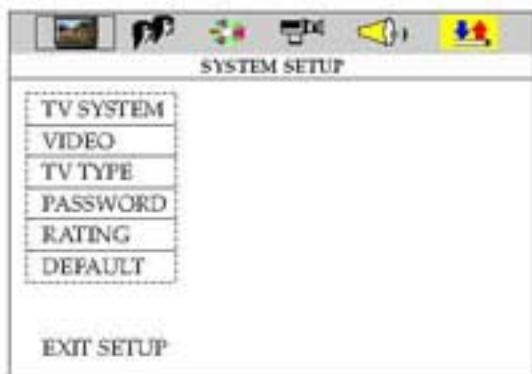
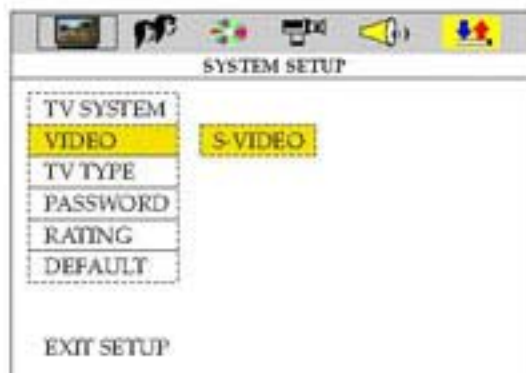
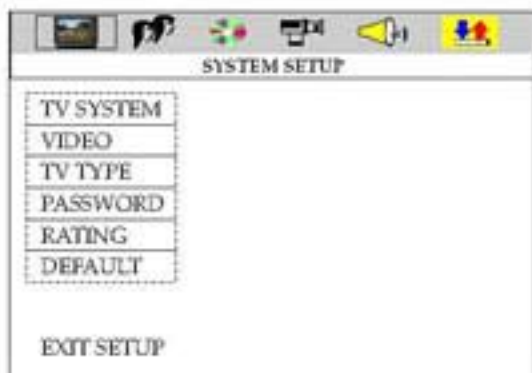
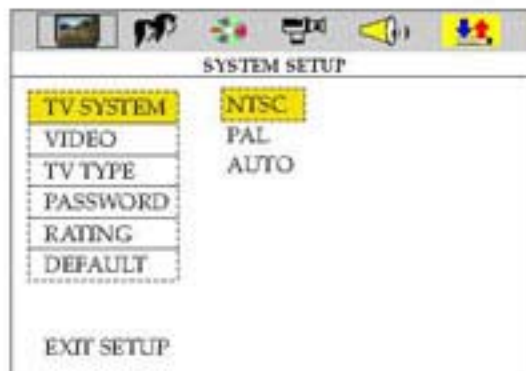

INSTRUCTIONS

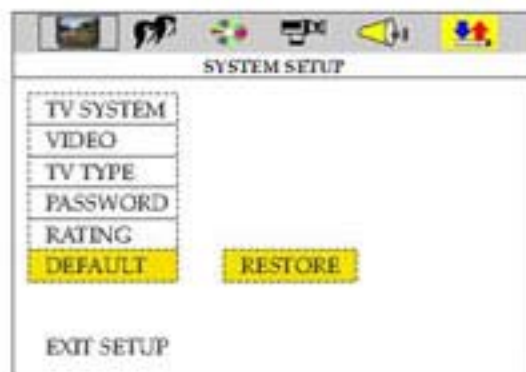
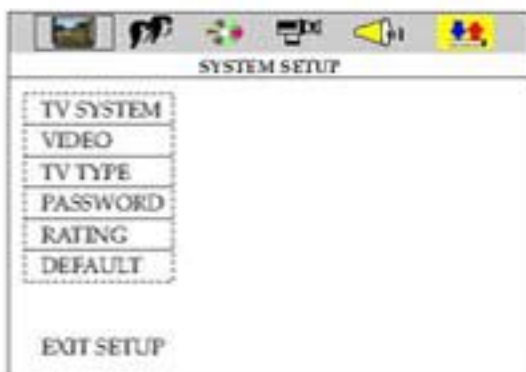
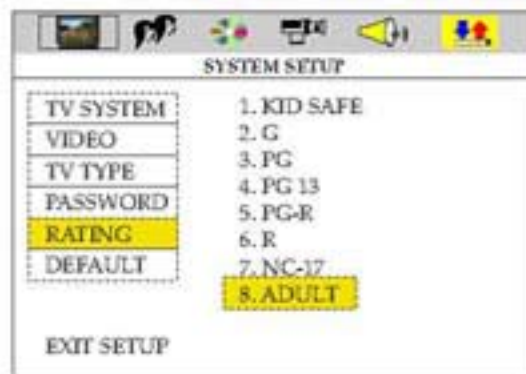
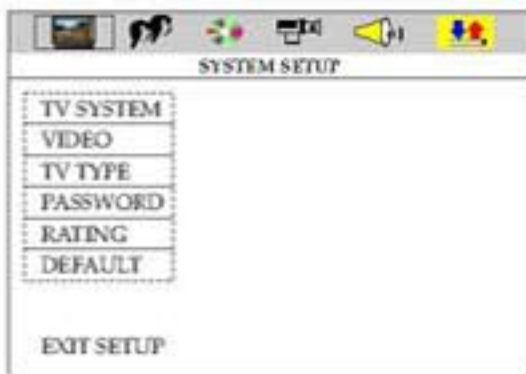
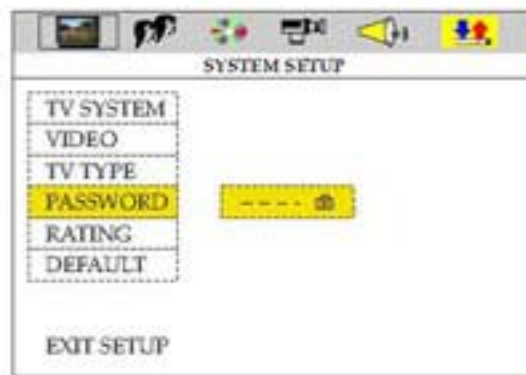
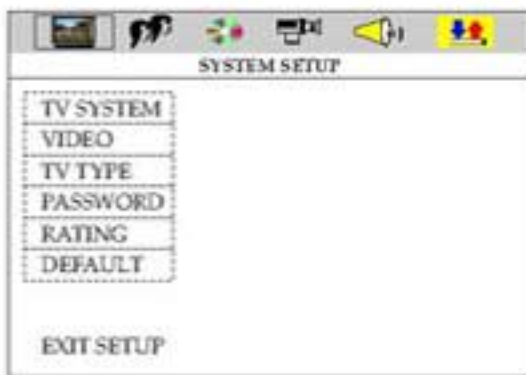

Note:

1. After input code "0000" press ENTER button to turn on child lock;
2. Move cursor to level item, choose desired level;
3. Only child lock is in can you choose.

LANGUAGE SETUP

1. Press ▲ or ▼ button



2. Press ▲/▼/◀/▶ button, then to enter.



INSTRUCTIONS



AUDIO SETUP

1. Press ▲ or ▼ button

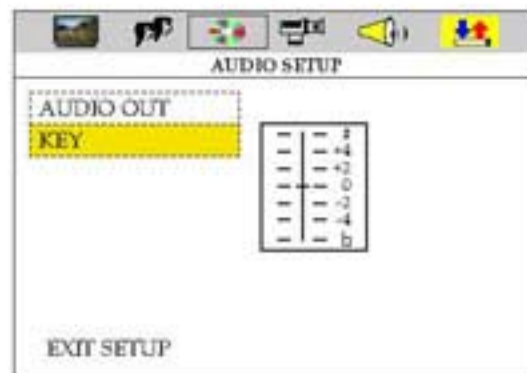
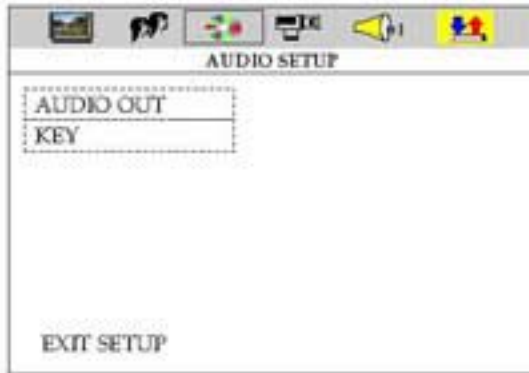

VIDEO SETUP

1. Press ▲ or ▼ button



2. Press ▲/▼/◀/▶ button, then to enter.



INSTRUCTIONS

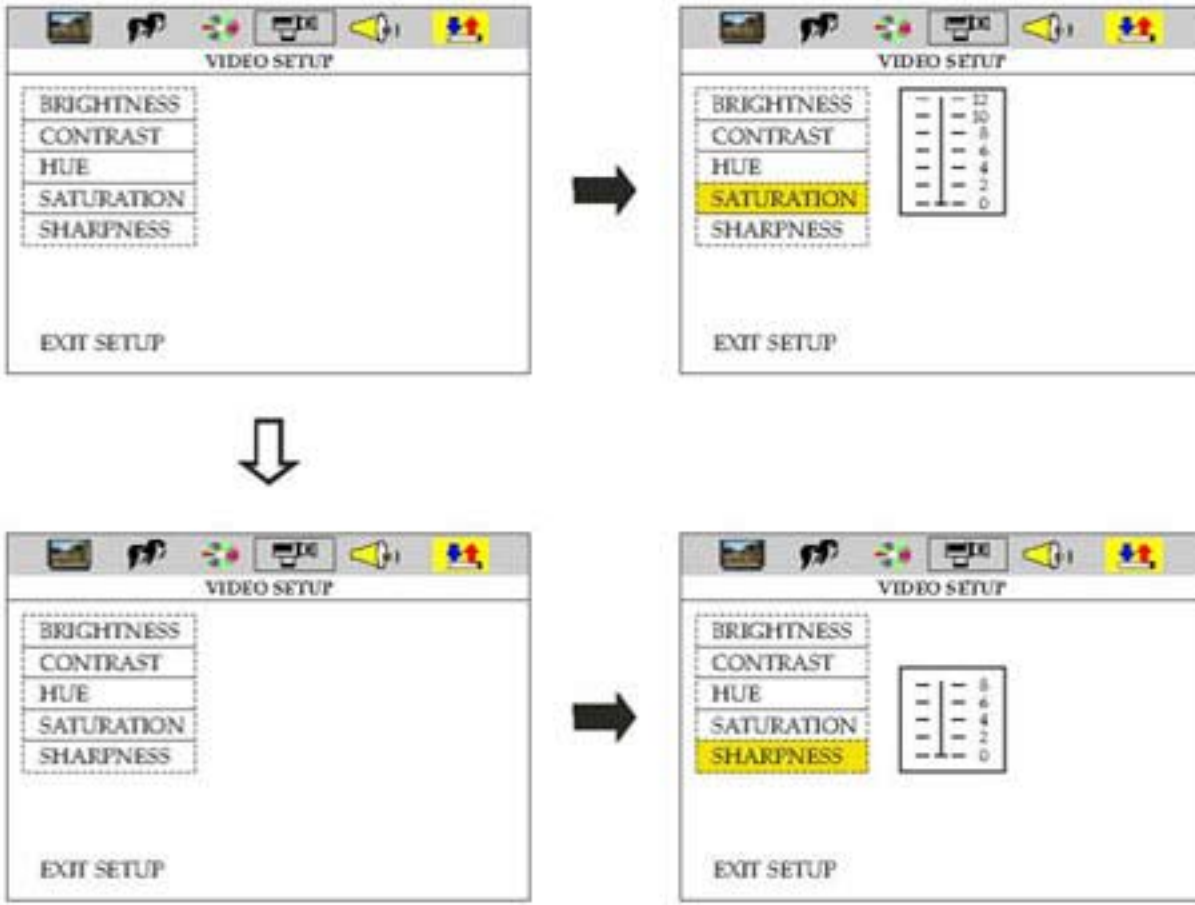

DIGITAL SETUP

1. Press ▲ or ▼ button

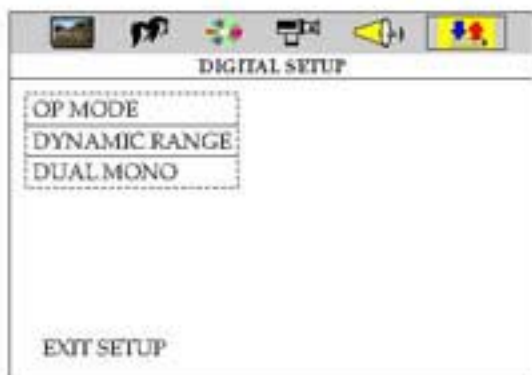
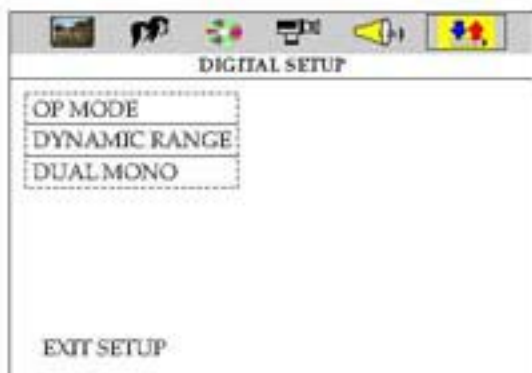
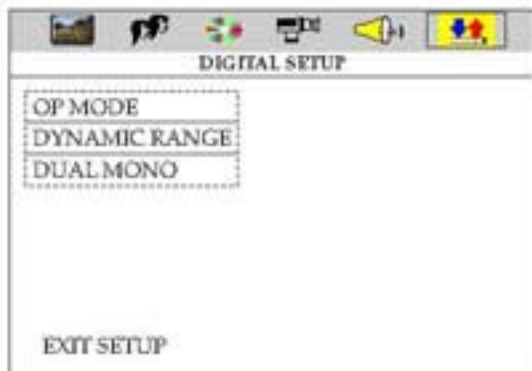

2. Press ▲/▼/◀/▶ button, then to enter.

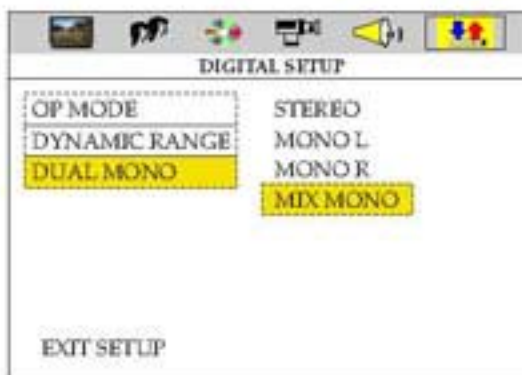
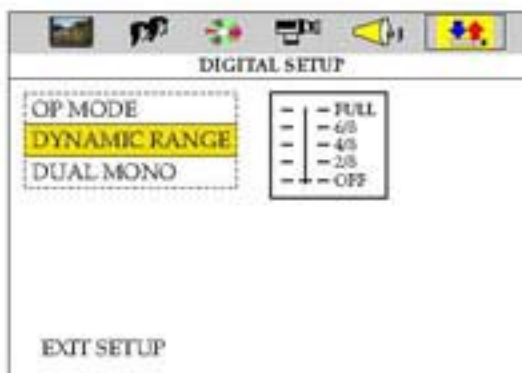
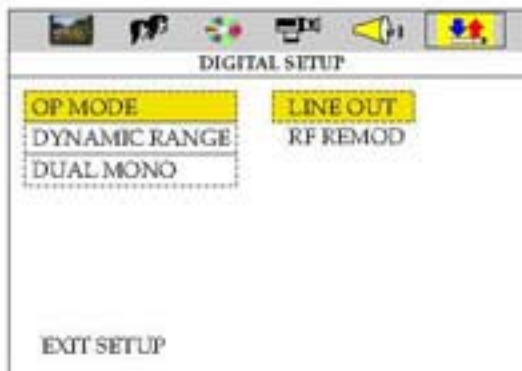

INSTRUCTIONS

VCD BASIC OPERATION (Look at picture #4)

Slide in the VCD disc, it will play it automatically. If the disc is in slot, press DVD touch button on main menu can to play.

1. Pause Play

In playing mode, press **⏸** button on remote control, or **⏸** on display to pause. Press again to back to normal play.

2. Stop Play

In playing mode, 1) Press **⏹** button on remote control to enter the pause mode, the position will be stored in unit. At that time, press **⏸** button on remote control or touch button on display to resume playing at the stored position.

2) Press **⏹** button on remote control twice to enter into stop mode, here, press **⏸** button on remote control or touch button on display, unit will play from the first song.

3. Fast Forward/Rewind Function

In playing mode, press **SEEK +** button on remote control, or **⏩** touch button on display to speed play.

When you need quick back, press **SEEK -** button on remote control, or **⏪** touch button on display to quick back play.

Note: Hold above button a bit longer to operate.

4. Previous/Next Song Play

In playing mode, press **SEEK + / SEEK -** on remote control, or **⏮ / ⏭** touch button on display to choose previous/next song.

5. Switch System

In playing mode, short press the **BAND/P/N** button on remote control, to select PAL, AUTO, NTSC TV system.

Note: This function can only be worked by the remote control.

6. Slow Play

Press **SLOW** button on remote control to slow play. The level of slow playing is as follows.

Sequence is :

```
graph LR
    S12[SLOW 1/2] --> S13[SLOW 1/3]
    S13 --> S14[SLOW 1/4]
    S14 --> S15[SLOW 1/5]
    S12 --> P[PLAY]
    P --> S17[SLOW 1/7]
    S17 --> S16[SLOW 1/6]
    S16 --> S15
```

Note: This function can only be worked by the remote control.

7. Zoom In / Zoom Out

Press **ZOOM** button on remote control to zoom in / zoom out the picture. The levels are as follows:

```
graph LR
    Z2[ZOOM IN 2] --> Z3[ZOOM IN 3]
    Z3 --> Z4[ZOOM IN 4]
    Z4 --> Z12[ZOOM IN 1/2]
    Z2 --> ZOFF[ZOOM IN OFF]
    ZOFF --> Z14[ZOOM IN 1/4]
    Z14 --> Z13[ZOOM IN 1/3]
    Z13 --> Z12
```

Note:

1. This function can only be worked by the remote control.
2. Image which is zoomed in can be moved by up/down/left/right cursor to move.
3. Image which is zoomed out cannot be moved.

8. OSD

In playing mode, short press OSD on remote control to show all information of present disc.

9. Number Buttons

In VCD mode, press 0-9 number button to input song. For example, you want to choose 13th song, press 10+ button, and then press 3 button once to play 13th song.

Note: This function can only be worked by the remote control.

10. Repeat Play

In playing mode, press AMS/RPT button on remote control, to startup following, repeat function. Single song repeat → Repeat play off.

Note:

- 1) When playing VCD disc, if PBC is on, no repeat function.
- 2) After unit is power off or mode is switched to other playing mode except VCD mode, if you switch back to VCD mode, repeat playing will be cancelled.

11. Randomly Play

In VCD mode, press LOC/RDM button on remote control, to instantly play each song. Press again to back to the normal play.

Note: When VCD disc, if PBC is on, RDM will not work.

12. Switch Track

In VCD mode, press AUDIO button on remote control to switch track as following sequence:

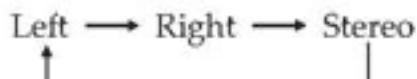

13. OPEN

Press OPEN button on panel to eject disc.

14. PBC (MENU) Play

In VCD mode, press this button then play the PBC and display will show whole menu in disc, work with number button to choose song. When you are playing either song of the PBC, and you want to stop to select another song, press the button to turn off.

Note:

- 1) This function can be worked by the control.
- 2) PBC is suitable for the SVCD and VCD 2.0 disc.
- 3) In PBC mode, you can not press number button only to choose song.

INSTRUCTIONS

15. VCD Program Playing

In VCD mode, you can set playing sequence of songs by program play function.

The program playing operation steps are as follows:

In VCD mode, press ST/PTOG button, display will show:

PROG	TC	TC	TC	TC			
1	__ : __	5	__ : __	9	__ : __	13	__ : __
2	__ : __	6	__ : __	10	__ : __	14	__ : __
3	__ : __	7	__ : __	11	__ : __	15	__ : __
4	__ : __	8	__ : __	12	__ : __	16	__ : __
		PLAY		DELETE			

Input the songs which you want to programmed by the number buttons on remote control. For example: Program the first song, input your desires song, for example, the fourth song, and press number button 4 on the remote control. Program the second song, press ▼ button move the cursor to 2____. Input your desired song, for example, the eighth song, press number button 8 on the remote control. Press ►|| button to program play. Back to the normal mode, press the ST/PROG button, then press ►|| button.

Note: This function can only be worked by the remote control.

CD/MP3 BASIC OPERATION (Look at Picture #4)

Slide in CD/MP3 disc, unit will play it automatically. If disc is in slot, press DVD touch button on main menu can to play.

1. Repeat Play

In CD/MP3 mode, press AMS/RPT button on remote control, to startup following, repeat CD disc: Single song repeat→ Repeat play off.

MP3 disc: Single song repeat→Directory repeat→ Repeat play off.

2. Fast Forward/Fast Rewind

Press SEEK + / SEEK - button on remote control, or ►► / ◀◀ touch button on display to speed forward or backward playing.

Note: Hold above button a bit longer to operate.

3. Previous/Next Song Play

In playing mode, press SEEK + / SEEK - on remote control, or ► / ◀ touch button on display to choose previous/next song.

4. Pause Play

In play mode, press ►|| button on remote control, or ►|| button on display to pause. Press again to go back to normal play.

5. Stop Play

In play mode:

1) Press ■/⏸ button on remote control to enter the pause mode, the position will be stored in unit. At that time, press ►|| button on remote control or touch button on display to resume playing at the stored position.

2) Press ■/⏸ button on remote control twice to enter into stop mode, here, press ►|| button on remote control or touch button on display, unit will play from the first song.

6. OSD

In playing mode, short press OSD on remote control to show all information of present disc.

7. Randomly Play

In CD mode, press LOC/RDM button on remote control, to instantly play each song. Press again to back to the normal play.

8. EQ Mode

1) This function can only be worked by remote control.

2) When playing CD/MP3, press the "ZOOM" button on the remote control, you can choose the sound mode.

3) When enter this function, press the button ▲/▼/◀/▶ to move the course to select sound mode which in the system menu, after your selection position will show red color to indicate the confirmation.

9. OPEN

Press OPEN button on panel to eject disc.

INSTRUCTIONS

10. CD Program Play

In CD mode, you can set the sequence of playing by the program function, the operation is as follows:

When CD is playing, press ST/PROG button, then the display shows:

PROG	TC	TC	TC	TC			
1	__ : __	5	__ : __	9	__ : __	13	__ : __
2	__ : __	6	__ : __	10	__ : __	14	__ : __
3	__ : __	7	__ : __	11	__ : __	15	__ : __
4	__ : __	8	__ : __	12	__ : __	16	__ : __
		PLAY		DELETE			

Input the number of the song you want to program by the remote control, program the first song, input your desired song, for example, the sixth song, and press number button 6 on the remote control. Program the second song, press ▼ button move the cursor to 2[_ _]. Input your desired song, for example, the ninth song, press number button 9 on the remote control. Press ► button to program play.

Back to the normal mode, press the ST/PROG button, then press ► button.

Note: This function can only be worked by the remote control.

11. MP3 Program Play

In MP3 mode, you can set the sequence of playing by the program function, the operation is as follows:

When MP3 is playing, press ST/PROG button, then the display shows:

PROG	TC	TC	TC	TC			
1	__ : __	5	__ : __	9	__ : __	13	__ : __
2	__ : __	6	__ : __	10	__ : __	14	__ : __
3	__ : __	7	__ : __	11	__ : __	15	__ : __
4	__ : __	8	__ : __	12	__ : __	16	__ : __
		PLAY		DELETE			

Then, input desired song by remote control.

For example: Program the first song, input 01, press ► button move the cursor to the second lattice, input desired song, for example the third song. Program the second song, press ► button, work with ▼ button, move the cursor to 2[_ _]. Input 01, press ► button move the cursor to the second lattice, input desired song, for example, the sixth song (press 6). Press ► button to program play.

Back to the normal mode, press the ST/PROG button and then press ► button.

Note: This function can only be worked by the remote control.

MP3/USB/SD OPERATION



Insert SD card or USB, MP3 disc; click the name of the song directly to select the song you want to broadcast. If there are pictures or video document in the disc or SD card, you can select the relative icon to broadcast.

1. Pause play

In playing mode, press ►|| button on remote control, or ►|| touch button on display to pause. Press again to back to normal play.

2. Previous / next song play

In playing mode, press SEEK + / SEEK - on remote control, or ►|/◀ touch button on display to choose previous/next song.

3. Speed forward / backward play

Press SEEK + / SEEK - button on remote control, or ►►/◀◀ touch button on display to speed forward or backward playing.

4. Repeatedly play

In CD mode, press AMS/RPT button on remote control, to startup following, repeat
Mp3 disc: Single song repeat → Directory repeat → Repeat play off.

INSTRUCTIONS

MUSIC SURROUNDINGS SETTING

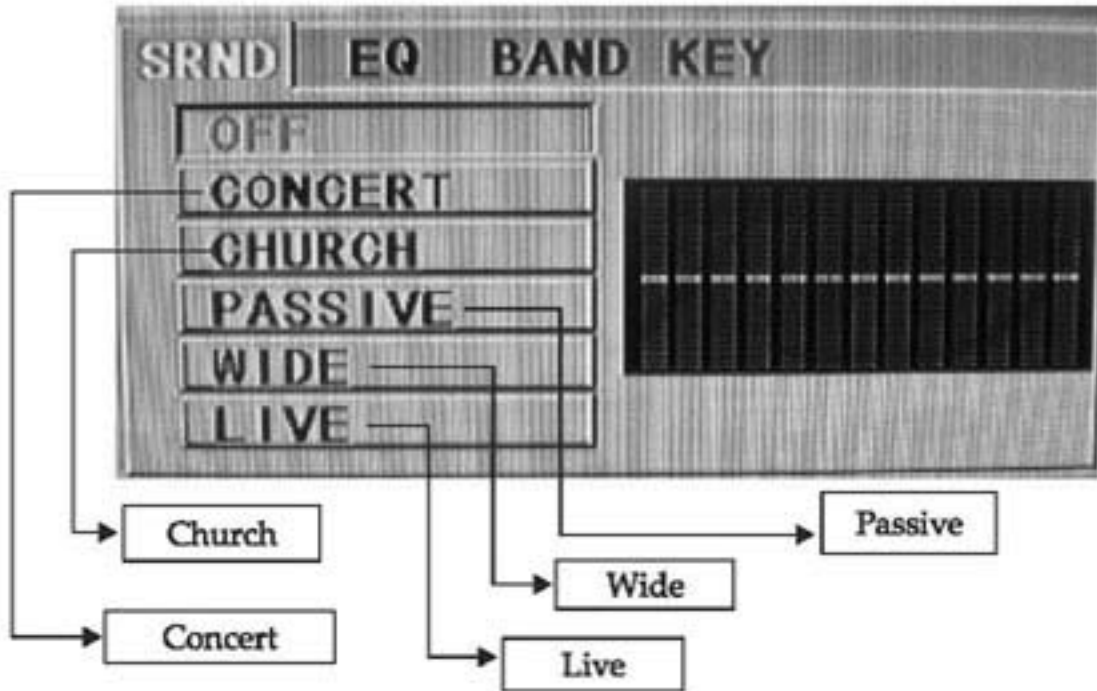

Note: This function only is used with the remote control in CD/MP3/USB/SD mode. Once you have one of these settings on. You will no longer have Bass & Treble adjustments until this feature is set to off.

EQ SETTING

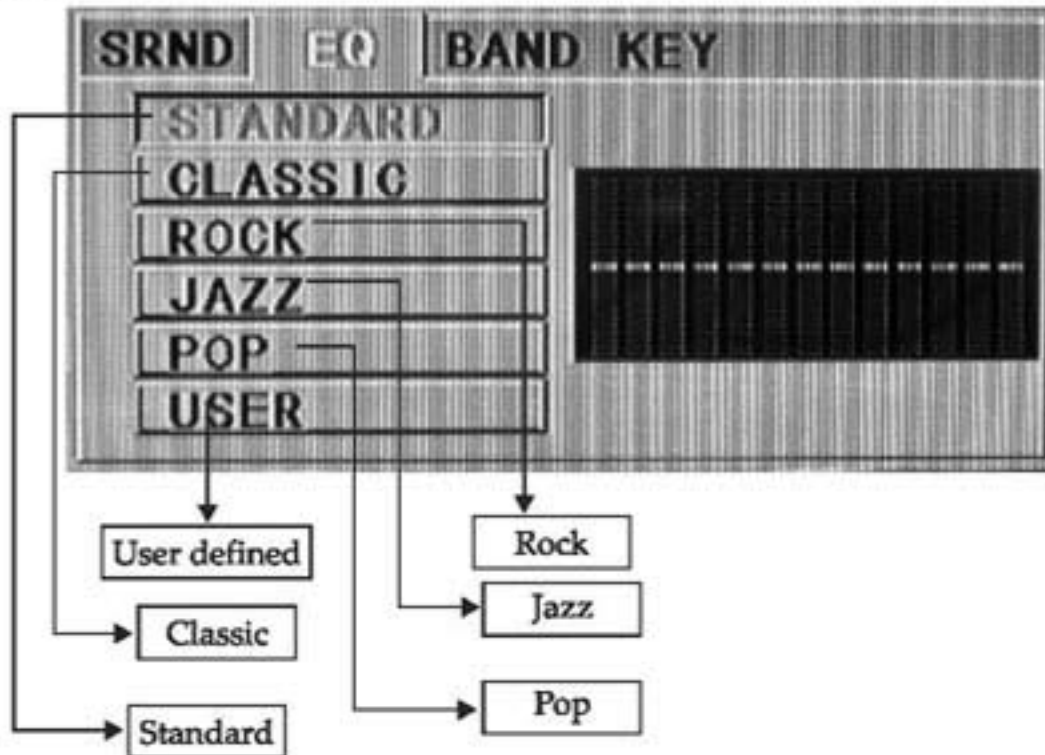

AUDIO FREQUENCY

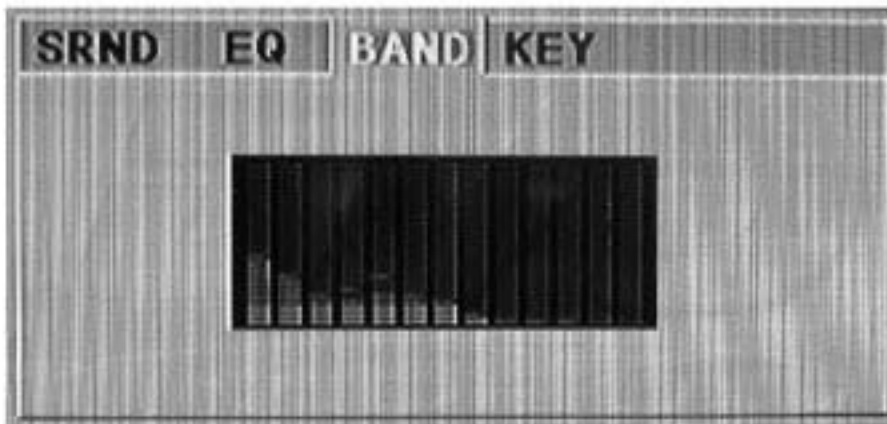

This function shows that the effect of standard audio output.

TONE

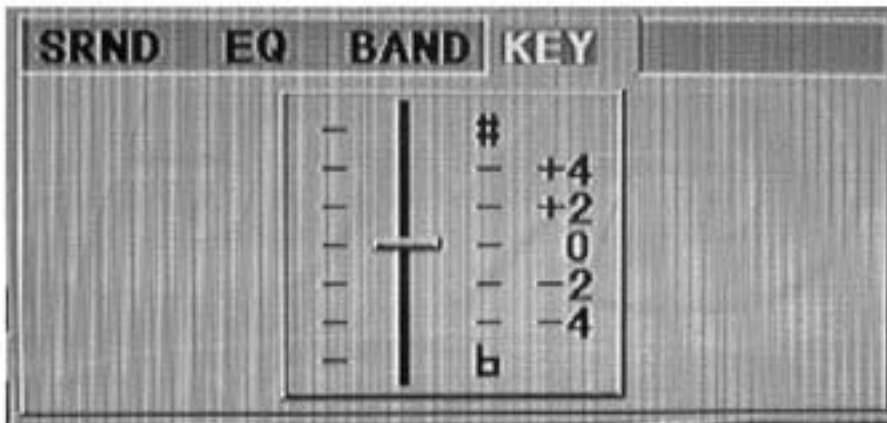

Note: You can change the timbre of the sound in DVD mode. We suggest keep it in the original place.

INSTRUCTIONS

OTHER PLAY MODE

AUX IN:

AUX IN OPERATION

- 1) Press "Source" button on remote control or touch "AUX" on the touch screen, to switch to AUX mode.
- 2) This will allow you to listen and or watch any source that you have plugged into this section of the radio.
- 3) This unit has 1 - Video RCA input & 1 pair of Audio RCA's for this feature.

CCD (Back-Up Camera)

- 1) If there is a back-up camera installed onto your car, you will need to connect it to the CCD video input.
- 2) When you are backing up the car there you will see this image  on your screen.
- 3) You can set CCD image according to your car's own position in general setting mode.

TROUBLE SHOOTING

PROBLEM	CAUSE	SOLUTION
Can not power on	Check whether power fuse blew or not	Change fuse same as the old one
	Some factor cause MPU wrong operation	Press RESET button on the panel by pen point, then, power on
After ignition switch off, setting information all lose	Wrong connection between ignition line ACC and Constant 12 Volt wire	Change the wiring around
Remote control no function	No enough power supply from battery	Change battery in remote control
Poor performance of radio station	Improper length of antenna, poor connection of antenna grounding	Check whether antenna is connected or not, or poor connection
Can not load disc	The disc will not go in all the way	Remove the 2 screws on top of the radio
Can not play disc	Disc is scratched	Change new disc
	Put wrong side of disc into unit	Slot in the disc with sign side up
	Lens has dirty	Clean lens by lens clean disc
Can not switch language/subtitle	There is only one language/subtitle in disc	If disc is not with multi-language/subtitle, it cannot switch language/subtitle
No image	Video line between unit and TV is not properly connected	Reconnect lines

INSTRUCTIONS

WIRING DIAGRAM

This player is equipped with ISO standard connector, please follow below instruction:

- Red - ACC ON (+12V)
- Yellow - 12 V Constant
- Black - Ground wire
- Blue - Power Antenna / Remote Amp Turn On
- Orange - Back-Up Camera Trigger (+)
- Grey/Grey black - Right front speaker (+/-)
- White/White black - Left front speaker (+/-)
- Purple/Purple black - Right rear speaker (+/-)
- Green/Green black - Left rear speaker (+/-)
- Pink - Parking Brake (-)

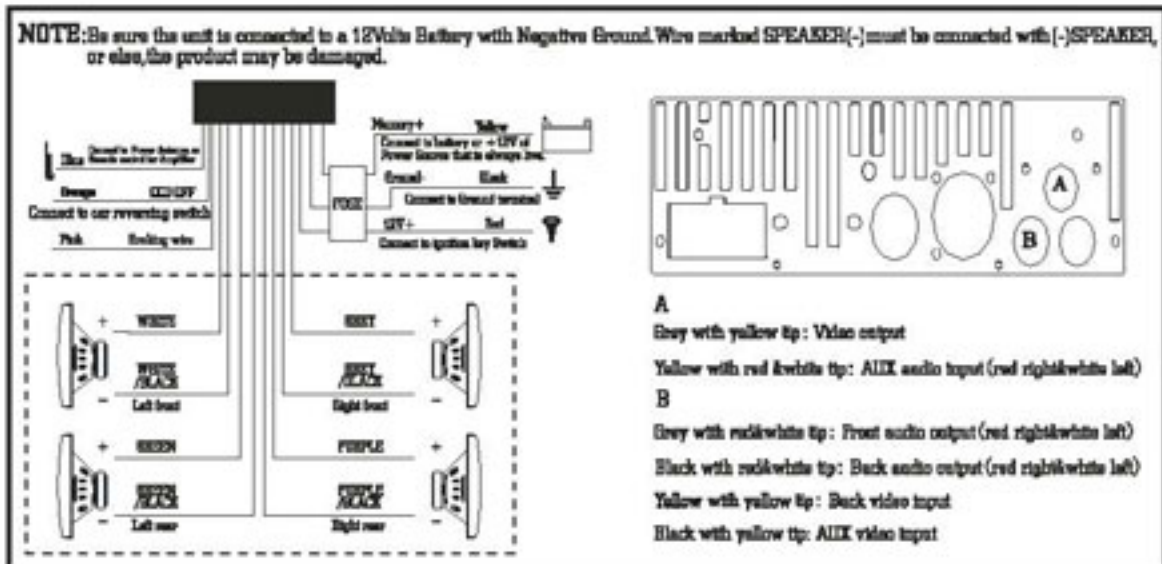

SPECIFICATIONS:

Power supply	DC 12V
Power range	10.8-16.0V DC
Max operate current	10A
Dimensions	180x178x50mm
Ground system	Negative ground

FM tuner

European frequency range	87.5-108MHz
USA frequency range	87.5-107.9MHz
Signal/Noise ratio	55dB
Stereo separation	30dB
Search station volt	20-30dBuv
Distortion rate	1.5%

AM tuner

European frequency range	522-1620KHz
USA frequency range	530-1710KHz
Limit noise sensitivity	32dB

DVD PLAYER

Signal/Noise ratio	70dB
Frequency response	20Hz-20KHz

PYLE®

www.pyleaudio.com

Free Manuals Download Website

<http://myh66.com>

<http://usermanuals.us>

<http://www.somanuals.com>

<http://www.4manuals.cc>

<http://www.manual-lib.com>

<http://www.404manual.com>

<http://www.luxmanual.com>

<http://aubethermostatmanual.com>

Golf course search by state

<http://golfingnear.com>

Email search by domain

<http://emailbydomain.com>

Auto manuals search

<http://auto.somanuals.com>

TV manuals search

<http://tv.somanuals.com>