



7 INCH WIDE TFT LCD MONITOR

INSTRUCTION MANUAL

PLVS7HM



Precautions

Please read this manual completely and carefully prior to attempting to install your new car video equipment. Install correctly, your new equipment will provide you with year of enjoyable and safe usage.

Installation of this equipment in any portion of a vehicle which impairs or distracts the driver is improper and dangerous. We assume no liability whatsoever for failure to follow the proper installation of this products.

1. Do not operate this equipment while driving-safe driving should always be your highest priority.
2. Do not install components in areas which are susceptible to rain, moisture direct sunlight, extreme heat or cold, excessive dust, dirt or humidity.
3. Immediately unplug the power cord and send the monitor to your local dealer or service center as soon as possible:
 - a) if there is smoke or any peculiar odor present during use
 - b) if there is damage to any of the internal components
4. To avoid damage to the monitor and risk of electronic shock, do not permit any of this equipment to become damp or wet from water or liquid. If this does occur, immediately unplug the power cord and send the monitor to your local dealer or service center as soon as possible.
5. Do not attempt to repair, open or disassemble any of the components. Dangerous high voltages are present which may result in electric shock.
6. Use only a power source with 12 volts DC (negative ground).
7. Do not place objects on or suspend objects from the power cord, as this may damage the cord.
8. Do not twist or place the power cord near any source of heat in the vehicle.
9. Do not attempt to repair a damaged, broken or faulty power cord. Replace it with a new one immediately.
10. Avoid dropping any metal objects or inflammable items into the monitor ventilation slots.
11. After the monitor is installed, do not arbitrarily pull it down or strike it. This may loosen the mounting screws and cause it fall down.

Control and layout for the monitor

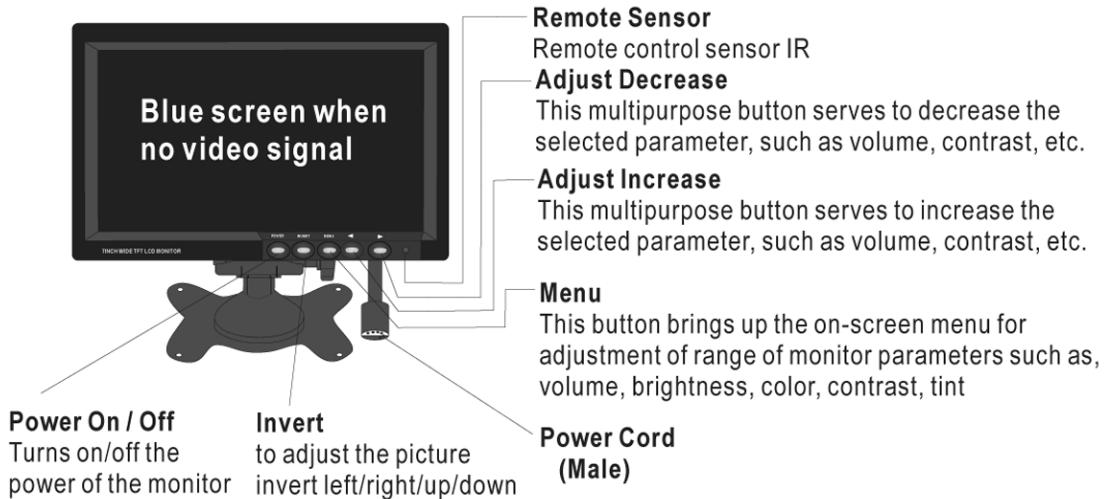

Notice: some functions are work by remote control.

Control and layout for the remote control

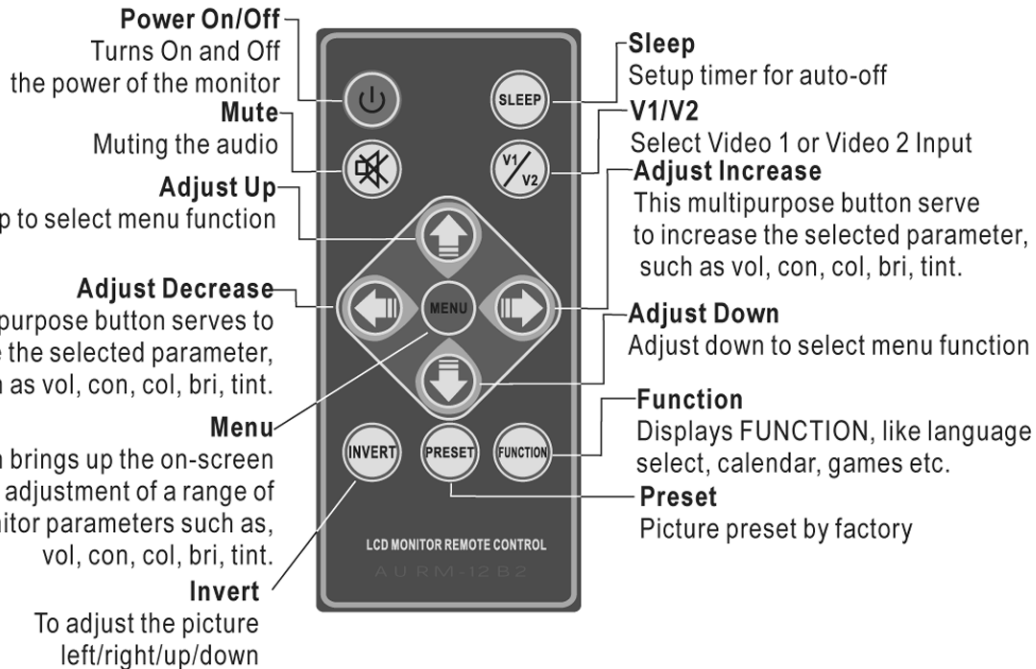

Notice: If the monitor does not have the function, the button would not be work.

Function

Press FUNCTION button on the remote or press manual button twice from the monitor to call out the function menu.

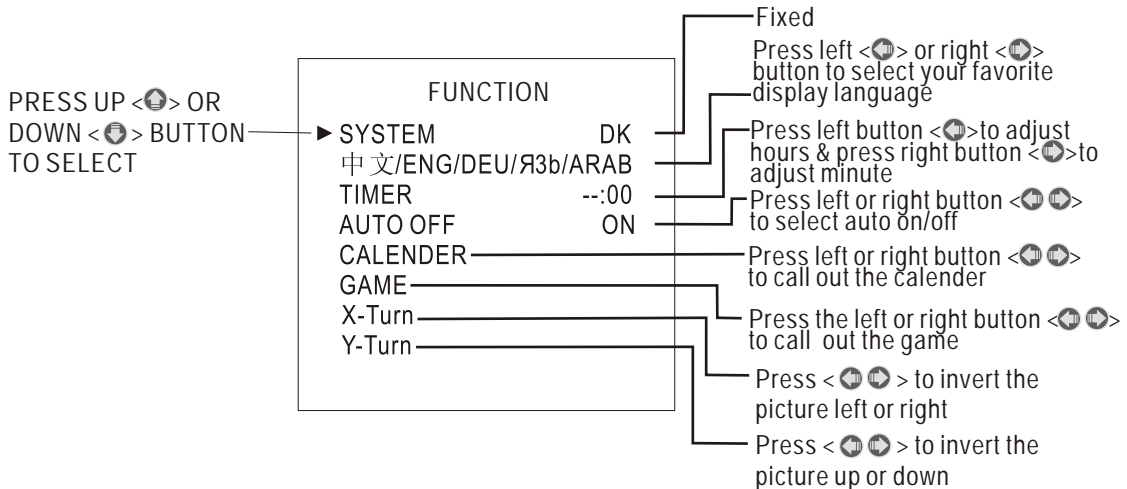

Games

Press <🎮🎮> to enter the games.

Start --Menu Button <🎮>

Move --Down Button <⬇️>

Roll --Up Button <⬆️>

Exit --Mute Button <🔇>

Level --AV Button <🔊>

Pause --Menu Button <🎮>

Move Left --Volume Button <🔊>

Move Right --Volume Button <🔇>

RUSSIA SHAPE

PIC START

CH- MOVE

CH+ ROLL

MUTE EXIT

AV SELECT LEVEL

-VOL+ MOVE

Calendar

Press FUNCTION <🔧> to call out the function menu,
then Press <📅> to select CALENDAR and
press left or right to <👈👉> to call out the CALENDAR

2004		AUG				
SU	MO	TU	WE	TH	FR	SA
1	2	3	4	5	6	7
8	9	10	11	12	13	14
15	16	17	18	19	20	21
22	23	24	25	26	27	28
29	30	31				

BEST WISH FOR YOU

Adjust increase of year, press <⬆️> button

Adjust decrease of year, press <⬇️> button

Adjust increase of month, press <👉> button

Adjust decrease of month, press <👈> button

Installation

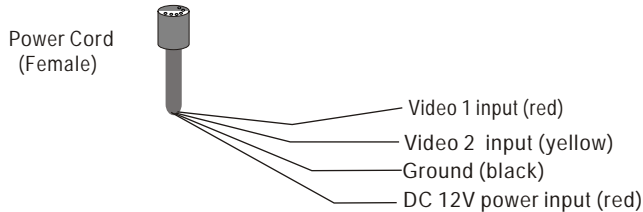

Remote Control replacing batteries

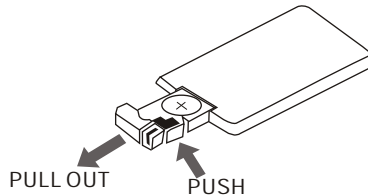

- 1) Always use new batteries when replacing the old set.
- 2) Do not attempt to charge, short-circuit, disassemble, heat or burn used batteries.
- 3) Battery replacement is necessary when remote control acts sporadically or stops operating.
- 4) Do not drop, apply shock or step on the remote control
- 5) Do not spill water on the remote control
- 6) Do not place objects between the remote control and remote sensor.
- 7) Do not use remote controls for other equipments at the same time.
- 8) If the MONITOR does not operate even when operating the remote control from a close range, it is time to replace the batteries (use CR-2025), refer to the label on back of the basic control.

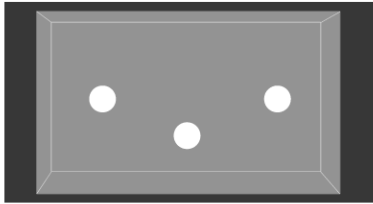

Sun Visor Housing

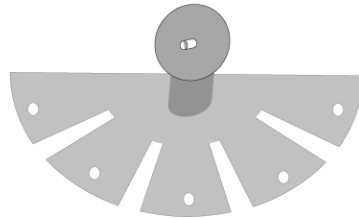

Mounting Stand

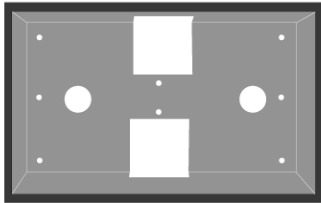

Headrest Housing

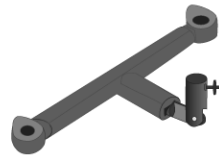

Headrest Bracket



Remote Control



Extension Min Din Cable

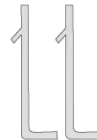

Key- for removing the monitor from headrest shroud

Unscrew it and take away the back cover before install to headrest housing or sun-visor housing

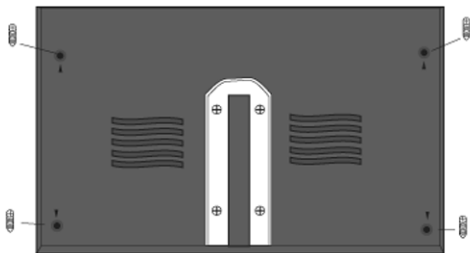

CAUTION: make sure the screw are not long enough to go through the headrest!
If you have any doubts about this type of installation, please consult your local mobile electronics retailer. Cutting and make holes in the headrest will cause damage which is expensive to repair.

Step of install headrest housing

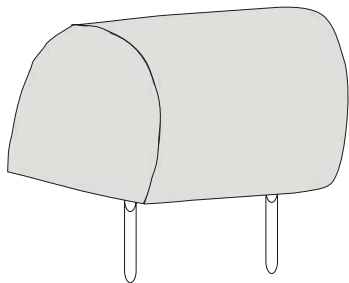

Setup work
remove the headrest and set it in an uncluttered work area. Take the appropriate precautions to ensure that it is not damaged during the installation.

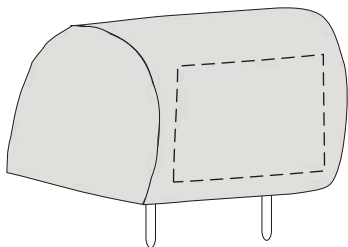

Measurements

Push on the headrest with your fingers to make sure there are no obstructions that would hinder the installation. Use the paper template to mark the area to be cut.

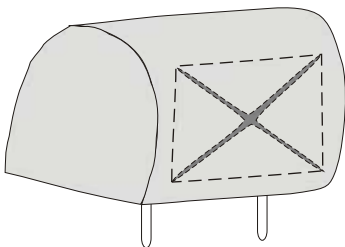

Cut the headrest

using an adjustable-depth blade, start your cut 1/4 inch inside one corner and cut diagonally across, stopping 1/4 inch in from the other corner. Repeat the procedure for the other two corners.

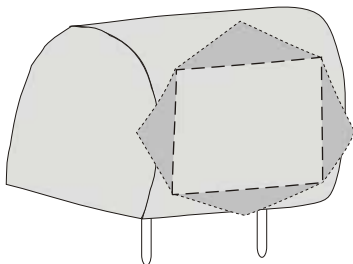

Remove foam & obstructions

Carefully peel back the material. Set the adjustable blade to one inch depth and cut around the edges of the hole, staying 1/4 inch inside the edge. Pull up one corner of the foam and use the blade to cut underneath. Remove small section at a time, using the pull up and cut method for uniform depth. Use a dremel or other appropriate tool to remove other obstructions. Insert the monitor to measure the fit and make adjustments if necessary

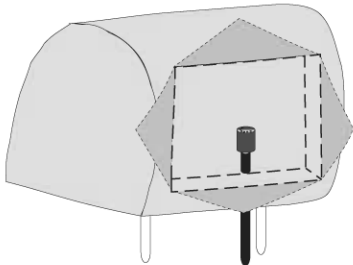

Route the cable through the headrest

Run the supplied cable through the opening and out to the bottom of the headrest. If possible, conceal the wires using a shaft covering. Connect the power, ground and video leads to test the MONITOR.

Before connecting the monitor, pull the connecting cable assembly through the headrest housing as shown in diagram. Place headrest housing into the opening and secure with correct fasteners.

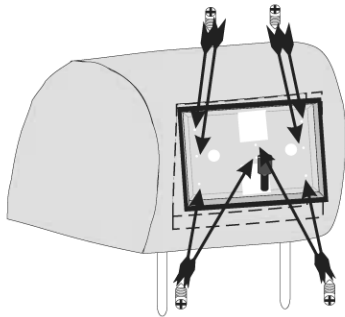

Install the headrest housing

Pull the connecting cable through the center of the housing as shown in diagram, and secure with correct fasteners

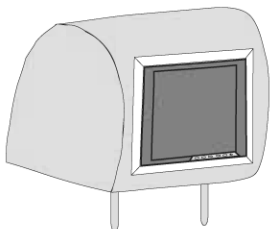

Insert the monitor

Push to insert the monitor to the headrest housing.

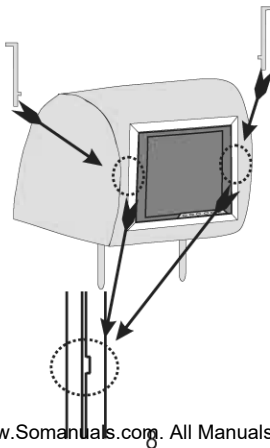

Removal

Insert the release key between the monitor and headrest housing gap and this will remove the monitor from headrest housing.

Step of install sun-visor housing



Setup work

remove the visor and set it in an uncluttered work area. Take the appropriate precautions to ensure that it is not damaged during the installation.

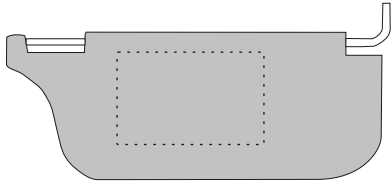

Measurements

Push on the headrest with your fingers to make sure there are no obstructions that would hinder the installation. Use the paper template to mark the area to be cut.

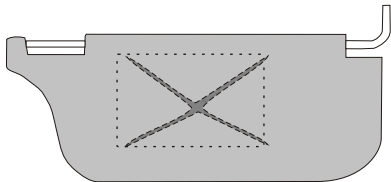

Cut the visor

using an adjustable-depth blade, start your cut 1/4 inch inside one corner and cut diagonally across, stopping 1/4 inch in from the other corner. Repeat the procedure for the other two corners.

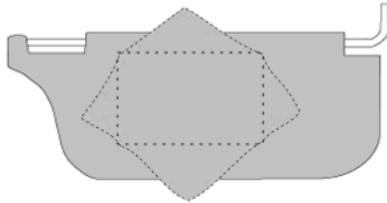

Remove foam & obstructions
Carefully peel back the material. Set the adjustable blade to one inch depth and cut around the edges of the hole, staying 1/4 inch inside the edge. Pull up one corner of the foam and use the blade to cut underneath. Remove small section at a time, using the pull up and cut method for uniform depth. Use a dremel or other appropriate tool to remove other obstructions. Insert the monitor to measure the fit and make adjustment if necessary

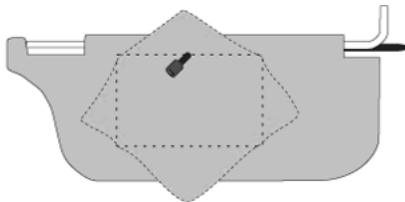

Route the cable through the visor
Run the supplied cable through the opening and out the top of the visor. If possible, conceal the wires using a shaft covering. Connect the power, ground and video leads to test the MONITOR.
Before connecting the monitor, pull the connecting cable assembly through the visor housing as shown in diagram. Place visor housing into the opening and secure with correct fasteners.

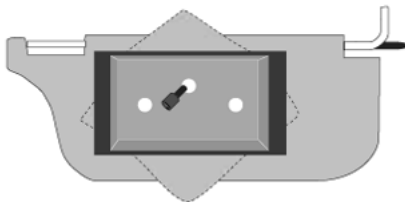

Install the sun-visor housing
Pull the connecting cable through the center of the housing as shown in diagram, and secure with correct fasteners



Insert the monitor

Push to insert the monitor to the sun-visor housing

Operating your system in a safe and legal manner

When operating a motor vehicle, it should always be your highest priority to maintain safe driving habits.

It is illegal in many areas of the countries to drive with TV or MONITOR turned on, when it is visible to the driver. Please check your local and state laws governing the use of MOBILE ENTERTAINMENT SYSTEM in your area.

Installation of headrest bracket

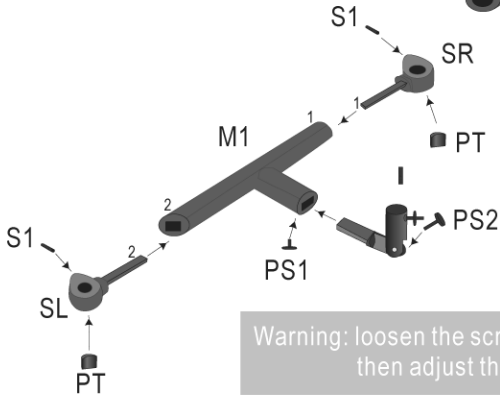
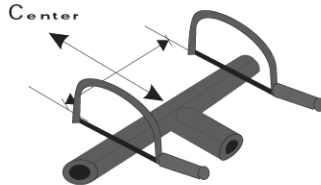
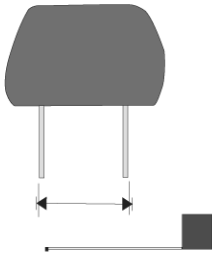

Warning: loosen the screw (PS2) then adjust the angle

M1		X1
SL		X1
SR		X1
SP1		X1
SP2		X1
SP3		X1
PS2		X1
PS1		X1
H1		X1

S2		use K2 to tie the screw	S1		S2		K1		K2		PT	
SP2			4.88mm	5.95mm	2.48mm	2.95mm						
		Diagram 1										
SP3			X2	X1	X1	X1	X2					
		Diagram 2										

Technical parameters

LCD Drive Method: TFT Active Matrix

Display Size: **7 Inch Wide Screen (Diagonal)**

Aspect: 16:9

Display Format: 480 x RGB x 234

Number of Pixels: 1440 x 234

Video System Input: NTSC/PAL Auto-select

Back Light: High Brightness Type U Shaped CCFT

Power Source: DC12V

Current Consumption: 8W

Dimension (H x W x D): 113 x 182 x 25 (mm) Stand Style

Dimension (H x W x D): 128 x 195 x 24 (mm) Headrest Style

Dimension (H x W x D): 127 x 236 x 25 (mm) Sun Visor Style

Free Manuals Download Website

<http://myh66.com>

<http://usermanuals.us>

<http://www.somanuals.com>

<http://www.4manuals.cc>

<http://www.manual-lib.com>

<http://www.404manual.com>

<http://www.luxmanual.com>

<http://aubethermostatmanual.com>

Golf course search by state

<http://golfingnear.com>

Email search by domain

<http://emailbydomain.com>

Auto manuals search

<http://auto.somanuals.com>

TV manuals search

<http://tv.somanuals.com>