

# PYLE®

## OWNER'S MANUAL

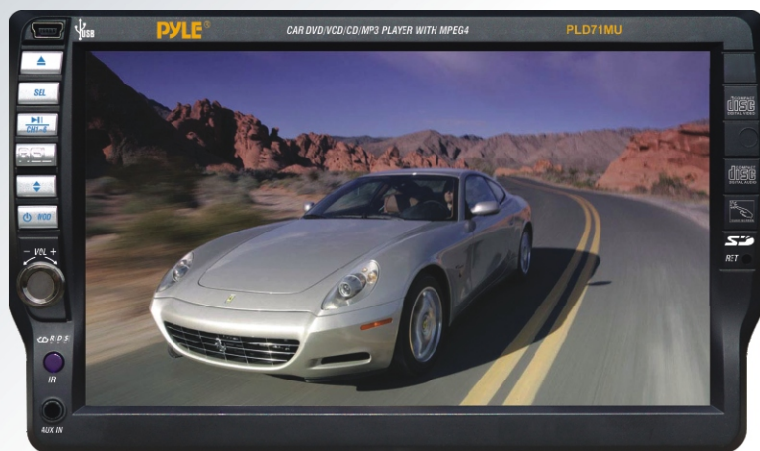

## PLD71MU

- **Motorized Slide Down and Detachable Panel**
- **7-Inch Wide TFT Touch Screen Monitor**
- **Front panel USB port and AUX input**
- **Car DVD/VCD/MP4/CD/MP3 Player**
- **Built in AM/FM Tuner and RDS**
- **SD Card Slot in the panel**

# Contents

---

|                                     |           |                                    |           |
|-------------------------------------|-----------|------------------------------------|-----------|
| <b>Precautions</b> .....            | <b>2</b>  | Selecting Subtitles .....          | 27        |
| <b>Safety Information</b> .....     | <b>3</b>  | Selecting multi-angle views .....  | 27        |
| <b>Disc Notes</b> .....             | <b>4</b>  | Title menu function .....          | 27        |
| <b>Installation</b> .....           | <b>5</b>  | <b>Setup</b> .....                 | <b>28</b> |
| Detaching the control panel .....   | 7         | General Setup .....                | 28        |
| Changing the control panel .....    | 8         | Speaker Setup .....                | 30        |
| <b>Electric Connection</b> .....    | <b>9</b>  | Dolby Digital Setup .....          | 30        |
| <b>Remote Control</b> .....         | <b>10</b> | Preferences Setup .....            | 31        |
| <b>Control Panel</b> .....          | <b>13</b> | Defaults Table .....               | 32        |
| Touch Panel.....                    | 13        | <b>Other Main Operations</b> ..... | <b>33</b> |
| Unit Keys .....                     | 14        | USB Operations .....               | <b>33</b> |
| <b>Basic Operations</b> .....       | <b>16</b> | SD/MMC Card Operations .....       | 34        |
| TFT Monitor Adjustment .....        | 17        | MP3/WMA/JPEG Play .....            | 35        |
| Rear View Camera .....              | 17        | MPEG4 Play .....                   | 35        |
| Audio Quality Adjustments .....     | 17        | <b>Specifications</b> .....        | <b>36</b> |
| Setting Audio Mode .....            | 18        | <b>Trouble Shooting</b> .....      | <b>37</b> |
| Reset Factory Settings .....        | 18        |                                    |           |
| Alternate Audio/Video Source .....  | 18        |                                    |           |
| <b>Radio Operations</b> .....       | <b>19</b> |                                    |           |
| Listening to the radio .....        | 19        |                                    |           |
| Storing stations in memory .....    | 19        |                                    |           |
| Listening to a preset station ..... | 20        |                                    |           |
| RDS Function .....                  | 20        |                                    |           |
| <b>DISC Operations</b> .....        | <b>22</b> |                                    |           |
| Basic Operations .....              | 22        |                                    |           |
| Select Playback Mode .....          | 24        |                                    |           |
| AUX Operation .....                 | 25        |                                    |           |
| On-Screen Disc Operations .....     | 26        |                                    |           |
| <b>DISC Special Functions</b> ..... | <b>27</b> |                                    |           |
| Selecting audio languages .....     | 27        |                                    |           |

# Precautions

---

## **THANK YOU FOR PURCHASING THIS CAR DVD PLAYER .**

Before operating the unit, read this manual thoroughly and keep it handy for future reference .

To avoid injury or accident , read the following precautions before installing and operating the unit .

### **ON INSTALLATION**

- DO NOT install any receiver in locations where;
  - it may obstruct the steering wheel and gearshift lever operations, as this may result in a traffic accident.
  - it may obstruct the operation of safety devices such as air bags, as this may result in a fatal accident.
  - it may obstruct visibility.
- DO NOT operate any receiver while manipulating the steering wheel, as this may result in a traffic accident.
- The driver must not watch the monitor while driving.
- IF THE DRIVER watches the monitor while driving, it may lead to carelessness and cause an accident.
- IF YOU NEED to operate the receive while driving, be sure to look ahead carefully or you may be involved in a traffic accident.
- IF THE PARKING BRAKE is not engaged. “ ParkingBrake ” flashes on the monitor, and no playback picture will be shown.
  - This warning appears only when the parking brake wire is connected to the parking brake system built in the car ( refer to the electric connection)

### **ABOUT THE LIQUID CRYSTAL DISPLAY (LCD) PANEL**

Do not press on the LCD panel on the unit as doing so can distort the picture or cause a malfunction . The picture may become unclear , or the LCD panel may be damaged .

### **NOTES ON CLEANING**

-Clean the LCD panel with a slightly damp soft cloth.

-Do not use solvents such as benzine, thinner, commercially available cleaners or antistatic spray .

-Do not use alcohol to clean the screen .

If your car was parked in a cold or hot place, the picture may not be clear . The monitor is not damaged . The picture will become clear the temperature in your car becomes normal .

# Safety Information

---

## **CAUTION:**

THIS DVD PLAYER IS A CLASS I LASER PRODUCT. HOWEVER THIS DVD PLAYER USES A VISIBLE/INVISIBLE LASER BEAM WHICH COULD CAUSE . HAZARDOUS RADIATION EXPOSURE IF DIRECTED. BE SURE TO OPERATE THE DVD PLAYER CORRECTLY AS INSTRUCTED.

USE OF CONTROLS OR ADJUSTMENTS OR PERFORMANCE OF PROCEDURES OTHER THAN THOSE SPECIFIED HEREIN MAY RESULT IN HAZARDOUS RADIATION EXPOSURE. DO NOT OPEN COVERS AND DO NOT REPAIR YOURSELF. REFER SERVICING TO QUALIFIED PERSONNEL.

## **WARNING:**

TO REDUCE THE RISK OF FIRE OR ELECTRIC SHOCK, DO NOT EXPOSE THIS EQUIPMENT TO RAIN OR MOISTURE.

TO REDUCE THE RISK OF FIRE OR ELECTRIC SHOCK, AND ANNOYING INTERFERENCE, USE ONLY THE RECOMMENDED ACCESSORIES.

THIS DEVICE IS INTENDED FOR CONTINUOUS OPERATION.

## **COPYRIGHT PROTECTION**





This product incorporates copyright protection technology that is protected by method claims of certain U.S. Patents and other intellectual property rights owned by Macrovision Corporation and other rights owners. Use of this copyright protection technology must be authorized by Macro vision Corporation, and is intended for home and other limited viewing uses only unless otherwise authorized by Macrovision Corporation. Reverse engineering or disassembly is prohibited.

## **REGION MANAGEMENT INFORMATION:**

This DVD Player is designed and manufactured to respond to the Region Management Information that is recorded on a DVD disc. If the Region number described on the DVD disc does not correspond to the Region number of this DVD Player, this DVD Player cannot play this disc.

# Disc Notes

## Disc formats supported by this player

|     |   |                                    |
|-----|---|------------------------------------|
| DVD |  | Audio and Video<br>Disc size 12 cm |
| VCD |  | Audio and Video<br>Disc size 12 cm |
| CD  |  | Audio<br>Disc size 12 cm           |
| MP3 |  | Audio<br>Disc size 12 cm           |

## Discs which cannot be played with this player

- DVD-RAM
- CDV
- CDG

## Handling and Cleaning

- Dirt, dust, scratches and warping disc will cause misoperation.
- Do not place stickers or make scratches on discs.
- Do not warp discs.
- A disc should always be kept in its case when not in use to prevent from damaging.
- Do not place discs in the following places:
  1. Direct sunlight
  2. Dirty, dusty and damp areas
  3. Near car heaters
  4. On the seats or dashboard

## Disc Cleaning

Use a dry soft cloth to wipe the surface. If the disc is quite dirty, use a soft cloth slightly moistured with isopropyl (rubbing) alcohol. Never use solvents such as benzine, thinner or conventional record cleaners as they may mar the surface of the disc.

### Note:

A disc may become somewhat scratched (although not enough to make it

unusable) depending on your handle it and conditions in the usage environment. Note these scratches are not an indication of any problem with the player.

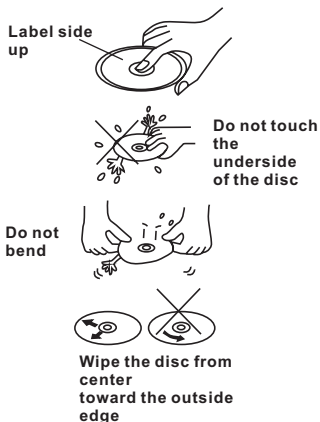

## Preparing New Discs with Rough Spots

A new disc may have rough edges on its inside and outside edges. If a disc with rough edges is used, the proper setting will not be performed and the player will not play the disc. Therefore, remove the rough edges in advance by using a ball point pen or pencil as shown on the right. To remove the rough edges, press the side of the pen or pencil against the inside and outside edges of the disc.

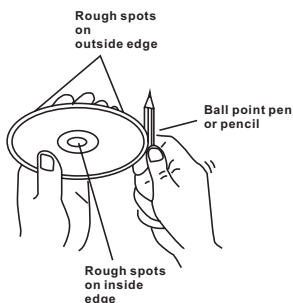

# Installation

---

## NOTES:

1. Choose the mounting location where the unit will not interfere with the normal driving function of the driver.
2. Before finally installing the unit, connect the wiring temporarily and make sure it is all connected up properly and the unit and the system work properly.
3. Use only the parts included with the unit to ensure proper installation. The use of unauthorized parts can cause malfunctions.
4. Consult with your nearest dealer if installation requires the drilling of holes or other modifications of the vehicle.
5. Install the unit where it does not get in the driver's way and cannot injure the passenger if there is a sudden stop, like an emergency stop.
6. Avoid installing the unit where it would be subject to high temperature, such as from direct sunlight, or from hot air, from the heater, or where it would be subject to dust, dirt or excessive vibration.
7. If installation angle exceeds  $30^\circ$  from horizontal, the unit might not give its optimum performance.

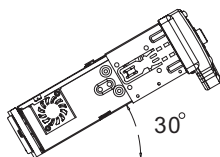

## DIN FRONT/REAR-MOUNT

This unit can be properly installed either from "Front"(conventional DIN Front-mount) or "Rear"(DIN Rear-mount installation, utilizing threaded screw holes at the sides of the unit chassis). For details, refer to the following illustrated installation methods.

## Revoving the unit

1

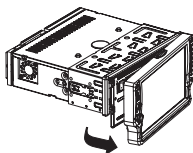

1. Press the **REL** button to release the front panel .

2

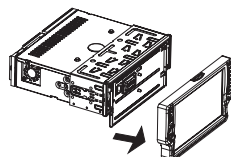

2. Remove the control panel .

# Installation

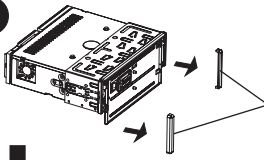
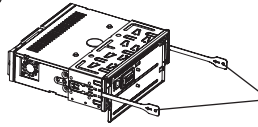
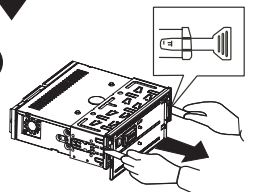
- 3**  3. Remove the PLASTIC COVER of the both sides away
- 4**  4. Insert the two KEY PLAT into the grooves at both sides of the unit as shown in figure until they click .
- 5**  5. Pulling the levers makes it possible to remove the unit from the dashboard .

## Installation the unit

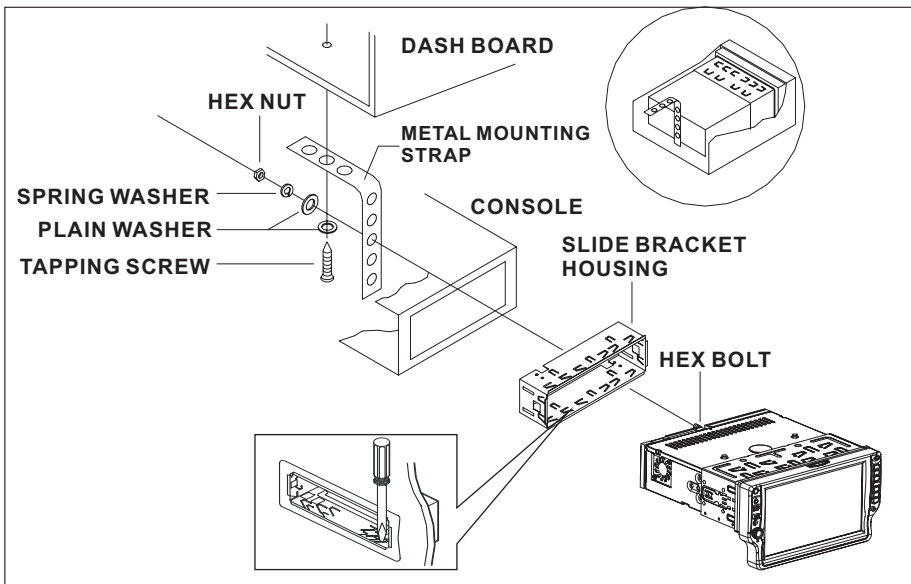

# Installation

## How To Remove And Install The Front Panel

When detaching or attaching the control panel, be careful not to damage the connectors on the back of the control panel and on the panel holder.

### Detaching The Front Panel

Before detaching the control panel, be sure to turn off the power.

1). Press the "REL" release button and the left hand side of front panel will release.

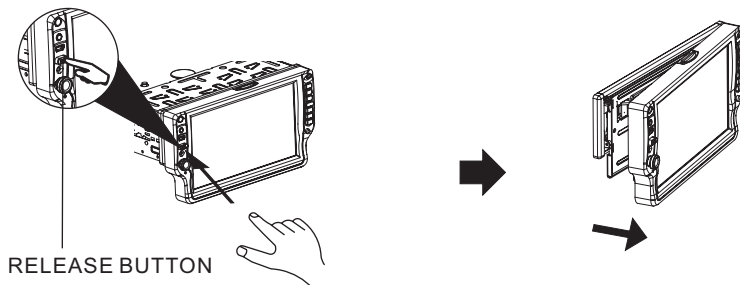

2). Pull-off the front panel and keep the front panel into the case .

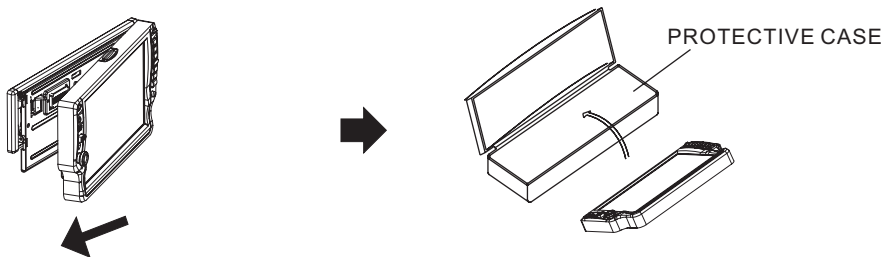

### Attaching The Front Panel

1). First insert the right hand side of the front panel into the hollow of the unit .

(NOTE : the "bulge" point on the panel must be attached into the hollow of the unit .)

2). Gently push the left hand side of the front panel until you feel a "Click" .

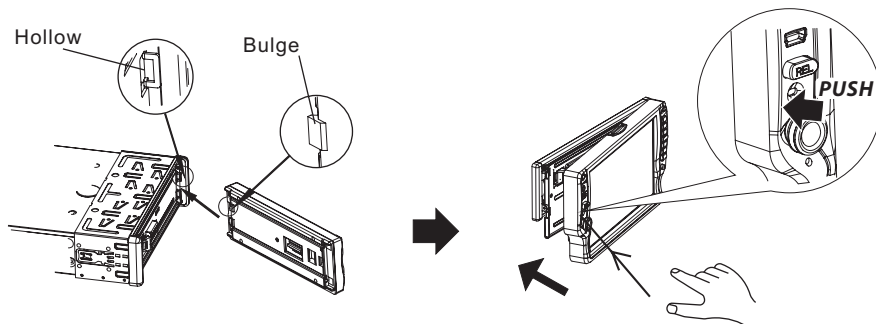





# Panel Angle Adjustment

---

## CHANGING THE CONTROL PANEL ANGLE

When you want to change the viewing angle of the operating unit to play, you can touch the  section on touch screen (or press the  button on the front panel) repeatedly to select the desired angle as follows:

**ANGLE 1 - ANGLE 2 - ANGLE 3 - ANGLE 4 - ANGLE 1 .**

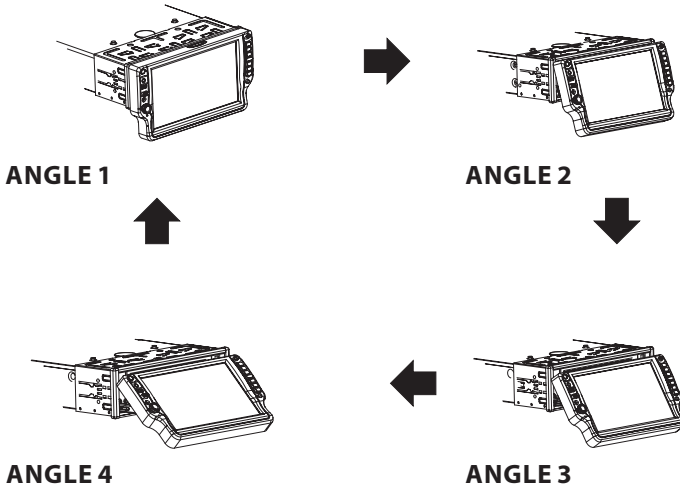

### Caution:

Do not insert your finger behind the control panel.

# Electric Connection

## WIRING CONNECTION

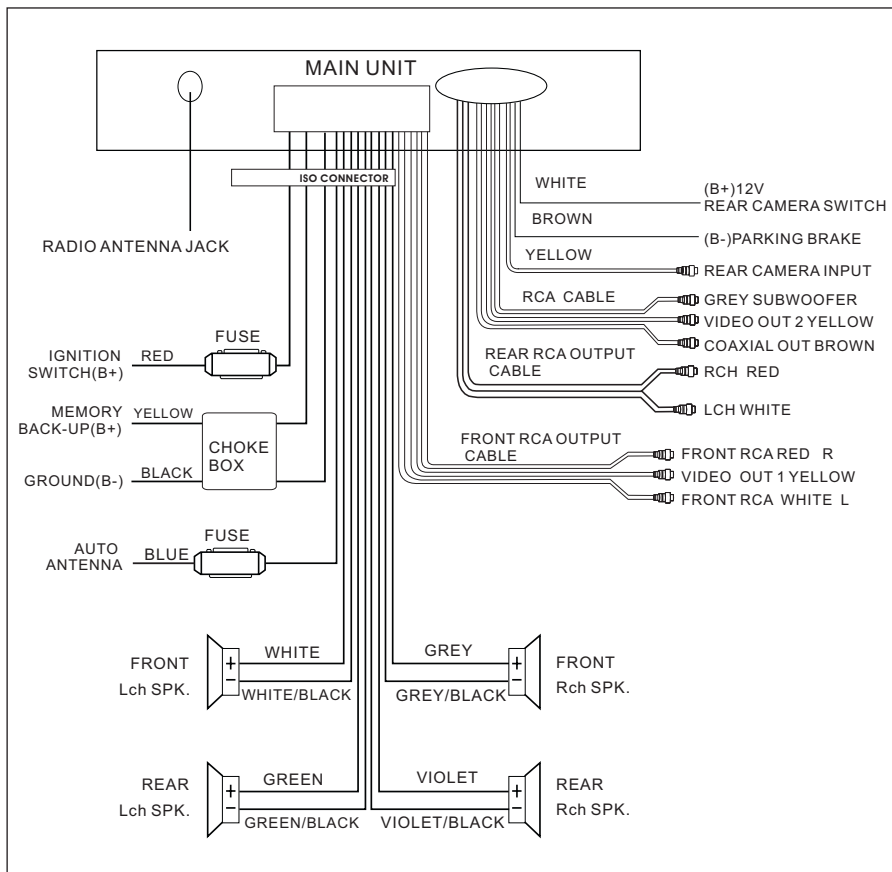

### Note:

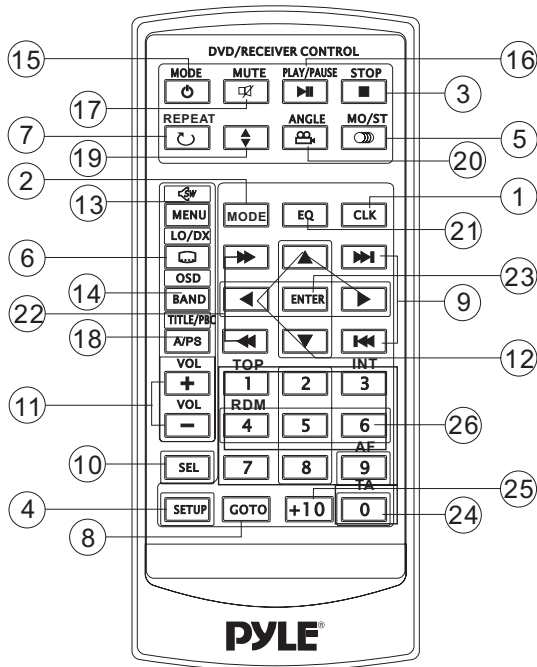

the earth connection cable (parking brake B-) must be connected in order for DVD pictures to be played back to the monitor. If the cable has not been correctly connected, the message "PARKING BRAKE" appears on the monitor.

# Remote Control



| Ref # | Button                 | Function  |
|-------|------------------------|---|
| 1     | CLOCK                  | Press it briefly to view the clock time , Press again to return to normal display mode . Press longer to set the time .   |
| 2     | MODE                   | Press repeatedly to cycle through the various modes: RADIO > DISC > AUX IN.   |
| 3     | STOP                   | Press once to pause playback. Press PLAY/PAUSE to resume playback. Please note: if you press STOP twice, playback will start at the beginning of the disc.  |
| 4     | SETUP                  | Press this button to open the SETUP menu.   |
| 5     | MO/ST (AUDIO)          | In Radio mode, press this button to change between Mono and Stereo reception modes (when a station is weak, sometimes switching to Mono will improve sound quality). In Disc Playback mode, pressing this button opens the AUDIO setup menu for making changes to the way the soundtrack is reproduced. |
| 6     | SUBTITLE LOCAL/DISTANT | In DVD Disc Playback mode, pressing this button will allow you to change the subtitle language on discs which have this as an option. In Radio mode, press this button to change the radio reception sensitivity in stations are near or far.   |
| 7     | REPEAT                 | Pressing this button will open a menu presenting you with the playback repeat options available for that kind of disc.  |

# Remote Control

| Ref # | Button  | Function   |
|-------|---|--|
| 8     | GOTO  | Press it button to begin playback at a moment in the program you designate. Use number buttons to enter the data that is needed.   |
| 9     | ▶▶ / ◀◀   | Press these buttons to skip ahead or back one track. (Note: In DVD mode, press continually the ◀◀ twice to skip back one)  |
| 10    | SEL   | Press this button repeatedly to cycle through the various audio and video adjustments you can make: Volume, Bass, Treble, Balance, Fader, Color, Brightness, Contrast and Tint.  |
| 11    | VOL+/-  | Use these controls to adjust the volume level.   |
| 12    | ◀ / ▶ / ▲ / ▼   | Press to navigate the various menus present in the product.  |
| 13    | Menu<br>SubWoofers<br>(  ) | Press this button briefly to display the root level directory of a DVD disc. Press and hold this button to turn on or off the SUBWOOFER output.  |
| 14    | BAND<br>(OSD)   | In Radio mode, press this button repeatedly to switch between the five radio bands: FM1 > FM2 > FM3 > AM1 > AM2.<br>In Disc Playback modes, Press this button to see information about the disc currently in play.   |
| 15    | <br>(POWER)                | Press this button to turn the unit ON , press and hold to turn the unit OFF.   |
| 16    | PLAY/<br>PAUSE  | In Disc Playback mode, press to pause playback. Press again to start where playback stopped.   |
| 17    | MUTE  | Press this button to turn off the audio. Press again to restore the sound to its prior volume level.   |
| 18    | TITLE/<br>PBC(A/P)  | When playing a DVD, pressing this button will open the TITLE menu which is recorded on the DVD. When playing a VCD disc, press this button to create a PBC (Playback Control) menu for the disc to assist in making playback selections. In Radio mode, press and hold this button to start the Auto-Program mode, during which the tuner will scan for all strong stations and assign them to the radio preset buttons. |
| 19    |                          | Press this button to adjust the screen viewing angle (see page 8).   |
| 20    | ANGLE   | For DVD discs which have alternate viewing angles encoded, when you see the "angle mark" symbol advising you that these angles are available, press this button to see them.   |
| 21    | EQ  | Press repeatedly to cycle through the different equalizer curve presets you may wish to use for enhanced listening.  |
| 22    | ▶▶ / ◀◀   | In Disc Playback mode, press for fast forward/reverse playback.  |
| 23    | ENTER   | This button is used to confirm selections and settings within many of the menus in the OSD system.   |

# Remote Control

| Ref # | Button | Function   |
|-------|--------|--|
| 24    | 0-9    | These buttons are used for numeric entry in many different menus. In addition, in Radio Mode (when RDS is engaged), 0 serves as the TA button and 9 serves as the AF button. |
| 25    | +10    | This button is used with the other number buttons for use with two-digit number entries.   |
| 26    | 1-6    | Six numbered preset buttons store and recall stations for each band.   |

## Preparing the Remote Control

### Inserting the Battery

1. First push to inside as the direction indicated by the arrow (See ①) And then Remove the battery holder as the direction indicated by the arrow (See ②).
2. Replace the battery Set a new battery property with (+)side up as illustrated (See ③).
3. Insert the battery holder. Push in the holder to the original position(See ④).

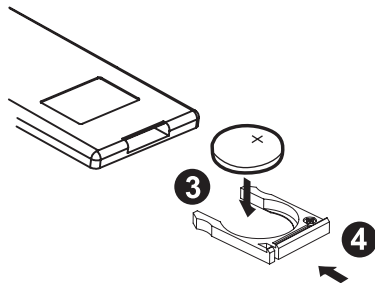
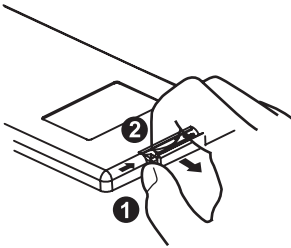

### Using the Remote Control

Face the remote control towards the player front face IR mark (remote control signal receiver).

Operation angle: About  $\pm 30$  degree in each the direction of the front of the IR mark.

### Note :

The lithium cell in the battery compartment of remote control has been secured for transport with a foil . Before initial use please remove this foil so that the remote control is ready for operation .

# Control Panel

## Key Functions

### Touch Panel

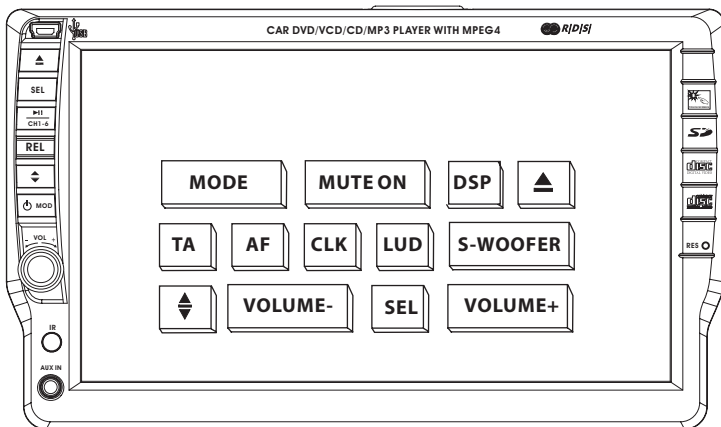

### Touch Screen Key :

**MODE** Operating mode selection

**CLK** Touch briefly show/hide clock, touch longer to set the clock .

**MUTE ON** To switch of the sound

**LUD** Loudness Function

**DSP** Select EQ function

**S-WOOFER** Subwoofer Function

**▲** Loading and ejecting the DVD/CD

**▲/▼** Changing the viewing angle of the operating unit

**TA** Turning pre-switching for traffic announcements ON and OFF . (Only for RDS)

**VOLUME-** Decrease the volume level

**AF** Switch ON and OFF and alternative frequency . (Only for RDS)

**SEL** Select the menu of the Picture/Sound

**VOLUME+** Increase the volume level

# Control Panel

## Unit Keys :

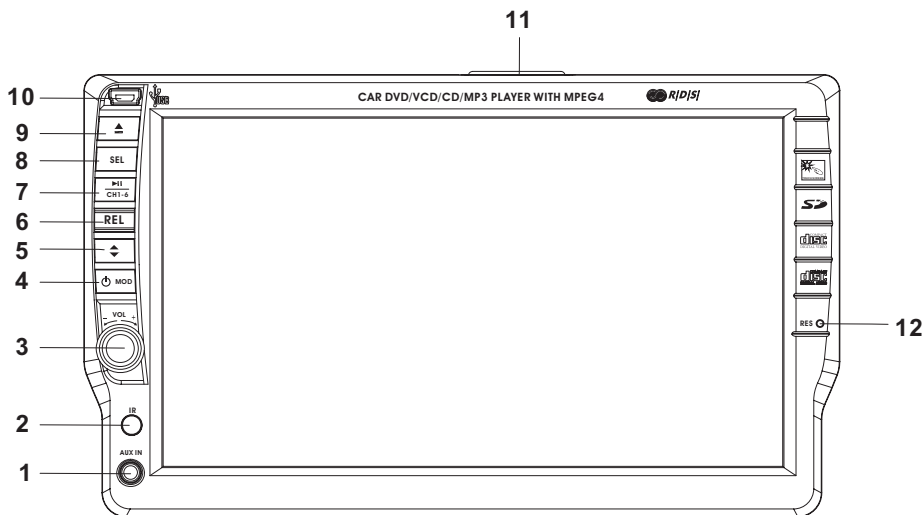

### 1 AUX Input JACK

For information about connecting a AUX device, please see page 25 .

### 2 IR SENSOR

### 3 VOL+ / VOL- KNOB

In normal mode, this knob is used to increase or decrease the volume. It is also used as an UP/DOWN knob when audio or video settings are being adjusted when accessed using the SELECT button.

### 4 (POWER On/Off) / MODE BUTTON

Press this button to switch the device on. WELCOME appears in the display. Press it again to switch the device off. SEE YOU appears in the display. In playback mode, you can use the button to select the input mode by pressing repeatedly until the proper one is found :  
**DISC > AUX IN > RADIO .**

### 5 ↕ ANGLE (Screen position)

Press this button repeatedly to cycle through the different positions.

# Control Panel

---

## 6 REL BUTTON

Press this button to release the front panel for removal . Refer to see page 7.

## 7 ► /CH 1-6 (RADIO PRESET)BUTTON

### A) In Disc Playback Mode

Press this button to pause playback, press it again to resume playback.

### B) In Radio Mode

you can store 30 stations in memory: 18 FM stations and 12 AM(MW) stations, each band stores up to six preset stations .

#### -Store in Memory

> Select the frequency band

> Press repeatedly the button to select the desired memory key .

> Select the station

> Keep the desired memory key pressed in until the station is heard again after a brief interruption .

#### -Retrieve a preset station

press the button repeatedly to retrieve a station which had been stored in the memory in advance the chose number is shown on display .

## 8 SELECT BUTTON

To access the available adjustment settings for audio and video, press this button repeatedly to cycle through and select them:



## 9 ▲ (EJECT) BUTTON

Press it button to eject the DISC or insert the DISC to start play .

## 10 USB OPERATION

For information about connecting a USB device, please see page 33.

## 11 SD/MMC CARD SLOT

## 12 RESET BUTTON

Press this button to return to factory settings .



# Basic Operation

## POWER On/Off



Press it to switch the device ON, press and hold about 2 seconds to switch the device OFF.

## Ejecting The Disc



Use your finger to touch the ▲ range on touch screen, the control panel of the unit will swing downwards. Then you can insert the disc or eject the disc. (You can also press the ▲ button on the front panel to eject the disc or insert the disc to start play.)

## Select Sources



Touch repeatedly the MOD section on the screen, the signals will display in the screen as follow :



## Volume Adjusting

Volume button



Revolve : clockwise to increase /  
Anticlockwise to decrease .

## Touch screen



Touch the screen the VOLUME+ to increase the volume level .



Touch the screen the VOLUME- to decrease the volume level .



## Mute Function



Touch "MUTE ON" range, it will mute the sound but the disc continues playing . Touch it again to resume .

## Setting The Clock



Touch briefly the "CLK" range to show/hide the clock .  
Touch hold for more than 2's the hour will flash , use the VOL+/- to adjust . Touch it again, the minute will flash, then use the VOL+/- to adjust .

## Setting The Buzzer ON/OFF



Repeatedly touch "SEL" range to select the **BUZZER** item, and the use the VOL+/- to switch the **BUZZER ON/OFF** .

## Setting the Background Color



In radio mode, repeatedly touch the "SEL" range to select the "wallpaper" item, and then use the VOL+/- to select the background color among of the "wallpaper **AUTO**, wallpaper: 01 ..... wallpaper: 11", in the "AUTO" mode, the monitor of unit will change the background color automatically .

# Basic Operation

## TFT Monitor Adjustment



During DISC playback, use your finger to touch briefly the SEL section on the screen (or press SEL button on front panel) to access the Picture mode



selection menu, by repeatedly touch the SEL section, and then touch the VOL+/- (or rotate the VOL+/-) to adjust the selected mode .

(The corresponding value will show on the monitor )

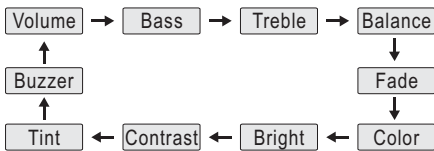

touch to select

touch to adjust

### ADJUSTABLE ITEMS:

**COLOR:** 0 to 32

Adjust the color for the picture-lighter or darker.

**BRIGHT:** 0 to 32

Adjust if the picture is too bright or too dark.

**CONTRAST:** 0 to 32

Adjust the contrast of the bright and dark portion.

**TINT:** 0 to 32

Adjust the tint if the human skin color is unnatural.

-Adjustable when "NTSC " is selected for "NTSC/PAL " .

## Rear View Camera

When connecting the rear view camera. the mirror image of the rear view through the rear view camera is automatically displayed on the monitor when you change the gear to the back position. (The monitor on the unit only.)

## Audio Quality Adjustment



During DISC playback, use your finger to touch briefly the SEL section on the screen (or press SEL button on the front panel )



to access the Sound mode selection menu, by repeatedly touch the SEL section, and then touch the vol+/- (or rotate the vol+/-) to adjust the selected mode . (The corresponding value will show on the monitor )

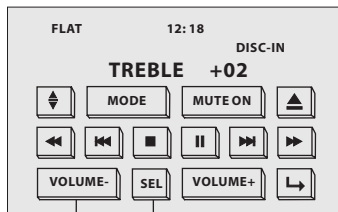
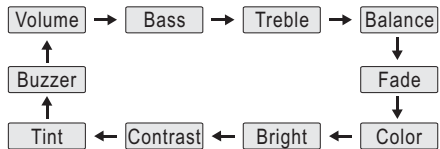

touch to select

touch to adjust

### ADJUSTABLE ITEMS:

**Volume:** 0 to 32

Adjust volume level by using VOL + / - .

**Bass:** -14 to +14

Adjust bass level by using VOL + / - .

**Treble:** -14 to +14

Adjust treble level by using VOL + / - .

# Basic Operation

**Balance:** R 0-10 to L 0-10 .

Adjust sound balance between left and right speakers by using VOL + / - .

**Fader:** F 0-10 to R 0-10 .

Adjust sound balance between front and rear speakers by using VOL + / VOL - .

## Setting Audio Modes

**DSP** Touch the screen the DSP range (or press the EQ button on the remote control ) to select one of the preset sound modes .

**(Rock/Pop/Jazz/Classic/Flat)** .

The information will display in the monitor as follow :

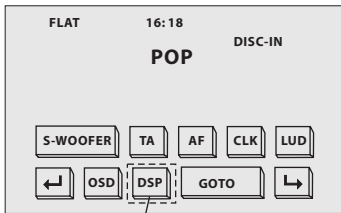
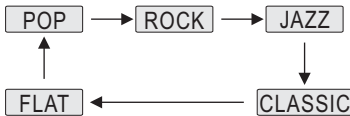

touch to select

It`s depend on your habit to select the Audio mode .

## Reset Factory Settings

RESET button is placed on the housing and must be activated with either a ballpoint pen or thin metal object.



The **RESET** button is to be activated for the following reasons:

- Initial installation of the unit when all wiring is completed.
- All the function buttons do not operate.
- Error symbol on the display.

## ALTERNATE AUDIO/VIDEO SOURCE

On the front panel of the unit , there is an AUX IN jack, to connect analogue replay devices. Use this jack to replay sound of other replay equipment such as DVD players, computers, etc. Via the loudspeakers.

- 1). Please following the diagram below, connect the external device with stereo jack plug the AUX IN socket .
- 2). Press the MOD button to select the AUX IN connection.
- 3). Use the buttons on the external device itself to operate it .

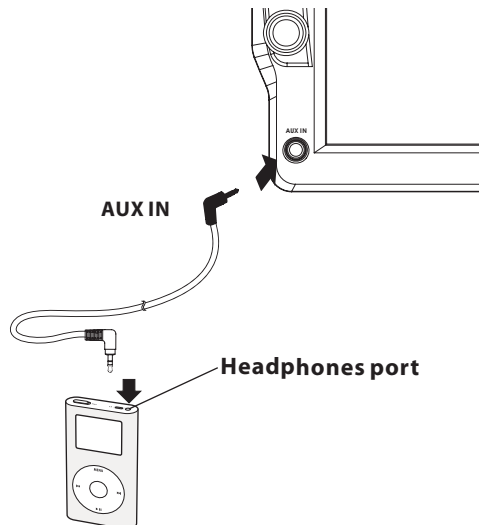

# Radio Operation

## Listening to the Radio

### Switching To Radio Mode

 Touch the screen of “**MODE**” range (or press the MOD button on the front panel ) repeatedly to select the RADIO mode. the following information will appears as below:

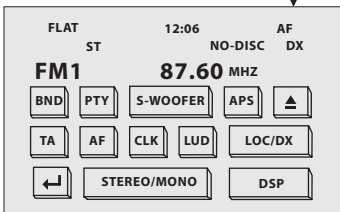
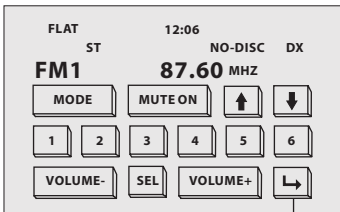

 Touch “  ” to next .

 Touch “  ” to previous .





### Selecting The Frequency Band

 Touch the screen of “**BND**” section (or press the **BND** on the front panel ) repeatedly to select the band , the message will show in turn :







## Start Searching For a Station

### Manual Search

During Radio mode, briefly touch the screen of “  ” section or press the “” on front panel to increase frequency by one step of channel spacing . Briefly touch the “  ” section or press the “” button on the front panel to decrease frequency by one step of channel spacing .

### Automatic Search

During Radio mode, touch and hold (for more than 2's ) the screen of “  /  ” section or press longer the “  /  ” on the front panel to start search for a radio station automatically .

## When an FM stereo broadcast is hard to receive

Touch the “**STEREO/MONO**” section on touch screen (or press **ST/MO** button on the remote control ) to select the MONO or STEREO mode . (When Stereo mode is activated, the ST symbol will appear . )

## To tune in strong-singnal FM Station only (LO/DX function)

Touch the “**LOC/DX**” range on the touch screen (or press LO/DX button on the remote control ) to select the LOCAL or DX mode . ( You can choose between the LOCAL and DX(DISTANCE) mode for local or long-distance traffic news . )

# Radio Operation

## Storing Stations In Memory

With this system, a total of 30 stations can be stored in the memory of six buttons. Each band stores up to six preset stations. The stations might be FM1, FM2, FM3, AM1(MW1), and AM2(MW2) band.

The operation is as below :

Touch the screen of the "1-6" sections

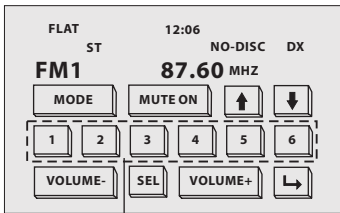

Touch to preset station

### -Store in Memory

- > Select the frequency band
- > Select the station
- > Keep the desired memory key pressed in until the station is heard again after a brief interruption .

### -Retrieve a preset station

Touch the **1-6 sections** briefly to retrieve a station which had been stored in the memory in advance the chose number is shown on display .

## Automatic Memory Storing & Program Scanning

### Automatic Preset Setup

 In Radio Mode, Touch and keep the APS section on the touch screen for about 2 seconds to active

automatic station storage. The radio searches within the current frequency band,

e.g. FM1, for the stronger signal level until the search cycle has finished . The six strongest stations are then allocated to the corresponding storage locations . Then the station of the first storage location is set .

## Scan Function

 In Radio mode, briefly touch the **APS** section on the touch screen , the radio briefly plays all the preset stations of the frequency band .

## RDS FUNCTION

 In Radio mode, touch it to select the desired item, it will display the following as below :

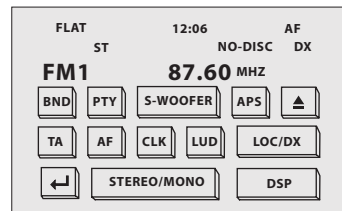

## TA Traffic Announcement

(Priority For Traffic Information)

 In Radio mode, touch briefly the screen of "TA" range to activate the TA function.

Touch it again to turn off the TA function . When the TA function is activated, the TA symbol appears in the display . During radio operation in one FM frequency band the search for a traffic announcement station is started automatically (TA SEEK) . If an FM station is being received which transmits the latest traffic announcements from time to time, the TP display lights up.

# Radio Operation

When the TA function is switched on , the FM traffic automatically interrupt CD operation(the word TRAFFIC appears in the display).

The volume level is increased to the minimum value for the transmission of traffic announcements.

After the traffic announcements has finished, the program that was previously running is resumed.

Interruption of the TA Function: if you would like to interrupt the current traffic announcement, touch the TA section on screen briefly . This does switch off the TA mode .

## **AF FUNCTION**

(Alternative Frequencies)



In Radio mode, touch briefly the screen of "AF" range to activate the AF function. Touch it again to turn off the AF function .



AF is a function that works with the help of RDS (Radio Data System) and can only be used with FM stations . The radio searches in the background for the best frequency reception of the station that has been tuned into .

Touch the AF section on touch screen or swing and keep the SEL knob in the TA/AF direction for about 2 seconds , the AF function is activated. The AF symbol appears in the display .

When the AF function has been switched on, the radio continuously tests the signal strength of the AF frequency . The test interval for each AF frequency depends on the signal strength of the current station and varies from a few minutes in the case of weak signals. Whenever the new AF frequency is stronger than the station that is currently tuned in , the radio switched to this frequency for a short time for a short time and the message "NEW FREQUENCY " is displayed for one or two seconds.

## **Note :**

the status of the AF function is shown by an AF symbol in the display.

- If the AF symbol appears in the display, the AF function is switched on and RDS transmission date is being received .
- If the AF symbol flashes in the display, the AF function is selected but no RDS signal can be received at the moment .

## **PTY FUNCTION**



In Radio mode, touch the screen of "PTY" range to select the Program type .



## **PTY Selection of the program type**

besides the stations name, some FM stations also transmit information on the type of program. This information can be displayed by your car radio .

Examples of such types of program are :

**SPORT NEWS POP WEATHER .....**

With PTY function you can specifically select stations transmitting a particular type of program. Touch the PTY range on screen repeatedly to call up the PTY selection menu . The message "PTY SEEK" then appears briefly in the display .

When PTY has been selected the radio starts searching for corresponding PTY information and stops when the PTY information has been found, "NO PTY" appears in the display. If the PTY information being searched for no longer exists, the PTY function automatically switches to normal mode .

# DISC Operation

## Basic Operation

During DISC playback, you can touch the screen to display the following:

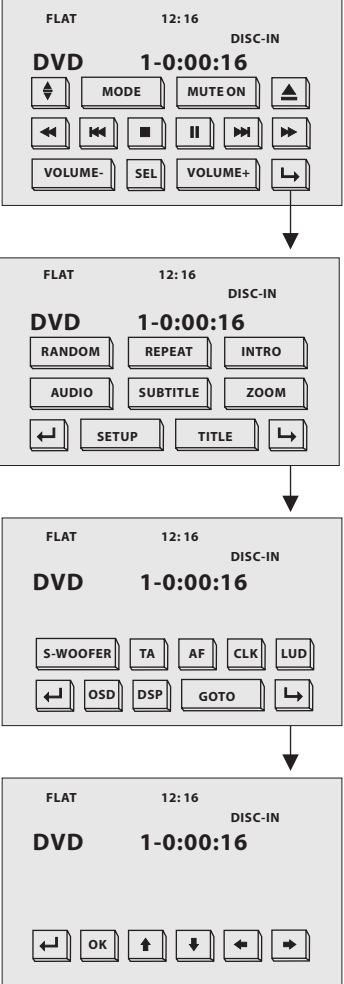

- Touch “ → ” to next .
- Touch “ ← ” to previous .

## Switching the DVD mode

Touch the screen of “MODE” range (or press MOD button on the front panel ) to select the DISC mode, it display like following :



**Function setup**  
(different the source the display is different)

## Stopping Play

- Touch the screen the ■ range (or press the ■ button on remote control .) To stop the unit playback. Touch the || section or press || button on front panel to start play.

## Pause (still picture)

- Touch the “ || ” section on touch screen during playback will stop play temporary, touch it again to return the normal playback .

## Rapid Forward/Rapid Reverse



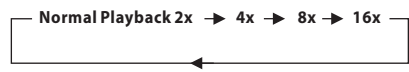

- During DISC playback, touch the screen of “ >>> / <<<< ” range or press longer (more than 2’s) the “ ^ / v ” button on the front panel , the speed of rapid forward/reverse changes according to the disc as follow:

### DVD/VCD/CD/MP3:





# DISC Operation

## Skipping Track













 During DISC playback, Touch the  /  section on the touch screen to skip to next/back one track. (You can also press the  /  on the front panel to skip to next /back one track.)

### Note :

1. In DVD mode, touch the  section continually twice to back one track . (Press the  button continually twice to back one track .)
2. For some VCD2.0 disc (PBC-playback control), above these buttons may be unavailable .

## Zoom Function

 Repeatedly touch the section of the ZOOM, the displaying rate can be 2x, 3x, 4x, 1/2, 1/3, 1/4 .

Use the direction keys ( /  /  /  on remote control or  /  /  /  on touch screen) to move the enlarged picture . Note: During the JPEG disc playback , touch the screen of "ZOOM" range , the "zoom 100%" word will display, then you can touch longer (more than 2's) the  /  section on touch screen (or press the  /  buttons on remote control ) to zoom in/zoom out the picture. In zoomed mode, use the direction keys to move the enlarged picture .

## Loud Function

 Touch the screen of "LUD" range to switch the Loudness function ON or OFF.

## Subwoofer Function

 Use your finger touch the "S-WOOFER" section on the screen to turn on the Subwoofer function, touch it again to cancel function .

## Selecting The Play Modes

During the Disc playback, touch the touch screen, it will display the following as below :



Touch to select

### 1). Repeat Function

#### FOR DVD :

Touch the screen the of "REPEAT" range (or press longer **2/RPT** button on the remote control) to select REPEAT mode as follow :



#### FOR VCD/CD/MP3 :

Touch the screen the of "REPEAT" range (or press longer **2/RPT** button on the remote control) to select REPEAT mode as follow :



1. Continuously repeat at the current chapter/track, when selected REP-ONE mode .
2. Select REP-ALL mode to continuously repeat all chapter/track on the current disc .

### 2). RDM(RANDOM) Function

During DISC playback, touch screen of "RANDOM" section ( press the **4/RDM** button longer on the remote control to play in random.



# DISC Operation

Each playing, the order is different .  
(Depend on the disc used for VCD).  
Touch it again to cancel this function .  
Note : in random mode, the ⏮ button is not available .

## 3). INT Function

### FOR CD :

Touch the screen of the "INTRO" section  
(or longer press the 3/INT button on the remote control ) to play the previous 6 seconds part of each track/chapter on disc. (Touch it again to cancel this mode)

### FOR VCD :

Touch the screen of the "INTRO" section  
(or longer press the 3/INT button on the remote control ). It display will following menu as below :  
(touch it again to cancel this mode .)

**SELECT DIGEST TYPE:**  
TRACK DIGEST  
DISC INTERVAL  
TRACK INTERVAL

Use the UP, DOWN, LEFT and RIGHT arrows on the remote to select the item, and then press ENTER to confirm .

### FOR DVD :

Touch the screen of the "INTRO" section  
(or longer press the 3/INT button on the remote control ). It display will following menu as below :  
(touch it again to cancel this mode .)

**SELECT DIGEST TYPE:**  
TITLE DIGEST  
CHAPTER DIGEST  
TITLE INTERVAL  
CHAPTER INTERVAL

Use the UP, DOWN, LEFT and RIGHT arrows on the remote to select the item, and then press ENTER to confirm .

**NOTE :** For MP3, the 3/INT button is not available.

## DISC Search (GOTO)

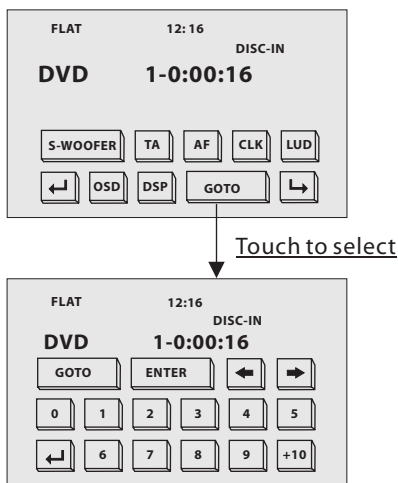

### FOR DVD :

Touch the screen the of "GOTO" range  
(or press the GOTO button on the remote control ) Twice, the screen will display the following message :

Title 01/01 Time ---:--  
0:10:36

You can select the item you want to watch through TIME setting by using numeric buttons . (E.x. 0:10:36)

### FOR VCD (With PBC OFF):

Touch the screen the of "GOTO" range  
(or press the GOTO button on the remote control )Once, the screen will display the following message :

Disc Go To ---:--  
00:36

Use the numeric buttons to input the time directly (E.x. : 00:36)

# DISC Operation

## Note:

Touch and hold the ← / → section on the touch screen , you can select the title or chapter of DVD . (Only for the DVD with title /chapter.)

## AUX Operation

On the front panel of this unit, there is an AUX IN jack, follow the diagram below to connect analogue replay devices.

Use this jack to replay sound of other replay equipment such as DVD players, computers, etc. Via the loudspeakers.

### AUX IN JACK FRONT PANEL

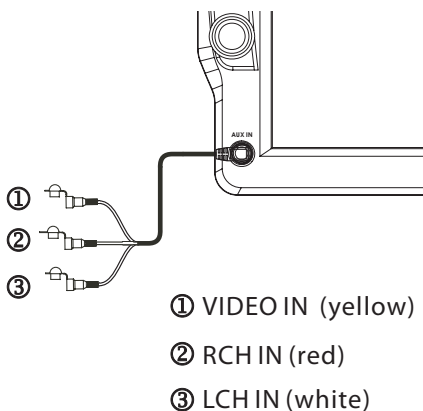

1) Please connect the external device with stereo jack plug the Aux in socket .

2) Touch the MOD section on screen or press the MOD button to select the AUX IN connection. It will display the following as below :

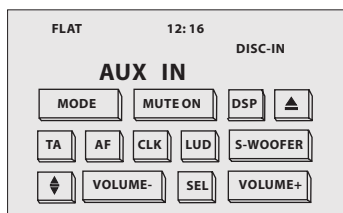

3) You now hear the sound from the external device played back through the loudspeakers .

4) Touch the volume+/- sections on touch screen or use the VOL+/- on the remote to adjust the volume level.

# DISC Operation

## ON-SCREEN DISPLAY FUNCTION

 During playback, touch the screen the OSD section (or press the OSD on the remote), it will display the following as below :

1. DVD:

A. Touch or Press **OSD** for first time:

```
TITLE ELAPSED
T 01/01 C 01/38 0:02:06
```

Title Number, Total Title Number, Chapter Number, Total Chapter Number of this Title of the disc currently being played will be shown on the screen, along with the elapsed time.

B. Touch or Press **OSD** for second time:

```
TITLE REMAIN
T 01/01 C 01/38 3:24:36
```

C. Touch or Press **OSD** for hird time:

```
CHAPTER ELAPSED
T 01/01 C 01/38 0:02:56
```

D. Touch or Press **OSD** for fourth time:

```
CHAPTER REMAIN
T 01/01 C 01/38 0:04:32
```

E. Touch or Press **OSD** for fifth time:  
The message on the screen will be cleared.

2.Example for VCD/SVCD/CD:

A. Touch or Press **OSD** for first time:

```
SINGLE ELAPSED
TRACK 01/16 0:00:56
```

B. Touch or Press **OSD** for second time:

```
SINGLE REMAIN
TRACK 01/16 0:05:10
```

C. Touch or Press **OSD** for hird time:

```
TOTAL ELAPSED
TRACK 01/16 0:31:36
```

D. Touch or Press **OSD** for fourth time:

```
TOTAL REMAIN
TRACK 01/16 0:36:26
```

E. Touch or Press **OSD** for the fifth time:  
The message on the screen will be cleared for SVCD and VCD.

### NOTE:

For CD and MP3, the message will always display on the screen.

3.Example for MP3:

Each time **OSD** is pressed or touch , the message displayed on screen changes as follows:

```
SINGLE ELAPSED → SINGLE REMAIN
←
```

# DISC Special Functions

## DVD/VCD Special Function

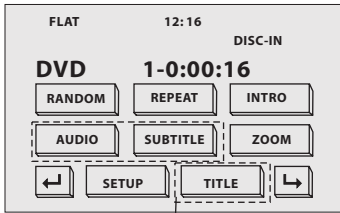

**Touch to select**

### 1. Multi-subtitle Language Function (for DVD Only)

**SUBTITLE** During DVD playback. Touch the **SUBTITLE** section on touch screen (or press the SUBTITLE on the remote).

Each time the button is pressed or touch, number of the subtitle language changes in sequential order.

#### Notes:

- The language number is different according to the disc.
- Some discs only contain one subtitle language.
- When no different subtitle language are recorded,  will be displayed at screen left top corner.

### 2. Multi-Audio Language Function

**AUDIO** For DVD: During DVD playback, touch the **AUDIO** section on touch screen (or press the AUDIO on the remote.) Each time the button is pressed or touch, number of the audio soundtrack language changes on sequential order.

#### Notes:

- The language number is different according to the disc.
- Some disc only contain one language soundtrack
- When no different language soundtrack are recorded  will be display at screen left top corner.

### For VCD/CD:

during playback, touch the **AUDIO** section of the touch screen or Press **AUDIO** on the remote. It is possible to switch the sound between monaural and stereo sound.



### 3. Multi-Angle Function (for DVD Only)

**ANGLE** During DVD playback, touch the **ANGLE** section or Press ANGLE button on the remote. Each time the button is pressed or touch, number of the angle changes in sequential order.

#### Notes:

- The angle number is different according to the disc.
- The function only work for disc having scenes recorded at different angles.
- When no different angle are recorded,  will be displayed at screen left top corner.

### 4. Title Menu Function

**TITLE** For DVD: If the DVD has multiple titles recorded on the disc. It can select preferred title from the title menu to start playback.

- During DVD playback, touch the **TITLE** section or press TITLE button on the remote. The title menu is display.
- Touch the cursor button shown in TV screen, select preferred title by the cursor button and confirmed by touch ENT button.

#### For VCD:

Press **TITLE/PBC** button on the remote control while the disc is playing, you can switch between "PBC on" and "PBC off" mode.

# Setup

## USING THE MENU

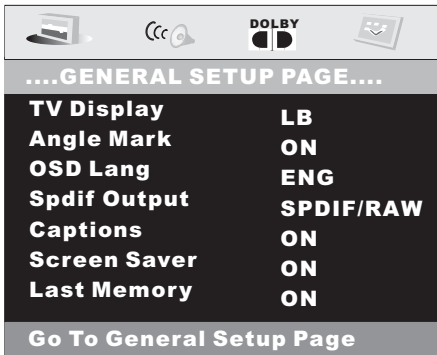

1. Touch the screen of "SETUP" range or press the **SETUP** button on remote .
2. The SETUP menu is displayed.
3. Select the preferred item by touch the **↑ / ↓ / ← / →** range on the screen or by using the **▶ / ◀ / ▼ / ▲** buttons .
4. Touch screen of the "OK" range or Press **ENTER** on the remote to confirm .

### The Following Buttons For Entering The Selection.

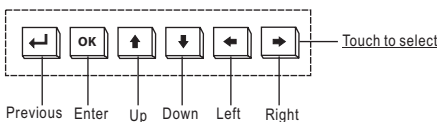

The buttons of the left and right are for selection of setting type .  
The buttons of the up and down are for selection of the setting program .

### Overview Of The Main Menu

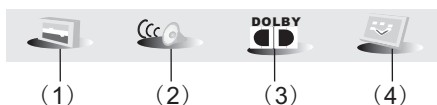

- (1) General Settings
- (2) Speaker Settings
- (3) DOLBY Digital Settings
- (4) Preference Settings

## GENERAL SETUP

### TV Setting

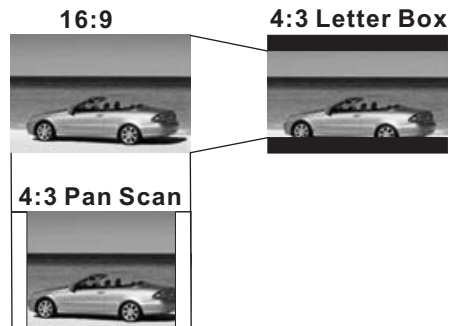
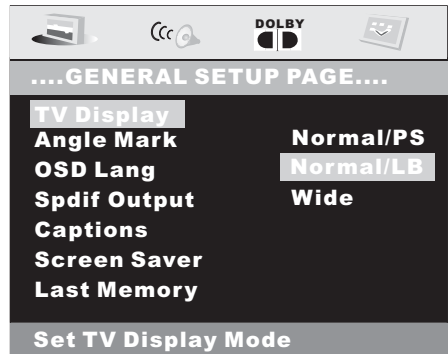

### 1. TV DISPLAY SETUP

This is to select the appropriate TV aspect (4:3 or 16:9) according to the connected TV set.

#### **Normal/PS (For 4:3 TV)**

Played back in the PAN & SCAN style.  
(If connected to wide-screen TV, the left and right edges are cut off.)

#### **Normal/LB (For 4:3 TV)**

Played back in LETTER BOX style.  
(If connected to wide-screen TV, black bands appear at top and bottom of the screen.)

#### **Wide (For 16:9 TV)**

Select when a wide-screen TV set is connected.

# Setup

## GENERAL SETUP

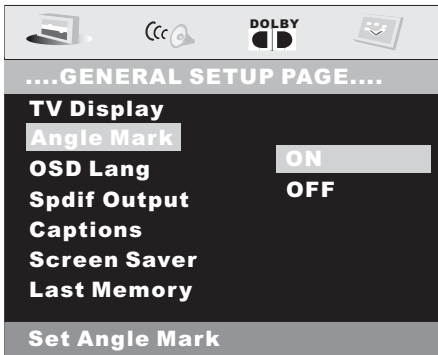

### 2.ANGLE MARK DISPLAY SETUP

If it is set to ON, when the multi-angle DVD disc is playing,  (the angle mark) will appear on the screen; if it is set to OFF, the mark will not appear.

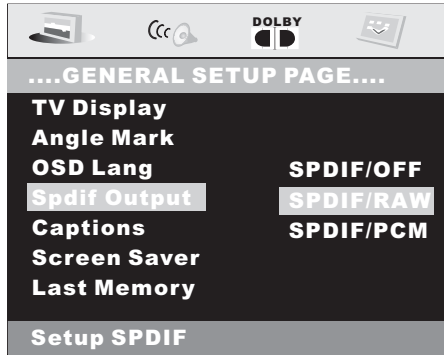



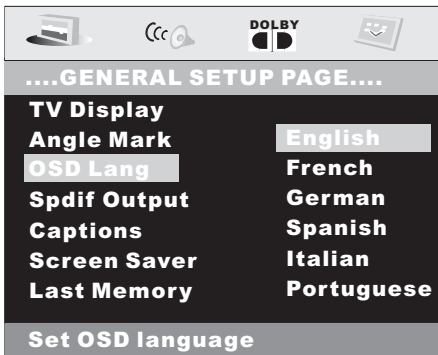

### 4.SPDIFF OUTPUT

This is to activate the audio output from SPDIF OFF mode to SPDIF/RAW mode to SPDIF/PCM mode.

## LANGUAGE DISPLAYING



### 3.OSD LANG TYPE SETUP

Touch the  /  section on the touch screen or press the  /  button on the remote to select the preferred OSD language, then touch the **OK** section to confirm.

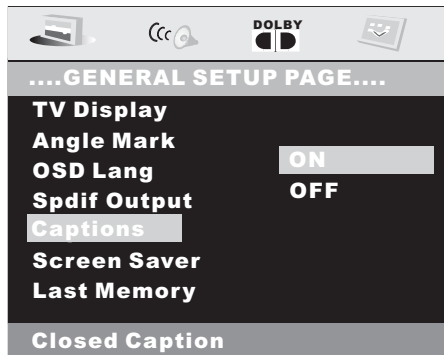

### 5.CAPTIONS SETUP

Activate the CAPTIONS feature by selecting ON. And release this feature by selecting OFF.

# Setup

## GENERAL SETUP

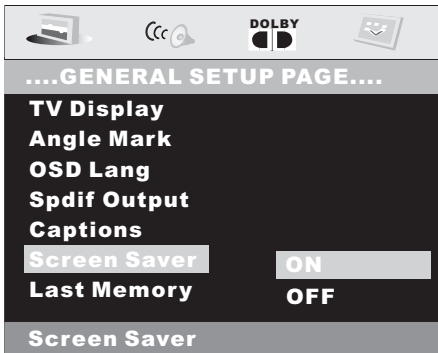

### 6. SCREENSAVER SETUP

If the screen displays a static image for too long, some "burn-in" may occur, leaving a permanent trace of the image behind. To avoid this, turn ON the SCREENSAVER item. After a short period of inactivity on the monitor, the unit will substitute a moving image to avoid burn-in.

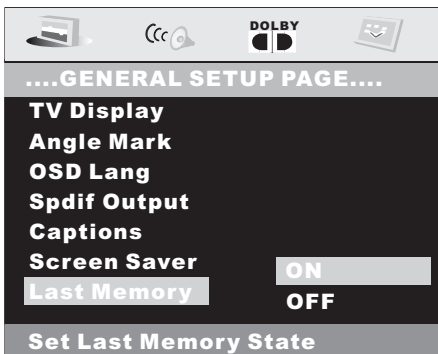

### 7. LAST MEMORY SETUP

Select the LAST MEMORY output ON/OFF.

## SPEAKER SETUP

.....Speaker Setup Page.....

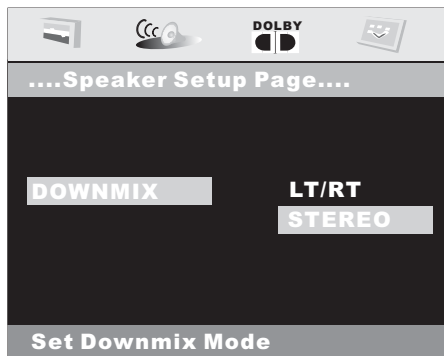

### DOLBY DOWNMIX

Many DVD discs are recorded using a surround sound recording technology called Dolby AC3 5.1. When such a disc is played in a normal 2- or 4-channel playback unit like this one, the surround sound must be "downmixed" to stereo. In this case, choose "stereo," unless the output from this unit is connected to a mobile Dolby surround sound system. In that case, choose LT/RT.

## DOLBY DIGITAL SETUP

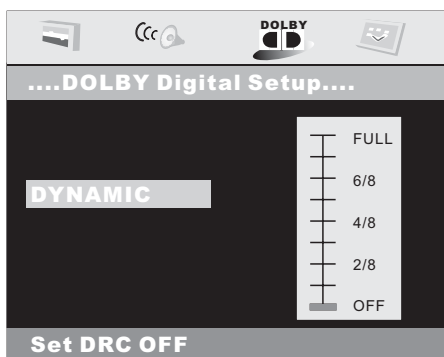

### DYNAMIC RANGE CONTROL

Select DRC and adjust the dynamic range of a Dolby Digital encoded program. There are 8 steps between full compression and off compression.

# Setup

## --- PREFERENCES PAGE ---

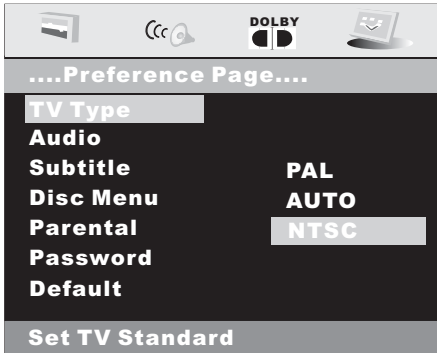

### 1. TV TYPE SETUP

This player is capable of playing discs recorded in either PAL or NTSC formats. Make the selection based on whether you are connecting the unit to a PAL TV or an NTSC TV. You can also set the unit to AUTO (autoselect). The disadvantage to autoselect is that each time you turn the unit on it checks to see what kind of monitor is connected, which causes a small delay and some flickering of the display image which you may find unpleasant.



### 2. AUDIO LANGUAGE SETUP

Select the preferred AUDIO soundtrack language using the cursor buttons.

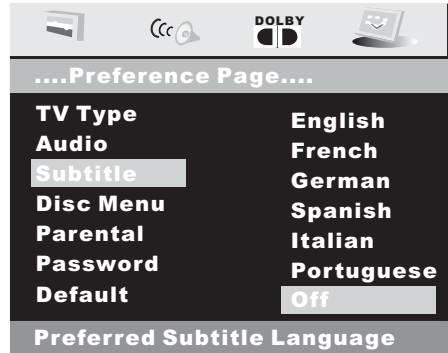

### 3. SUBTITLE LANGUAGE SETUP

Select the preferred SUBTITLE language by using the cursor buttons.



### 4. DISC MENU LANGUAGE SETUP

Select the preferred DISC MENU language by using the cursor buttons.



# Setup

## --- PREFERENCES PAGE ---

### Age control

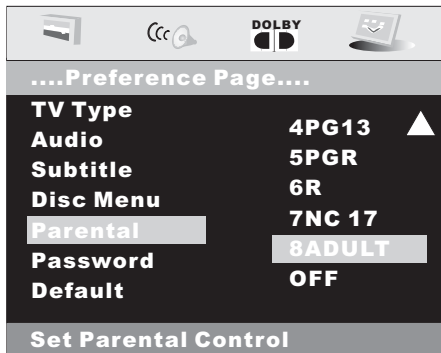

### 5.PARENTAL

Select suitable parental guidance with the cursor buttons and confirm it by pressing the ENTER button.

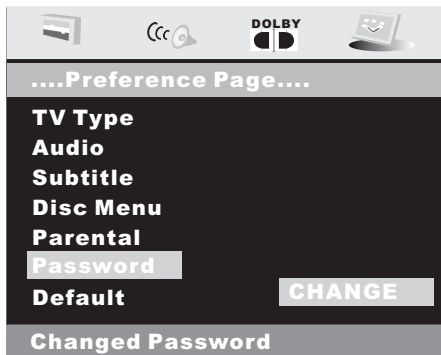

### 6.PASSWORD SELECTION

The password must be used to make changes to the Parental Control menu above. The factory default password is **1379**. To change this password, press change. You will be asked for the current password. Once you have entered it, you have the opportunity to change it. Then, when you enter the Parental Control menu, you will be required to use this new password in order to make any changes.

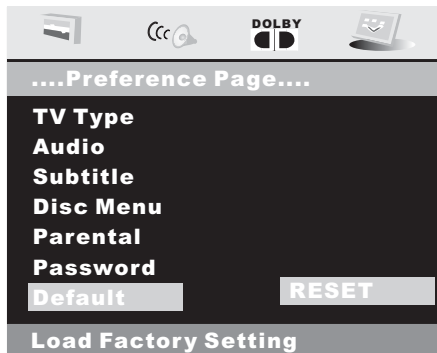

### 7.DEFAULTS

Selecting the DEFAULT item and confirming RESET will return ALL personal settings you have made, including radio and TV presets, to the factory default settings.

## DEFAULTS TABLE

|               |              |           |
|---------------|--------------|-----------|
| GENERAL SETUP | TV DISPLAY   | NORMAL/LB |
|               | ANGLE MARK   | ON        |
|               | OSD LANGUAGE | ENGLISH   |
|               | SPDIF OUPUT  | SPDIF/RAM |
|               | CAPTIONS     | ON        |
|               | SCR SAVER    | ON        |
|               | LAST MEMORY  | ON        |
| SPEAKER SETUP | DOWNMIX      | STEREO    |
| DOLBY DIGITAL | DYNAMIC      | OFF       |
| PREFERENCES   | TV TYPE      | AUTO      |
|               | AUDIO        | ENGLISH   |
|               | SUBTITLE     | OFF       |
|               | DISC MENU    | ENGLISH   |
|               | PARENTAL     | 8 ADULT   |
| PASSWORD      | 1379         |           |

# Other Main Operation

## USB Operation

Following the diagram below, connect your USB device to the front panel USB port. If it is properly connected, the device will be mounted and start playing automatically.

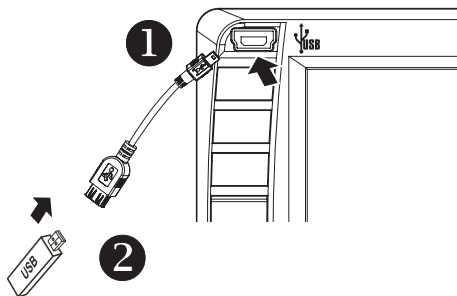

## Changing From DISC to USB Playback Modes

If the disc present in the player is an MP3 disc, touch ■ section on screen or press the STOP on remote once then touch or press the GOTO to USB playback.

If the disc present in the player is an DVD or VCD or CD disc, touch ■ on the screen or press STOP twice on the remote then touch GOTO section on the screen or press the GOTO button on the remote to USB playback.

## Important Note:

To prevent damage to the USB device, do not remove or disconnect it during playback. it is also a good practice to remove the USB drive during disc playback.

## In USB Playback mode

Use the UP, DOWN, RIGHT or LEFT buttons to navigate to and select files to play, and press ENTER to begin playback (or viewing, in the case of JPEG files). To skip to the next or last track, touch or press the ►► or ◀◀. Press the ►► or ◀◀ buttons for Fast Forward or Fast Reverse playback. **REPEAT** play modes are also available by repeatedly pushing **REPEAT** until the desired mode is found.

## Changing From USB to DISC Playback modes

If you are in USB Playback mode and wish to begin playback of a disc already in the player, touch the ■ range on the touch screen or press the STOP on the remote once. Then touch GOTO range on the screen or press the GOTO on the remote and the player will switch to DVD/VCD/CD/MP3 Playback mode.

# Other Main Operation

---

## SD/MMC card OPERATION

The unit can support playback MP3/WMA/JPEG/MP4 and Divx format which are stored into SD and MMC memory card .

Please read below before you start the operation of memory card .

### Inserting and removing a SD or MMC card on the front panel of unit .

#### Inserting the SD or MMC card .

①

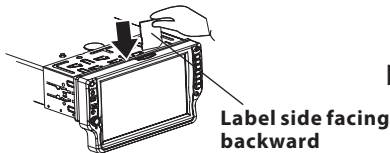

Insert the memory card into slot with label side facing backward .

②

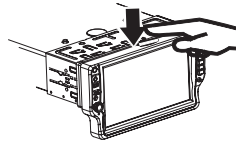

Press in till heard a **"CLICK"** .

#### Removing the SD or MMC card .

①

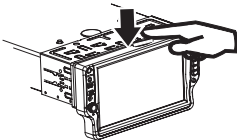

Press in till heard a **"CLICK"** .

②

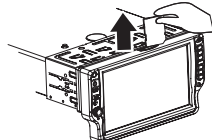

Remove the memory card .

### **Mode change to SD/MMC card**

After a SD or MMC card was inserted into the main unit card slot . The unit will starts playing the files contained on the memory card . Once the unit read the memory card successfully, the first file on the memory card will automatically start play back . Press the mode button repeatedly is allowing changing to other modes .

### **Change DISC to SD/MMC card**

The operations are same as USB mode, refer to see USB operation .

### **Change SD/MMC card to DISC**

The operations are same as USB mode, refer to see USB operation .

### **File Playback Operation**

All the SD or MMC memory car playback operation function is same as the operation on **CD/MP3/WMA** .

Please to **"MP3/WMA"** operation for more details .

# Other Main Operation

## MP3/WMA/JPEG/MPEG4 DISC PLAY

When you insert a disc which contains MP3, WMA or JPEG files, the different file types are detected, and a list of the files are produced, as shown in the diagram below.

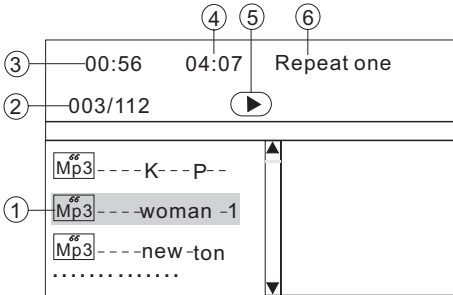

- 1 Current track(file)(highlighted bar)
- 2 Current track (file) number/total number of tracks(files) in the current folder.
- 3 Elapsed playing time of the current track(not available for JPEG disc)
- 4 total playing time.( not available for JPEG disc)
- 5 Operation mode icon. ▶ (Play), ■ (stop), || (pause), ►► (forward) ◀◀ (reverse).
- 6 Selected playback mode

Touch the screen, it will display the following as below :  
(when the parking brake is applied .)

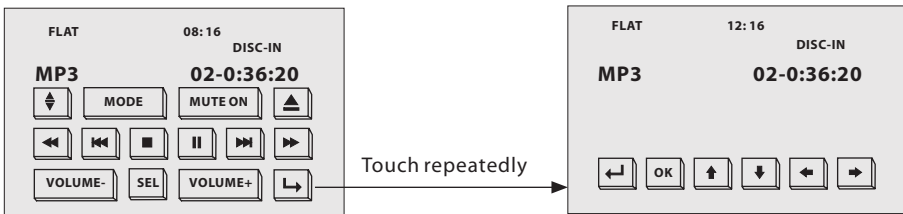

In stop mode, touch the ↑ / ↓ / ← / → sections on touch screen (or Use ▲ / ▼ / ► / ◀ on the remote control ) to select the item or folder, then touch the “OK” range (or press **ENTER** button on the remote control ) to confirm.

Touch the screen of “REPEAT” range or press longer “REPEAT” on the remote control repeatedly can select two kinds of repeat play mode.

### REP-ONE:

Play the same song over and over again.

### REP ALL:

Play all songs on the disc, then repeats the entire disc over and over again .

### Moving To Another Track :

1. Touch the ►► or ◀◀ section to skip a track ahead or back.
2. Press the ▲ or ▼ button to skip a track ahead or back.

### Fast Forward/Fast Backward

1. Touch briefly the “►► / ◀◀” range on touch screen for fast forward / fast backward.
2. Press longer the ▲ or ▼ button for forward or backward .

# Specification

---

## General:

|                      |   |                         |  |
|----------------------|---|-------------------------|--|
| Supply Voltage:      | 12V DC (11V-15V)  |                         |  |
| Current Consumption: | Less than 10 A  |                         |  |
| Signal System:       | Compositive video 1.0Vp-p 75 $\Omega$   |                         |  |
| Discs Played:        | (1)DVD-VIDEO Disc<br>5"(12 cm) single-sided, single-layer<br>5"(12 cm) single-sided, double-layer<br>(2)Compact Disc (CD-DA, VIDEO CD)<br>5"(12cm) disc |                         |  |
| Audio Signal Output: | 2ch&4ch line out  |                         |  |
| Characteristics:     | (1)Frequency Response   | 20 Hz - 20 KHz          |  |
|                      | (2)S/N Ratio  | 90 dB (JIS)             |  |
|                      | (3)Wow and Flutter  | Below measurable limits |  |

## RADIO Section:

|                            | For 3 Bands<br>(Europe)<br>FM | For 2 Bands<br>(Europe)<br>FM | For 2 Bands<br>(U.S.A.)<br>FM |
|----------------------------|-------------------------------|-------------------------------|-------------------------------|
| Frequency Coverage:        | 87.5 to 108 MHz               | 87.5 to 108 MHz               | 87.5 to 107.9 MHz             |
| IF:                        | 10.7 MHz                      | 10.7 MHz                      | 10.7 MHz                      |
| Sensitivity (S/N = 30 dB): | 15 dBu                        | 15 dBu                        | 15dBu                         |
|                            | MW                            | MW                            | AM                            |
| Frequency Coverage:        | 522 to 1620 KHz               | 522 to 1620 KHz               | 530 to 1710 KHz               |
| IF:                        | 450 KHz                       | 450 KHz                       | 450 KHz                       |
| Sensitivity (S/N = 20 dB): | 40 dBu                        | 40 dBu                        | 40 dBu                        |

## TFT Monitor:

|                      |                        |
|----------------------|------------------------|
| Monitor Screen Size: | 7 Inch Wide            |
| Number of Pixels:    | 480 X RGB X 234 pixels |
| Color System:        | NTSC/PAL               |

## NOTE:

Specifications and design are subject to modification, without notice, due to improvements in technology.

# Trouble Shooting

Before going through the check list, check wiring connection. If any of the problems persist after check list has been made, consult your nearest service dealer.

| SYMPTOM                                    | CAUSE   | SOLUTION  |
|--|---|---|
| No power                                   | The car ignition switch is not on                                 | If the power supply is properly connected to the car accessory terminal, switch the ignition key to "ACC"   |
|  | The fuse is blown   | Replace the fuse  |
| Disc can not be loaded or ejected          | Presence of disc inside the player.                               | Remove the disc in the player, then put a new one   |
|  | Inserting the disc in reverse direction                           | Insert the compact disc with the label facing upward  |
|  | The disc is extremely dirty or defective                          | Clean the disc or try to play a new one   |
|  | Temperature inside the car is too high                            | Cool off or until the ambient temperature return to normal  |
| Television/video image appears black-white | The color system is set incorrectly                               | Please switch to correct color system from menu   |
| No television/video image appears          | The unit is not connected to the parking brake detection switch   | Make proper connection according to "wire connection"   |
|  | The parking brake is not engaged                                  | For safety reasons no television /video images are displayed while the vehicle is moving. Engaging the parking brake will cause images to be displayed. |
| No color in picture                        | The disc format is not according to the TV-set used (PAL/NTSC)    | Please the television mode of the choice accommodation  |
| JPEG disc can not be played back           | No JPEG files are recorded on the disc.                           | Change the disc   |
|  | JPEG files are not recorded in a compliant format                 | Change the disc Record JPEG files using a compliant application   |
| The operation keys do not work             | The built-in microcomputer is not operating properly due to noise | Press the RESET button. Front panel is not properly fixed into its place  |
| The radio does not work                    | The antenna cable is not connected                                | Insert the antenna cable firmly   |
|  | The signals are too weak  | Select a station manually   |

888-J9000-03S

## Free Manuals Download Website

<http://myh66.com>

<http://usermanuals.us>

<http://www.somanuals.com>

<http://www.4manuals.cc>

<http://www.manual-lib.com>

<http://www.404manual.com>

<http://www.luxmanual.com>

<http://aubethermostatmanual.com>

Golf course search by state

<http://golfingnear.com>

Email search by domain

<http://emailbydomain.com>

Auto manuals search

<http://auto.somanuals.com>

TV manuals search

<http://tv.somanuals.com>