

PYLE

OWNER'S MANUAL

PLDNV71BTU



**7" Motorized TFT Touch Screen, Detachable panel
DVD/CD/MP3 -MP4 Player/AM/FM/SD Card-USB/w- Bluetooth
Built-In Navigation System
Including Text-to-speech and turn-by-turn voice prompts
Allow you to keep your eyes on the road while navigating
w/USA/Canada & Mexico Maps included**

www.pyleaudio.com

Contents

Thank you for buying this product.

Please read through these operation instruments so you will know how to operate your model properly. After reading please keep this booklet in safe place for future reference.

1 Before You Start

- Important Safeguards* 4
- About this manual* 4
- Precautions* 5
- Maintenance* 6
- Location & function of the controls* 7
- Remote control* 8
- Specifications* 11

2 Installation

- Wiring Connections* 12
- Install the Unit* 13
- Detach the Unit* 14
- Install the Front Panel* 15
- Detach the Front Panel* 15

3 Common Operations

- To Select Source by Menu* 16
- Reset the Unit* 16
- Turning the Unit On/Off* 16
- Volume Control* 16
- Setting the Sound Characteristics* 16
- EQ Setting* 17
- Turning Loudness On/Off* 17
- Eject a Disc* 17
- Insert a SD Card* 17
- Mute Function* 17
- Mode Selector* 17
- Infrared Sensor* 17
- Double Function* 17

4 Main Menu

- Main Menu Setup* 18
- Video Adjust* 18
- Audio Adjust* 18
- Source Setup* 18
- System Adjust* 18

5 DVD/VCD/MP4

- DVD/VCD/MP4 Setup* 23
- DVD/VCD/MP4 Play* 23
- Selecting Tracks Fast* 23
- Number Buttons* 23
- Pause the Playback* 23
- Stop the Playback* 23
- Play tracks at Random* 24
- Repeat Playing* 24
- Skip backward/forward/F.F./REW the Playback* 24
- System Switch* 24
- Slow Motion Playback* 24
- Increase Picture Size* 24
- On Screen Display* 24
- Setting the Playback Time* 25
- Changing Audio Language* 25
- Changing the Subtitle Language* 25
- Changing the Viewing Angle* 25
- Selecting Channel* 25
- Program Playing* 25
- Playing PBC(Menu)* 25
- Selecting Menu* 27
- DVD Setup Menu* 27

Contents

6 CD/MP3/SD/USB

- CD/MP3/SD/USB Setup* 34
- CD/MP3/SD/USB Play* 34
- Selecting Tracks Fast* 34
- Repeat Playing* 35
- Number Buttons* 35
- Selecting Track* 35
- Stop Play* 35
- Playing Tracks at Random* 35
- Pause the Playback* 35
- Skip backward/forward/F.F/F.REW the Playback* 35
- Slow Motion Play* 38
- On Screen Display* 38
- Program Playing* 38
- Eject SD Card* 38
- Eject USB* 38

7 Tuner

- Listening to the Radio* 37
- Band Selector* 37
- Manual/Automatic Tuning* 37
- DX/LOC Selector* 37
- Selecting the Stored Station* 37
- MO/ST Selector* 38
- Scanning/Memorizing Stations Automatically* 38
- Number Buttons* 38
- On Screen Display* 38

8 AUX

- AUX Touch Screen Menu* 38

9 Bluetooth

- Bluetooth Operational Interface* 40
- Using a Bluetooth Wireless connection* 40
- Pairing Your Unit and Bluetooth Phone* 40
- Pairing in Handsfree Mode* 40
- Cellphone Pairing Mode* 41
- Bluetooth Connection and Disconnection* 41
- Using the Unit as a Handsfree Device* 41
- Last Number Dialing* 41
- To Dial by Cellphone* 41
- To Dial by the Unit* 42
- Using the Unit as Bluetooth Music* 42
- Audio Transfer between The Unit and Phone* 42

10 Additional Information

- Simple Troubleshooting Guide* 43

11 GPS

- For more information as to operate navigation system, please refer to the iGO8_UserManual*

Before You Start

IMPORTANT SAFEGUARDS

- 1 Be sure to connect the color coded leads according to the diagram. Incorrect connections may cause the unit to malfunction or damage the vehicle's electrical system.
- 2 Be sure to connect the speaker (-) leads to the speaker (-) terminal. Never connect the left and right channel speaker cables each other or to the vehicle body.
- 3 Make sure all the connections are completely correct before turning on your unit.
- 4 When replacing the fuse(s), the replacement must be of the same amperage as shown on the fuse holder.
- 5 Do not block vents or radiator panels. Blocking them will cause heat to build up inside and may result in fire.
- 6 To lest the driver distract his attention from, please install the unit in an apt place.
- 7 Using the unit after starting the engine, otherwise the unit can not be started, because the electric energy of battery was used up.
- 8 The unit must be screened from direct sunlight, or the electric energy of battery will be wasting for the high temperature.
- 9 Do not use the unit in extreme high temperature or such low temperature conditions, and also avoid humidity and direct sunlight.
- 10 Take care of the magnetism of the unit. Do no put the credit card, cassette or watch around the unit, or they would be broken or some information in them lose.
- 11 To lest disturb the video frequency, keep far away from the unit when using your phone.
- 12 Do not put the remote control under high temperature or where the sun strikes it, or else the control remote can not work normally.

About this manual

This unit features a number of sophisticated functions ensuring superior operation. All the functions have been designed for the easiest possible use, but many are not self-explanatory. This manual will help you understand the functions and operations of the unit.

Before You Start

PRECAUTIONS

This unit can play the following discs only:

Type of disc	Label on the disc	Recorded material	Size of disc
DVD		Sound and moving pictures	12cm
VCD		Sound and moving pictures	12cm
CD		Sound only	12cm
MP3		Sound only	12cm
MPEG-4		Sound and moving pictures	12cm

NOTE: The unit is compatible with VCD1.0/1.1/2.0/3.0 version and DVCD disc.

- **Do not attempt to modify the unit, modifying the unit may cause an accident.**
- **Stop the vehicle before carrying out any operation that could interfere with your driving.**
- **Do not work in extremely high or low temperature. Be sure the temperature inside the vehicle is between +60° C and -10° C before turning on your unit .**
- **To enjoy optimum sound and images while playing, handle the discs as follows:**
 - Do not use your CDs with paste residue or ink attached.
 - Do not use CDs with labels or stickers attached, which may leave a sticky residue while beginning to peel off. (Shown as the picture)
 - Clean the discs with an optional cleaning cloth. Wipe each disc from the center out. (Shown as the picture)

—Handle the disc by its edge to keep the disc clean, and do not touch the surface.



Besides playing the discs above, the unit also can be connected to other connector. Please refer to the details on page 19 before you playing them.

Before You Start

Maintenance

Replacing the Fuse

Make sure the amperage matches the specified value when replacing the fuses. If the fuse is blown, check the power connection and replace with a new one. If the same problem occurs, it would be subjected to the malfunction. In such cases, please consult to the nearest service dealer.

▲ Warning

Never use the fuse with the rated amperage more than that supplied to your unit, otherwise it will damage the unit.

Replacing the Battery

When the range of the operation of the card remote control becomes short or no functions while operating. Replace the lithium battery with a new button cell (CR2025). Make sure the battery polarity before replace.

Gently pull out the Battery Holder while pressing the Stopper.



Put the button-type battery with mark(+) upward into the Battery Holder.



Insert the Battery Holder into the Remote Control.



Precautions on Using Lithium Battery

Always keep the lithium battery beyond children's reach. In case swallowed, see a doctor immediately.

Cleaning the battery with a dry cloth, to ensure its perfect connected.

Make sure the proper polarity when loading with the battery.

To prevent short circuit, do not use metal tweezer to clip the battery.

▲ Warning!

Improper handle with the battery may lead to explosion. It cannot be charged, disassembled or thrown into a fire.

Before You Start

Location of the Controls

The Expanding

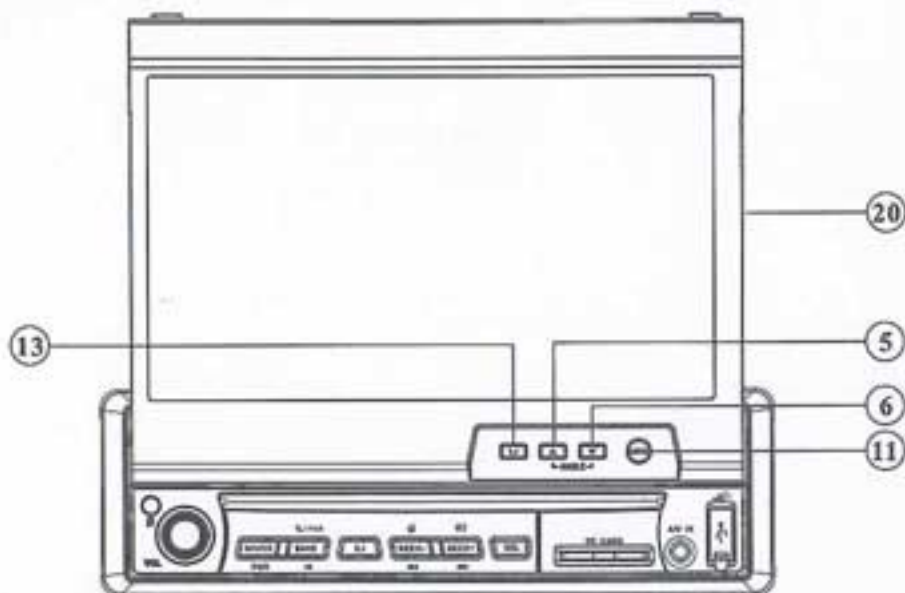

The Whole

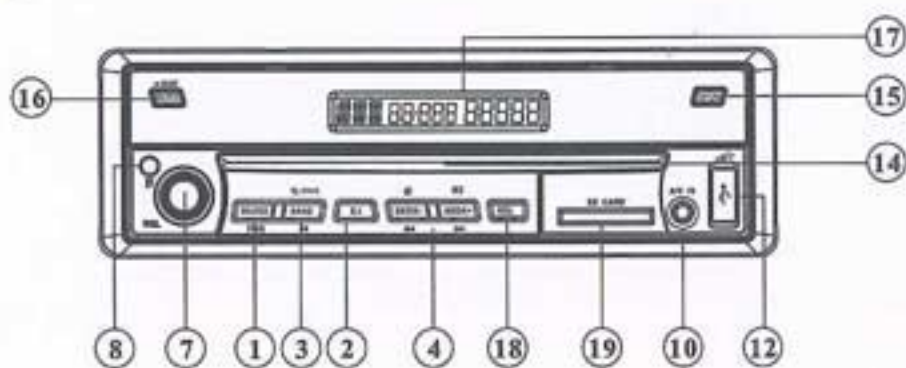

Before You Start

The Base

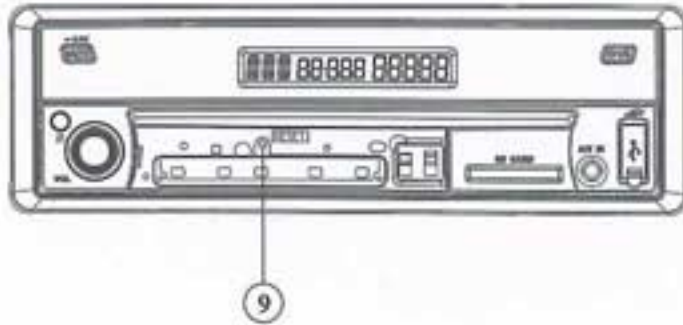

- ① SOURCE/PWR
Brief press to select radio mode or playback mode, hold and press it to turn the unit on or off.
- ② EJ Button
Press it to insert or eject a disc.
- ③ BAND/▶ / [📶 / PAIR] (band selector/play/pause/pair) Button
During radio mode, press it to select the bands;
During playback mode, press it to play or pause.
During bluetooth, press it to pair.
- ④ [SEEK- / ◀ / 📞] / [SEEK+ / ▶ / 📞] ([Adjust frequency backward/Previous/The last call, Answer a telephone] / [Adjust frequency forward/Next Track/Hangup, reject a call])
- ⑤ ▲ (ANGEL+) Button
- ⑥ ▼ (ANGEL-) Button
- ⑦ VOL+ / VOL- / SEL
- ⑧ REMOTE Infrared Sensor
- ⑨ RESET Button
- ⑩ A/V IN
- ⑪ (MENU) Button
During playback mode, brief press to set DVD menu; During radio mode, brief press it to set the radio menu, hold and press it to set the main menu.
- ⑫ USB Socket
- ⑬ ⏪ (Back Space) Button
- ⑭ Disc Loading Slot
- ⑮ OPEN Button
- ⑯ MUTE/NAV Button
- ⑰ LCD Screen
- ⑱ REL (release the front panel) Button
- ⑲ Common SD Card Slot
- ⑳ Navigation SD Card Slot



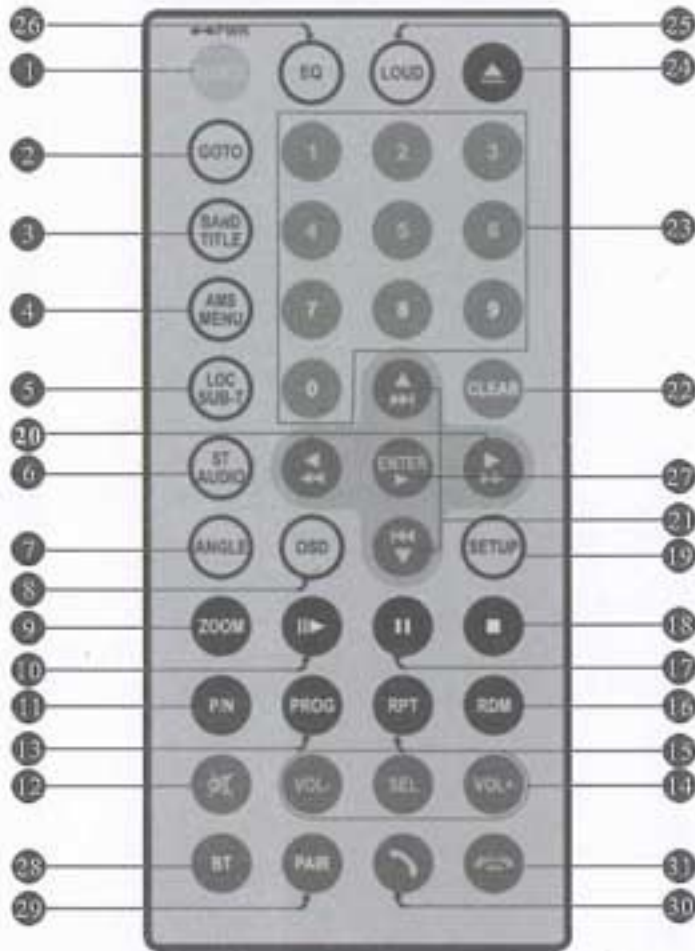







Remote Control



Tips:

For more information as to replacing battery, please refer to **Replacing the Battery** on page 6.

Before You Start

- ① SOURCE/PWR
- ② GOTO (playing time/track)
- ③ BAND/TITLE
- ④ AMS/MENU
- ⑤ LOC/SUB -T
- ⑥ ST/AUDIO (mono or stereo/language or channel selector)
- ⑦ ANGLE
- ⑧ OSD
Press it to show the current information.
- ⑨ ZOOM (to increase the picture)
- ⑩  (Slow Forward/Reward)
- ⑪ P/N(system adjusting)
- ⑫  Mute
- ⑬ PROG(Program playing)
- ⑭ VOL+/VOL-/SEL
- ⑮ RPT(Repeat Playing)
- ⑯ RDM (Playing Tracks at Random)
- ⑰  (Pause/Play)
- ⑱  (Stop Playing)
- ⑲ SETUP
- ⑳  (F.R/F.F)
- ㉑  (Previous/Next Track)
- ㉒ CLEAR
- ㉓ 0~9 (Number) Buttons
- ㉔  (Eject Button)
- ㉕ LOUD (loudness)
- ㉖ EQ (equalizer) Button
- ㉗  (Left/Right/Up/Down /ENTER)
- ㉘ BT (bluetooth mode) Button
- ㉙ PAIR
During bluetooth, press it to pair.
- ㉚  (Dial, last phone, answer a phone)
- ㉛  (Hang up/refuse a phone)

Before You Start

Specifications

General

Power Requirement	14.4V DC (11-16V allowable)
Load Impedance	4Ω
Max.Power Output	80W x 4
Tone Controls	±7dB Bass 100Hz Treble 10KHz
Dimensions	Approx.197x178 x 50 mm (d/w/h)
Weight	Approx.2.7kg

FM Section

Tuning Range (Optional)	87.5-108(MHz) (Europe) 87.5-107.9(MHz) (U.S.A.)
IF Range	10.7MHz
Usable Sensitivity (-30dB)	10dBuV
Signal-to-noise Ratio	50dB
Stereo Separation	30dB (1KHz)
Frequency Response	40Hz-12KHz

AM Tuner Section

Frequency Range (Optional)	522-1620(KHz) (Europe) 530-1710(KHz) (U.S.A.)
IF Range	450KHz
Usable Sensitivity (-20dB)	32dBuV

VCD/CD Player Section

VCD Signal System	AUTO/PAL/NTSC
Signal-to-noise Ratio	60dB
Separation	55dB(1KHz)
Distortion	0.3%

DVD Player Section

DVD Signal System	AUTO/PAL/NTSC
Channels	2
Frequency Response	40Hz to 16KHz
Signal-to-noise Ratio	60dB
Separation	60dB

Note:

Due to continuous product improvement, specifications and design are subject to change without prior notice.

Installation

Wiring Connection

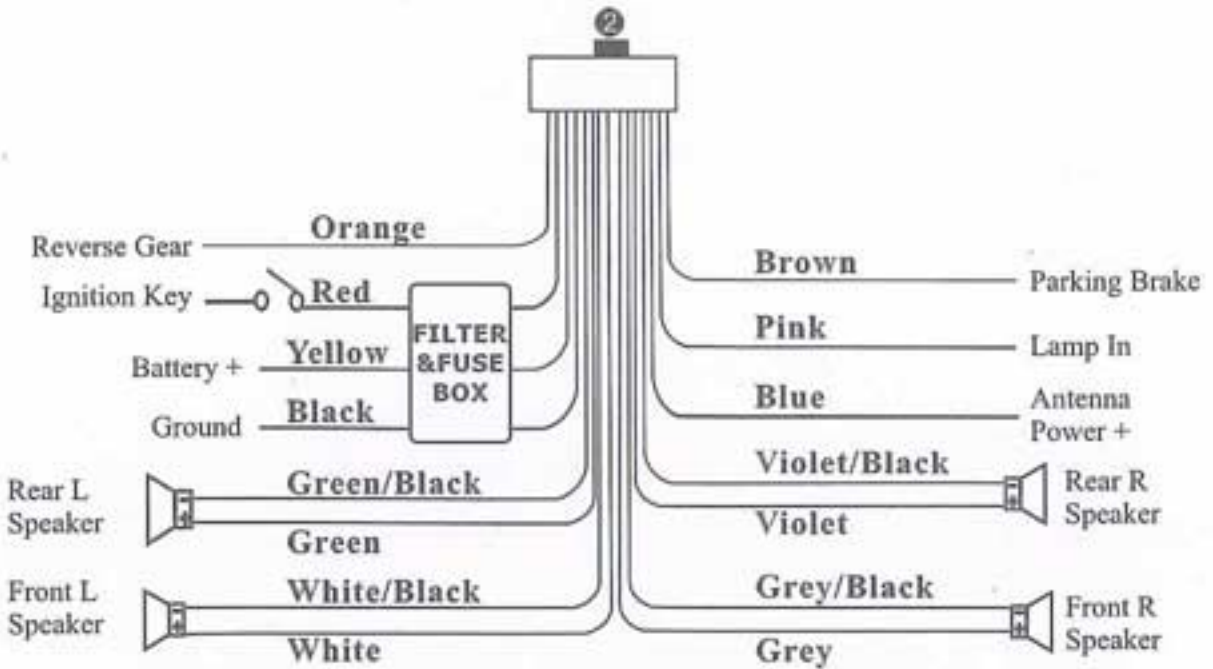
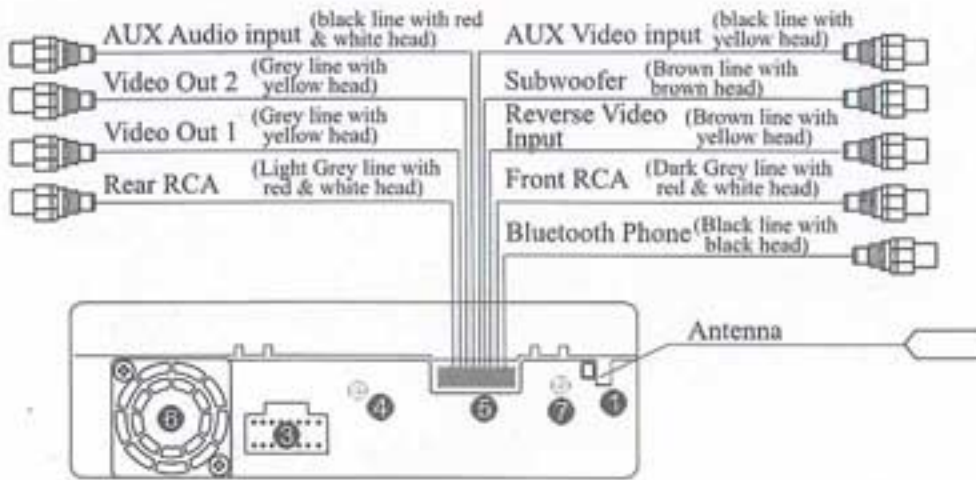

- ① Antenna Receptacle
- ② Output Plug(Male)
- ③ Output Socket(Female)
- ④ Screw Hole
- ⑤ Wire Clip
- ⑥ Fan Window
- ⑦ GPS Antenna Receptacle

Note:

- The brown wire is connected with brake signal; for safety, the programs can be seen on the monitor after braking the car, but the menu and RCA output are free of it. If you do not want to use this function, connect it with the negative pole.

Install the Unit

Main Parts List

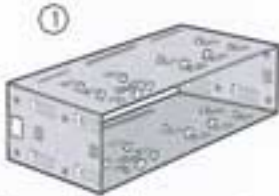

Mounting Sleeve x1



Rear Mounting Bolt x1



Harness Rubber x1



M4x3 & M5x5
4 Screws Each

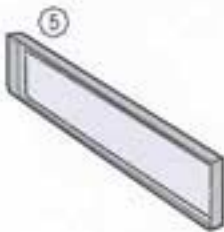

Outer Trim Frame x 1

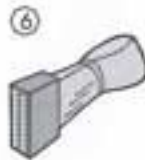

Connecting Wire x1



Steel Bar x 1

Installation Method ①: DIN Front-Mount

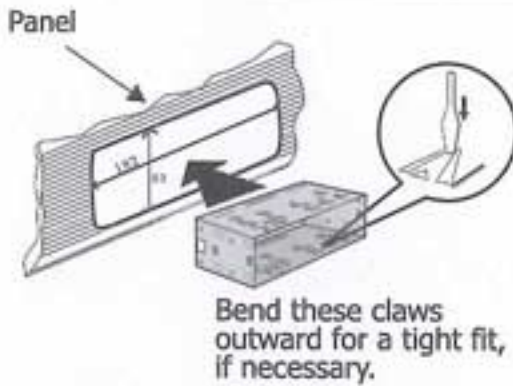

1

Install two M5x6 screws on both sides (left and right) of the lock hook brackets



①

2

Install the unit with four M2x2 screws

3

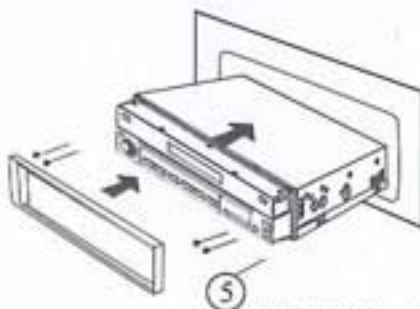

⑤

Install Outer Trim Frame

To support the unit

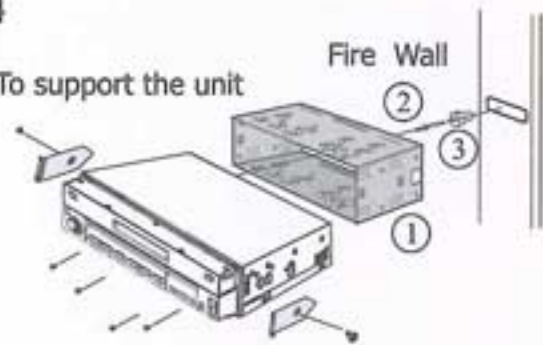

Fire Wall

②

①

③

Install the Unit

Installation Method

Installation using the screw holes at the sides of the unit.

Select a position where the screw holes of the mounting bracket supplied with the car and the screw holes of the main unit become aligned (are fitted), and tighten the screws (see ④ at 2 places on each side). And then fasten them to the car.

- Note:
Outer Trim Frame ⑤ and Mounting Sleeve ① are not used for installation method.

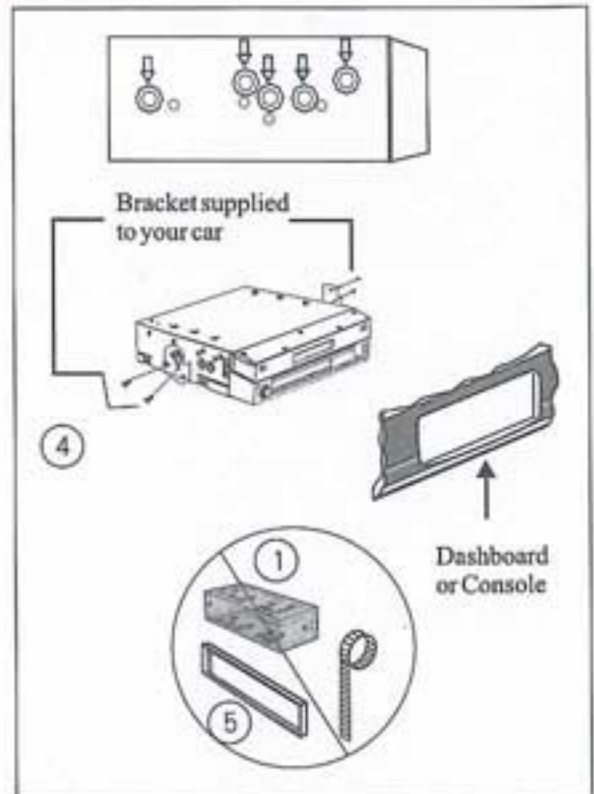

Detach the Unit

1. Remove the outer trim frame.

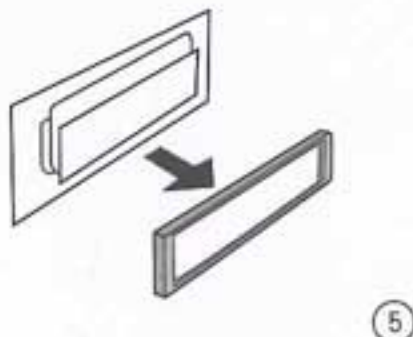

2. Screw the 4 screws, pull the head unit out.



Installation

Install the Front Panel

Put notch (A) (shown as picture) onto shaft (B). And then slightly press into the right side.

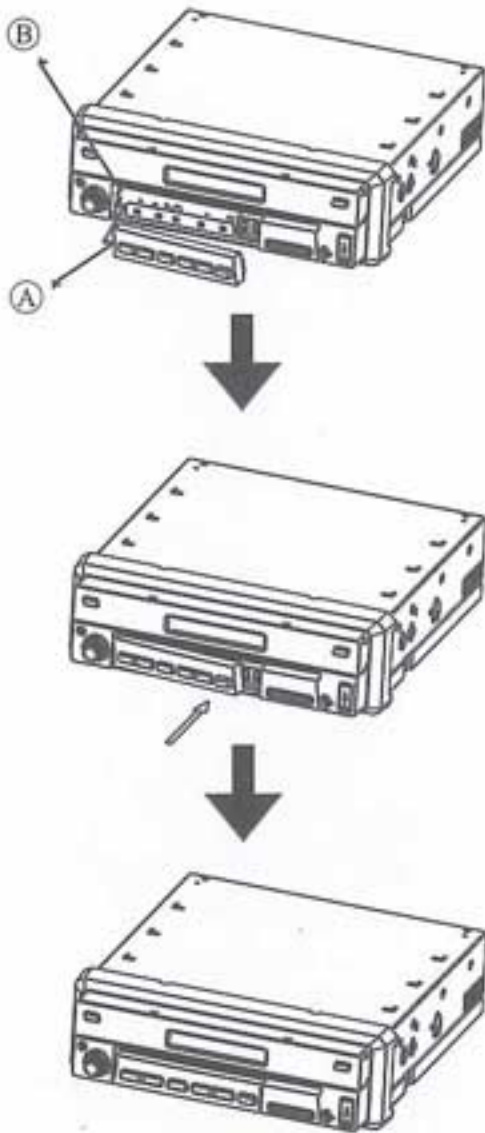

Detach the Front Panel

Press REL button in the upper rightcorner, and then the front panel will be folded down.

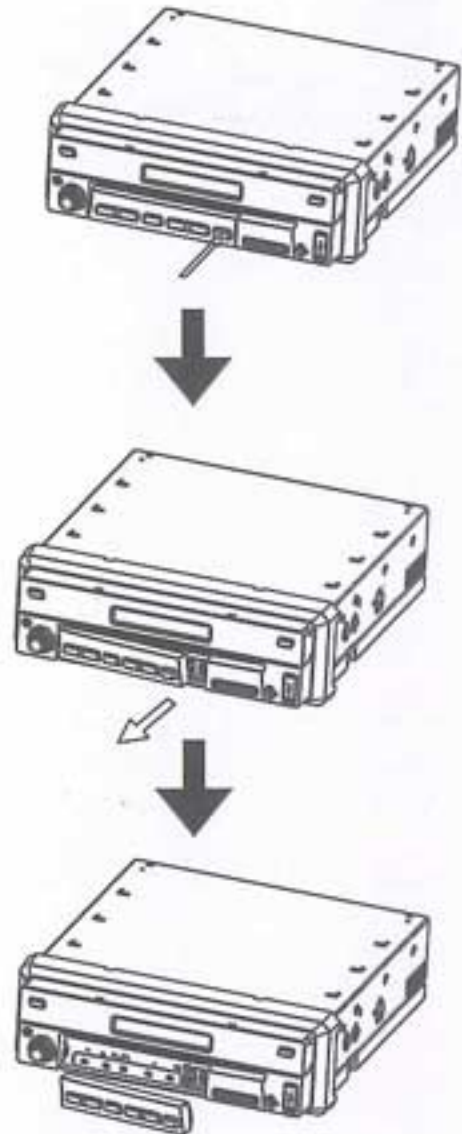

Common Operations

To Select Source by Menu

In any mode(except for DVD, SD, USB mode), press SRC, BACK/  in the monitor, the following menu will appear:



Press it to select your desired item.

If you want to use navigation feature, select (NAVI) from SOURCE menu or hold the MUTE/NAVI button  of front of the unit. For operating the navigation refer to IGO navigation manuel included with the unit. In any mode, press BACK to return to the previous mode.

Note:

- * If the font display in red, that means this function is null.

Reset the Unit

Operating the unit for the first time or after replacing the car battery, you must reset the unit.

Release the front panel at first, and then press  **RESET** button in the panel with a pointed object, (such as a ballpoint pen) to set the unit to initial status.

Note:

- * When some errors occur on the display, you can also press **RESET** button to resume to normal, and it will erase the clock setting and some memorized functions.
- * This function can only be operated by the main unit.



Turning the Unit On/Off

Briefly press  **PWR** button to turn on the unit, press it again, the unit is still in the waiting status. Press and hold to turn off.

Note:

- * Pressing PWR button on the main unit also performs the same function.

Volume Control

Press  **VOL+** button to increase the sound level and press  **VOL-** button to decrease the sound level.

Note:

- * Rotating  on the main unit also performs the same function.

Setting the Sound Characteristics

Repeatedly briefly press  **SEL** button to select the desired mode in the following order:

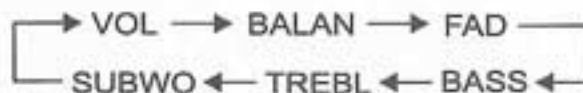

After selecting the desired mode, you can adjust the current level by pressing  **VOL** buttons.

Note:

- * Briefly press  button on the main unit also performs the same function.
- * During CD/MP3 mode, press SEL/-/+ in the monitor to performs the same function.

Common Operations

EQ Setting

While listening to the popular music, classic music or rock music, you can select the corresponding preset modes to adjust the sound quality perfectly by using **EQ** button.

Repeatedly pressing **EQ** button to choose the following modes in turn:

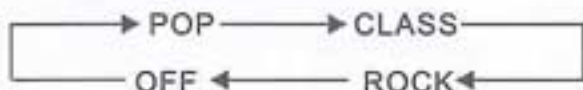

The default setting is OFF.

Note:

- * This function is only valid on remote control.

Turning Loudness On/Off

Press **LOUD** button activate loud function. You can press this button to increase the low frequency, which can improve sensitivity for your ears. Press it again to quit this function.

Note:

- * This function is only valid on remote control.

Eject a Disc

Press **EJ** button to eject or insert a disc.

Note:

- * Pressing **▲** on the remote control also performs the same function.

Insert a SD Card

Common SD Card: insert a common SD card into **SD** slot and the programs in the card will be played.

Navigation SD Card: insert a navigation SD card (is loaded with the navigation map into the SD card) into **SD** slot, otherwise this unit's NAVI does not work.

Mute Function

Press **MUTE** button to shut off the sound output. And “**MUTE**” appears on the LCD. Press it again to resume to previous volume level.

Note:

- * Briefly pressing MUTE on the main unit also performs the same function.

Mode Selector

Repeatedly briefly pressing **SOURCE** button to select the different modes available.

Note:

- * Briefly pressing SRC on the main unit also performs the same function.

Infrared Sensor:

Receptor **IR** on the main unit for the card remote control.

Dual Audio/Navigation Function

Listen to your audio while the navigation is on.

Press and hold the MUTE/NAV button **MUTE/NAV** of front of unit to activate the navigation while your audio is still playing.

Press and hold again the MUTE/NAV button **MUTE/NAV** will take you back to the previous audio channel.

Set up Main Menu

When the unit is on, the monitor will display the menu as follows:



Hold and press **SETUP** on the remote control or briefly press **MENU** on the main unit, or press **MENU** in the monitor to enter the menu as follows:



This menu includes **AUDIO**, **VIDEO**, **SOURCE**, **SYSTEM**, **EXIT**. Press them in the monitor to set the desired status.

1. Video Adjust

After selecting **VIDEO**, the sub menu will appear as follows:



In this menu you can adjust **CONTRAST**, **COLOR**, **TINT**, **BRIGHT**, **PICTURE**.

Picture Adjust

Press **PICTURE** in this menu, it will appear as follows:

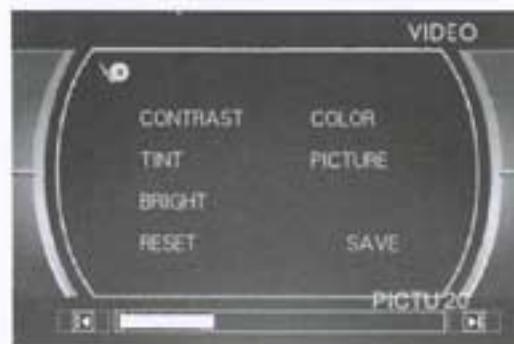

Press **◀** and **▶** to adjust the size, then press **SAVE** to save the setup, press **EXIT** to exit this menu.

Note:

- * Adjusting the other options perform the same operation.



2. Audio Adjust

After selecting AUDIO, the sub menu will appear as follows:



You can adjust VOLUME, SUBWOOFER, BALANCE, FAD, BASS, TREBLE. For example, press FAD, the setting menu will appear as follow:



Press  and  to adjust the desired FAD level, press EXIT to exit this menu.

Note:

- * Adjusting the other options perform the same operation.

3. Source Adjust

In the main menu, press SOURCE in the monitor, the sub menu will appear as follows:



You can adjust above items to ON or OFF, press the corresponding button to set.

If one of them was set OFF, that function is null. For example, to set the IPOD OFF, press SOURCE can not activate IPOD function. But can not set the current playback OFF.

If the item can not be set "ON", then this model does not contain this function.

4. System Adjust

After selecting SYSTEM, the sub menu will appear as follows:



In this menu you can adjust CLOCK SYSTEM, KEY BEEP, MONITOR FLEX and so on.

Main Menu

⌘ Clock System



Press **CLOCK SYSTEM** in the monitor to set **12 HOUR** or **24 HOUR** in this menu.

⌘ Next Setup

Press **+** to display the menu follows, press **+** to display the previous one.

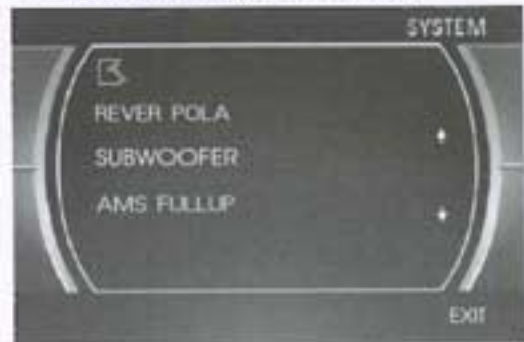

⌘ Key Beep



In this menu you can adjust **KEY BEEP**, press it in the monitor and select **ON** or **OFF**, the default setting is **ON**, it means when you press the keys, they sounded.

⌘ Reverse Pola



Setting **REVERSE POLA** in this menu. The signal is **+12V** when you back a car, please press **BATTERY** in the monitor; if the signal is **0V**, please press **GROUND**.

⌘ Monitor Flex



In this menu you can adjust **MONITOR FLEX**, press it in the monitor and select **MANUAL** or **AUTO**, the default setting is **AUTO**, it means the monitor will flex automatically.

⌘ Subwoofer

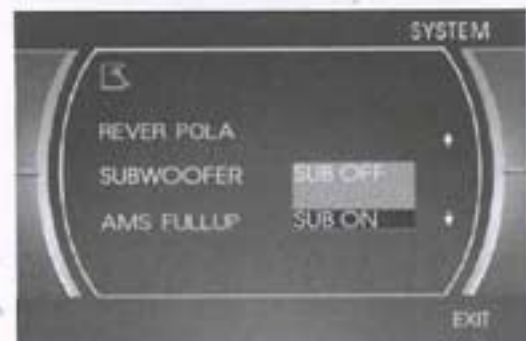

In this menu you can adjust **SUBWOOFER**, press it in the monitor and select **ON** or **OFF**, the default setting is **ON**.

Main Menu

AMS Fullup



In this menu to set the modes of AMS. When the setup is ON, the presettable stations are full, no new's is allowed. When you select OFF, it will searching continually.

Press \rightarrow to display the menu follows, press \leftarrow to display the previous one.



To set the above options as the same operation.

Local Area



You can select EUROPE or USA to search the stations quickly by your current area, also, you can select FM ONLY to receive the FM stations only.

Local



In this menu to search the LOCAL stations, when selected ON, the strong signal local stations can be received, when selected OFF, the weak signal out-of-town stations may be received.

Goto FREQ



To select ON, you can using GOTO button on the remote control to select a station's frequency directly in radio mode.

Main Menu



(Picture 1)

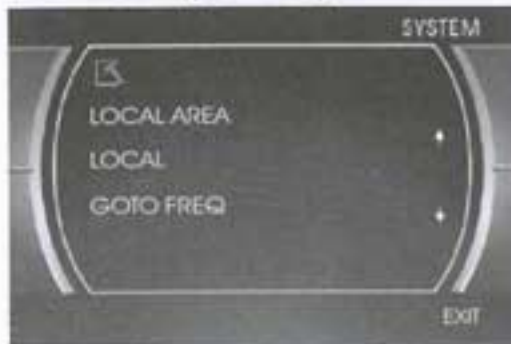

(Picture 2)

Press + in picture 1 or press + in picture 2 to enter the following menu:



Adjust Screen

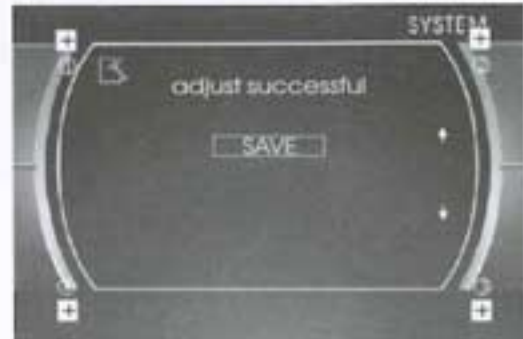

Press ADJ SCREEN to display the above menu, there are a square button in the top left corner. Press the square button at place ①, then the button will move to place ②, press it at place ②, it will move to place ③, then place ④, press SAVE at last.

Clock Adjust



Press CLOCK ADJ in the monitor to adjust the clock.

DVD/VCD/MP4

DVD/VCD/MP4 Setup

During DVD/VCD/MP4 playback, touch the screen the bottom shows the following menu:



	Play/pause
	Stop
	Decrease volume level
	Increase volume level
	DVD setup menu
	Mode selector

Note:

- * In above menu, press right screen repeatedly to play the next track(shows), press left to play the previous track(shows).

DVD/VCD/MP4 Play

Insert a disc into the slot , the unit will automatically switch on, if a disc is loaded, press SOURCE to start the playback. If the unit is in other menu, press DVD to switch to disc play.

Note:

- * Press SOURCE on the main unit to switch to DVD mode. When SD card and USB were inserted into, press this key again and again to switch among USB, SD card and disc.
- * Press in the monitor perform the same function.

Selecting Tracks Fast

During DVD/MP4 playback, press to play previous track, press to play next track.

During VCD playback, first press to return to the beginning of the current track, press again within 3 seconds to play previous track, press to play next track.

Note:

- * Pressing on the main unit or press left/right twice continuously in the monitor also perform the same function.

Number Buttons

Press one of Number Buttons(0~9) to select a track, it will be played automatically.

Note:

- * Press this region and the screen shows the following menu: number keys appears, touch the number to select tracks. Touch the " X " to exit this menu.

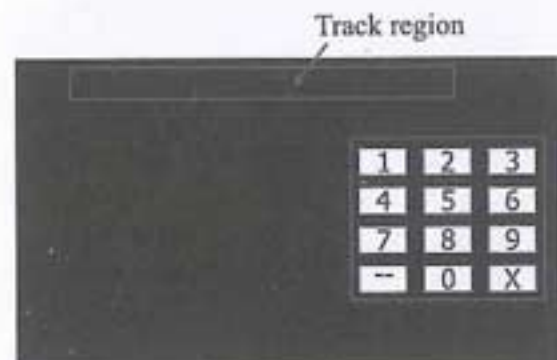

- * Press CLEAR to clear the mistake input.

Pause the Playback

During DVD/VCD/MP4 playback, press to switch between play and pause; During stop mode, press this button to resume playback mode.

Note:

- * Press in the monitor or on the main unit performs the same function.

Stop the playback

During DVD/VCD playback, first press, , then press or on the remote control to replay; press twice to stop playing completely, then press to return to the beginning of the current track. During MP4 playback, press first, then press to return to the beginning of the current track.

Note:

- * Press in the monitor perform the same function.

Playing Tracks at Random

During DVD/VCD/MP4 playback, press **Ⓚ** **RDM** button on the remote control to play any track at random under the directory which you select. Press it again to return to normal playing.

Note:

- * This function is operated by using the remote control.

Repeat Playing

During DVD playback, press **Ⓚ** **RPT** on the remote control to perform replaying function as followings:

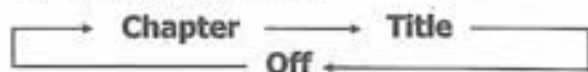

During VCD/MP4 playback, press **RPT** on the remote control to TRACK REPEAT.

Note:

- * This function is only valid on remote control.

Skip backward/forward/F.F /F.REW the playback

Press **Ⓚ** (**⏪** or **⏩**) on remote control to perform fast reward or fast forward. Each pressing will change as follow:



Note:

- * Press and hold **SEEK-**/**SEEK+** on the main unit also performs the same function.

System Switch

During DVD/VCD mode, Press **Ⓚ** **P/N** on remote control to set the TV standard to PAL or NTSC or AUTO system.

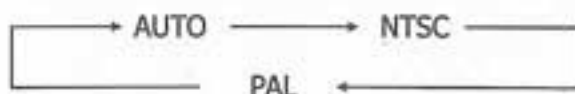

Note:

- * The function can be operated by selecting the DVD MENU SETUP.

Slow motion playback

During DVD mode, press **Ⓚ** **⏪** to slow play. There are speeds as follow:

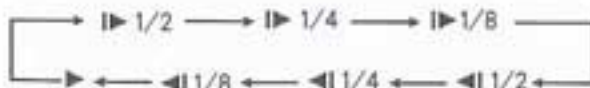

During VCD/MP4 mode, press **Ⓚ** **⏪** to slow play. There are speeds as follow:

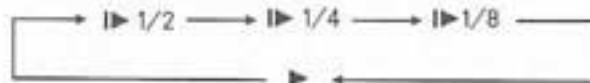

Note:

- * The function is only valid on remote control.

Increase the size of picture

During DVD/VCD/MP4 mode, Press **Ⓚ** **ZOOM** to increase the picture in size. There are sizes as follow, Each pressing increases the size until the maximum size is reached.

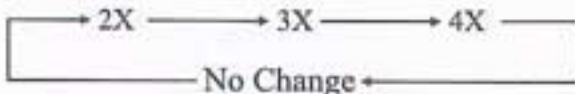

Note:

- * The function is only valid on remote control.
- * To remove the image by pressing **Ⓚ** button.

On Screen Display

During DVD status, press **Ⓚ** **OSD** button the display shows:

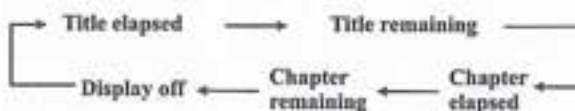

DVD/VCD/MP4

During VCD status, press **OSD** button the display shows:

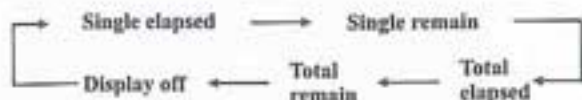

During MP4 status, press **OSD** button the display shows:

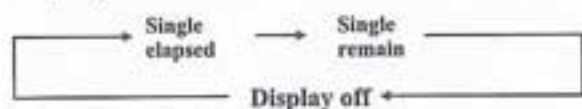

Note:

- * This function is operated by using the remote control.

Setting the Playback Time

During DVD mode, press **GOTO** button to set the playing time, when the TFT display : *title/chapter/audio/subtitle/angle /title time/chapter time/repeat/time disp.* Press **[▲]** **[▼]** to select the options, press **ENTER** to set the status. Then press **NUMBER BUTTONS** or **[▶]** **[◀]** to set the current status.

During VCD mode, press **GOTO** button to set the playing time, when the TFT display : *track/disc time/track time/repeat /time disp.* Press **[▲]** **[▼]** to select the options, press **ENTER** to set the status. Then press **NUMBER BUTTONS** or **[▶]** **[◀]** to set the current status.

During MP4 playback, first press **GOTO**, and monitor shows : —, press your desired track by using number buttons and press **ENTER** to set the status. Second press **GOTO** button, and the monitor shows: -:—:—, input your desired time, then press **ENTER**.

Note:

- * This function is operated by using the remote control.
- * Press **CLEAR** to clear the mistake input.

Changing audio language (Multi-audio)

DVDs can provide audio playback with different language. With DVDs featuring multi-audio recordings, you can press **AUDIO** to switch between language and audio systems during playback.

Selection options switch as follows:

AUDIO 1 — AUDIO 2 — AUDIO 3.....

Note:

- * This function is operated by using the remote control.
- * This function only operates with DVDs featuring multi-audio recordings.
- * The number in the “**ⓐ**” mark on a DVD's package indicates the number of recorded languages/audio systems.

Changing the subtitle language (Multi-subtitle)

With DVDs featuring multi-subtitle recordings. You can press **SUB-T** to switch between subtitle languages during playback. Selection options switch as follows:

Subtitles 1 — Subtitles 2 — — Subtitles OFF

Note:

- * This function is operated by using the remote control.
- * The number in the “**ⓐ**” mark on a DVD's package indicates the number of recorded subtitle languages.

Changing the viewing angle (Multi-angle)

With DVDs featuring multi-angle (scenes shot from multiple angles) recordings, you can press **7 ANGLE** to switch among viewing angles during playback.

Selection options switch as follows:

ANGLE 1 — ANGLE 2 — ANGLE 3.....

■ Notes:

- * This function is operated by using the remote control.
- * This function only operates with DVDs featuring multi-angle recordings.
- * The "Ⓜ" mark on a DVD's package indicates it features multi-angle scenes. The number in the "Ⓜ" mark indicates the number of angles from which scenes were shot.
- * It is invalid to pressing ANGLE during fast forward/fast reverse or pause.

Selecting Channel

During VCD status, repeatedly press **6 AUDIO** button to select the following channel:



Selecting the corresponding channel to set the different sound characters.

■ Note:

- * This function is operated by using the remote control only.

Program Playing

During VCD mode, press **18 PROG**, the TFT displays the program menu. Press **NUMBER BUTTONS** to select the track Number and then press **27** to move the cursor to **START**, press **ENTER** to start program playing; move the cursor to **EXIT** and press **ENTER** to exit the program playing. Move the cursor to **⏮** and press **ENTER** to the previous page; move the cursor to **⏭** and press **ENTER** to the next page. During this process, press **18** **■** to cancel the program playing.

■ Note:

- * The function is only valid on remote control.
- * Press **22 CLEAR** to clear the mistake input.

Playing PBC (Menu)

During VCD status, first press **3 TITLE**, PBC playback starts and the menu of entire disc appears on the monitor, and then you can select your favorite track by using **28 Number Buttons**. When a track is playing, you can press **4 MENU** to return to the menu if you would like to end the track and select others. To cancel PBC playing, press **3 TITLE** button again.

■ Note:

- * This function is operated by using the remote control.
- * **PBC** playing confirms to version 2.0 of VCD and SVCD disc only.

DVD/VCD/MP4

Selecting MENU

- 1 **Selecting Menu:** During DVD status, press **MENU** to return to the root menu, all of the chapters will appear on monitor. You can press **27** or **28** button to select your desired chapter.
- 2 **Selecting Title:** During DVD status, press **TITLE** to return the title menu, all of the titles will appear on monitor. You also can press **27** or **28** button to select your desired chapter.

Note:

- * Under DVD menu, touch the screen to select items.
- * If the touch menu options invalid or the disc does not support touch-TITLE, **+** that is the same as **27** buttons on the remote control will display on the screen. Press **←** to left, press **→** to right, press **▲** to up, press **▼** to down * and press **●** to ENTER.

DVD SETUP MENU

Press **SETUP** on remote control or **MENU** on the main unit or **□** in the monitor, main menu and sub-menu will appear on TFT, pressing **27** [**▲**] [**▼**] [**▶**] [**◀**] on the remote control to select your desired items, then press ENTER.

Press **▲** to the pervious one, press **SETUP** or press [**▲**] [**▼**] [**▶**] [**◀**] to move the cursor on "×", then press ENTER to exit the menu setup.

Notes:

- * The selections are the preferred options that will be chosen if they are available on a disc. If the disc that is inserted does not have the preferred option then the discs own preference will be used.
- * Regarding **SETUP MENU**, please refer to the following pages for more details.
- * Some functions varies depending on the types of models or formats of the disc.
- * To touch the screen to select menu, touch it again to select the item.

--General Setup Page--**Angle Mark**

Example showing how to set picture mode:

(Press ▲ or ▼)

--General Setup Page--

DISPShape	Wide
Angle Mark	On
OSD Lang	Eng
Captions	Off
Screen Saver	On

Go To General Setup Page



(Press ►, ▲ or ▼, then press ENTER)

--General Setup Page--

DISPShape	Wide	
Angle Mark	On	On
OSD Lang	Eng	Off
Captions	Off	
Screen Saver	On	

Set Angle Mark

OSD Lang

Example showing how to set language mode:

(Press ▲ or ▼)

--General Setup Page--

DISPShape	Wide
Angle Mark	On
OSD Lang	Eng
Captions	Off
Screen Saver	On

Go To General Setup Page



(Press ►, ▲ or ▼, then press ENTER)

--General Setup Page--

DISPShape	Wide	
Angle Mark	On	
OSD Lang	Eng	English
Captions	Off	
Screen Saver	On	

Set OSD Language

--General Setup Page--

Captions

Example showing how to set captions on/off:

(Press ▲ or ▼)

--General Setup Page--

DISP Shape	Wide
Angle Mark	On
OSD Lang	Eng
Captions	Off
Screen Saver	On

Go To General Setup Page



(Press ►, ▲ or ▼, then press ENTER)

--General Setup Page--

DISP Shape	Wide	
Angle Mark	On	
OSD Lang	Eng	
Captions	Off	On
Screen Saver	On	Off

Closed Captions

Screen Saver

Example showing how to set Screen Saver on/off:

(Press ▲ or ▼)

--General Setup Page--

DISP Shape	Wide
Angle Mark	On
OSD Lang	Eng
Captions	Off
Screen Saver	On

Go To General Setup Page



(Press ►, ▲ or ▼, then press ENTER)

--General Setup Page--

DISP Shape	Wide	
Angle Mark	On	
OSD Lang	Eng	
Captions	Off	
Screen Saver	On	On
		Off

Screen Saver

--Dolby Digital Setup--**Dual Mono**

Example showing how to set stereo mode:

(Press ▲ or ▼)

--Dolby Digital Setup--



(Press ►, ▲ or ▼, then press ENTER)

--Dolby Digital Setup--

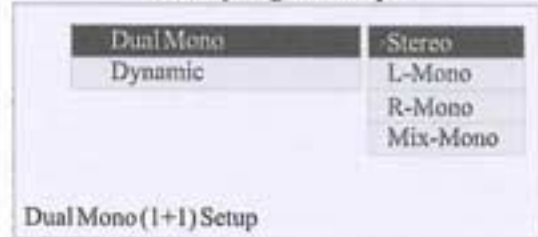
**Dynamic**

Example showing how to set dynamic range compression:

(Press ▲ or ▼)

--Dolby Digital Setup--

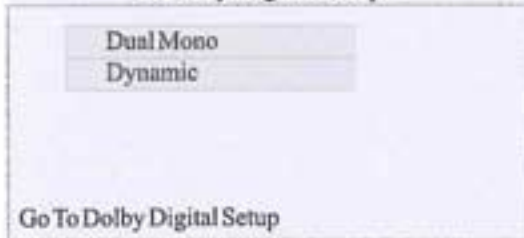

(Press ►, ▲ or ▼, then press ENTER)

--Dolby Digital Setup--

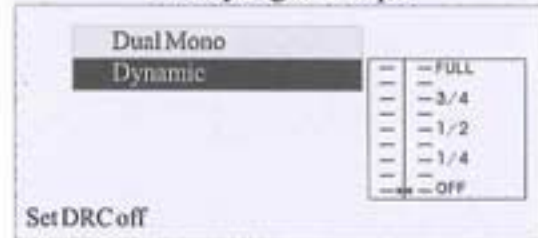

DVD/VCD/MP4

---Preference page---

Audio

Example showing how to set Audio language:

(Press ▲ or ▼)

--Preference Page--

DISPType	Auto
Audio	Eng
Subtitle	Eng
Disc Menu	Eng
Parental	
Password	
Default	

Go To Preference Page



(Press ► , ▲ or ▼ , then press ENTER)

--Preference Page--

DISPType	Auto	English
Audio	Eng	French
Subtitle	Eng	Spanish
Disc Menu	Eng	Chinese
Parental		Japanese
Password		Korean
Default		Russian
		Thai

Preferred Audio Language

Subtitle

Example showing how to set subtitle language:

(Press ▲ or ▼)

--Preference Page--

DISPType	Auto
Audio	Eng
Subtitle	Eng
Disc Menu	Eng
Parental	
Password	
Default	

Go To Preference Page



(Press ► , ▲ or ▼ , then press ENTER)

--Preference Page--

DISPType	Auto	English
Audio	Eng	French
Subtitle	Eng	Spanish
Disc Menu	Eng	Chinese
Parental		Japanese
Password		Korean
Default		Russian
		Thai

Preferred subtitle Language

---Preferences page---

Disc Menu

Example showing how to set Disc Menu Language:

(Press ▲ or ▼)

--Preference Page--

DISPType	Auto
Audio	Eng
Subtitle	Eng
Disc Menu	Eng
Parental	
Password	
Default	

Go To Preference Page



(Press ►, ▲ or ▼, then press ENTER)

--Preference Page--

DISPType	Auto	English
Audio	Eng	French
Subtitle	Eng	Spanish
Disc Menu	Eng	Chinese
Parental		Japanese
Password		Korean
Default		Russian
		Thai

Preferred Menu Language

Parental

Example showing how to set parental control:

(Press ▲ or ▼)

--Preference Page--

DISPType	Auto
Audio	Eng
Subtitle	Eng
Disc Menu	Eng
Parental	
Password	
Default	

Go To Preference Page



(Press ►, ▲ or ▼, then press ENTER)

--Preference Page--

DISPType	Auto	2	G	▲
Audio	Eng	3	PG	
Subtitle	Eng	4	PG 13	
Disc Menu	Eng	5	PGR	
Parental		6	R	
Password		7	NC 17	
Default		8	Adult	
			Off	

Set Parental Control

Password

Example showing how to set password, and the default password is 8888.

(Press ▲ or ▼)

--Preference Page--

DISPType	Auto
Audio	Eng
Subtitle	Eng
Disc Menu	Eng
Parental	
Password	
Default	

Go To Preference Page



(Press ►, ▲ or ▼, then press ENTER)

--Preference Page--

DISPType	Auto	
Audio	Eng	
Subtitle	Eng	
Disc Menu	Eng	
Parental		
Password		Change
Default		

Change Password

---Preferences page---

Default Example showing how to set load factory setting:

(Press ▲ or ▼)

--Preference Page--

DISPType	Auto
Audio	Eng
Subtitle	Eng
Disc Menu	Eng
Parental	
Password	
Default	

Go To Preference Page

→

(Press ► , ▲ or ▼, then press ENTER)

--Preference Page--

DISPType	Auto
Audio	Eng
Subtitle	Eng
Disc Menu	Eng
Parental	
Password	
Default	Reset

Load Factory Setting

CD/MP3/SD/USB Setup

During CD playback, touch the screen shows the following menu:



During MP3/SD/USB playback, touch the screen shows the following menu:

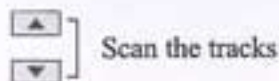

Scan the tracks

CARD To show SD card or USB

SEL Sound characteristics

- Decrease volume level, adjust some items

+ Increase volume level, adjust some items

Play/Pause Play/pause

Stop Stop

Previous track Previous track

Next track Next track

DVD setup menu DVD setup menu

MODE Mode selector

Track Region: Press this region and the screen shows the following menu: number keys appears, touch the number to select tracks. Touch the "X" to exit this menu.



CD/MP3/SD/USB Play

Insert a CD/MP3 disc into the slot, the unit will play automatically.

Take away the rubber plug ⑫ USB or ⑬ SD card, then insert USB or SD card which will be played automatically.

If there have be loaded a disc/USB/SD card, press SOURCE to switch to play, or back to play source to select menu, press DVD to play.

Note:

- Press SOURCE on the main unit to switch to DVD mode. When SD card and USB were inserted into, press this key again and again to switch among USB, SD card and disc.
- Press MODE to turn to mode switch.

Selecting Tracks Fast

During MP3/SD/USB playback, press ④ ⏪ to play previous track, press ④ ⏩ to play next track.

During CD playback, first press ④ ⏪ to return to the beginning of the current track, press ④ ⏪ again within 3 seconds to play previous track, press ④ ⏩ to play next track.

Note:

- Press ④ ⏪/⏩ button on the main unit or **⏪** and **⏩** in the monitor perform the same function.
- In CD/MP3/SD/USB mode, you can press track's Number or name to play.

CD/MP3/SD/USB

Repeat Playing

During CD/MP3/SD/USB playback, press **RPT** to replay the current track, press it again to cancel this function.

Note:

- * This function is operated by using the remote control.
- * The default setting is Disc Repeat.

Number Buttons

Press one of **Number Buttons(0~9)** to select a track to play automatically.

Note:

- * Press track region and the screen shows the number keys, touch the number to select tracks.
- * Press **CLEAR** to clear the mistake input.

Selecting Track

During CD playback, first press **GOTO**, and TFT shows : *disc go to:--:--*, press your desired time of the playback by using number buttons.

Second press **GOTO** button, *track go to:--:--* appears on TFT, also input your desired numbers to play the current time of your selection.

During MP3/SD/USB mode, first press **GOTO** and the TFT shows:---. Then press **NUMBER BUTTONS** to input the MP3/SD track's Number to play it; secondly press **GOTO** button, and the TFT shows : --:--, now input the desired time to play the current track at this point.

Note:

- * This function is operated by using the remote control.
- * Press **CLEAR** to clear the mistake input.

Stop Play

During CD/MP3/SD/USB playback, Press **STOP** to stop the playback.

Note:

- * Press **STOP** in the monitor perform the same function.

Playing Tracks at Random

During CD/MP3/SD/USB playback, press **RDM** button on the remote control to play any track at random under the directory which you select. Press it again to return to normal playing.

Note:

- * This function is operated by using the remote control.

Pause the Playback

During CD/MP3/SD/USB playback, Press **PAUSE** to switch between play and pause.

Note:

- * Press **PAUSE** in the monitor or **PAUSE** on the main unit performs the same function.

Skip backward/forward/F.F /F.REW the playback

Press **SKIP** (**FF** or **REW**) on remote control to perform fast reward or fast forward.

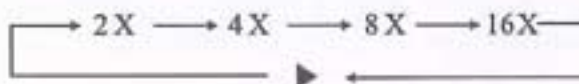

Note:

- * Press and hold **SEEK+/SEEK-** on the main unit also performs the same function.

Slow motion playback

During MP3/SD/USB mode, press **⏪** to slow forward. There are speeds as follow:

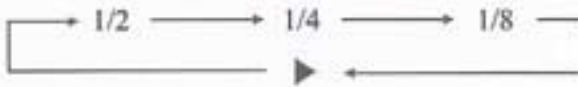

Note:

- * This function is operated by using the remote control.

On Screen Display

During CD status, press **OSD** button the display shows:

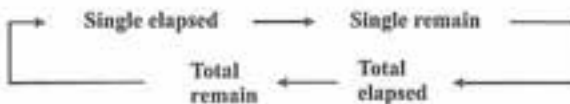

Note:

- * This function is operated by using the remote control.

Program Playing

During CD mode, press **PROG**, the TFT displays the program menu. Press **NUMBER BUTTONS** to select the track Number and then press **⏪** to move the cursor to **START**, press **ENTER** to start program playing; move the cursor to **EXIT** and press **ENTER** to exit the program playing. Move the cursor to **⏪** and press **ENTER** to the previous page; move the cursor to **⏩** and press **ENTER** to the next page. During this process, press **⏹** to cancel the program playing.

Note:

- * The function is only valid on remote control.
- * Press **CLEAR** to clear the mistake input.

Eject SD Card

Push SD card to eject it.

During SD playing mode, to eject SD card to switch to Disc mode; if there is no disc in the main unit, it will switch to USB mode, or else, it will switch to Radio mode.

During other modes, to eject SD card to keep the previous mode.

Eject USB

Pull USB to eject it.

During USB playing mode, to eject USB to switch to Disc mode; if there is no disc in the main unit, it will switch to SD Card mode, or else, it will switch to Radio mode.

During other modes, to eject USB to keep the previous mode.

Tuner

Listening to the radio



- 1 **Band Indicator**
Shows which band the radio is tuned to.
- 2 **Preset Number Indicator**
Shows what preset has been selected.
- 3 **Frequency Indicator**
Shows which frequency the tuner is tuned.
- 4 **SEEK+/SEEK-**
Briefly press to tune by the preset table range, hold and press to tune automatically.
- 5 **The 6 stations of the current band.**
Briefly press to select station, hold and press to save the current station to one of the 6 stations.
- 6 **BAND**
To select the bands.
- 7 **BT**
Press to enter into bluetooth mode.
- 8 **MENU**
Press it to enter MAIN MENU.
- 9 **SRC**
Press this button to select the signal source.
- 10 **AMS**
Press to scan the current station and tune automatically.

Band Selector

During radio status, repeatedly press 5 BAND button to select bands in the following order:

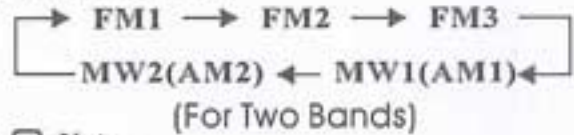

Note:

- * Press BAND on the main unit or 6 in the monitor performs the same function.

Manual/Automatic Tuning

Manual Tuning: Briefly press 20 (▶▶ or ◀◀) button on the remote control to select the different band.

Automatic Tuning: Press and hold 20 (▶▶ or ◀◀) button the radio automatically searches a station downward or upward respectively and plays when it finds a station.

Note:

- * Press 4 in the monitor or SEEK+/SEEK- on the main unit also performs the same function.

DX/LOC Selector

During radio status, press 5 LOC button to select strong or weak station reception. "LOC ON" appears on the display and only local station is available. when it disappears both distance and local stations can be received.

Note:

- * The function is only valid on remote control.
- * The function is invalid in AM tuning.

Selecting the Stored Station

During radio status, press 27 ▲ button to select the stored station upward, press ▼ to select the stored station downward.

Note:

- * The function is only valid on remote control.

MO/ST Selector

During radio status, you can press **ST** button on the remote control to select MONO mode or STEREO mode.

Stereo reception is changed when "STEREO" appears.

It is switched to MONO mode when "MONO" appears.

Note:

- * It is only valid on remote control.
- * Switch to MONO compulsively to improve the listening quality when weak signal.
- * It is only valid in FM tuning.

Scanning/Memorizing Stations Automatically

During radio status, briefly press **AMS** button on the remote control to scan each stored station 6 seconds respectively which stored in **Number Buttons** (from 1 to 6). You can press the corresponding **Number Buttons** or **AMS** button when your desired station is charged. And it starts playing that station.

When press and hold **AMS** button, it will activate automatically memory storing function. The radio automatically selects a station and has it stored in any one of the **Number Buttons (from 1 to 6)**.

Note:

- * The unit can be stored up to 6 stations for each band.
- * Press **INFO** in the monitor performs the same function.

On Screen Display

During radio status, press **OSD** to display the edition information.

Note:

- * It is only valid on remote control.

Goto FREQ

Press **GOTO**, and the monitor shows: FREQ, then press the Number to input the valid frequency, then the TV program will be played.

Note:

- * It is only valid on remote control.
- * It is only valid when GOTO FREQ is on in main menu.

Number Buttons

During radio status, press **Number Buttons** to receive the stored stations.

During radio status, **Number Buttons (from 1 to 6)** can help you store your favorite station. You can follow the steps as below:

- 1 When receiving a station, press and hold any one of the **Number Buttons (from 1 to 6)** until the number appears on the LCD, which indicates that station is already stored in the corresponding number button.
- 2 Press and hold **AMS** button to receive stations automatically, and store them in 1 to 6 number respectively.
- 3 Press and hold another number button more than 2 seconds when listening in a station in one number button's, the station will be stored in that number button.

Note:

- * Press **INFO** in the monitor performs the same function.

AUX Touch Screen Menu

Press SRC to turn to AUXF SET:

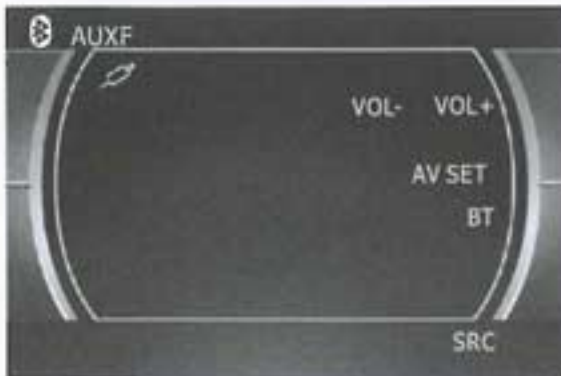

Press SRC again to turn to AUXR SET:

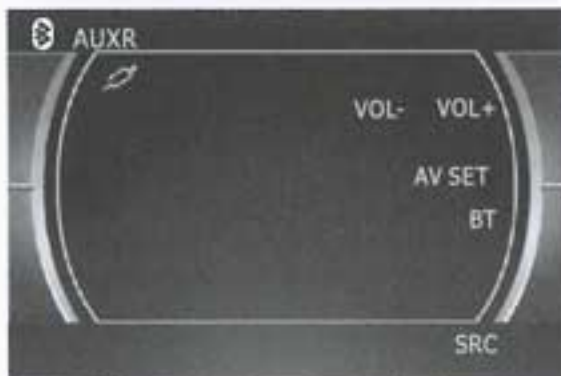

In AUX mode, select AV SET:



AV SET

For more details to adjust AUDIO, VIDEO and SYSTEM (Auto 1: PAL, NTSC, SECAM), (Auto 2: P-M, P-N). To adjust AUDIO and VIDEO please refer to pages 18 to 19.

VOL- To decrease the volume

VOL+ To increase the volume

←→ Mode selector

Bluetooth

Bluetooth Operational Interface

Press **BT** on the remote control or **BT** in the monitor to open the bluetooth operational interface:



1 **Number Buttons**

To input the phone number.

2 **Dial, last phone, answer a phone.**

3 **Hang up, refuse a phone.**

4 **Number Show**

5 **PAIR**

6 **ACH (audio change)**

Note:

- * Some of phone can just switch the audio from the unit to the phone.

7 **POWER**

Press it to turn on or turn off the bluetooth function.

8 **C (clear)**

9 **BACK**

Using a Bluetooth Wireless Connection

The device can be dialed wirelessly in bluetooth status. Before using the bluetooth function, please turn on your cellphone bluetooth function.

Note:

- * To provide the best sound without or little distorted sound (the cellphone or network brings).
- * Full duplex conversation.
- * Bluetooth ver2.0 compliant.
- * Please dial-up the device before connecting bluetooth.

Pairing Your Unit and Bluetooth Phone

The device supports handsfree profile, head-set profile, A2DP (Audio Advanced Distribution profile) and AVRCP (Audio Video Remote Control profile). Follow the pairing instruction for the first time use, after that the unit will connect automatically.

Pairing in Handsfree Mode

1. Press **PAIR**, and *PAIRING* shows on the screen.
2. To get into *CELLPHONE CONNECTION* to search fixtures;
3. If the cellphone has connected, *PAIR SUCCESS* appear and then *CONNECT* in order, **BT** will from blue to red.

Note:

- * Pressing **PAIR** on the main unit or **5** in the monitor also performs the same function.



Bluetooth

Cellphone Pairing Mode

1. Browse your cellphone menu and find the connectivity or Bluetooth connection section.
2. Select *search for* a new handsfree device function and allow the phone to find the **mobile**.
(Different cellphone has different bluetooth menu, please refer to your phone manual.)
3. When CAR A/V DEVICE appear, select this item.
(if it can not be connected, please refer to mobile manual, and connect it again.)
4. To input the password, the password is: 1234.
5. Press the connect with the Handsfree option on your cellphone, and **CONNECTED** appears.

Bluetooth Connection and Disconnection



When established bluetooth connection between this unit and the cellphone, bluetooth icon  on the display appears in red.

Press  PAIR to turn off bluetooth connection, and  appears in blue.

Press , **PAIR SUCCESS** appear on the display, then display shows **CONNECTED** when bluetooth connected; display shows **PAIRING TIME OUT**, when bluetooth disconnected.

Note:

- * Please keep the phone battery is full of power, or else the bluetooth connection will be disturbed.
- * To ensure connection succeed
---Please delete menu of cellphone with bluetooth.
---Please reset the unit and cellphone.
---Please reset every step of pairing.
- * Disconnect after pairing
---Please pair the phone in manual.
For example: pairing fixture → cellphone → connect.

- * Pressing PAIR on the main unit or  in the monitor also performs the same function.
- * Pressing  in the monitor to turn off the bluetooth function.

Using the Unit as a Handsfree Device





When the unit is ringing, then it appears call from and the phone number ID***** on the dialing,

To accept call: Press  to answer a call, it appears **PICK UP** on the display.



To reject call: Press  to reject a call, it appears **REJECT** on the display.

To end call: Press  to end call, and **HANG UP** appears on the display.



Note:

- * Some of cellphones do not support reject call during bluetooth mode.
- * Press  and  on the unit or  and  in the monitor performs the same function.

Last Number Dialing

Press  button, it appears last call number on , press  again, and then **PICK UP** appears on the display during conversation.

Note:

- * Press  on the unit or  perform the same function.
- * To dial the number of the unit in the car only.

To Dial by Cellphone

1. The unit activated automatically when you make a call by cellphone, and **DIAL OK** appears.
2. When you receive a call, **PICK UP** appears on the display.

To Dial by the Unit

when cellphone is connected, press **25** to input the call number, then press **30** to dial, *DIAL OK* appears, when the call is pick up, and it appears *PICK UP*.

▣ Note:

- * Press **22** CLEAR or **38** in the monitor to delete wrong inputs.
- * Press **2** on the unit or **2** perform the same function.

Using the Unit as Bluetooth Music

During bluetooth mode, the musics on the cellphone switch to the unit for play.

To select music fast: press **21** **⏮** to play the previous track, press **21** **⏭** to play the next one.

Pause play: press **17** **⏸** to pause play.

Stop play: press **18** **■** to stop play, and press the PLAY to play the current track again.

▣ Note:

- * The function is only valid on remote control.

Audio Transfer between the Unit and Phone

Press **6** to change the conversation from the unit to the cellphone.

▣ Note:

- * The function will be cause to be disconnected bluetooth link for some phones, but you do not worry just press **6** button while private conversation with some phones, then switch back to the unit automatically.
- * The function just only can be changed the conversation from the unit to the cellphone with some phones, not to back the unit.

Additional Information

Simple Troubleshooting Guide

The following checklist might help to solve the problems which you meet when using the unit. Please double check and make sure if the connection and the procedure of the operation is properly before using the checklist below.

Problem	Cause/Solution
No power.	<ul style="list-style-type: none"> • Check and make sure whether the fuse is blown, replace with the proper value if necessary.
Some errors occur in the LCD or no function when pressing the button.	<ul style="list-style-type: none"> • Press RESET button.
Unable to receive stations.	<ul style="list-style-type: none"> • Check and make sure whether the antenna is inserted or the antenna is properly connected, if not, insert the antenna or connect it properly.
Poor effect on receiving a station.	<ul style="list-style-type: none"> • Antenna may not be the proper length. Make sure the antenna is fully extended; if broken, replace the antenna with a new one. • The antenna is poorly grounded, check and make sure the antenna is properly grounded at its mounting location.
CDs cannot be loaded.	<ul style="list-style-type: none"> • A CD is loaded in the mechanism.
Sound skips.	<ul style="list-style-type: none"> • The CD is dirty or damaged.
No images.	<ul style="list-style-type: none"> • The Video line from main unit to the TV is not connected properly.
Images skip.	<ul style="list-style-type: none"> • Improper setting of the color system. Set the color system to "PAL" or "NTSC" according to the connected television.

Note:

If any of the problem persist after check list had been made, consult your nearest service dealer. Never attempt to disassemble your unit by yourself.

 **Due to continuous product improvement, the operations are subject to run the model.**

Free Manuals Download Website

<http://myh66.com>

<http://usermanuals.us>

<http://www.somanuals.com>

<http://www.4manuals.cc>

<http://www.manual-lib.com>

<http://www.404manual.com>

<http://www.luxmanual.com>

<http://aubethermostatmanual.com>

Golf course search by state

<http://golfingnear.com>

Email search by domain

<http://emailbydomain.com>

Auto manuals search

<http://auto.somanuals.com>

TV manuals search

<http://tv.somanuals.com>