

PYLE®

OWNER'S MANUAL

PLNV35

Global Positioning System

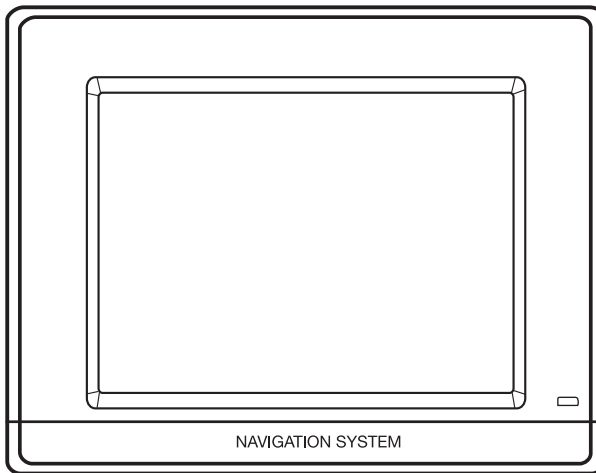

www.pyleaudio.com

Download from Www.Somanuals.com. All Manuals Search And Download.

Contents

- Safety Information**3
- Installation**.....5
- Views**.....8
 - Front View8
 - Back view8
 - Top/Bottom View9
 - Left/Right View.....9
- GPS (Global Positioning System)**10
 - Memory Card Quick Installation10
 - Software Installation on your PC10
 - Contents of the Navigation CDs11
 - Installing Microsoft Active Sync.....11

SAFETY INFORMATION

Safety Instructions

Please read this section carefully and follow all the instructions given.

This will help ensure reliable operation and extend the service life for your appliance.

Keep the packaging and the user instructions for future reference or enquiries at a later date. If you pass the article on to another person, you must pass on these instructions.

- Never open up the housing of the appliance or the power adapter. These contain no user-serviceable parts. If the housing is opened there is a danger to life from electric shock.
- Do not place any objects on the appliance and do not exert any pressure on the display. Otherwise there is a danger that the screen will break.
- To avoid damage, do not touch the screen with sharp objects. Use only the stylus provided.
- There is a risk of injury if the display breaks. If this should occur, use protective gloves to pack the broken parts and contact customer support to arrange for disposal. Then wash your hands with soap, since there is a possibility that chemicals may have escaped.
- Never allow children to play with electrical equipment unsupervised. Children do not always correctly recognize possible danger.
- Remove the power adapter from the outlet, switch the appliance off immediately, or do not actually switch it on, and contact Customer Service ... if the power adapter or the attached plug become scorched or damaged. if the housing of the appliance or the power pack becomes damaged or fluids leak into it. Components must be checked by Customer Service in order to avoid damage!

Data Security

- Every time you update your data make backup copies on an external storage medium. The supplier does not assume liability for data loss or damage to data storage units, and no claims can be accepted for damages resulting from the loss of data or for consequential damages.

Operating Environment

- Keep your navigation system and all connected devices away from moisture and avoid dust, heat and direct sunlight, especially in the car.
- Make sure you protect your appliance from getting wet. (e.g. from rain and hail, at all times.) Please pay attention that moisture can even build up in a protective pouch because of condensation.
- Avoid heavy vibrations and shaking.
- Avoid the device from releasing itself from its holder, for example when braking. In stall the device as vertically as possible.
Failure to follow these instructions may lead to damage to your appliance.

Ambient Temperature

- The appliance is most reliably operated at an ambient temperature of between 41°F to 104°F (5°C to 40°C) and at a relative humidity of between 10% to 90%.
- In the powered down state the appliance can be stored at between 32°F to 140°F (0°C to 60°C).
- Store the appliance in a safe location to avoid high temperatures (e.g. when parking or from direct sunlight).

Electromagnetic Compatibility

- When connecting additional or other components the “Electromagnetic Compatibility Directive”(EMC) must be adhered to. Please also note that only screened cable (maximum 10ft) should be used with this appliance. For optimal performance, maintain a distance of at least 3 metres from sources of high-frequency and magnetic interference (televisions, loudspeaker systems, mobile telephones and so on.) This will help avoid malfunctions and loss of data.

Battery Operation

Your appliance is operated with a removable battery. In order to prolong the life and efficiency of your battery and to ensure safe operation, follow the instructions below:

- **Warning:** Danger of explosion if rechargeable batteries are not charged properly. Only replace with the same type of battery or a similar type recommended by the manufacturer. Never open the rechargeable battery.

SAFETY INFORMATION

Do not throw the rechargeable battery into fire. Dispose of the used batteries following the manufacturer's instructions.

- Batteries cannot withstand heat. Avoid the appliance and the integrated battery becoming overheated. Failure to comply with this instruction may lead to damage to and even explosion of the battery.
- Use only the original power pack to charge the battery or the car adapter from the optional navigation kit.
- The batteries are special category waste. When disposing of the appliance ensure that this is done correctly. Contact Customer Service for more details.

Care of the Display

- Avoid scratching the display surface as this is easily damaged. It is strongly recommended to use a display protection mylar to avoid scratches. Please ask your nearest dealer for this accessories. The foil on the display at delivery is purely for protection during transportation!
- Ensure that no traces of water remain on the screen. Water can cause irreversible discoloration.
- Use only a soft , lint-free cloth to clean the screen.
- Do not expose the screen to either strong sunlight or ultraviolet radiation.

Transport

If you wish to transport the appliance follow the instructions below:

- Following transport of the appliance wait until the unit has acclimatized before using it.
- In the case of wide fluctuations in temperature or humidity condensation or moisture may form inside the appliance and this can cause an electrical short-circuit.
- In order to protect the appliance from dirt, knocks and scratching, use the protective case.
- Before traveling ensure that you are aware of the power and communications provision at your destination. Before traveling obtain any power or communications adapters(modem, LAN, etc.) That may be needed.
- When shipping your appliance use only the original packaging and advise the carrier accordingly.

- When passing through the hand luggage control at airports, it is recommended that you pass the appliance and all magnetic storage media (external hard drives) through the X-ray system (the machine on which you place your bags). Avoid the magnetic detector (the structure through which you pass) or the magnetic wand (the hand device that the security staff use), since this may corrupt your data.

Connection

When connection your appliance be sure to correctly observe the following instructions:

- The outlet must be in the vicinity of the appliance and must be easily accessible.
- Only use the mains adapter on grounded sockets at 100-240V~AC, 50/60Hz. If you are unsure about the power supply to the place of use, ask the relevant energy supplier.
- Use only the power adapter provided with your appliance.
- For additional safety, we recommend the use of a surge protector in order to protect your appliance from damage by electricity spikes or lightning strikes on the power network.

Power Through Car Adapter

- The car adapter should only be connected to the lighter socket of a car (car battery =DV12V ,no trucks!). If you are in any doubt about the power source in your car, contact your car manufacturer.

Cabling

- Arrange cables so that no-one can tread on them or trip over them.
- Do not place any items on the cable.

WARNING

When the unit is not in use for a long time, please switch the Power On/Off switch to unlock position and recharge the battery every other time, otherwise the battery's lifetime would be shortened.

INSTALLATION

The following guides you step by step through the initial set up of the navigation system.

Firstly, remove the foil for protecting the device during transportation from the display.

How to access to the navigation system

Press **Sleep/Wake** up button on the unit for about two seconds to wake up the unit (Note: Sometimes the unit will not be woken up by reason of low battery, please charge the battery. When charging the indicator light is red). The brand logo will appear and your device will display the application screen after a few seconds.

Attention: According to the charging status of the accumulator installed. It is necessary for the device to be charged before the initial setting up can run through.

Charging Battery of the Navigation system

You have different options to charge the battery of your navigation system:

- With the help of the network adapter.
- By means of the car adapter.
- Do not interrupt the charging process before the battery is fully charged. It will take a few hours for the navigation system is fully charged.
- **Note:** You can use the navigation system during the charging process, but the power supply must not be interrupted during initial set-up.
- Leave the mains adapter connected to the navigation system for around 24 hours, so that the backup battery can be fully charged.
- You can leave the main adapter connected, and this is very handy for continuous operation. However, the mains adapter also requires power even when it is not charging up the battery of the navigation system.

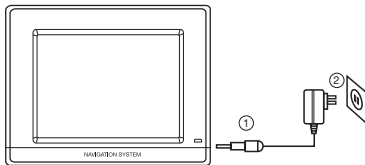

Push the adapter connector into the guide on the right of the network adapter. Push the Network Adapter (2) into a power point that is easily accessible.

Push the cable of the Network Adapter (1) into the network adapter connection of the navigation system.

Working with memory cards

Your navigation system supports MMC and SD memory cards.

Inserting memory cards

1. Carefully take the memory card out of its packing (if included). Take care not to touch or dirty the contacts.
2. Push the memory card carefully into the card bay. The side of the memory card wearing the label must point upwards. The memory card should slightly lock in place.

Removing memory cards

- Do not remove the memory card while it is accessed. This could result in loss of data.
1. To remove the card press lightly onto the upper edge until it ejects.
 2. Pull the card out without touching the contacts.
 3. Store the memory card in the packing or in another safe location.
- Memory cards are very fragile. Take care not to dirty the contacts and not to force the card.

Accessing Memory Cards

- The appliance only supports memory cards in the FAT16/32 file format. If you insert a card prepared with a different format (e.g. in cameras, MP3 players), your navigation system may not recognize it and will ask you to format it again.
- **Warning:** Formatting the memory card irretrievably wipes out all data.
- Likewise you cannot just copy files onto the memory card. In some cases they must be converted by the Microsoft ActiveSync program.

Data Exchange VIA Card Reader

You can transfer or synchronise data via ActiveSync. This is also the correct method, in particular, if files are to be transferred that must be converted into a navigation system-readable format.

However, if you wish to copy large quantities of data (navigation maps) to the memory card, these can also be stored directly to the memory card.

Many computers already have memory card devices. Insert the card in this and copy the data directly to the card.

Because of the direct access significantly faster transfer will be achieved.

INSTALLATION

Resetting The Navigation System

There are two options for resetting the navigation system.

Soft Reset

This option restarts the navigation system, without reinstallation being necessary. A soft-reset is often used in order to reorganize the memory. In doing so all programs that are running are interrupted and the working memory is reinitialized. Choose this option if your navigation system is not responding or working properly.

Perform the soft-reset as follows: Screw off the end cap of the pointer and carefully press the point of the end cap into the reset opening on the left side of your device.

Safety Instructions for Navigation

The bundled product CD contains a comprehensive instruction manual.

Tips for Navigation

- Do not manipulate the navigation system while driving to protect yourself and others from accidents!
- In the event that you do not understand the voice instruction or if you are in any doubt about what to do at the next intersection, then the map or arrow display will provide you with a quick orientation. Only look at the display when you are in a safe driving situation!
- **Attention:** The road layout and driving rules take precedence over the instructions of the navigation system. Only follow the instructions when circumstances and driving rules permit it! The navigation system will guide you to your destination even when you have to deviate from your planned route.
- The direction statements of the navigation system given do not release the driver of the vehicle from his or her duty of care or personal responsibility.
- Plan routes before you leave. If you want to plan a new route whilst on the road stop driving.
- In order to receive the GPS signal correctly, metal objects may hinder reception. Attach the navigation system onto the inside of the windscreen or near the windscreen with the sucker. Try out different positions in your vehicle in order to find the best reception.

Notes for Use In A Vehicle

- Take care that the holder does not present any risk to safety, even in the case of an accident, when installing it.
- Take care that the cable does not impede any safety components.
- The display of your navigation system may show "light" will reflect light. Please take care of not being "blinded" during operation.
- Take care that the cable does not impede any safety components.
- Do not mount the components within the operating range of any airbags.
- Check the secure adherence of the suction cup at regular intervals.
- The power plug will consume power, even if no device is connected. Remove it when not in use to avoid draining the battery.
- Check all safety equipment in your car after installation.

Additional Notes for Use on A Bicycle Or A Motorcycle

- Pay attention during installation that the ability to steer is not impaired.
- Do not cover any instruments during installation.

Mounting The Navigation Set In A Car

Attention! Only fix the holder for the navigation system to the windscreen, if it does not impede the view. Should this not be possible, Then mount the holder with the enclosed suction plate in any way that will allow peril-free and safe operation.

Installation Of The Holder Of The Navigation System

- **Hint:** If you want to fix the holder to the wind screen, then you can skip steps 1 and 2.
1. Remove the protective foil from the sticky side of the suction plate.
 2. Fix the suction plate to a suitable location on the dashboard. Take care, that the surface of the dashboard is clean and press the suction plate strongly onto the surface.
- To obtain a strong and secure hold the suction plate should not be used for 24 hours.

INSTALLATION

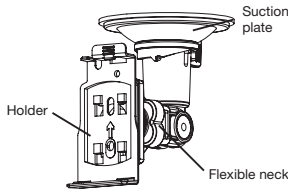

3. Mount the car holder to the flexible neck. Note the labels on the flexible neck. The arrow labeled **CLOSE** must point in the direction of the fixture. The connection closes with a noticeable clicking sound.
4. Place the holder with the suction head onto the suction plate (or directly onto the wind screen) and press the lever on the suction head downwards. The suction head will stick itself firmly to the suction plate.
5. Place the navigation system into the car holder by placing it initially in the lower noses and then pressing it down gently until the holder clicks in.

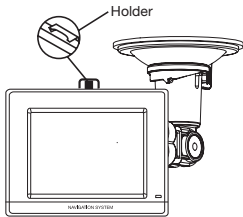

Connecting The Navigation System In The Car

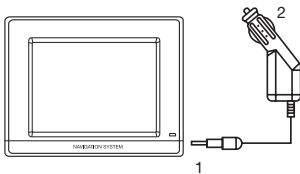

- When the battery is in a low voltage, you can recharge it in the car:
1. Plug the jack (1) of the connection cable into the corresponding receptor at the bottom of your navigation system.
 2. Insert the power adapter (2) now into the cigarette lighter socket and ensure, that it will not lose contact while driving. This could cause a malfunction.
- **Hint:** Remove the power adapter from the cigarette lighter socket when ending a trip or when parking the car for a extended period of time.

Mounting The Navigation Set On A Bicycle

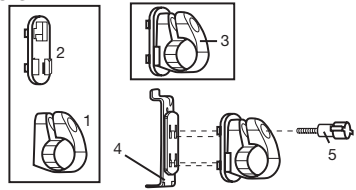

1. Place the clip (1) and the Retaining Plate (2) together and fix them to your bicycle handlebars by pulling them across the handlebars from below and pushing one of the rubber rings (3) supplied between the clip and the handlebars. The flat site of the support points in your direction. As the material is elastic, you can care fully bend open the support, lay it around the handlebar and push it together again.
2. Place the holder for the navigation system (4) on the Retaining Plate (2) as illustrated above. Push the holder for the navigation system downwards until it clicks in audibly. Please pay attention that the holder must only be used in one direction.
3. Fix the complete holding device with the supplied screw (5) and tighten it slightly by hand.
4. Now insert the navigation system into the holder. You must pay attention to a firm seating of the clip holder.
5. Set the inclination angle by screwing the bicycle holder in according to your requirements. Now turn the screws finger-tight.

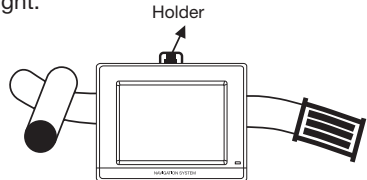

Note: After assembly, protect your navigation system from dust and dirt using the storage pocket. The storage pocket does not protect against rain or moisture. Take care that the navigation system does not exposed to moisture. This may damage the electronic parts. When you use the navigation system, make the navigation system upright with the GPS antenna (13) will get a strong signal. If the signal is not good, please adjust the direction of the GPS antenna to receive the signal.

VIEWS

Front View

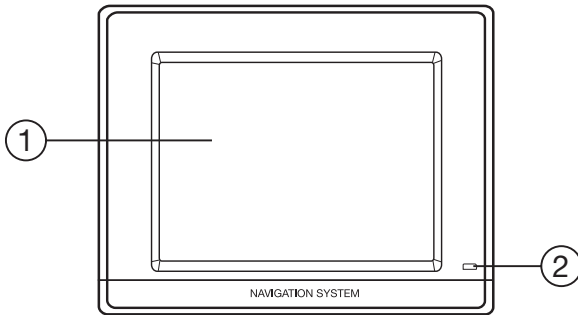

1. Touch Screen

Display the output of your appliance. Tap the screen with the stylus to select menu commands or input information.

2. Battery Charge Indicator

When the battery is charging the Indicator is red, When the battery is fully charged, the Indicator will turn to green.

Back View

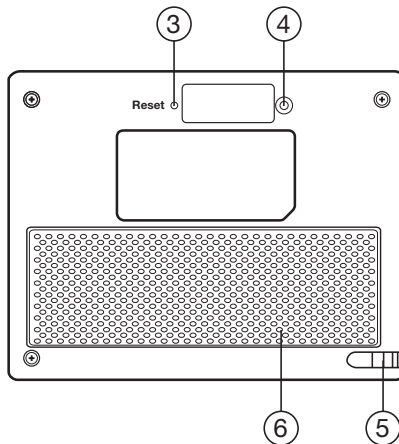

3. Reset button

Press it to reset the unit.

4. External aerial interface

Playback language statements and warnings.

5. Stylus

Take the pen out of its compartment in order to use it, and replace it after use. The pointer pen is required for operating the touch screen.

6. Loudspeaker

Playback language statements and warnings.

VIEWS

Top / Bottom View

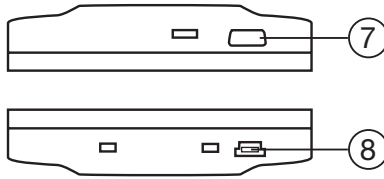

7. Sleep/Wake up Button

Press and hold Sleep/Wake up button for about two seconds to Wake up the unit.

8. USB Interface

Interface for connecting to a PC by means of the ActiveSync Cable (for data matching).

Left / Right View

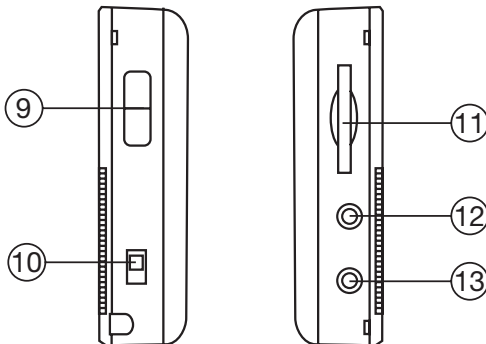

9. Volume+/-

10. Battery On/Off

11. SD/MMC Slot

12. Headphone Interface

13. AC Adaptor Port

Use it to change the volume level up or down.

Switch to turn the power On/Off.

Accepts an optional SD (Secure Digital) or MMC (Multi MediaCard) Card for removable storage.

Connects to a pair of stereo headphones.

Connection to external power supply.

GPS(Global Positioning System)

GPS is a satellite-backed system for determining your position. With the help of 24 satellites revolving around the earth, it is possible to determine your position on earth with the accuracy of a few meters. The satellite signals are received by the antenna of the built-in GPS receiver, which must have a "line of sight" to at least 4 of these.

Note:

- By limited line of sight (e.g. in tunnels, between houses, in woods or also in vehicles with metal-coated windows) it is not possible to determine the position. The satellite reception however automatically picks up again as soon as the obstacle has been passed and the line of sight is reestablished again.
- Please note that your appliance is preset to not shut down automatically after a few minutes without activity. You can Change this preset in the Settings mode.
- If the GPS receiver has not been active for some hours, it must orientate itself again. This process may take a while.

Memory Card Quick Installation

This option is only available to you if your navigation system is equipped with a prepared memory card. In this case, you will ready be able to use the Navigation function of your device after a short time, without carrying out the pre-installation on a PC.

- The initial setting up must be carried out as described on page 15 in any case.
- The following installation limits the Navigation to the area which is pre-installed on your memory card.

You must carry out these steps to put the navigation into operation in your car:

1. Read and adhere to the safety instructions on p.2 and following and p.23 and following.
 2. Install the remaining components of the navigation system.
 3. Press the **Sleep/Wake up** button to start your navigation system. If the instructions of **Step1** have not yet been executed, then do it now. The battery should be charged. The accumulator will be charged by means of the car power supply if necessary.
- Insert the pre-installed memory card in the navigation system. The installation of the navigation software will start

automatically. Follow the instructions on the screen.

NOTES:

- The memory card must always be inserted into the device during the use of the navigation system.
- A Soft Reset will have to be carried out to restart the navigation system, if the memory card is removed during its use, even for a short time.

Set the date and time by means of the Settings button and the date/time control button, if this has not yet taken place. Set the applicable time zone, if available.

Starting Navigation

1. Press the **Sleep/Wake up** button for about two seconds to wake up your navigation system.
2. The navigation software will start automatically or after clicking on the navigation control button, according to the version.
3. Press the menu icon to enter the destination and the address of your navigation destination. Then start the navigation by clicking on Navigate. YOU will receive the route information on the screen, augmented by language statements, after a short time, if the satellite reception is adequate.

Please take information about the further operation of the Navigation software from the comprehensive User Handbook on the Navigation CD. In addition, brief help is available to you on your navigation system. You will reach it by means of the Options/Destination Entry icon and by selecting the help function.

Note: The GPS-receiver will require some minutes for initialization when deployed for the first time. Even when GPS signal reception is indicated the navigation could be imprecise. In all future instances it will take about 30-150 seconds until a correct GPS-signal is available, sufficient "sight" of the satellite is a prerequisite.

Software Installation On Your PC

In order to be able to deploy self-defined cards on your navigation system you must install the corresponding navigation software on your PC.

1. Before installing the navigation software ensure that ActiveSync is installed and your navigation system is connected

GPS(Global Positioning System)

- with your PC via the ActiveSync-cable.
2. Place the CD 1 with the navigation software in your CD drive. The installation will start automatically.
 3. Follow the program instructions.

Contents of The Navigation CDs

It is possible for several CDs to be contained in the scope of the delivery according to the version. Content of the CDs:

CD 1 contains the PC application, digitalized card material and the data material for restoring the content of the memory card fast. Additional material on the card will be located on the optional CD2. The PC application will be installed on the computer and used to set up your own card details. Apart from this, it will support the recreation of data on the memory card.

Installing Microsoft ActiveSync

In order to transfer your data between your PC and your navigation system you need the Microsoft ActiveSync program. The cost of the navigation system includes a license for this program which can be found on the Support CD.

Attention: Important files can be overwritten or changed during the installation of software. You should create a hard disk backup, in order to be able to have access to the original files in the case of possible problems following the installation. You must have administrator rights to install the software under Windows 2000/XP.

Attention: You should not connect the navigation system to your computer yet.

1. Insert the Support CD and wait until the program starts automatically.

Note: The Auto Run function is probably deactivated if it does not function. The Setup program on the CD must be started, to start installation manually.

2. Choose the language, click then Install ActiveSync and follows the instructions on the screen.
3. Connect the navigation system to your computer with the assistance of the ActiveSync Cable, while the connection options are checked. To do this, push the USB connector into a free USB port on your computer. The hardware installation assistant recognizes now a new appliance and installs a suitable

- driver which can take some minutes. Repeat the connection search if it fails the first time.
4. Follow the instructions on the screen. The program will now set up a partnership between your PC and the device.

Free Manuals Download Website

<http://myh66.com>

<http://usermanuals.us>

<http://www.somanuals.com>

<http://www.4manuals.cc>

<http://www.manual-lib.com>

<http://www.404manual.com>

<http://www.luxmanual.com>

<http://aubethermostatmanual.com>

Golf course search by state

<http://golfingnear.com>

Email search by domain

<http://emailbydomain.com>

Auto manuals search

<http://auto.somanuals.com>

TV manuals search

<http://tv.somanuals.com>