

PHRM30

Heart Rate Monitor Watch

PYLE[®] SPORTS

www.pyleaudio.com

KEYS AND THEIR FUNCTIONS

SET/SAVE/EL

MODE



STOP/NEXT

START/LAP



HEART RATE BELT

Operated by 4 keys.

SET/SAVE/EL
STOP/NEXT
MODE
START/LAP

Thank you for choosing the Pulse Sonic – Heart Rate monitor Watch as your personal trainer. In order to be able to make the best use of this device, please read the instruction manual carefully. Do not discard keep the manual for future reference Wear the Heart Rate Belt on your chest with the sensor over your heart for detection of the heart rate.

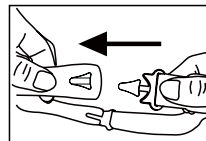

You will notice that there are two noticeably different patches on the inside of the Heart Rate Belt. These are the sensors for detecting your Heart Rate. Before you put the Heart Rate Belt, wet these two patches lightly so that the sensors can detect your heart rate more easily, faster and more accurately.

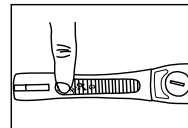

Important : Please note that the Heart Rate Monitor is NOT a medical device and is not to be used as such.

FEATURES

- Time Function
- Chronograph & Timer Function
- Data Function
- Daily Alarm Function
- User Setting and Zone Setting.
- Auto Return Function
- Energy Saving Function

MODE FLOW CHART

Press the MODE key to change between the following modes.

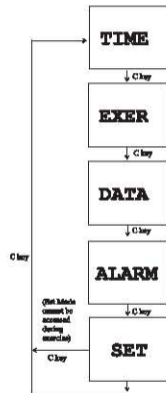

A -START/LAP
B -STOP/NEXT
C - MODE
D -SRT/SAVE/EL

A. TIME MODE

-Date-Time display: Day of week, Day, Hour, Minute, Second.

"TUE 08
12:00 56

(No Heart rate pulse is detected)

"TUE 08
12:00 56
♥ 108 BPM

(Heart rate pulse is detected)

← shows the instantaneous heart rate.

- Press **STOP/NEXT** to start heart rate measurement.
- Press and hold **SET/SAVE/EL** until the hour digits flash to enter the Time Setting mode.
- Press **START/LAP** to increment the setting item.
- Press **STOP/NEXT** to decrement the setting item.
- Press **MODE** to select the setting item in the following sequence:

Hour → Minute → Second → Month → Day → Year → 12/24 Hr



- Press **SET/SAVE/EL** to exit the Real Time setting.

B. EXERCISE MODE

1. Initial Display:

Count Up Timer (Chronograph)



Count Down Timer



- Press **START/LAP** key to start counting. If the Chronograph is selected and is running, press **START/LAP** key to take lap.
- Press **STOP/NEXT** key to stop counting. Press and hold **STOP/NEXT** key will enable/disable the zone alarm beep and icon.
- Press **MODE** key any time can exit the Exercise mode to the Data Mode.
- Press and hold **SET/SAVE/EL** key to Save or Clear the displayed EXERCISE if it is in stop state.
- If the Exercise mode is in reset state, press and hold **SET/SAVE/EL** key to enter exercise setting mode.

Different type of exercise can be selected:

AEROBIC, EX BIKE, STEPPER, TREADML, JOG, WALK, BIKE, OTHER

- Press and hold **SET/SAVE/EL** for 2 second change the exercise type by pressing **START/LAP** or **STOP/NEXT** Press **MODE** accordingly to confirm exercise type, count up and count down timer and high / low zone Press **SET/SAVE/EL** to confirm the data and finally press **START/LAP** to start the exercise

-Target zone selection.

-Press **START/LAP** or **STOP/NEXT** to select zone

-Press **MODE** to choose Count Up / Count Down timer to record exercise.

-Count Up (Chronograph) or Count Down timer can be selected.Count Down Timer time can be set up to 24 hours (if the time is set to 0:00'00).

Count Up (Chronograph) counts up to 24:00'00 and stops automatical

2.Chronograph/Count Down Timer

-Record exercise time in Hour, Minute, Second, average / maximum / minimum / ending heart rate, Below/In/Above zonetime and percentage, calorie and fat consumption.

Chronograph is running



Count Down Timer is running



-Selected Target zone icon: User can select among 3 target zones to check the instantaneous heart rate is in the target zone or not.

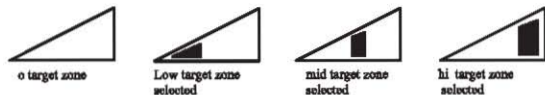

If low / mid / hi target zone is selected and zone alarm is enabled, zone alarm beep will be given if instantaneous heart rate is out of target zone.

-In zone icon: Only displayed if low / mid/ hi target zone is selected. It shows the instantaneous heart rate is in the target zone or not.

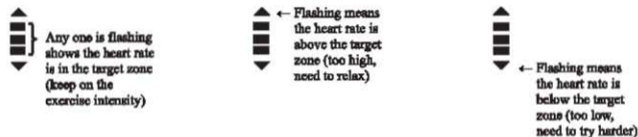

-The Below/In/Above zonetime and percentage will be recorded to reflect the efficiency of training.

-In case no heart rate pulse is detected (for a time out of about 10 seconds after the last heart pulse), the heart rate reading will show "--".

-In case no heart rate pulse is detected (for a time out of about 60 seconds after the last heart pulse), the heart rate reading will be blank. No in zone icon will be shown. User needs to press SET/SAVE/EL key to turn on the receiver to start heart rate measurement again.

-During the exercise running, heart rate is kept on measuring. If heart rate is out of the target zone, zone alarm beep will be given out.





Zone alarm beep:

Above zone alarm: beep .. beep .. beep (every 4 seconds)

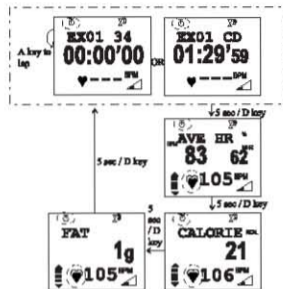
Below zone alarm: beep — (every 4 seconds).

-During the exercise running, the display will cycle exercise time, average heart rate, caloric and fat consumption. Average heart rate will only be shown if heart rate pulse is measured. Caloric and fat consumption will only be shown if caloric measurement is selected to be on.



-The In Zone icon  will flash the corresponding point to indicate the heart rate is in or out zone. If either the  or  is flashing, user should adjust his exercise intensity to let the heart rate fall back to the  range.

-Taking Laps:

-If Chronograph is running, press START/LAP key to take lap. The display will freeze to show the split time for 5 seconds.

-Manual Stop:

-Press STOP/NEXT Key when the exercise is running to stop. Press START/LAP key in stop state can start again. Even the exercise has stopped, the display will cycle the exercise time, average heart rate, caloric and fat consumption in sequence.

-Enable/Disable of Zone alarm:

-Press and hold STOP/NEXT key will toggle the zone alarm beep and icon.

-Store Up / Reset a Exercise:

-Press and hold SET/SAVE/EL key until beep when the exercise is in stop state to close the current EXERCISE and start a new exercise. User can select to save or clear (not save).

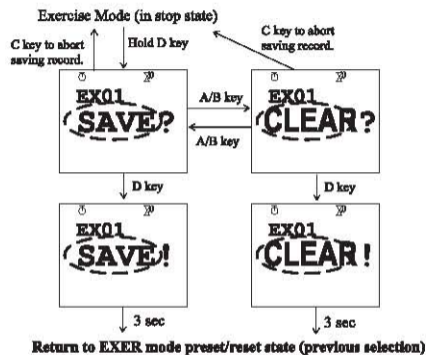

-Counting finish:

-If Count Down timer time counts to 0:00'00, 5 seconds beep will sound. The timer cannot start again. Press START/LAP key will display "FINISH!".

-If Count Up (Chronograph) counts to 24:00'00, it will stop automatically and cannot start again. Press START/LAP key will display "FINISH!".

-Data Memory full:

Maximum 40 Exercise data records can be stored. Press and hold the SET/SAVE/EL key if the 41st records is stop, only "CLEAR?" can be selected.

C. DATA MODE

Reviews the records taken in Exercise mode. Max. 40 exercise records can be stored.

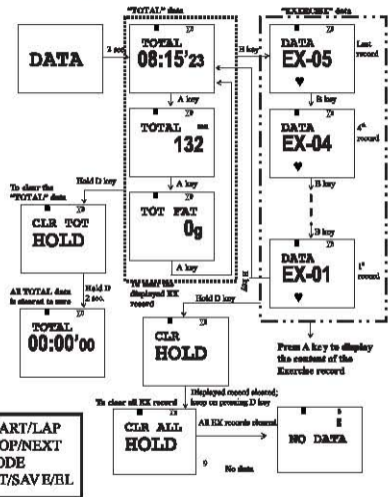

For Total Data

- Go to **MODE** and choose Data as to show the total data.
- Press **START/LAP** to show the data total calorie and total fat.
- Hold **SET/SAVE/EL** to clear the total data for 2 second data is cleared to zero.

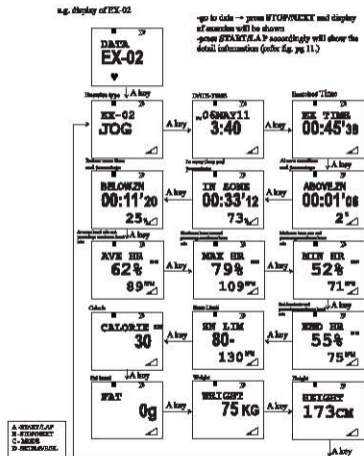

- Skip Above Zone / In Zone / Below Zone / Zone Limit display if "no zone" is selected.
- Press and hold **SET/SAVE/EL** key to erase the displaying exercise (only under EX-## is displaying). Only a closed exercise can be erased. Keep on pressing **SET/SAVE/EL** key to erase all the data records.
- Press and hold **SET/SAVE/EL** key when displaying total time or calorie/fat to erase the total.
- Press **MODE** key to exit DATA mode to enter Daily Alarm mode.

D. DAILY ALARM MODE

- Press **START/LAP** key to enable/disable the daily alarm.
- Press **STOP/NEXT** key to select chime and key tone function.
- Alarm beeps output for 30s or stopped by any key pressing when alarm time reached.
- Hourly chime will be given if chime is enabled.
- Display:



-Setting Daily Alarm time:

Press and hold **SET/SAVE/EL** key D to enter Daily Alarm Setting. Press **START/LAP** key to increment to item. Press **STOP/NEXT** key to decrement the item. Press **MODE** key to select different setting item in the following sequence:

Hour → Minute

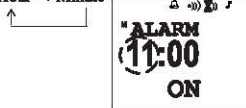

Press **SET/SAVE/EL** key to confirm the setting.

E. USER SETTING MODE

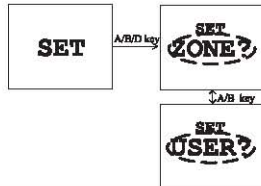

1. Zone Setting

- Zone 1 (low) default: 50~60% of MHR.
- Zone 2 (mid) default: 60~70% of MHR.
- Zone 3 (high) default: 70~85% of MHR.

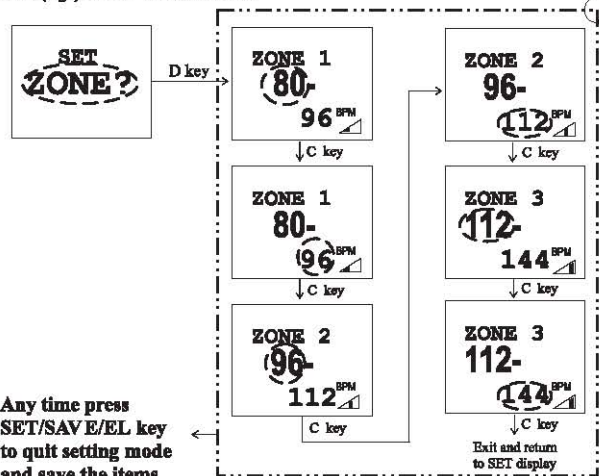

Any time press **SET/SAVE/EL** key to quit setting mode and save the items

Press **A/B** Key to increment/decrement of the zone digit

2. User Setting (Personal Data)

- Body weight unit selection (KG/LB selectable).
- Body weight setting (20-200KG, 40-400LB).
- Body height unit selection (cm/ft-in selectable).
- Body height setting (100-250cm, 3ft 0in ~ 8ft 0in).
- BMI, Body mass index for display only.
- VO2max setting (10-95).
- MHR (default) : 220 - age = MHR
- Age setting (5-99).
- Male/Female selection.
- Calorie / Fat burnt calculation on/off selectable.

- A -START /LAP
- B -STOP/NEXT
- C -MODE
- D -SET/SAVE/EL

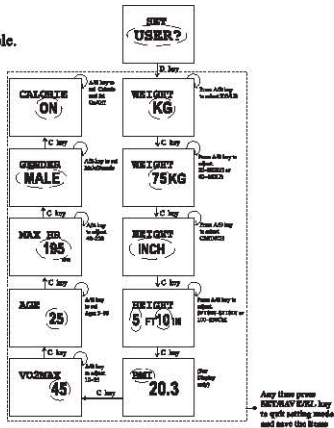

F. AUTO RETURN FUNCTION

In any setting mode, if no keys are pressed in 3 to 4 minutes, it will return to the previous mode before setting.

G. ENERGY SAVE FUNCTION - DISPLAY OFF

If the chronograph / timer is in stop state, in any non-setting mode, press and hold Key MODE key for 3 seconds will enter Display Off mode. Press MODE key to turn on display and enter Time mode.

H. ENERGY SAVE FUNCTION - AUTO DISPLAY OFF

If the chronograph / timer is in stop state, in any non setting mode, the time reaches 12:00am will enter Display Off mode. Press MODE key to turn on display and enter Time mode.

I. RESET THE WATCH

Press and hold 4 keys simultaneously for about 6 seconds will reset the unit.

J. SPECIFICATION

- Operation Mode : Time Mode, Exercise Mode, Data Mode, Communication Mode, Daily Alarm Mode, User Setting Mode
- Real Time Clock : Da of week Da, Hour, Minute & Second display
- Chronograph : Max 24:00:00
- Countdown Timer : To 23:59:59
- Weight : 40lb - 400lb
20kg - 200kg
- Height : 100cm - 250 cm
3 ft 0 in - 8 ft 0 in
- VO2MAX : 10 - 95
- Age : 5 - 99
- Sex : Male / Female
- Pulse Range : 40 - 220 BPM
- Zone Range : 30 - 220 BPM

K. INSTALLING THE BATTERY

The Heart Rate Monitor uses 2 x lithium batteries. Use only the recommended batteries.

Heart Rate Watch

1. The battery compartments located at the back of the watch.
2. To install/replace the battery, unscrew the battery compartment with the screw driver and simply slide out afterwards.
3. Take out the old battery and dispose of properly.
4. Gently place a new battery into the battery slot of the battery compartment, making sure that the poles are correctly placed.
5. Screw back the battery compartment, when finished as in the diagram below

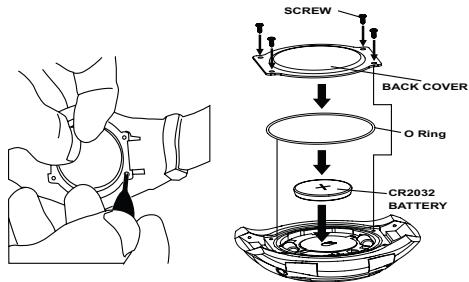

Heart Rate Belt

1. Hold the Heart Rate Belt firmly. Insert a coin into the slit of the compartment lid and turn it clockwise. The lid should come off easily. (Remove used battery CR2032)(Diagram 2)
2. Gently place the battery into the battery slot of the battery compartment.(Diagram 3)
3. Put the compartment lid back into place and tighten it firmly by turning it anti-clockwise with the help of coin.

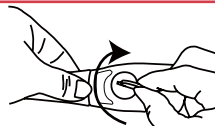

Diagram 2

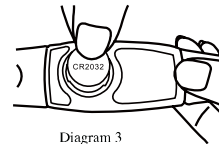

Diagram 3

IMPORTANT BATTERY INFORMATION

- Battery installation and removal should be performed by an adult
- Use only batteries recommended in this instruction sheet
- Be sure to install the batteries with the correct polarity, as indicated
- Remove all batteries when replacing
- Only batteries of the same and equivalent type as recommended are to be used
- Do not short-circuit the supply terminals
- Exhausted batteries should be removed from the product
- Non-rechargeable batteries are not to be recharged
- Rechargeable batteries are to be removed from the product before being charged
- Rechargeable batteries are only to be charged under adult supervision
- Different types of batteries or new and used batteries are not to be mixed.

Noted:

It allows few seconds for changing battery; however data will be lost and need to reset the data.

CAUTION

Should you encounter any problems with the Pulse Sonic (e.g. malfunctioning of a parameter, static electricity, interferences within the product or the need to re-set the device), please reset the watch. All data previously input into the device would be deleted and you can then/will need to re-set the Pulse Sonic all over again. If the Pulse sonic should on the rare occasion fail to function, press and hold the "Set" button in order to clear all data, after which you can input all necessary data again. Should this fail to correct the situation, remove the batteries and then put them back into the battery compartment. Turn on the device by pressing the "Mode" button, and then follow all the steps mentioned above in order to input the necessary data once more. The content of this manual is subject to change without further notice. Due to printing limitation, the displays shown in this manual may differ from the actual display. The manufacturer and its suppliers hold no responsibility to you or any other person for any damage expenses, lost-profits, or any other claim arose by using this product. The contents of this manual may not be reproduced without permission of the manufacturer.

Free Manuals Download Website

<http://myh66.com>

<http://usermanuals.us>

<http://www.somanuals.com>

<http://www.4manuals.cc>

<http://www.manual-lib.com>

<http://www.404manual.com>

<http://www.luxmanual.com>

<http://aubethermostatmanual.com>

Golf course search by state

<http://golfingnear.com>

Email search by domain

<http://emailbydomain.com>

Auto manuals search

<http://auto.somanuals.com>

TV manuals search

<http://tv.somanuals.com>