

User Manual	6
Manuel D'utilisation	56
Manual del usuario	106
Benutzerhandbuch	156
Gebruikershandleiding	206

Thank you for choosing Philips.

Need help fast?

*Read your Quick Start Guide and/or User Manual first for quick tips that make using your Philips product more enjoyable.
To fully benefit from the support that Philips offers, register your product and get support at **www.philips.com/welcome***



PHILIPS

Important notes for users in the U.K.

Mains plug

This apparatus is fitted with an approved 13 Amp plug. To change a fuse in this type of plug proceed as follows:

- 1 Remove fuse cover and fuse.
- 2 Fix new fuse which should be a BS1362 5 Amp, A.S.T.A. or BSI approved type.
- 3 Refit the fuse cover.

If the fitted plug is not suitable for your socket outlets, it should be cut off and an appropriate plug fitted in its place.

If the mains plug contains a fuse, this should have a value of 5 Amp. If a plug without a fuse is used, the fuse at the distribution board should not be greater than 5 Amp.

Note: The severed plug must be disposed of to avoid a possible shock hazard should it be inserted into a 13 Amp socket elsewhere.

How to connect a plug

The wires in the mains lead are coloured with the following code: blue = neutral (N), brown = live (L).

- As these colours may not correspond with the colour markings identifying the terminals in your plug, proceed as follows:
 - Connect the blue wire to the terminal marked N or coloured black.
 - Connect the brown wire to the terminal marked L or coloured red.
 - Do not connect either wire to the earth terminal in the plug, marked E (or e) or coloured green (or green and yellow).

Before replacing the plug cover, make certain that the cord grip is clamped over the sheath of the lead - not simply over the two wires.

Copyright in the U.K.

Recording and playback of material may require consent. See Copyright Act 1956 and The Performer's Protection Acts 1958 to 1972.

Italia

DICHIARAZIONE DI CONFORMITA'

Si dichiara che l'apparecchio HTS8100, Philips risponde alle prescrizioni dell'art. 2 comma 1 del D.M. 28 Agosto 1995 n. 548.

Fatto a Eindhoven

Philips Consumer Electronics
Philips, Glaslaan 2
5616 JB Eindhoven, The Netherlands

Norge

Typeskilt finnes på apparatens underside.

Observer: Nettbryteren er sekundert innkoplet. Den innebygde nettdelen er derfor ikke frakoplet nettet så lenge apparatet er tilsluttet nettkontakten.

For å redusere faren for brann eller elektrisk støt, skal apparatet ikke utsettes for regn eller fuktighet.

ATTENTION!

For Customer Use:

Read carefully the information located at the bottom or rear of your DVD Home Theatre System and enter below the Serial No. Retain this information for future reference.

Model No. HTS8100

Serial No. _____

DK

Advarsel: Usynlig laserstråling ved åbning når sikkerhedsafbrydere er ude af funktion. Undgå udsættelse for stråling.

Bemærk: Netafbryderen er sekundært indkoblet og afbryder ikke strømmen fra nettet. Den indbyggede netdel er derfor tilsluttet til lysnettet så længe netstikket sidder i stikkontakten.

S**Klass I laserapparat**

Varning! Om apparaten används på annat sätt än i denna bruksanvisning specificerats, kan användaren utsättas för osynlig laserstrålning, som överskrider gränsen för laserklass I.

Observera! Stömbrytaren är sekundärt kopplad och bryter inte strömmen från nätet. Den inbyggda nätdelen är därför ansluten till elnätet så länge stickproppen sitter i vägguttaget.

SF**Luokan I laserlaite**

Varoitus! Laitteen käyttäminen muulla kuin tässä käyttöohjeessa mainitulla tavalla saattaa altistaa käyttäjän turvallisuusluokan I ylittävälle näkymättömälle lasersäteilylle.

Oikeus muutoksiin varataan. Laite ei saa olla alttiina tippu-ja roiskevedelle.

Huom. Toiminnanvalitsin on kytketty toisipuolelle, eikä se kytke laitetta irti sähköverkosta. Sisäänrakennettu verkko-osa on kytkettyinä sähköverkkoon aina silloin, kun pistoke on pistorasiassa.

LASER

Type	Semiconductor laser GaAlAs
Wave length	650 - 660 nm (DVD) 784 - 796 nm (CD)
Output Power	7 mW (DVD) 10 mW (VCD/CD)
Beam divergence	60 degrees

CAUTION

VISIBLE AND INVISIBLE LASER RADIATION WHEN OPEN. AVOID EXPOSURE TO BEAM

ADVARSEL

SYNLIG OG USYNLIG LASERSTRÅLING VED ÅBNING UNDGÅ UDSÆTTELSE FOR STRÅLING

VARNING

SYNLIG OCH OSYNLIG LASERSTRÅLNING NÅR DENNA DEL ÄR ÖPPNAD BETRAKTA EJ STRÅLEN

VARO!

AVATTAESSA OLET ALTTIINA NÄKYVÄLLE JA NÄKYMÄTTÖMÄLLE LASER SÄTEILYLLE. ÄLÄ KATSO SÄTEESEEN

VORSICHT

SICHTBARE UND UNSICHTBARE LASERSTRAHLUNG WENN ABDECKUNG GEÖFFNET NICHT DEM STRAHL AUSSETZEN

ATTENTION

RAYONNEMENT LASER VISIBLE ET INVISIBLE EN CAS D'OUVERTURE EXPOSITION DANGEREUSE AU FAISCEAU

This product complies with the radio interference requirements of the European Community.



This product complies with the requirements of the following directives and guidelines: 73/23/EEC + 89/336/EEC + 93/68/EEC

Table of contents

General

General Information	8
Setup precautions.....	8
Accessories supplied	8
Optional GoGear/iPod docking station	8
About recycling.....	8

Product Overview

Main Unit	9
Remote Control.....	10-12
Using the remote control	12

Connections

Basic Connections	13-17
Step 1 : Placement	13
Step 2 : Connecting to TV	14
Option 1: Using the Scart socket	14
Option 2: Connecting to a HDMI-compatible TV	14
Option 3: Connecting to a Progressive Scan TV or component video input.....	15
Step 3 : Connecting the FM and AM/MW antennas.....	16
Step 4 : Connecting the subwoofer to the main unit.....	16
Step 5 : Connecting the power cord	17
Optional Connections	18-19
Connecting to cable box/satellite receiver and recorder/VCR	18
Mounting the main unit	19

Basic Setup

Getting Started	20-25
Finding the correct viewing channel	20
Setting the speakers	20~21
Setting language preferences.....	22
On-screen display (OSD) language	22
Audio, Subtitle and Menu language for DVD playback.....	22-23
Setting the TV Display	23
Setting up Progressive Scan feature	24
Switching to different play source	25
Turning off to low power standby mode.....	25

Disc Playback

Disc Operations	26-33
Playable discs	26
Playing a disc.....	26
Basic playback controls.....	27
Selecting various repeat/shuffle functions.....	27
Programming disc tracks.....	28
Other playback features for video discs (DVD/VCD/SVCD)	28~30
Using the Disc Menu	28
Viewing playback information.....	29
Zooming in/out	29
Changing subtitle language	29
Switching camera angles.....	29
Changing sound track language.....	30
Setting the delay times for audio playback.....	30
Playback Control (VCD only).....	30

Table of contents

Playing a MP3/WMA disc	31
Playing a JPEG image file (slide show)	32
Preview function.....	32
Zoom picture	32
Rotating/flipping the picture	32
Playing MP3/WMA music and JPEG pictures simultaneously	33
Playing a DivX disc	33

Playback other supported devices

Playback - GoGear/iPod.....	34
Playing music from compatible GoGear/iPod devices	34
Playback - USB device.....	35
Playing from USB flash drive or USB memory card reader.....	35
Playback - Other Audio Player	36
Playing from other portable audio player.....	36

Setup Options

Setup Menu Options.....	37-44
Accessing the setup menu.....	37
General Setup Page.....	38
Audio Setup Page.....	39
Video Setup Page.....	40-42
Preference Setup Page	43-44

Radio Tuning

Radio Operations.....	45-46
Tuning to radio stations.....	45
Presetting radio stations	45
Using auto install	45-46
Using automatic preset.....	46
Using manual preset	46
Selecting a preset radio station.....	46
Deleting a preset radio station.....	46

Others

Sound and Volume Controls	47
Volume control	47
Adjusting the Bass/ Treble level	47
Selecting surround sound.....	47
Selecting digital sound effects.....	47
Other Features.....	48
Software upgrades	48
Troubleshooting.....	49-51
Frequently Asked Questions (USB).....	52
Specifications	53
Glossary.....	54-55
Language Code.....	257

General Information

WARNING!

This unit does not contain any user-serviceable parts. Please leave all maintenance work to qualified personnel.

Setup precautions

Finding a suitable location

- Place this unit on a flat, hard and stable surface. Never place the unit on a carpet.
- Never place this unit on top of other equipment that might heat it up (e.g., receiver or amplifier).
- Never put anything under this unit (e.g., CDs, magazines).
- Install this unit near the AC outlet where the AC power plug can be easily reached.

Space for ventilation

- Place this unit in a location with adequate ventilation to prevent internal heat build up. Allow at least 10 cm (4") clearance from the rear and the top of this unit and 5cm (2") from the left and right to prevent overheating.

Avoid high temperature, moisture, water and dust

- This unit must not be exposed to dripping or splashing.
- Never place any object or items that can damage this unit (e.g., liquid filled objects, lighted candles).

Accessories supplied

- 1 subwoofer
- 1 wall mounting bracket and 2 wall mounting knobs
- 1 remote control with batteries
- 1 scart cable
- 1 audio cable (3.5mm to RCA)
- 1 FM wire antenna
- 1 AM/MW loop antenna
- 1 MP3 LINE-IN cable (for connecting portable audio player)
- 1 micro fibre cleaning cloth
- 1 power cable
- Quick Start Guide

Optional GoGear/iPod docking station

This is an optional feature. The docking station available only in selected countries.

About recycling

These operating instructions have been printed on non-polluting paper. The electronic equipment contains a large number of materials that can be recycled. If you are disposing of an old machine, please take it to a recycling centre. Please observe the local regulations regarding disposal of packaging materials, exhausted batteries and old equipment.

Main Unit

English

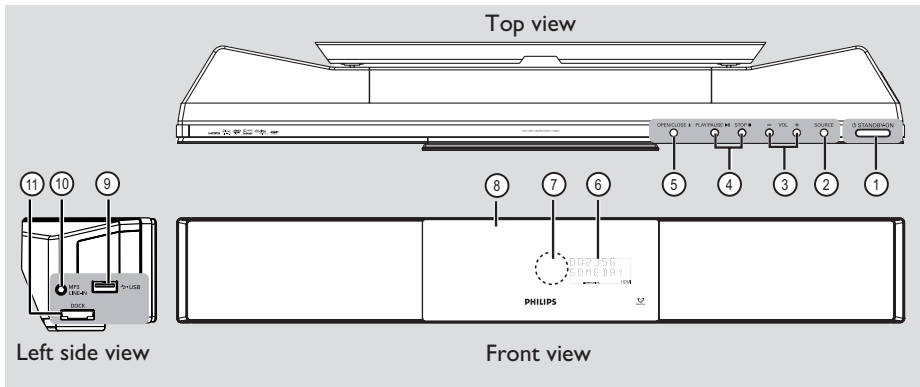

① **STANDBY ON** ⏻

- Turns on this unit or turns off to normal standby mode.
- Press and hold to turn off to low power standby mode.

② **SOURCE**

- Selects the relevant active source mode: DISC, USB, DOCK, MP3 LINE-IN, RADIO FM, RADIO AM/MW, TV1, TV2, AUX1, AUX2 or DIGITAL IN.

③ **VOLUME** + –

- Adjusts the volume level.

④ **PLAY PAUSE** ►||

- DISC: starts/pauses playback.
- RADIO: starts auto radio installation for first time setup.

STOP ■

- Exits an operation.
- DISC: stops playback.
- RADIO: press and hold this button to erase the current preset radio station.

⑤ **OPEN/CLOSE** ▲

- Opens/closes the disc compartment.

⑥ **Display panel**

⑦ **iR sensor**

- Point the remote control towards this sensor.

⑧ **Disc compartment**

⑨ **USB socket**

- Input for USB flash drive or USB memory card reader.

⑩ **MP3 LINE-IN socket**

- Phono input for connecting to the headphone out socket on your portable audio player.

⑪ **DOCK socket**

- Input for GoGear/iPod docking station (optional feature - available in selected countries).

Remote

English

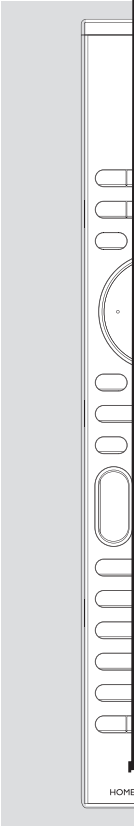

Remote Control (continued)

14 DISC MENU

- For DVD, enters or exits disc contents menu.
- For VCD/SVCD, enters digest menu while in stop mode; turns on/off PBC mode during playback.

15 OK

- Confirms an entry or selection.

16 Cursor keys

- DISC: selects movement direction in the menu.
- RADIO: press up or down to tune the radio frequency.
- RADIO: press left or right to start auto search.

17 TITLE ↵

- For DVD, go back to the previous menu.
- For VCD version 2.0 only; During playback, display the disc title menu or return to the main menu.

18 PREV / REW ◀◀, NEXT / FFW ▶▶

- DISC: skips to the previous or next title/ chapter/track.
- DISC: press and hold this button for fast forward and backward search.
- RADIO: selects a preset radio station.

19 MUTE

- Mutes or restores the volume.

20 VOL + –

- Adjusts the volume level.

21 AMBISOUND

- Switches the surround sound mode between Auto, Multi-Channel and Stereo mode.

22 SELECT/PROGRAM

- DISC: starts programming.
- RADIO: press and hold this button to start automatic/ manual preset programming.
- Make multiple selection in the menu.

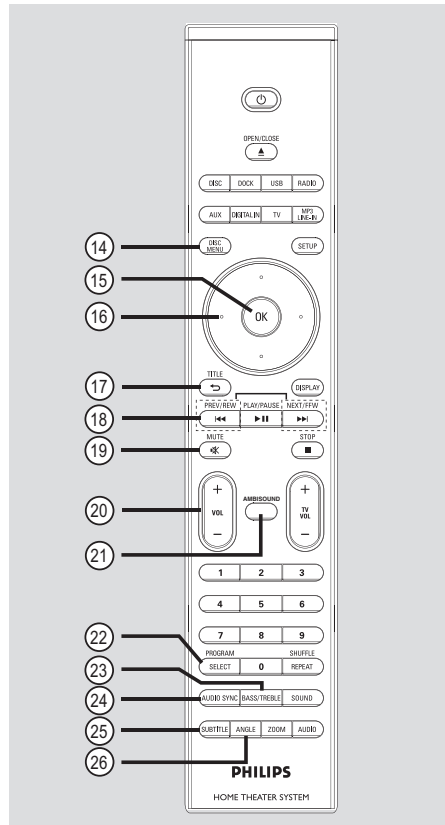

23 TREBLE / BASS

- Toggles between Treble and Bass mode. Immediately after toggling, adjust the volume control to change the level settings

24 AUDIO SYNC

- Sets the audio output delay times if the video playback is slower than the audio output.

25 SUBTITLE

- Selects a DVD subtitle language.

26 ANGLE

- Selects a different viewing angle of a DVD movie (if available).

Remote Control (continued)

Using the remote control

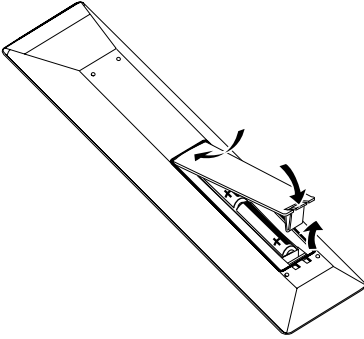

- 1 Open the battery compartment.
- 2 Insert two batteries type R06 or AA, following the indications (+ -) inside the compartment.
- 3 Close the cover.
- 4 Point the remote control directly at the remote sensor (iR) on the front panel.
- 5 Select the source you wish to control by pressing the DISC, DOCK, USB, RADIO, AUX, DIGITAL IN, TV or MP3 LINE-IN button on the remote control.
- 6 Then select the desired function (for example ◀◀, ▶▶).

CAUTION!

- Remove batteries if they are exhausted or if the remote control is not to be used for a long time.
- Never mix batteries (old and new or carbon and alkaline, etc.).
- Batteries contain chemical substances, they should be disposed of properly.

Basic Connections

English

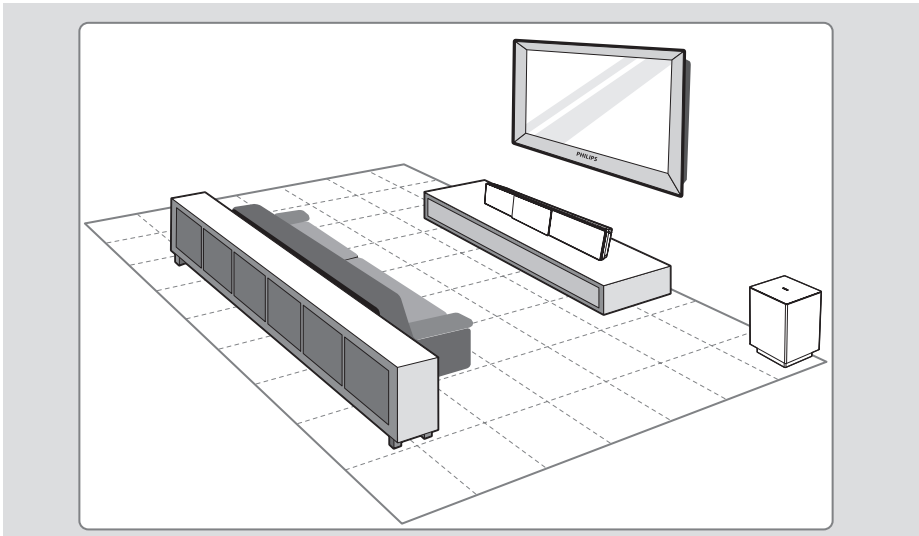

Step 1: Placement

Note:

Never place the main unit in an enclosed cabinet.

Helpful Hints:

- For optimum performance, place the main unit on top of a table or mount it on the wall.
- For Sound Bar speaker setting, see 'Getting Started - Setting the speakers'.

- 1 Place the main unit at a height that is closest to the listening ear-level.
- 2 Position the main unit so that it is directly parallel to the listening area.

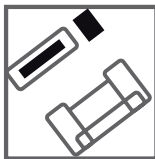
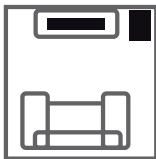

- 3 Place the subwoofer at the corner of the room or at least one metre away from the TV.

Basic Connections (continued)

English

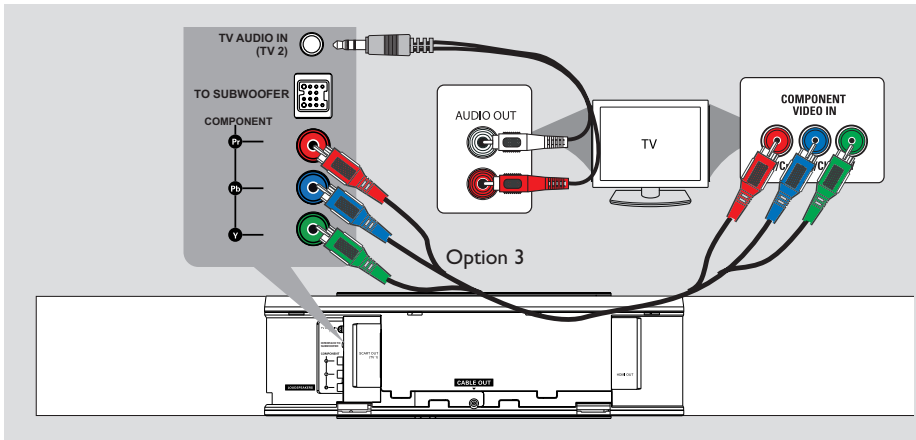

Option 3: Connecting to a Progressive Scan TV or component video input

The progressive scan video quality is only available when using Y Pb Pr connection and a progressive scan TV is required. It provides superior picture quality when watching DVD movies.

- 1 Use the component video cables (red/blue/green - not supplied) to connect the **COMPONENT VIDEO OUT (Y Pb Pr)** sockets on the main unit to the corresponding component video input sockets (or labelled as Y Pb/Cb Pr/Cr or YUV) on the TV.
- 2 If your TV accepts progressive signals, proceed to chapter 'Getting Started - Setting up Progressive Scan feature' for detailed progressive feature setup.
- 3 To hear the TV channels through this unit, use the supplied audio cable to connect the **TV AUDIO IN (TV2)** to the **AUDIO OUT** sockets on the TV.

Helpful Hints:

- Audio connection is not required if the main unit is connected to your TV using the SCART connector.
- To hear the TV programmes through this Home Theatre System, press **TV** button on the remote control to select 'TV2' as the sound source you want to listen to.

Basic Connections (continued)

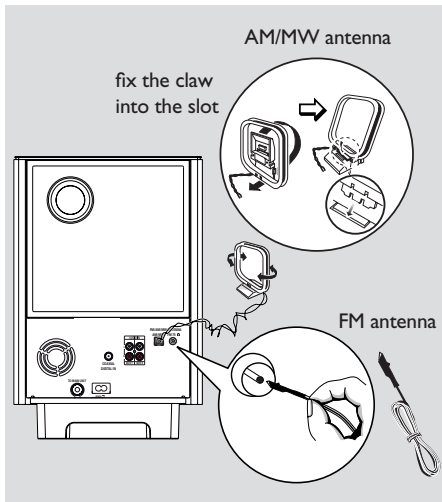

Step 3: Connecting the FM and AM/MW antennas

FM antenna

- 1 Connect the FM antenna (supplied) to the **FM 75 Ω** socket.
- 2 Attach the other end of the FM antenna to a wall.

AM/MW loop antenna

- 1 Stand the AM/MW loop antenna upright to fix its claw into the slot.
- 2 Connect the AM/MW loop antenna to the **AM/MW** socket.
- 3 Place the AM/MW loop antenna on a shelf, or attach it to a stand or wall.

Helpful Hints:

- Adjust the position of the antennas for optimal reception.
- To avoid interference, position the antenna away from the electronic equipment.
- For better FM stereo reception, connect an external FM antenna (not supplied).

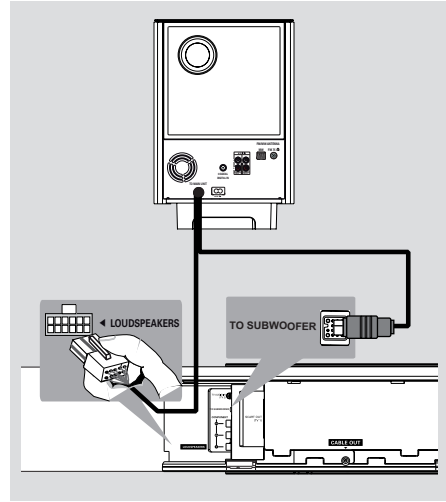

Step 4: Connecting the subwoofer to the main unit

- 1 Unwind the subwoofer's **TO MAIN UNIT** interconnect cable.
- 2 Connect the white end of the interconnect cable to the **LOUDSPEAKERS** socket on the main unit.
- 3 Connect the black end of the interconnect cable to the **TO SUBWOOFER** socket on the main unit.

Basic Connections (continued)

English

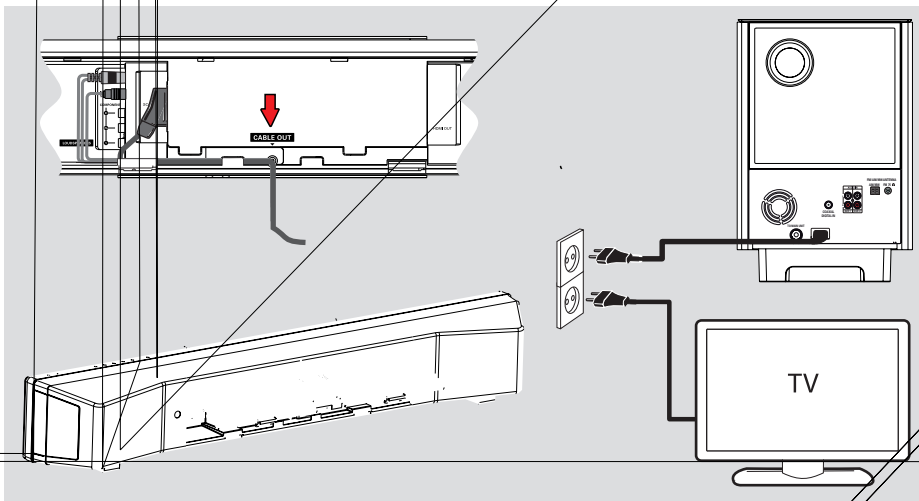

Step 5: Connecting the power cord

Note:

For power supply rating, refer to the rear or bottom of the main unit.

- 1 When all the connections are complete, direct all the cables to the CABLE OUT point.
- 2 Close the rear cover.

Note:

All the cables must be placed properly inside the rear panel in order for the rear cover to close.

- 3 Connect the AC power cord from the subwoofer to the power outlet.
→ The standby LED on the main unit lights up.

Helpful Hint:

– Before making or changing any connections, make sure that all the devices are disconnected from the power outlet.

Optional Connections

English

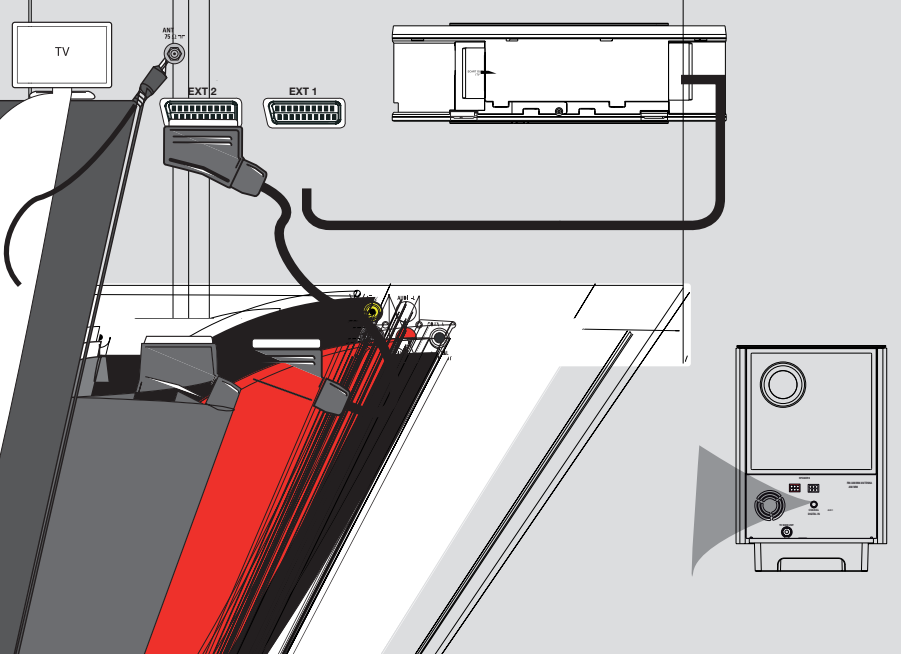

...ogue and digital
...u can connect the
...an audio/video device
...er VCR, Cable/Satellite
...me Theatre System in
...the multi-channel
...and capabilities.

...this illustration is only an example
...possible connections. It may be
...depending on the connected
...devices.

- ▲ Keep the existing connections between your TV and other devices.



Getting Started

Finding the correct viewing channel

Before you start ...

Remove the door stop tag on top of the disc compartment door.

- 1 Press **SOURCE** button on the main unit until 'DISC SOURCE' appears on the display panel (or **DISC** on the remote control).
- 2 Turn on the TV and switch it to the correct video-in channel.
 - You may go to the lowest channel on your TV, then press the Channel Down button on your TV's remote control until you see the Video In channel.
 - You may press  button repeatedly on your TV's remote control.
 - Usually this channel is between the lowest and highest channels and may be called FRONT, A/V IN, VIDEO, etc..
 - Refer to your TV's user manual on how to select the correct input on your TV.

The first screen appears on TV

When you complete the connections and turn on this unit to the 'DISC SOURCE' mode for the first time, you see the welcome message on the TV.

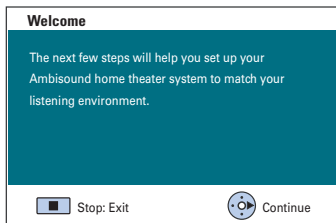

It is advisable that you make several basic settings to optimise the performance of this unit. See the following pages for more information.

Setting the speakers

There are four parameters to adjust the speakers: room acoustics, placement, height and distance. Change the speaker settings according to your room environment and setup.

- 1 Upon seeing the welcome message in 'DISC SOURCE' mode, press cursor right key on the remote control to access the speaker setup screen.
 - A message on the unit positioning appears.

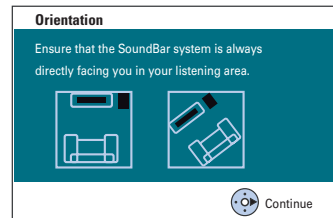

- 2 Press cursor right key to continue.
 - { **Room Acoustics** } menu appears.

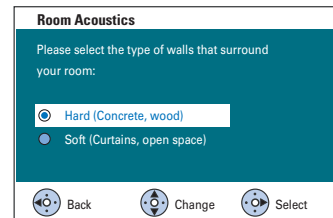

- 3 Select the condition of the room and press cursor right key to confirm.
 - { **Hard** } for concrete or wood surroundings.
 - { **Soft** } for curtains or an open space surroundings.

Getting Started (continued)

Setting language preferences

The language options are different depending on your country or region. It may not correspond to the illustrations shown in the user manual.

On-screen display (OSD) language

The OSD (On-Screen Display) language for this unit remains as you have set it, regardless of the changes made to the DVD disc language.

- 1 In disc mode, press **SETUP** on the remote control.
→ { **General Setup Page** } appears.
- 2 Select { **OSD Language** } in the menu and press cursor right key.

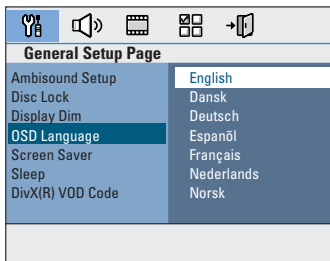

- 3 Select a language and press **OK** to confirm.

Audio, Subtitle and Menu language for DVD playback

You can select your preferred language settings for DVD playback. If the selected language is recorded on the DVD disc, this unit automatically plays the disc in that language. Otherwise, the disc's default language will be used instead.

- 1 Press **■** twice to stop playback (if any), then press **SETUP**.
- 2 Press cursor right key repeatedly to select { **Preference Page** }.
- 3 Select one of the options below and press cursor right key.

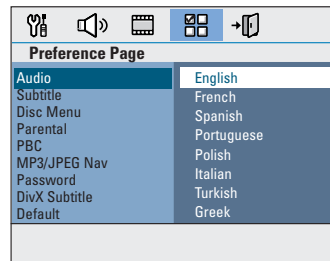

{ Audio }

Select the preferred audio language for DVD playback.

{ Subtitle }

Select the preferred subtitle language for DVD playback.

{ Disc Menu }

Select the preferred disc menu language for DVD playback.

- 4 Select a language and press **OK** to confirm.

Getting Started (continued)

If the language you want is not available in the list, select { **Others** }. Use the numeric keypad **0-9** on the remote control to enter the 4-digit language code 'XXXX' (see last page) and press **OK** to confirm.

- 5 Repeat steps 3 ~ 4 for other settings.

Helpful Hints:

– During DVD playback, you can switch the audio and subtitle languages by pressing the **AUDIO** and **SUBTITLE** buttons on the remote control. However, this does not change the default settings you have made here.

– For some DVDs, the subtitle/audio/menu language can only be changed via the DVD disc menu.

Setting the TV Display

Set the aspect ratio of this unit according to the TV type you have connected. The format you select must be available on the disc. If it is not, the setting for TV display will not affect the picture during playback.

- 1 In disc mode, press **SETUP** on the remote control.
- 2 Press cursor right key repeatedly to select { **Video Setup Page** }.
- 3 Select { **TV Display** } in the menu and press cursor right key.

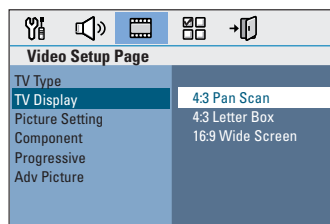

{ **4:3 Pan Scan** }

Select this if you have a conventional TV and want both sides of the picture to be trimmed or formatted to fit your TV.



{ **4:3 Letter Box** }

Select this if you have a conventional TV. In this case, a wide picture with black bands on the upper and lower portions of the TV will be displayed.



{ **16:9 Wide Screen** }

Select this if you have a wide-screen TV.



- 4 Select one of the options and press **OK** to confirm.

Getting Started (continued)

Setting up Progressive Scan feature

(for Progressive Scan TV only)

The progressive scan displays twice the number of frames per second than interlaced scanning (ordinary normal TV system). With nearly double the number of lines, progressive scan offers higher picture resolution and quality.

Before you start...

Ensure that you have connected this unit to a progressive scan TV using the Y Pb Pr connection (see 'Option 3: Connecting to a Progressive Scan TV or component video input').

- 1 Turn on the TV to the correct viewing channel for this unit.
→ Make sure that the TV's progressive scan mode is turned off (or set to interlaced mode). Refer to your TV's user manual.
- 2 Turn on this unit and press **DISC** on the remote control.
- 3 Press **SETUP** on the remote control.
- 4 Press cursor right key repeatedly to select { **Video Setup Page** }.

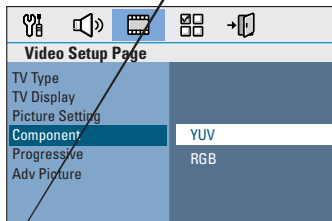

- 5 Move to { **Component** } > { **YUV** } in the menu and press **OK** to confirm.

- 6 Move to { **Progressive** } > { **On** } in the menu and press **OK** to confirm.

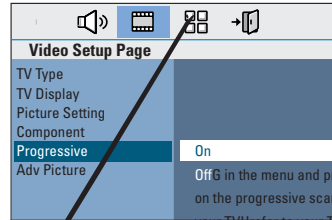

Off in the menu and press **On** at this state until you have turned on the progressive scan mode on your TV. Refer to your TV's user manual in the menu and press **Off**. There are some progressive scan TVs that are not fully compatible with this unit resulting in an unnatural picture when playing back a DVD VIDEO disc in the progressive scan mode. In such a case turn off the progressive scan feature on this unit and your TV.

Getting Started (continued)

different pla

Turning off to low power standby mode

Disc Operations

Playable discs



Your DVD home theatre system plays:

- Digital Versatile Discs (DVDs)
- Video CDs (VCDs)
- Super Video CDs (SVCDs)
- Finalised DVD Recordable (DVD±R), DVD Rewritable (DVD±RW)
- Audio Compact Discs (CDs)
- MP3/ Windows Media™ Audio discs, picture (Kodak, JPEG) files on CD-R(W)
 - ISO 9660
 - JPEG resolution support up to 3072 x 2048
 - Supported sampling frequencies : 32 kHz, 44.1 kHz, 48 kHz
 - Supported Bit-rates : 32~256 (kbps), variable bit rates (average 128 kbps)
- DivX files on CD-R(W)/DVD±R(W):
 - DivX 3/4/5/6, DivX Ultra

Region Codes for DVD discs

DVD discs and players are designed with regional restrictions. Before playing a disc, make sure the disc is for the same region as your player. The regional code for this unit is indicated at the rear or bottom panel.

Note:

- If the inhibit icon (Ø or X) appears on the TV when a button is pressed, it means the function is not available on the current disc or at the current time.
- Never put any objects other than discs on the disc tray. Doing so may cause the disc player to malfunction.

Playing a disc

- 1 Press **SOURCE** repeatedly until 'DISC SOURCE' appears on the display panel (or press **DISC** on the remote control).
- 2 Turn on the TV to the correct viewing channel for this unit.
 - The blue DVD background screen appears on the TV.
- 3 Press **OPEN/CLOSE** ▲ to open the disc compartment.
- 4 Insert a disc into the disc compartment and press **OPEN/CLOSE** ▲.
 - Make sure the disc label is facing towards you. For double-sided discs, load the side which you want to play facing up.
- 5 Playback starts automatically.
 - See the following pages for more playback options and features.

Helpful Hints:

- If you are having trouble playing a certain disc, remove the disc and try a different one. Improperly formatted discs cannot be played on this unit.
- Some discs cannot be played on this player due to the configuration and characteristics of the disc, or due to the condition of recording and authoring software that was used.

Disc Operations (continued)

Basic playback controls

Pausing playback

- During playback, press **▶||**.
 - While in pause mode, you can press cursor left/right keys repeatedly to view the previous or next still picture (for video playback only).
 - To resume playback, press **▶||** again.

Selecting another track/chapter

- Press **◀◀/ ▶▶** or use the **numeric keypad 0-9** to key in a track/chapter number.
 - If the repeat track mode is active, press **◀◀** again to replay the same track/ chapter.

Searching backward/forward

- Press and hold **◀◀/ ▶▶**.
 - While searching, press **◀◀/ ▶▶** repeatedly to decrease/increase the search speed.
 - To resume normal playback, press **▶||**.

Stopping playback

- Press **■**.

Helpful Hints:

- If the message 'To playback from the beginning, press PREV key' appears on the TV while you load in a disc, you can press **◀◀** to playback from the beginning.
- This is a power-saving feature, this unit automatically switches to low power standby mode if you do not press any buttons within 30 minutes after a disc has stopped playing.

Selecting various repeat/ shuffle functions

The available of the repeat play options and shuffle play mode are vary depending on the disc type.

- While playing a disc, press **REPEAT/SHUFFLE** on the remote control repeatedly to choose a repeat/ shuffle play mode.

DVD

- REPEAT CHAPTER
- REPEAT TITLE
- REPEAT DISC
- SHUFFLE
- SHUFFLE REPEAT
- REPEAT OFF (exit repeat mode)

VCD/SVCD/CD

- REPEAT TRACK
- REPEAT DISC
- SHUFFLE
- SHUFFLE REPEAT
- REPEAT OFF (exit repeat mode)

MP3/DivX/Windows Media™ Audio

- REPEAT TRACK
- REPEAT ALL / FOLDER
- SHUFFLE
- REPEAT OFF (exit repeat mode)

Helpful Hint:

- Repeat playback is not possible on VCDs when the PBC mode is turned on.

Disc Operation

Program

(not for Picture Disc)
You can play video discs in the order you specify in the playing order menu.

- 1 Press **SELECT** on the remote control.
→ The program menu appears.

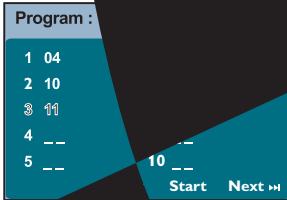

- 2 Use the **number pad 0-9** to enter a number.

the cursor

Other playback features for video discs (DVD/VCD/SVCD)



Disc Operations (continued)

Viewing playback information

This unit can display the disc playback information (for example, title or chapter number, elapsed playing time, audio/subtitle language) and a number of operations can be done without interrupting disc playback.

- 1 During playback, press **DISPLAY**.
→ A list of available disc information appears on the TV.

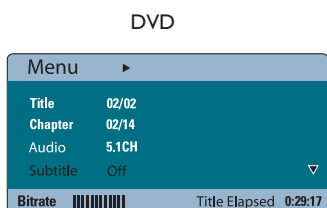

VCD/SVCD



- 2 Use cursor up/down keys to view the information and press **OK** to access.
- 3 Use the **numeric keypad 0-9** to input the number/time or use cursor up/down keys to make the selection.
- 4 Press **OK** to confirm.
→ Playback changes according to the chosen time or to the selected title/chapter/track.

Zooming in/out

This option allows you to zoom in or out the picture on the TV and to pan through the picture.

- 1 During playback, press **ZOOM** repeatedly to select a different zoom factor.
→ Playback continues.
- 2 Use the cursor keys to pan through the zoomed image.
- 3 Press **ZOOM** repeatedly to return to the original size.

Changing subtitle language

This operation works only on DVDs with multiple subtitle languages. You can change the language you want while playing a DVD.

- Press **SUBTITLE** repeatedly to select different subtitle languages.

Switching camera angles

This option is only available on DVDs that contain sequences recorded from different camera angles. This allows you to view the picture from different angles.

- If the camera icon appears on the TV, press **ANGLE** repeatedly to select the available camera angles.

Disc Operations (continued)

Changing sound track language

This operation works only on DVDs with multiple sound track languages, or VCDs with multiple audio channels.

- Press **AUDIO** repeatedly to select the available audio languages.

For VCD – changing the audio channel

- Press **AUDIO** repeatedly to select the available audio channels provided by the disc (STEREO, MONO LEFT, MONO RIGHT or MIX MONO).

Setting the delay times for audio playback

This feature allows you to adjust the audio delay times if the video playback is slower than the audio output streams, which is called 'Lip-sync'. The only way to correct 'Lip-sync' error caused by delayed video is to delay audio by an equal amount.

- 1 Press **AUDIO SYNC**.
- 2 Within five seconds, use the **VOL** + – to set the audio output delay times (0 ~ 150 ms).
→ If the volume control is not used within five seconds, it resumes normal volume control function.

Playback Control (VCD only)

Playback Control (PBC) playback allows you to play Video CDs interactively, following the menu on the display. This function can also be accessed via the 'Preference Page' menu.

For VCDs with Playback Control (PBC) feature (version 2.0 only)

- During playback, press **TITLE** ↵ to return to the disc title menu or main menu.
- During playback, press **DISC MENU** to turn on or off the PBC mode.

Disc Operations (continued)

Playing a MP3/WMA disc

This unit can playback most of the MP3 and Windows Media™ Audio files recorded on a recordable disc or commercial CD.

Before you start ...

Turn on your TV to the correct Video In channel. See 'Finding the correct viewing channel' for details.

- 1 Insert a MP3/WMA disc.
→ The disc reading time may exceed 30 seconds due to the complexity of the directory/file configuration.
→ The disc menu appears on the TV.

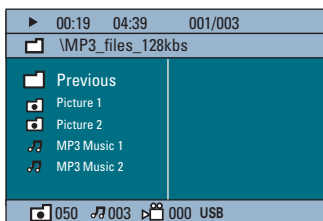

- 2 If the disc main menu contains various folders, use cursor up/down keys to select a desired folder and press **OK** to open the folder.
- 3 Use cursor up/down keys to select a track/file and press **OK** to start playback.
→ Playback starts from the selected file and continues through to the end of the folder.

During playback;

- Press **◀◀/▶▶** to playback another track/file in the current folder.
- Press and hold **◀◀/▶▶** to fast reverse/forward search for a music track.
- To select another folder from the current disc, press cursor up key to return to the root menu.
- Press **REPEAT/SHUFFLE** repeatedly to access various play modes.
- 4 To stop playback, press **■**.

Helpful Hints:

- To skip the folders menu when you load a MP3/JPEG disc, set the MP3/JPEG NAV setting in the Preference Setup Page to { Without Menu }.
- Only the first session of a multi-session CD will be played back.
- It is normal to experience an occasional 'skip' while listening to your MP3/WMA disc due to poor clarity of digital contents during internet downloading.
- If any special characters are present in the MP3 track name (ID3) or album name, it might not be displayed correctly on the screen because this unit does not support the characters.

Disc Operations (continued)

Playing a JPEG image file (slide show)

Before you start ...

Turn on your TV to the correct Video In channel. See 'Finding the correct viewing channel' for details.

- Insert a JPEG photo CD (Kodak Picture CD, JPEG).
 - For a Kodak disc, the slide show begins automatically.
 - For a JPEG disc, the picture menu appears on the TV. Press ►|| to start the slide-show playback.

Helpful Hint:

– It may require longer time for this unit to display the disc content on the TV due to the large number of songs/pictures compiled into one disc.

Supported file format:

- The file extension has to be '*.JPG' and not '*.JPEG'.
- This unit can only display digital camera pictures according to the JPEG-EXIF format, typically used by almost all digital cameras. It cannot display Motion JPEG, progressive JPEG and other JPEG formats, or pictures in formats other than JPEG, or sound clips associated with pictures.

Preview function

- ① During playback, press ■.
 - 12 thumbnail pictures will be displayed on the TV.

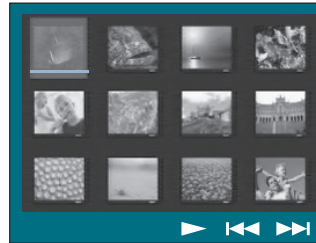

- ② Press ◀◀ / ▶▶ to display the other pictures on the previous/next page.
- ③ Use the cursor keys to select one of the pictures and press OK to start playback.
- ④ Press **DISC MENU** to return to Picture CD menu.

Zoom picture

- ① During playback, press **ZOOM** repeatedly to select a different zoom factor.
- ② Use the cursor keys to pan through the zoomed image.

Rotating/flipping the picture

- During playback, use the cursor keys to rotate/flip the picture on the TV.
 - cursor up: flip the picture vertically.
 - cursor down: flip the picture horizontally.
 - cursor left: rotate the picture counter-clockwise.
 - cursor right: rotate the picture clockwise.

Disc Operations (continued)

Playing MP3/WMA music and JPEG pictures simultaneously

You can create a musical slide show if the disc contains both the MP3/WMA music and JPEG picture files.

- 1 Insert a MP3/WMA that contains music and picture folders.
- 2 Select a track in the menu and press ►|| to start playback.
- 3 During music playback, use the cursor keys to select a picture folder from the disc menu and press ►||.
 - The picture files will be played back through to the end of the folder.
 - The music keeps playing back and will be repeated if reaches the end of the selected album, playlist or track.
- 4 To stop simultaneous playback, press **DISC MENU** followed by ■.

Playing a DivX disc

This unit supports the playback of DivX movies which you can copy from your computer onto a recordable disc. See 'Setup Menu Options - { General Setup Page - DivX(R) VOD code }' for details.

- 1 Insert a DivX disc.
- 2 Use the cursor keys to navigate to the title you want to play.
- 3 Press ►|| to start playback.

During playback;

- If the DivX disc has multilingual subtitles, you can press **SUBTITLE** on the remote control to change the subtitle language.
- If the DivX title has different audio tracks, you can press **AUDIO** on the remote control to change the audio stream.
- Use the cursor left/right keys on the remote control to perform fast reverse/forward search.
- For DivX Ultra disc only, press **DISPLAY** to view the video information.

Helpful Hints:

- Subtitle files with the following file name extensions (.srt, .smi, .sub, .ssa, .ass) are supported but do not appear on the file navigation menu.
- The subtitle file name has to be the same as the file name of the movie.
- The subtitle can only be displayed up to an average of 45 characters.

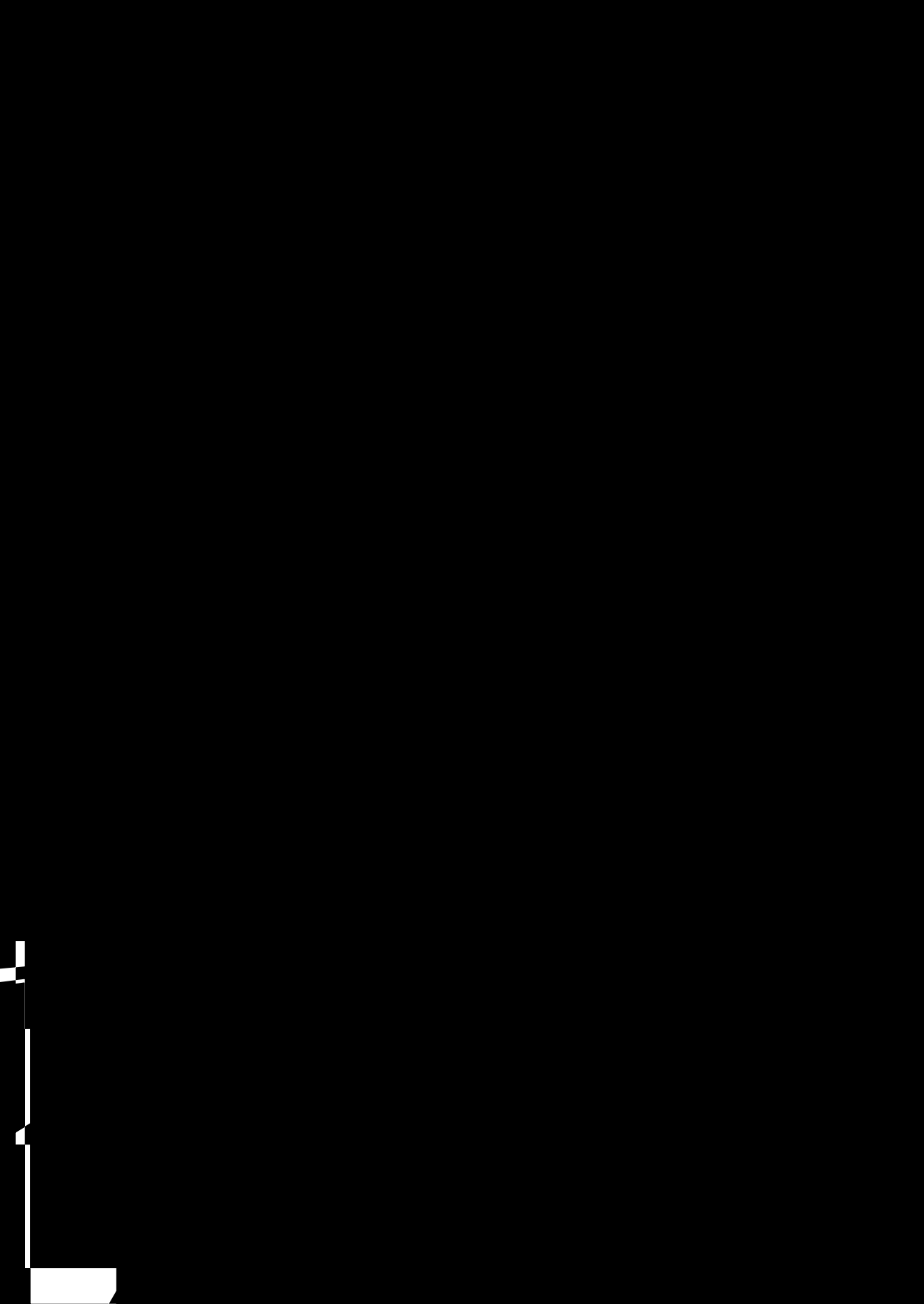

Playback - USB Device

Playing from USB flash drive or USB memory card reader

You can play or view the data files (JPEG, MP3, Windows Media™ Audio or DivX) in the USB flash drive or USB memory card reader. However, editing or copying the data file is not possible.

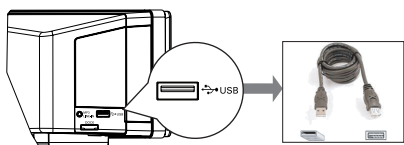

- 1 Connect the USB flash drive / USB memory card reader directly to the **USB** socket on this unit.
- 2 A message appears on the TV for 5 (five) seconds when the device is detected.

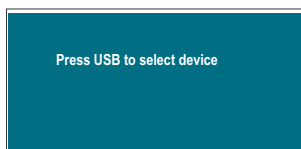

- 3 Press **USB** on the remote control to access the data in the drive.
 - When using multiple drives on a single card reader, only one of the connected cards can be accessed.
 - The device numbers may vary from different card readers.

- 4 Select the file to play and press **▶||**.
 - For more playback information, see 'Playing a MP3/WMA disc', 'Playing a JPEG image file (slideshow)' or 'Playing a DivX disc' for details.
- 5 Before removing the USB device, press **■** to stop playback or press **DISC** to switch to disc mode.

Helpful Hints:

- The USB socket does not support the connection of other USB devices except to a USB flash drive / USB memory card reader.
- When the USB device does not fit into the USB socket, a USB extension cable is required.
- You can only read and playback the content from the USB device.
- Copy-protected contents are not playable.

Playback - Other Audio Player

Playing from other portable audio player

When you connect your portable audio player to this unit to get the best immersion sound experience through the speaker system. However, controlling of playback is only possible on the portable audio player.

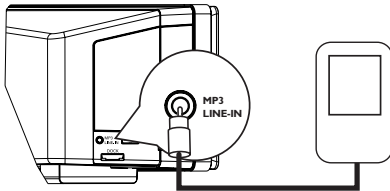

- 1 Use the supplied MP3 LINE-IN cable to connect between the 'headphone' output socket on your portable audio player and the **MP3 LINE-IN** socket on this unit.
- 2 Press **MP3 LINE-IN** on the remote control.
- 3 Start playback on your portable audio player.
→ The music will be heard through the speakers.
- 4 To stop playback, press the STOP button on the portable audio player.

Helpful Hint:

– If you change the input source by pressing any of the source buttons (e.g. DISC, USB, RADIO), press the STOP button on the portable audio player to stop its playback.

Setup Menu Options (continued)

General Setup Page (underlined options are the factory default settings)

- Ambisound Setup** Access the speaker setup options.
- { **Room Acoustics** } – Select the type of walls that surround your room.
 - { **Room Placement** } – Select the placement position.
 - { **Height** } – Select the height where it is placed.
 - { **Distance** } – Select the distance from the listening position.
- Disc Lock** Not all discs are rated or coded by the disc maker. You can prevent play of specific discs with the disc lock function. Up to 40 discs can be locked.
- { **Lock** } – To block the playback of the current disc. Subsequent access to a locked disc requires a four-digit password. The default password is '0000' (see { Preference Setup Page - Password }).
 - { **Unlock** } – All discs can be played.
- Display Dim** Select the brightness of this unit's display panel.
- { **100%** } – Full brightness.
 - { **70%** } – Medium brightness.
 - { **40%** } – Dimmest display. This switches off all LEDs and icons on the front display panel of this unit.
- OSD Language** Select the menu language for this unit's on-screen display.
- Screen Saver** The screen saver prevents damage to the TV screen by avoiding exposure to a static image for too long.
- { **On** } – Switch to TV screen saver mode when playback has been stopped or paused for more than 15 minutes.
 - { **Off** } – Turn off the screen saver function.
- Sleep** The sleep timer enables the unit to switch to standby mode automatically after the selected preset time.
- { **15/30/45/60 mins** } – Select the preset minutes for switching the unit to standby mode automatically.
 - { **Off** } – Turn off the sleep mode function.
- DivX(R)VOD Code** Philips provides you with the DivX® VOD (Video On Demand) registration code that allows you to rent or purchase videos from DivX® VOD service at www.divx.com/vod. All the downloaded videos from DivX® VOD can only be played back on this unit.
- Press cursor right key to see the registration code and press **OK** to exit.

Setup Menu Options (continued)

Audio Setup Page (underlined options are the factory default settings)

HDMI Audio

This setting is only required if you are using the HDMI OUT socket to connect your TV or other display device (see 'Option 2: Connecting to a HDMI-compatible TV').

{ Digital Audio }

{ Off }

Turn off the HDMI audio output. You can still enjoy sound output via the speaker system.

{ All }

The HDMI audio output will be same as the audio stream being played back. In the case when the playback audio format is not supported, the audio output will be changed to PCM automatically.

{ PCM only }

Downmix the audio signals to linear-PCM (2-channel).

Notes:

- It may take a while for this unit and the input device to communicate and initialise.
- It is not possible to listen to SACDs or copy-controlled DVD-Audio CPPM (Content Protection for Playable Media) sources using the HDMI connection.

Setup Menu Options (continued)

Video Setup Page (underlined options are the factory default settings)

TV Type

Select the colour system that matches the connected TV. It enables playback of a different type of disc (PAL or NTSC disc) on this unit.

- { **PAL** } – For PAL-system TV.
- { **NTSC** } – For NTSC-system TV.
- { **Multi** } – For TV that is compatible with both PAL and NTSC.

TV Display

The picture shape can be adjusted to fit your TV.

{ **4:3 Pan Scan** } – For a full-height picture with the sides trimmed.



{ **4:3 Letter Box** } – For a 'wide-screen' display with black bars on the top and bottom.



{ **16:9 Wide Screen** } – For wide-screen TV (frame ratio 16:9).



Picture Setting

This unit provides three predefined sets of picture colour settings and one personal setting which you can define yourself.

- { **Standard** } – Original colour setting.
- { **Bright** } – Vibrant colour setting.
- { **Soft** } – Warm colour setting.
- { **Personal** } – Select this to personalise the picture colour setting. Use the cursor left/right keys to adjust to the setting that best suits your personal preference and press **OK** to confirm. For an average setting, select { 0 }.

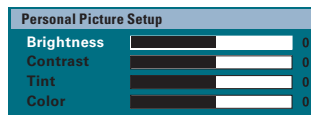

Setup Menu Options (continued)

Video Setup Page (underlined options are the factory default settings)

Component

Select the type of video output that matches the video connection between this unit and your TV.

- { **YUV** } – For component video (Y Pb Pr) connection.
- { **RGB** } – For SCART connection.

Progressive

Before enabling the progressive scan feature, you must ensure that your TV can accept progressive signals (a progressive scan TV is required) and that you have connected this unit to your TV using the Y Pb Pr. See 'Getting Started - Setting up the progressive scan feature' for details.

- { **On** } – Turn on progressive scan mode.
Read the instructions on the TV and confirm your action by pressing **OK** on the remote control.
- { **Off** } – Turn off the progressive scan mode.

Adv Picture

It provides the picture settings to enhance the appearance and picture quality for disc playback.

Note: { DCDi }, { True Life } and { P-Scan Format } settings are only applicable for Progressive Scan output.

- { **DCDi** } – Directional Correlation Deinterlacing. It is known by its smooth video content as it fills the missing lines.
 - { **On** }
Optimise the picture quality significantly, especially during the slow motion play.
 - { **Off** }
Turn off the DCDi function.
- { **Gamma** } – Adjust the intensity of the picture non-linearly (-7 to +7). A positive value enables you to bring out low level detail in dark scenes, while a negative value emphasises contrast.
- { **Chroma Delay** } – Adjust the advance delay of chroma signal to produce a perfect clear picture (-3 to +3).
- { **True Life** } – Increase the contrast and colour intensity to produce a more dynamic picture (00 to 05).

Setup Menu Options (continued)

Video Setup Page (underlined options are the factory default settings)

Adv Picture

continued ...

{ **HDMI Video** } – Select a suitable video resolution depending on the capability of the connected TV/device to further enhance the HDMI video output.

{ **480p** }

Progressive output in 480 lines for NTSC TV.

{ **576p** }

Progressive output in 576 lines for PAL TV.

{ **720p** } - (if a HDMI TV is connected)

Progressive output upscale to 720 lines.

{ **1080i** } - (if a HDMI TV is connected)

Interlaced output upscale to 1080 lines.

{ **1080p** } - (if a HDMI TV is connected)

Progressive output upscale to 1080 lines.

{ **Auto** }

The video output automatically follows the display's supported resolution.

Note: If no display appears on the TV due to unsupported resolution, use the Scart cable to connect this unit and your TV. Turn on your TV to the correct video input channel and adjust the resolution setting to 480p/576p.

{ **P-Scan Format** } – Select a suitable TV screen display format.

Note: This feature is only available if you have selected the { **16:9 Wide Screen** } in { **TV Display** } setup option.

{ **Superwide** }

Display the 4:3 picture disc on the wide-screen TV with non-linear stretching (centre position of the screen is stretched less than the side).

{ **4:3 Pillar Box** }

Display the 4:3 picture disc on the wide-screen TV without stretching. Black bars will be shown on the both sides of the TV screen.

{ **Off** }

No aspect ratio adjustment is made when this option is selected.

Note: The { **Superwide** } is only applicable for resolution: 720p, 1080i or 1080p.

Setup Menu Options (continued)

Preference Setup Page (underlined options are the factory default settings)

- Audio** Select the preferred audio language for DVDs with multiple sound tracks or VCDs with multiple audio channels.
- Subtitle** Select the preferred subtitle language for DVD playback.
- Disc Menu** Select the preferred disc menu language for DVD playback.
- Note:** If the selected audio/subtitle/disc menu language is not available on the DVD, the disc's default language will be used instead.
- Parental** This is to prohibit viewing of discs that had exceeded the limits you set. It works only on the DVDs with parental level assigned to the complete disc or to certain scenes on the disc.
- 1) Use cursor up/down keys to select a rating level from 1 to 8 and press **OK**.
 - 2) Use the **numeric keypad 0-9** on the remote control to enter your four-digit password.
- Notes:**
- The ratings are country-dependent ('1' is considered material that is least offensive and '8' is most offensive). To disable parental controls and allow all discs to play, select '8'.
 - Some DVDs are not encoded with a rating though the movie rating may be printed on the disc cover. The rating level feature does not prohibit playback of such discs. VCD, SVCD and CD have no level indication, so parental control has no effect on these type of discs.
 - DVDs that are rated higher than the level you selected will not be played unless you enter the same four-digit password.
- PBC** Play Back Control feature is applicable for VCD/SVCD only. It allows you to play Video CDs (2.0) interactively, following the menu on the display.
- { **On** } – The index menu (if available) appears on the TV when you load a VCD/SVCD.
 - { **Off** } – The VCD/SVCD skips the index menu and playback directly from the beginning.
- MP3/JPEG Nav** MP3/JPEG Navigator can only be set if the disc is recorded with a menu. It allows you to select different display menus for easy navigation.
- { **Without Menu** } – Display all the files contained in the MP3/Picture disc.
 - { **With Menu** } – Display the folder menu of the MP3/Picture disc.
- Note:** This unit can only display 650 files/folder in the directory.

Setup Menu Options (continued)

Preference Setup Page (underlined options are the factory default settings)

Password

The password is used for the Disc Lock and Parental. The default password is '0000'. To change the password:

1) Press **OK** to access the change password menu.

The screenshot shows a menu titled 'Change Password' with a dark blue background. It contains three text input fields: 'Old Password', 'New Password', and 'Confirm PWD'. Below these fields is a light blue button labeled 'OK'.

2) Use the **numeric keypad 0-9** on the remote control to enter your existing four-digit password at { Old Password }.

Note: When doing this for the first time or if you forget your existing password, key in '0000'.

3) Enter the new four-digit password at { New Password }.

4) Enter the new four-digit password again at { Confirm PWD }.

5) Press **OK** to confirm and exit the menu.

DivX Subtitle

Select the font type that supports the recorded DivX subtitle.

{ **Standard** } – Display a standard list of Roman subtitle fonts provided by this unit.

{ **Central Europe** } – Display Central Europe fonts.

{ **Cyrillic** } – Display Cyrillic fonts.

Default

This feature enables you to reset all the setup menu options and your personal settings to the factory defaults, except your password for the Disc Lock and Parental.

Press **OK** to confirm the default reset.

start
the FM
d.

to rad

SOURCE re
rs on the

(the remote control).

- Using

ight keys briefly on the
start tuning.

Helpful H

'<' appears on the
radio station with
length is found.

- This u

necessary until you
station.

ception of a weak
ursor up/down keys
lly until optimal

eo and FM
the



Radio Operations (continued)

- Press **▶II**.
 - This unit starts searching from the FM band followed by the AM band.
 - All the available radio stations with strong signal will be stored automatically.
 - Once complete, the first tuned radio station will be played back.

Using automatic preset

Use automatic presetting to store or reinstall all the preset radio stations.

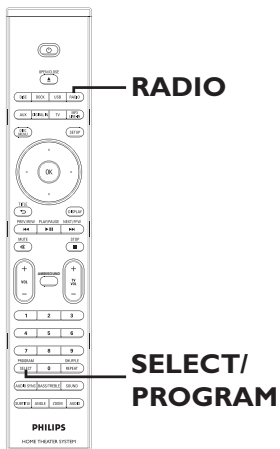

- Press **RADIO** to select 'FM' or 'AM' band.
- Press and hold **SELECT/PROGRAM** until 'INSTALLN IN PROG' appears on the display panel.
 - All previously stored radio stations will be replaced.

Using manual preset

Use manual presetting to store your favourite radio stations.

- Tune to your desired radio station (see 'Tuning to radio stations').
- Press **SELECT/PROGRAM**.
- Use **◀◀/ ▶▶** keys to select a preset number that you want to store the current radio station.
- Press **SELECT/PROGRAM** to store.

Selecting a preset radio station

- Press **RADIO** to select 'FM' or 'AM' band.
- Use **◀◀/ ▶▶** keys to select a preset number (or use the numeric keypad on the remote control).
 - The waveband, preset number followed by the radio frequency appear on the display panel.

Deleting a preset radio station

- In radio mode, use **◀◀/ ▶▶** keys to select a preset radio station.
- Press and hold **■** until 'FM/AM X DELETED' appears.
 - 'X' is the preset number.
 - The radio station continues to play but has been deleted from the preset list.
 - The rest of the preset radio stations remain unchanged.

Sound and Volume Controls

Volume control

- Press **VOL + / -** to increase or decrease the volume level.
→ 'VOLUME MIN' is the minimum volume level and 'VOLUME MAX' is the maximum volume level.

To turn off the volume temporarily

- Press **MUTE**.
→ Playback continues without sound and 'VOLUME MUTED' appears.
→ To restore the volume, press **MUTE** again, or increase the volume level.

Adjusting the Bass/Treble level

The **BASS** (low tone) and **TREBLE** (high tone) features enable you to define the sound processor settings.

- 1 Press **TREBLE/BASS** to toggle between Treble and Bass mode.
- 2 Within five seconds, use the **VOL + -** to adjust the Treble or Bass level.
→ If the volume control is not used within five seconds, it resume normal volume control function.

Selecting surround sound

- Press **AMBISOUND** to select between Auto, Multi-channel or Stereo sound.
→ 'Auto' is the default surround setting (recommended). Multi-channel or Stereo will be selected based on the audio stream of the played content.
→ The available output modes for Multi-channel include: Dolby Digital, DTS (Digital Theater Systems) Surround and Dolby Pro Logic II.

Selecting digital sound effects

Select a preset digital sound effect that matches your disc's content or that optimizes the sound of the musical style you are playing.

- Press **SOUND** to select the available sound effect.

Movies	Music	Description
ACTION	ROCK	Enhanced low and high range for great sounding movie effects and atmosphere. Great for action movies and rock/pop music.
DRAMA	JAZZ	Clear mid and high range. Recreates the atmosphere of a live club with the artist just in front of you. Good for Jazz music and watching dramas.
GAMING	PARTY	Slightly enhanced low range and strong mid range ideal for party music and video gaming.
CONCERT	CLASSIC	Flat and pure sound mode. Ideal for listening to classical music and watching live concert DVDs.
MTV	RnB	Enhanced low and mid range for groovy and punchy sounds. Suitable for R&B, Hip Hop and MTV videos.
CARTOONS	LOUNGE	Moderate sound mode suitable for lounge music and watching cartoons.
SPORTS	SPORTS	Moderate mid range and surround effects for clear vocals and the atmosphere of a live sports venue.
NEWS	NEWS	Enhanced mid range for clear vocals/speech.

Other Features

Installing the latest software

Periodically Philips will issue software upgrades to enhance the user experience.

- 1 Get the software version of this unit by pressing **OPEN/CLOSE**  to open the disc compartment
- 2 Press **DISPLAY** on the remote control.
→ Write down the information for your current software version.
- 3 Visit the Philips website 'www.philips.com/support' to check the availability of the latest software upgrade and download the software to a CD-R.
- 4 Insert the CD-R to the disc tray.
→ The software starts to install on this unit automatically.

Note:

Never unplug or turn off this unit during the upgrade.

- 5 When the disc compartment opens, remove the CD-R.
→ The software upgrading is in process. Leave the disc compartment open.
- 6 Wait until the disc compartment closes automatically, you can now power off and on the unit.

WARNING

Under no circumstances should you try to repair this unit yourself, as this will invalidate the warranty. Do not open this unit as there is a risk of electric shock.

If a fault occurs, first check the points listed below before taking this unit for repair. If you are unable to solve a problem by following these instructions, consult your dealer or Philips for help.

Problem (General)	Solution
No power.	<ul style="list-style-type: none"> – Press STANDBY-ON on the unit to turn on the power. – Ensure that the interconnect cable between the subwoofer and main unit are connected.
No picture.	<ul style="list-style-type: none"> – Refer to your TV's manual for correct Video In channel selection. Change the TV channel until you see the blue DVD screen. – Press DISC to select disc mode. – If this happens when you turn on the progressive scan feature or change the HDMI video setting, wait for 15 seconds for the auto recovery or switch back to the default mode as below: <ol style="list-style-type: none"> 1) Press OPEN/CLOSE to open the disc compartment. 2) Press cursor left key on the remote control. 3) Press AUDIO on the remote control.
Completely distorted picture or black/white picture.	<ul style="list-style-type: none"> – Check the video connection. – Sometimes a small amount of picture distortion may appear. This is not a malfunction. – The disc is dirty. Clean the disc.
No sound or distorted sound.	<ul style="list-style-type: none"> – Adjust the volume. – Check the speaker connections and settings. – Make sure that the audio cables are connected and press SOURCE to select the correct input source (for example, TV or AUX) to choose the device that you want to hear through this unit.
No surround sound effect from the speakers.	<ul style="list-style-type: none"> – Press AMBISOUND to select a correct surround sound setting. – Make sure that the source you are playing is recorded or broadcast in surround sound (DTS, Dolby Digital, etc.).
The remote control does not function properly.	<ul style="list-style-type: none"> – Select the source you want to play (for example, DISC or RADIO) before pressing the function button (▶, ◀◀ / ▶▶). – Reduce the distance between the remote control and this unit. – Batteries are weak, replace the batteries.

Troubleshooting (continued)

English

Problem (Playback)	Solution
This unit does not start playback.	<ul style="list-style-type: none">– Insert a readable disc with the playback side facing inwards. The DVD+R/CD-R must be finalised.– Make sure the disc is not scratched or warped.– Press SETUP to turn off the system setup menu screen.– You may need to enter the password in order to unlock the disc for playback.– Moisture may have condensed inside this unit. Remove the disc and leave this unit turned on for about an hour.
The aspect ratio of the screen cannot be changed even though you have set the TV display.	<ul style="list-style-type: none">– The aspect ratio is fixed on the DVD disc.– Depending on the TV, it may not be possible to change the aspect ratio.
Cannot activate some features such as Angles, Subtitles, or multi-language Audio.	<ul style="list-style-type: none">– The features may not be available on the DVD.– Changing the language for the sound or subtitle is prohibited on this DVD.
Not able to select some items in the setup/system menu.	<ul style="list-style-type: none">– Press STOP button twice before selecting the system setup menu.– Depending on the disc availability, some menu items cannot be selected.
Unable to play DivX movies.	<ul style="list-style-type: none">– Ensure that the DivX file is encoded according to the 'Home Theatre Profile' with the DivX encoder.– Check that the DivX movie downloaded is a complete file.
Radio reception is poor.	<ul style="list-style-type: none">– If the signal is too weak, adjust the antenna or connect an external antenna for better reception.– Increase the distance between this unit and your TV or VCR.– Tune in to the correct frequency.– Place the antenna further away from any equipment that may be causing the interference.
This unit does not work.	<ul style="list-style-type: none">– Disconnect the power cord from the power outlet for a few minutes. Reconnect the power cord and try to operate again as usual.– Ensure that the interconnect cable between the subwoofer and main unit are connected.

Troubleshooting (continued)

Problem (USB/HDMI/Dock Station)	Solution
The contents of the USB flash drive cannot be read.	<ul style="list-style-type: none">- The USB flash drive format is not compatible with this unit.- Drive is formatted with a different file system which is not supported by this unit (e.g. NTFS).
Slow operation of the USB flash drive.	<ul style="list-style-type: none">- Large file size or high memory USB flash drive takes longer time to read and display on the TV.
No audio output from HDMI connection.	<ul style="list-style-type: none">- You will not hear any sound from the HDMI output if the source device is only DVI/HDCP (High-bandwidth Digital Content Protection)-compatible.- It is not possible to output SACD or copy-controlled DVD-Audio sources from the HDMI connection.- Make sure that the audio output setting is not turned off. See 'Setup Menu Options - { Audio Setup Page - HDMI Audio }' for details.
No video output from HDMI connection.	<ul style="list-style-type: none">- HDMI connection can only be made to HDMI-equipped devices with HDCP (High Bandwidth Digital Content Protection). If you wish to connect to a DVI connector (equipped with HDCP), you will need a separate adaptor (DVI to HDMI).- Make sure the resolution of this unit matches the device you have connected using the HDMI. See 'Setup Menu Options - { Video Setup Page - HDMI Setup - HDMI Video }' for details.
No picture after changing the HDMI video resolution.	<ul style="list-style-type: none">- Your TV cannot support the current HDMI video resolution. Switch the HDMI video resolution to the next setting by holding down the SELECT/PROGRAM on the remote control for more than 3 seconds repeatedly until the picture appears on the TV again.
No video from iPod playback.	<ul style="list-style-type: none">- Make sure you have connected the 3.5mm video cable from the docking station to your TV. Turn on your TV to the correct video input channel.- Turn on the 'TV ON' setting of the iPod.
'NONE DOCKED' appears on the display panel.	<ul style="list-style-type: none">- Remove the GoGear/iPod from the docking cradle and reinsert again.- If the battery level of your GoGear/iPod is totally drained, you have to charge it again before use.

Frequently Asked Questions (USB)

Why does it take so long to display the contents on my USB device?

- This could be due to the large numbers of files (>500 files/folders) or size of the files (>1MB).
- There could be other non-supported files in the device that this unit is trying to read/display.

What if unsupported devices (e.g. USB mouse, keyboards) are plugged into the unit?

The device may cause this unit to be unstable. Remove the unsupported device and unplug the mains cord. Wait for a few minutes before reconnecting the mains cord and power on this unit again.

What happens when I plug in a USB HDD?

HDD is not supported as the large storage capacity makes navigation very difficult. Transfer the music files (mp3) and photos (jpg) into a flash drive.

Why does this unit fail to detect my USB portable music player?

The portable music player may require propriety software that is bundled with our system in order to access the contents (eg. playlist). MTP class not supported, only can support mass storage class devices.

What types of file does this unit support?

We support only FAT16 and FAT32, not NTFS.

Why does the file name appear to be different from what was displayed on my computer (e.g. from “Good Bye. jpg” to “Good_B~1.jpg”)?

- The length of the file name is restricted by the file system of the device (FAT16), which only supports eight (8) characters.
- The computer may be able to display the full file name as the operating system can convert the file system.

Is simultaneous USB and Disc playback possible?

This is not possible due to memory limitation. In addition, a different user interface will be needed in order to function and in order to be simple enough to use.

Why can't I rotate the pictures in my device?

In order to rotate the pictures in the USB device, the picture must contain EXIF information, stored by most digital cameras. This EXIF information may have been removed when you edit or copy the picture from other devices using editing programmes.

Why can't this unit play some of my music files, photos or movies?

The music files may not be playable because of different formats and encoding bit-rates. Similarly, the photos may be of low resolution or too high resolution for this unit to support.

Specifications

AMPLIFIER

Frequency Response: 20 Hz – 20 kHz / -3 dB

Signal-to-Noise Ratio: > 65 dB (CCIR)

Input Sensitivity

- AUX 1&2 In: 1000 mV
- TV 1&2 In: 500 mV
- Digital In: 500 mV
- MP3 Line In: 250 mV

* (1% THD 1kHz)

RADIO

Tuning Range: FM 87.5–108 MHz (50 kHz)
MW 531–1602 kHz (9 kHz)

26 dB Quieting

Sensitivity: FM 20 dBf, MW 4µV/m

Image Rejection Ratio: FM 25 dB, MW 28 dB

IF Rejection Ratio: FM 60 dB, MW 45 dB

Signal-to-Noise Ratio: FM 60 dB, MW 40 dB

MW Suppression Ratio: FM 30 dB

Harmonic Distortion: FM Mono 3%

FM Stereo 3%

MW 5%

Frequency Response FM 180 Hz–10 kHz / ±6 dB

Stereo Separation FM 26 dB (1 kHz)

Stereo Threshold FM 23.5 dB

DISC

Laser Type Semiconductor

Disc Diameter 12cm / 8cm

Video Decoding MPEG-1 / MPEG-2 /
/ DivX 3/4/5/6, Ultra

Video DAC 12 Bits

Signal System PAL / NTSC

Video Format 4:3 / 16:9

Video S/N 56 dB (minimum)

Component Video Output

(Y) 1.0 V_{p-p}, 75Ω

(Pb) 0.7 V_{p-p}, 75Ω

(Pr) 0.7 V_{p-p}, 75Ω

Audio DAC 24 Bits / 192 kHz

Frequency Response 4 Hz–20 kHz (44.1 kHz)

4 Hz–22 kHz (48 kHz)

4 Hz–44 kHz (96 kHz)

PCM IEC 60958

Dolby Digital IEC 60958, IEC 61937

DTS IEC 60958, IEC 61937

MAIN UNIT

Dimensions: 935 x 146 x 136 (mm)
(w x h x d)

Weight: 7.2 kg

Speaker system Closed-box system

Centre Speaker

Speaker Impedance: 4ohm

Speaker drivers: 2 x 2.5" woofer + 2 x 25mm
soft dome tweeter

Frequency response: 200 Hz - 20 kHz

Left/Right Surround Speakers

Speaker Impedance: 6ohm

Speaker drivers: 2 x 2.5" full-range speaker

Frequency response: 200 Hz - 20 kHz

SUBWOOFER

Power Supply Rating: 220–240 V; 50–60 Hz

Power Consumption: 120 W

Low Standby power: < 0.6 W

System: Bass Reflex System

Impedance: 4 Ω

Speaker drivers: 165 mm (6 1/2") woofer

Frequency response: 35 Hz – 200 Hz

Dimensions: 295 x 470 x 295 (mm)
(w x h x d)

Weight: 11.2 kg

Specifications subject to change without prior notice.

Glossary

Analogue audio: Sound that has not been turned into numbers. Analogue sound is available with you use the AUDIO LEFT/ RIGHT. These red and white sockets send audio through two channels, the left and right.

Aspect ratio: Aspect ratio refers to the length to height ratio of TV screens. The ratio of a standard TV is 4:3, while the ratio of a high-definition or wide TV is 16:9. The letter box allows you to enjoy a picture with a wider perspective on a standard 4:3 screen.

AUDIO OUT sockets: Red and white sockets on the back of the unit that send audio to another system (TV, Stereo, etc.).

Bit Rate: The amount of data used to hold a given length of music; measured in kilobits per second, or kbps. Or, the speed at which you record. Generally, the higher the bit rate, or the higher the recording speed, the better the sound quality. However, higher bit rates use more space on a disc.

Chapter: Sections of a picture or a music piece on a DVD that are smaller than titles. A title is composed of several chapters. Each chapter is assigned a chapter number enabling you to locate the chapter you want.

Disc menu: A screen display prepared for allowing a selection of images, sounds, subtitles, multi-angles, etc., recorded on a DVD.

DivX: The DivX code is a patent-pending, MPEG-4 based video compression technology, developed by DivX Networks, Inc., that can shrink digital video to sizes small enough to be transported over the internet, while maintaining high visual quality.

Dolby Digital: A surround sound system developed by Dolby Laboratories containing up to six channels of digital audio (front left and right, surround left and right, centre and subwoofer).

Dolby Surround Pro Logic II: It is an improved matrix decoding technology that provides better spatiality and directionality on Dolby Surround programme material, provides a convincing three dimensional sound field on conventional stereo music recordings and is ideally suited to bring the surround experience to automotive sound. While conventional surround programming is fully compatible with Dolby Surround Pro Logic II decoders, soundtracks will be able to be encoded specifically to take full advantage of Pro Logic II playback, including separate left and right surround channels. (Such material is also compatible with conventional Pro Logic decoders).

DTS: Digital Theatre Systems. This is a surround sound system, but it is different from the Dolby Digital. The formats were developed by different companies.

HDMI: High-Definition Multimedia Interface (HDMI) is a high-speed digital interface that can transmit uncompressed high definition video and digital multichannel audio. It delivers perfect picture and sound quality, completely free from noise. HDMI is fully backward-compatible with DVI. As required by the HDMI standard, connecting to HDMI or DVI products without HDCP (High-bandwidth Digital Content Protection) will result in no Video or Audio output.

HDCP (High-bandwidth Digital Content Protection) is a specification that provides a secure transmission of digital contents between different devices (to prevent unauthorised copyright).

Glossary (continued)

JPEG: A very common digital still picture format. A still-picture data compression system proposed by the Joint Photographic Expert Group, which features small decrease in image quality in spite of its high compression ratio. Files are recognised by their file extension 'JPG or JPEG'.

MP3: A file format with a sound data compression system. 'MP3' is the abbreviation of Motion Picture Experts Group 1 (or MPEG-1) Audio Layer3. By using the MP3 format, one CD-R or CD-RW can contain about 10 times more data than a regular CD.

MPEG: Motion Picture Experts Group. A collection of compression systems for digital audio and video.

Multi-channel: DVDs are formatted to have each sound track constitute one sound field. Multi-channel refers to a structure of sound tracks having three or more channels.

PBC: Playback Control. A system of navigating a Video CD/Super VCD through on-screen menus recorded onto the disc. You can enjoy interactive playback and searching.

Progressive Scan: The progressive scan displays twice the number of frames per second than in an ordinary TV system. It offers higher picture resolution and quality.

Region code: A system allowing discs to be played only in the region designated. This unit will only play discs that have compatible region codes. You can find the region code of your unit by looking at the product label. Some discs are compatible with more than one region (or ALL regions).

Surround: A system for creating realistic three dimensional sound fields full of realism by arranging multiple speakers around the listener.

Title: The longest section of a movie or music feature on DVD. Each title is assigned a title number, enabling you to locate the title you want.

WMA: Windows Media™ Audio. Refers to an audio compression technology developed by Microsoft Corporation. WMA data can be encoded by using Windows Media Player version 9 or Windows Media Player for Windows XP. Files are recognised by their file extension 'WMA'.

Free Manuals Download Website

<http://myh66.com>

<http://usermanuals.us>

<http://www.somanuals.com>

<http://www.4manuals.cc>

<http://www.manual-lib.com>

<http://www.404manual.com>

<http://www.luxmanual.com>

<http://aubethermostatmanual.com>

Golf course search by state

<http://golfingnear.com>

Email search by domain

<http://emailbydomain.com>

Auto manuals search

<http://auto.somanuals.com>

TV manuals search

<http://tv.somanuals.com>